



Free Downloads of Build Instructions,
Assembly Booklets & How To Guides

BuildInstructions.com

WARHAMMER 40,000

INDOMITUS



READ THIS FIRST | À LIRE EN PRIORITÉ | BITTE BEACHTE | LEE ESTO PRIMERO | LEGGI PRIMA QUESTO | 最初にお読みください。| 请优先阅读

ENG BEFORE ASSEMBLING YOUR MINIATURES, PLEASE READ THROUGH THE INSTRUCTIONS IN THIS BOOKLET CAREFULLY, AND RETAIN THEM FOR FUTURE REFERENCE. Carefully remove the models from the frame, asking an adult for assistance, and push the models together as shown.

FRE AVANT D'ASSEMBLER VOS FIGURINES, LISEZ MINUTIEUSEMENT LES INSTRUCTIONS DE CE LIVRET ET CONSERVEZ-LE POUR VOUS Y REFERER DANS LE FUTUR. Retirez précautionneusement les figurines de la grappe en demandant si nécessaire l'aide d'un adulte, et assemblez les figurines comme indiqué.

ESP ANTES DE MONTAR TUS MINIATURAS, LEE LAS INSTRUCCIONES DE ESTE LIBRETO CUIDADOSAMENTE Y GUÁRDALO PARA FUTURAS REFERENCIAS. Retira las miniaturas de la matriz con cuidado, pide ayuda a un adulto si la necesitas, y monta las miniaturas tal y como se muestra.

GER VOR DEM ZUSAMMENBAU DER MINIATUREN BITTE DIE ANWEISUNGEN IN DIESER ANLEITUNG AUFMERKSAM LESEN UND ZUM SPÄTEREN NACHSCHLAGEN AUFBEWAHREN. Trenne die Modelle vorsichtig aus dem Gussrahmen – frage gegebenenfalls einen Erwachsenen um Hilfe dabei – und stecke sie dann wie dargestellt zusammen.

ITA PRIMA DI ASSEMBLARE LE MINIATURE, LEGGI CON CURA LE ISTRUZIONI DI QUESTO LIBRETTO E CONSERVALE PER CONSULTARLE IN FUTURO. Rimuovi con cura i modelli dallo sprue, chiedendo aiuto ad un adulto, e monta le miniature come mostrato.

日本語 ミニチュアを組み立てる前に、この冊子の説明をよくお読みください。この冊子は将来参照できるように保存されることをお勧めいたします。ランナーからパーツを切り取るときは十分注意して、大人に手伝ってもらいましょう。パーツを押し込むときは図を参考にしてください。

RUS ПЕРЕД ТЕМ КАК СОБРАТЬ ВАШИ МИНИАТЮРЫ ПОЖАЛУЙСТА ВНИМАТЕЛЬНО ПРОЧИТАЙТЕ ИНСТРУКЦИИ В ЭТОМ БУКЛЕТЕ И ЗАПОМНИТЕ ИХ НА БУДУЩЕЕ. Попросите взрослых помочь осторожно вытащить модели из рамки и соединить их вместе как показано.

中文 组装微缩模型前，请仔细阅读手册中的说明，并留存本说明以供日后参考。在成人的协助下，从板件中小心取下模型，并按图示进行组装。

A
x2



B
x2

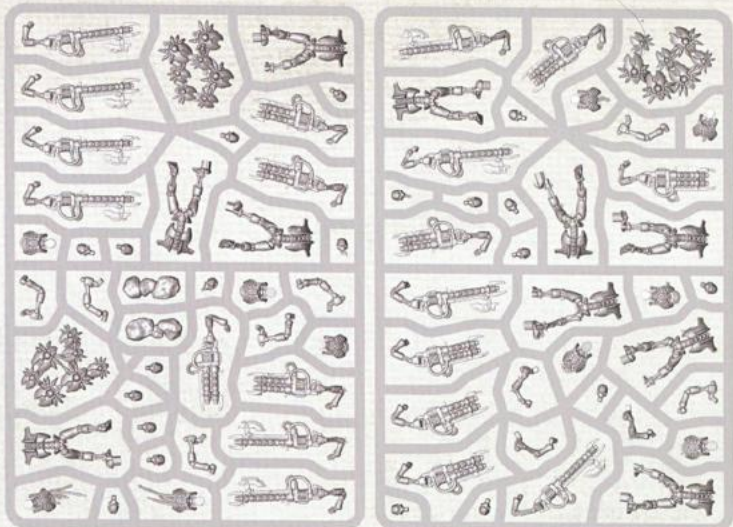

C
x1



D
x1

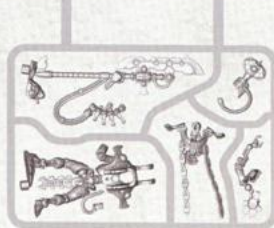

E
x1

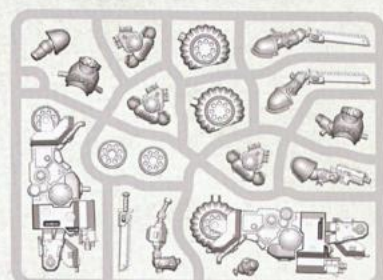

F
x1



∅ 28mm x1



∅ 32mm x34



∅ 40mm x18



∅ 50mm x3



∅ 65mm x2



∅ 90mm x3

G
x1

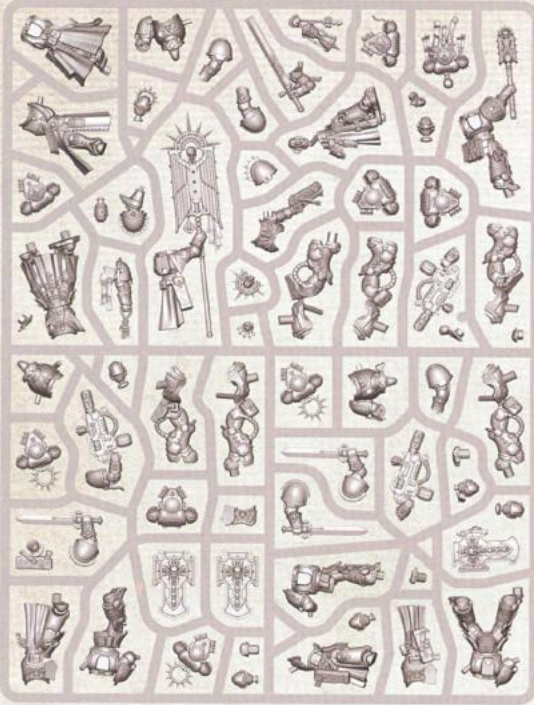

H
x1

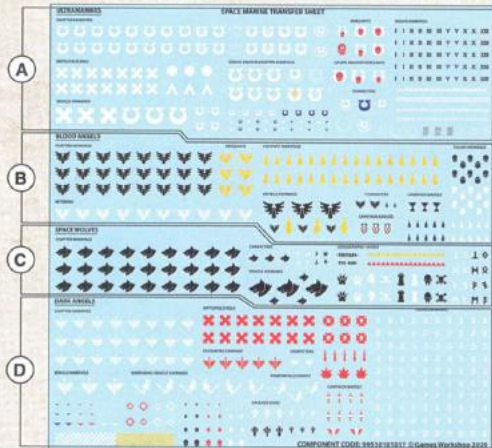
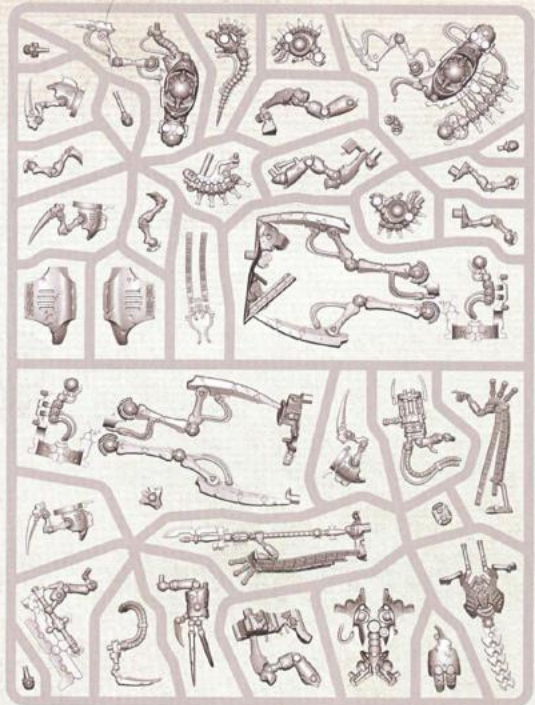

! USE CORRECT BASES | UTILISEZ LES SOCLES APPROPRIÉS | USA LAS PEANAS CORRECTAS | BASEGRÖSSEN BEACHTEN | USA LE BASETTE CORRETTE.
適切なベースサイズ | 使用正統的底座

- Your models are supplied with different-sized bases. Use the diagram on the right to help you to determine which is the correct base for the model you are building.
- Vos figurines sont fournies avec des socles de tailles variées. Utilisez le diagramme ci-contre pour vous aider à déterminer quel est le socle adapté à la figurine que vous assemblez.
- Tus miniaturas se suministran con peanas de diferentes tamaños. Usa el diagrama a la derecha para ayudarte a determinar cuál es la peana correcta para la miniatura que estás montando.
- Für jede Miniatur ist eine bestimmte Basegröße vorgesehen. Mit dem Diagramm rechts kannst du bestimmen, welches Base zu dem Modell gehört, das du gerade zusammenbaust.
- I tuoi modelli sono forniti con basette di dimensioni differenti. Usa l'immagine a destra per aiutarti a determinare qual è la basetta corretta per il modello che stai assemblando.
- ミニチュアにはそれぞれ異なる大きさのベースが付属している。右の図を参考に、組み立て中のミニチュアに対応した適切なベースを使用すること。
- 我们为模型提供了不同尺寸的底座。请使用右侧的图示协助您判断哪种尺寸的底座适合您正在组装的模型。

1:1

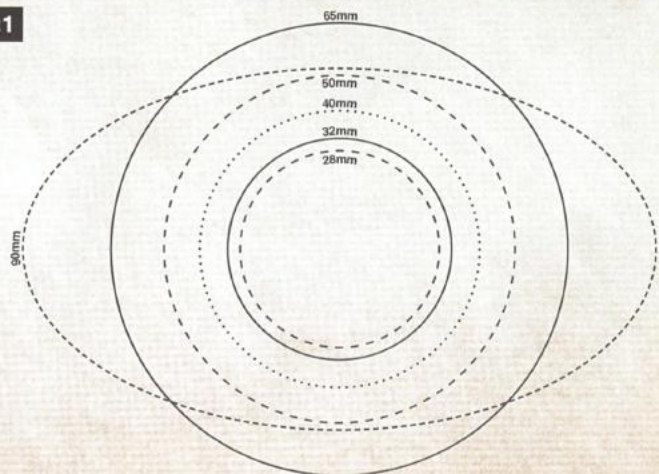

- Variant assembly
- Variante d'assemblage
- Variante de montaje
- Bauvariante
- Assemblaggio alternativo
- 組み立てバリエーション
- 多种组装方式

- Choice of parts
- Choix d'éléments
- Modelos de componentes
- Auswahl an Teilen
- Scelta di componenti
- パーツの選択
- 选择部件

- Repeat process
- Répéter l'étape
- Repetir pasos
- Vorgang wiederholen
- Ripeti il processo
- 同じ作業を繰り返すこと
- 重复步骤

- Stage complete
- Étape terminée
- Paso completado
- Schritt abgeschlossen
- Fase completa
- このステージの完成
- 完成

BUILD VARIANTS | VARIANTES D'ASSEMBLAGE | MONTAJES ALTERNATIVOS | BAUVARIANTEN | VARIANTI D'ASSEMBLAGGIO | バリエーション | 変体版

- Assemblies for build variants are colour coded.
- Les assemblages de variantes ont un code couleur.
- Las instrucciones para montajes alternativos se indican con un color diferente.
- Optionen für Bauvarianten sind farblich markiert.
- Le diverse varianti d'assemblaggio sono divise per colore.
- バリエーション違いの組み立ては色分けされている。
- 変体版拼装部件有颜色区分。

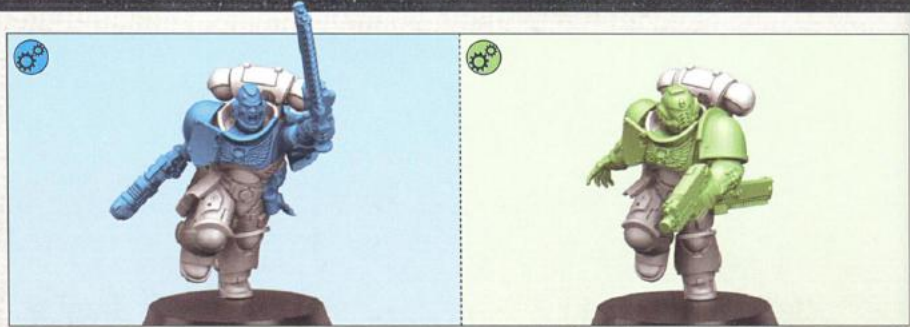

1 PRIMARIS CAPTAIN | CAPITAINE PRIMARIS | CAPITÁN PRIMARIS | PRIMARIS-CAPTAIN | CAPITANO PRIMARIS | プライマリス・キャプテン | 基因原体队长

1 a

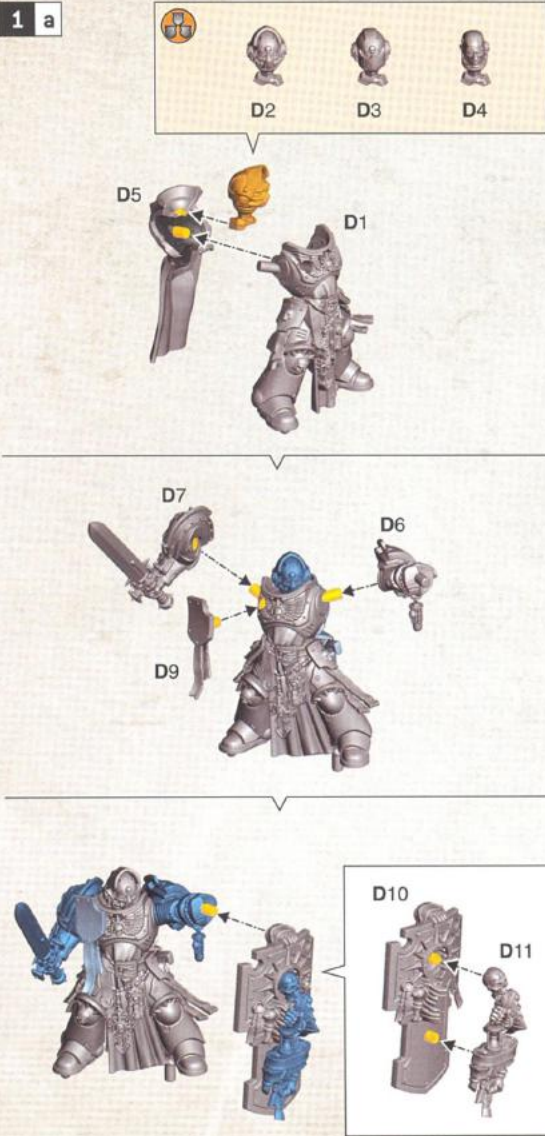

1 b

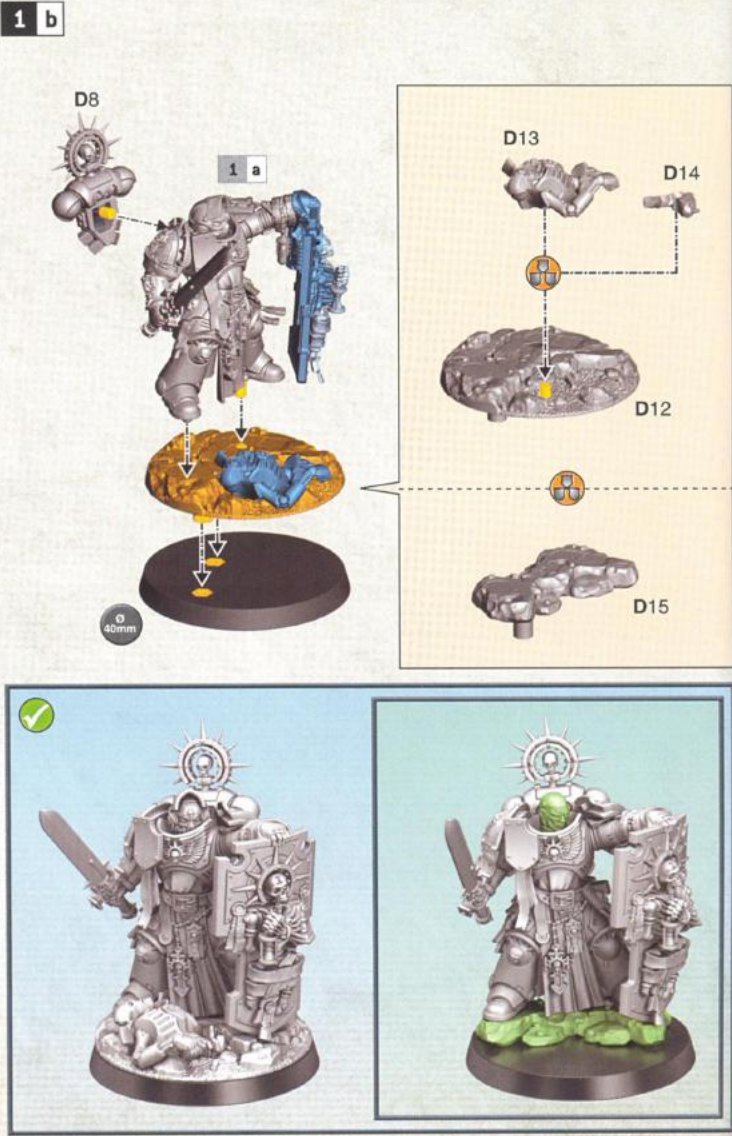

2

PRIMARIS LIEUTENANT | LIEUTENANT PRIMARIS | TENIENTE PRIMARIS | PRIMARIS-LIEUTENANT | TENENTE PRIMARIS | プライマリリス・レフテナント
基因原体副官

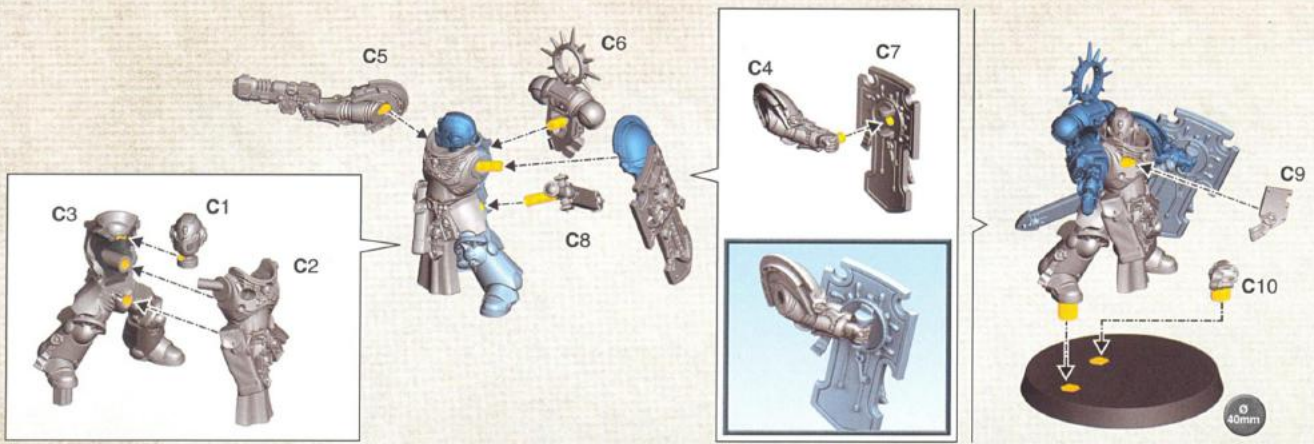

3

PRIMARIS CHAPLAIN | CHAPELAIN PRIMARIS | CAPELLÁN PRIMARIS | PRIMARIS-ORDENSPRIESTER | CAPPELLANO PRIMARIS | プライマリリス・チャブレイン
基因原体教士

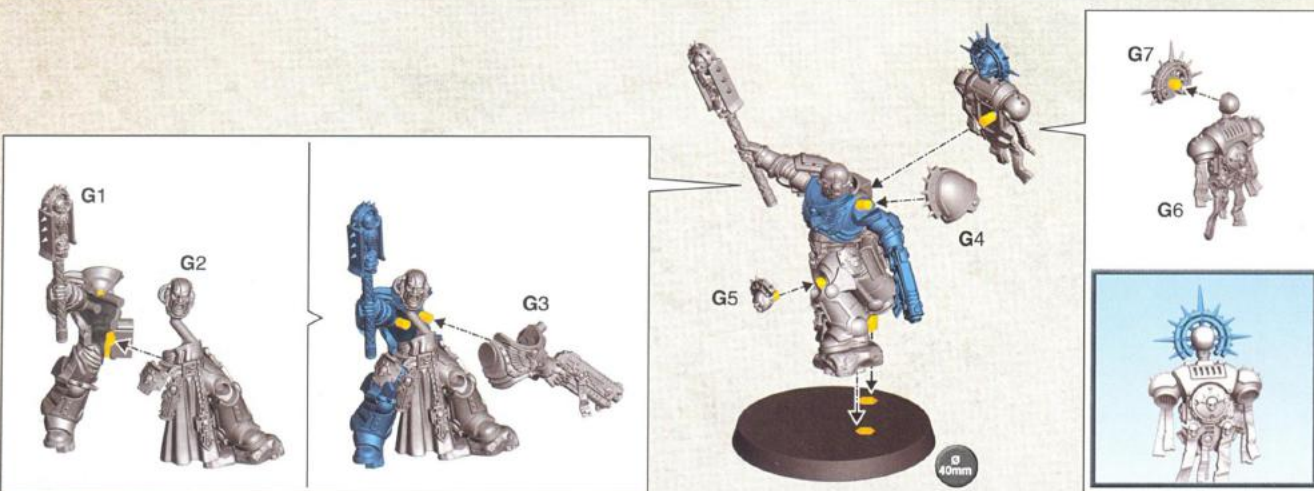

4

JUDICIAR | JUDICATEUR | JUDICIAR | JUDICAR | JUDICIAR | ジュディシア | 审判官

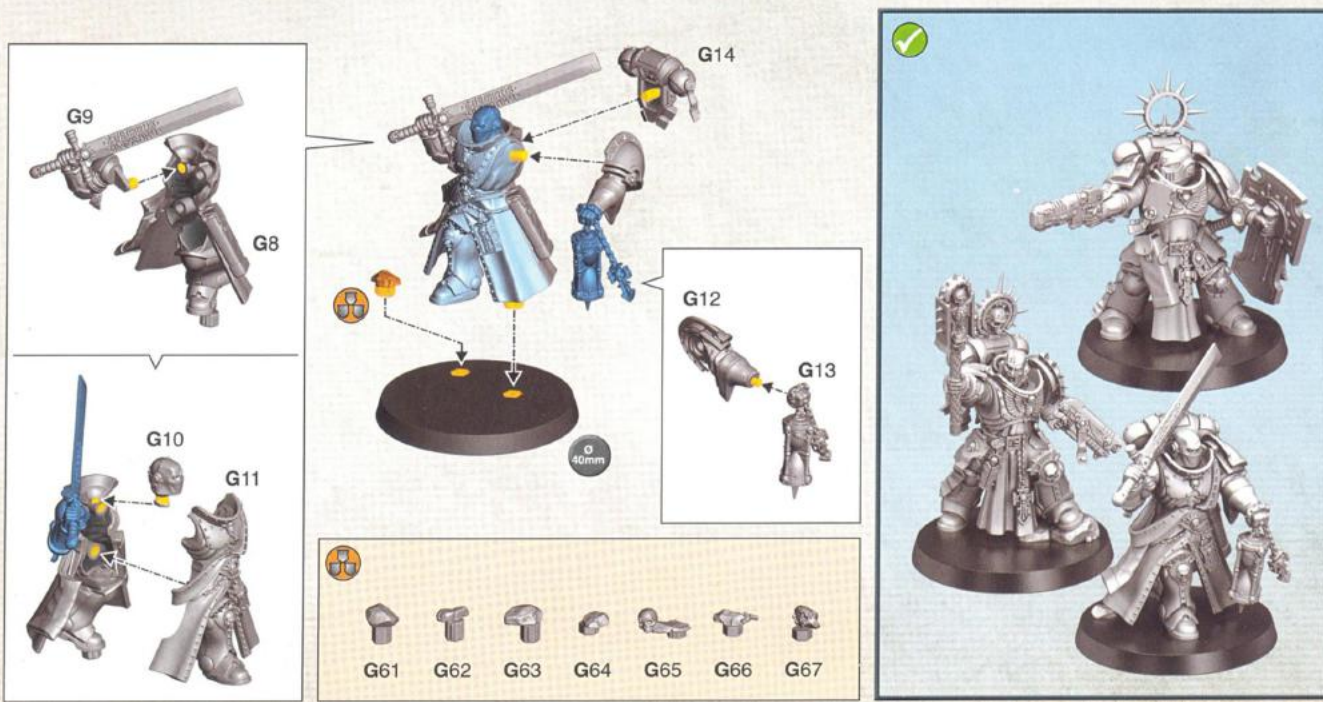

- 
G61
- 
G62
- 
G63
- 
G64
- 
G65
- 
G66
- 
G67

5 a

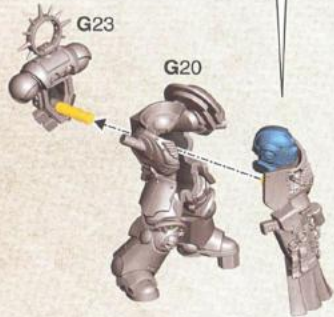

5 b



5 c

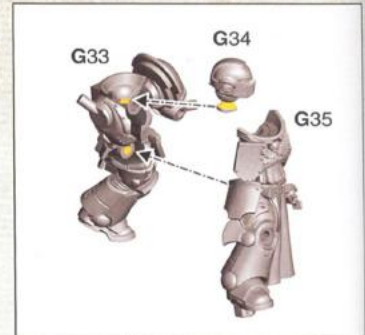

6

BLADEGUARD ANCIENT | DOYEN BLADEGUARD | GUARDAHOJA ANCIANO | KLINGENWACHT-STANDARTENTRÄGER | ANTICO GUARDIA DELLA LAMA
レイドガード・エインゼント | 剣卫旗手

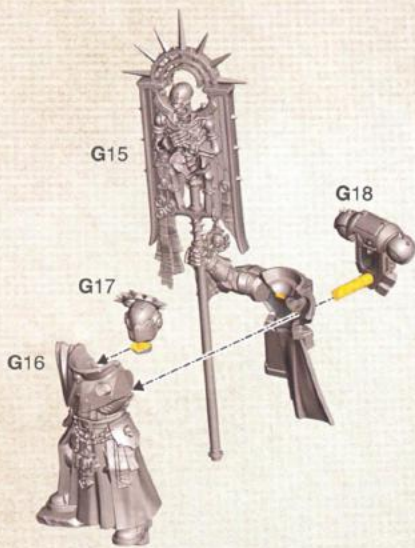

7

ASSAULT INTERCESSOR SQUAD | ESCOUADE D'ASSAUT INTERCESSOR | ESCUADRA INTERCESORES DE ASALTO | INTERCESSOR-STURMTRUPP
SQUADRA INTERCESSOR D'ASSALTO | アサルト・インターセッサ・スカッド | 突击仲裁者小队

7 a

Assault Intercessor Sergeant | Sergent Intercessor d'Assaut | Sargento Intercesor de Asalto | Sturm-Intercessor-Sergeant | Intercessor d'Assalto Sergente
アサルト・インターセッサ・サージェント | 仲裁者突击军士

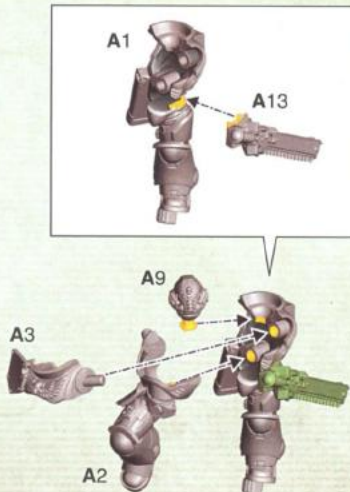
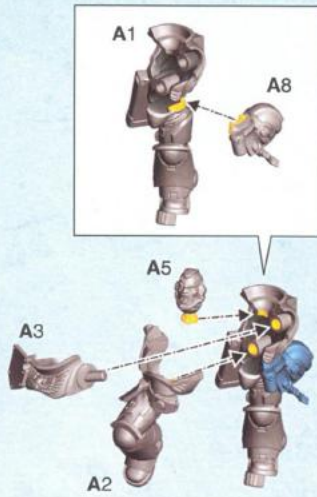

7 b

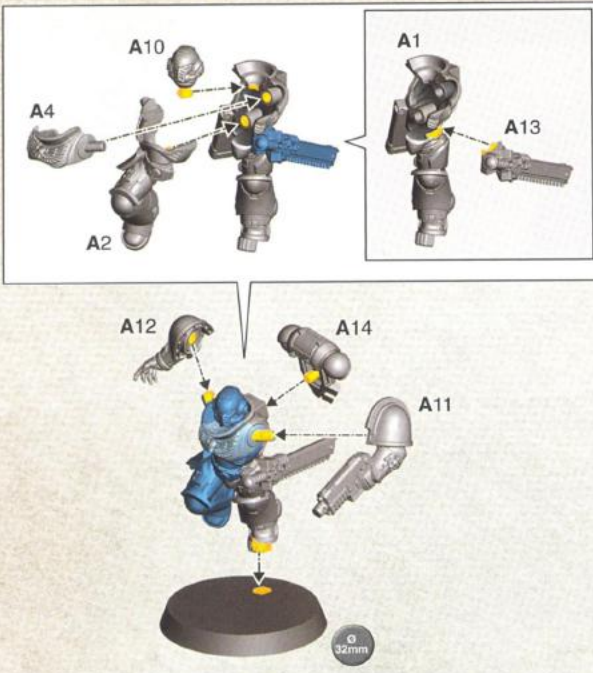

7 c x2

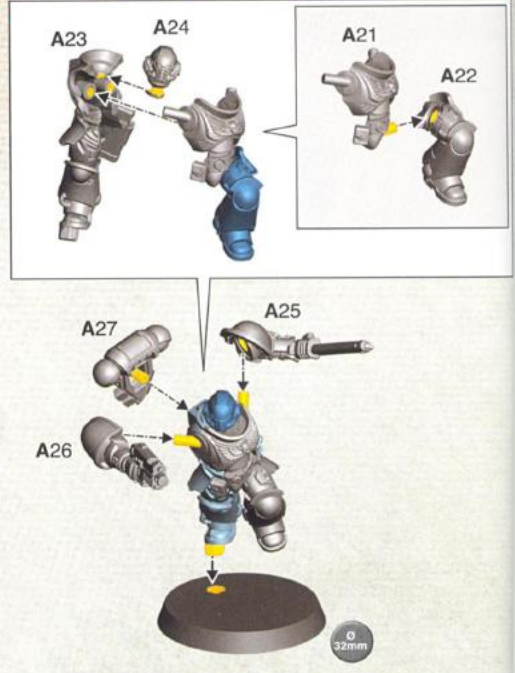

7 d x2

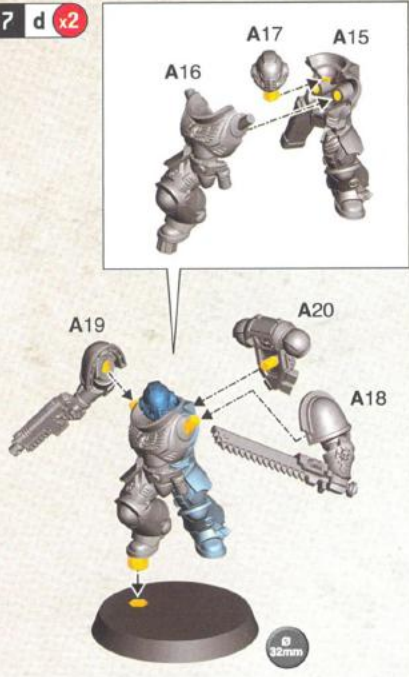

7 e x2

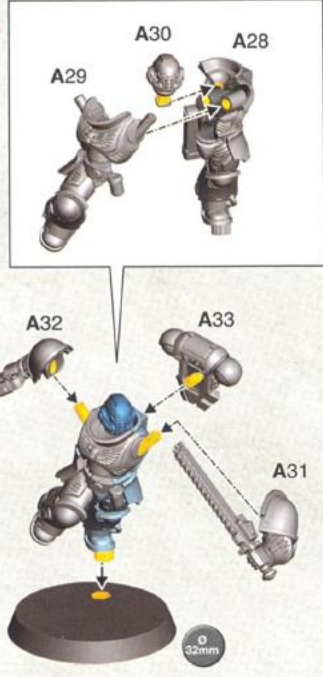

7 f x2

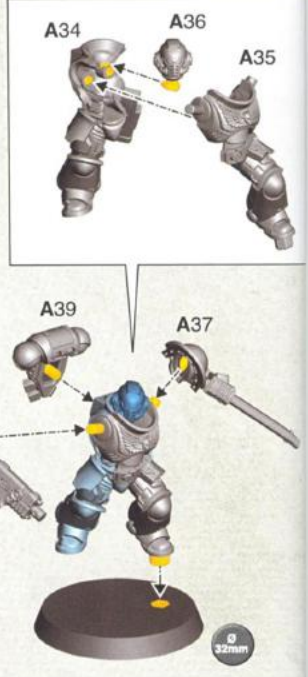

8 a.1

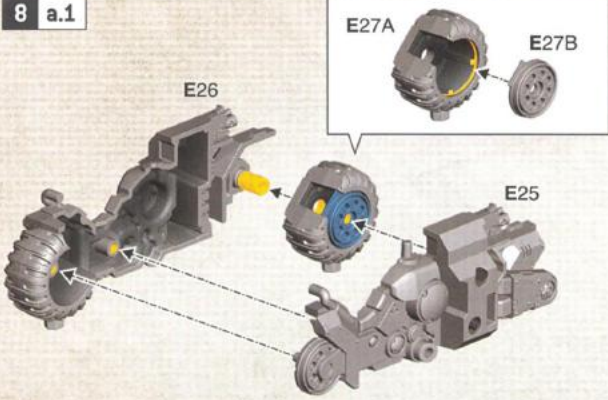

8 a.2

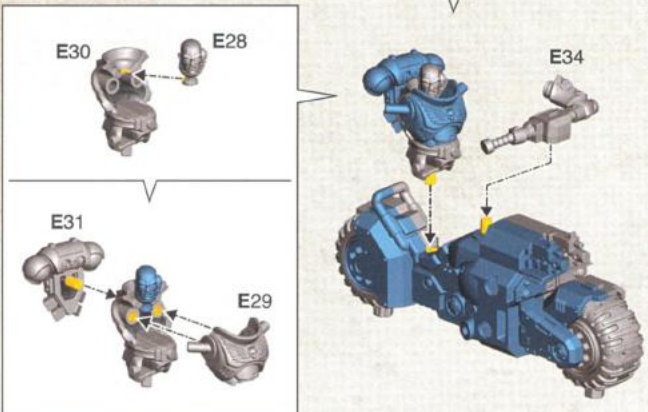
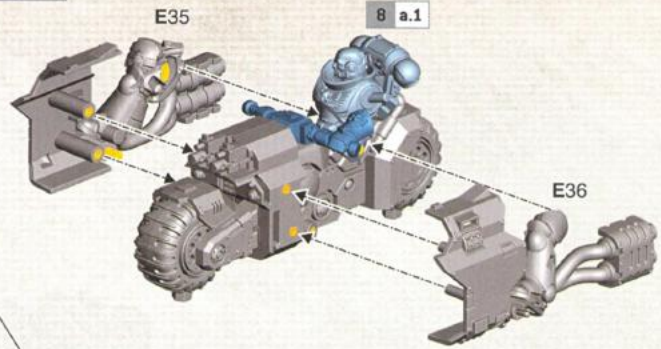

8 b.1

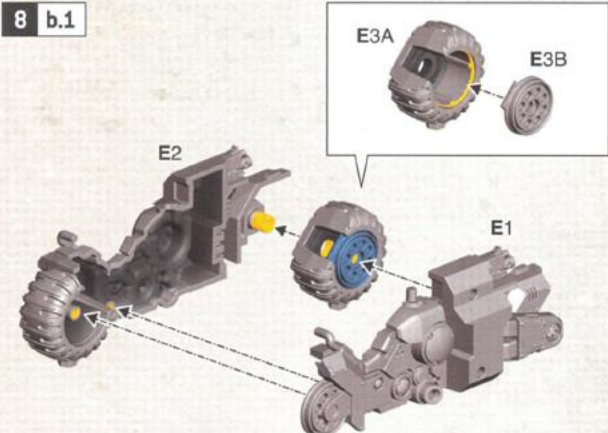

8 b.2

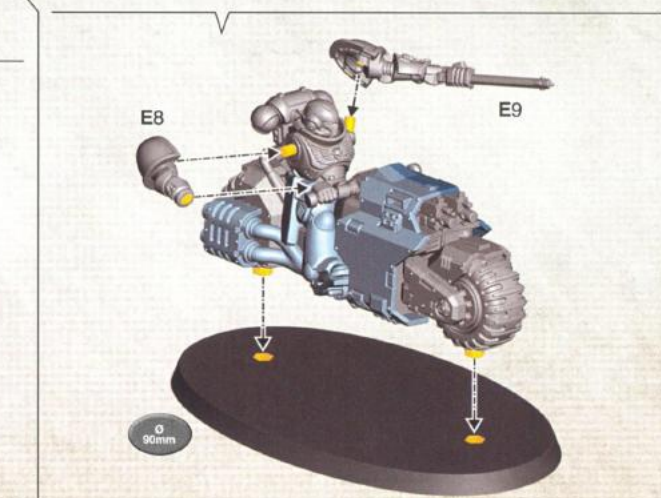
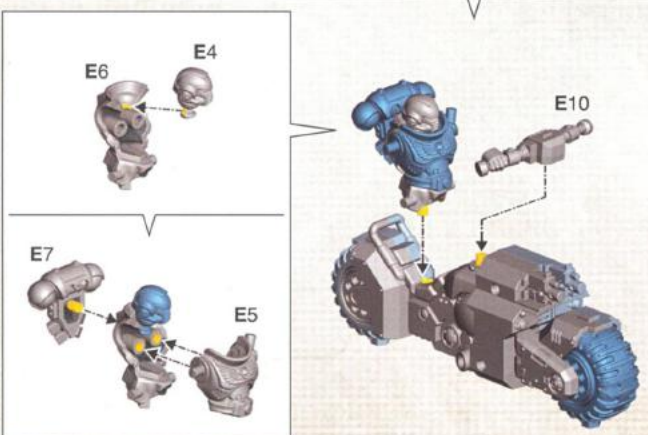
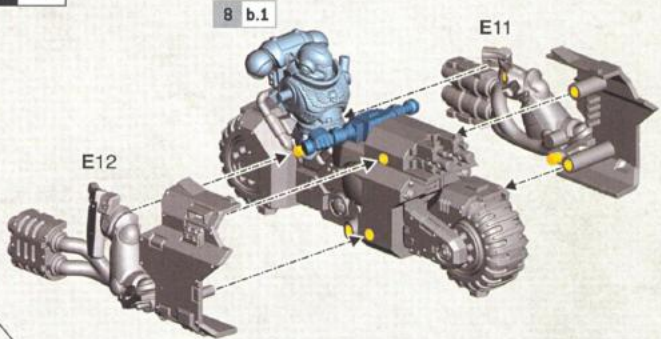

8 c.1

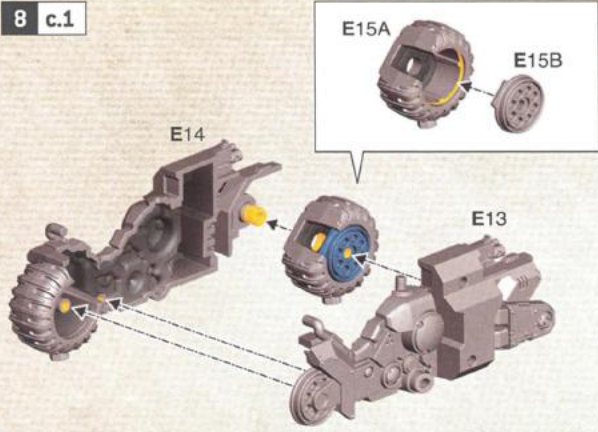

8 c.2

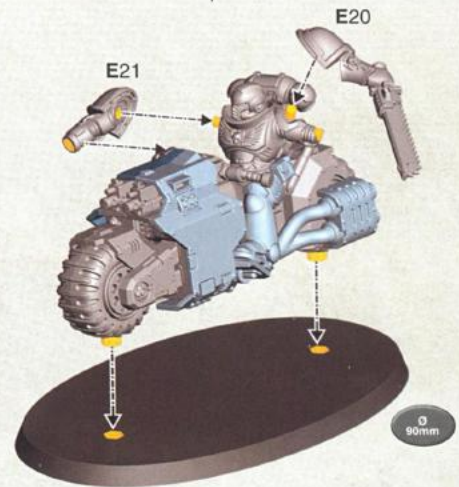
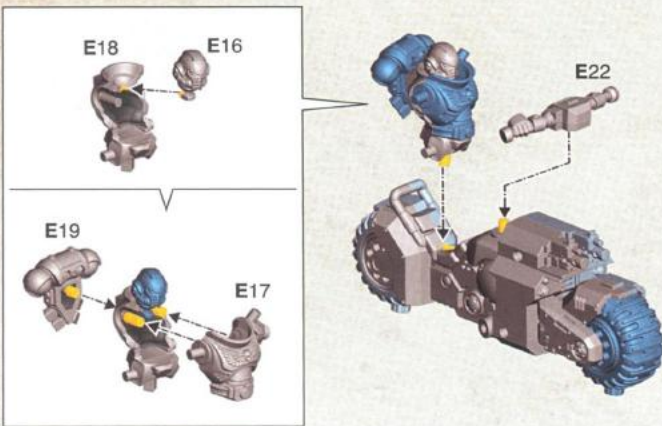
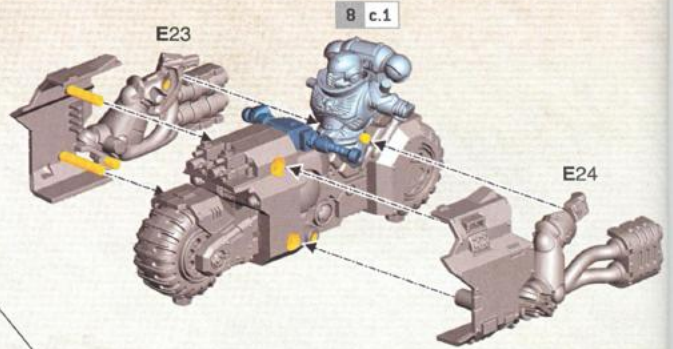

Part	Quantity	Color
1	1	Blue
2	1	Blue
3	1	Blue
4	1	Blue
5	1	Blue
6	1	Blue
7	1	Blue
8	1	Blue
9	1	Blue
10	1	Blue
11	1	Blue
12	1	Blue
13	1	Blue
14	1	Blue
15	1	Blue
16	1	Blue
17	1	Blue
18	1	Blue
19	1	Blue
20	1	Blue
21	1	Blue
22	1	Blue
23	1	Blue
24	1	Blue
25	1	Blue
26	1	Blue
27	1	Blue
28	1	Blue
29	1	Blue
30	1	Blue
31	1	Blue
32	1	Blue
33	1	Blue
34	1	Blue
35	1	Blue
36	1	Blue
37	1	Blue
38	1	Blue
39	1	Blue
40	1	Blue
41	1	Blue
42	1	Blue
43	1	Blue
44	1	Blue
45	1	Blue
46	1	Blue
47	1	Blue
48	1	Blue
49	1	Blue
50	1	Blue
51	1	Blue
52	1	Blue
53	1	Blue
54	1	Blue
55	1	Blue
56	1	Blue
57	1	Blue
58	1	Blue
59	1	Blue
60	1	Blue
61	1	Blue
62	1	Blue
63	1	Blue
64	1	Blue
65	1	Blue
66	1	Blue
67	1	Blue
68	1	Blue
69	1	Blue
70	1	Blue
71	1	Blue
72	1	Blue
73	1	Blue
74	1	Blue
75	1	Blue
76	1	Blue
77	1	Blue
78	1	Blue
79	1	Blue
80	1	Blue
81	1	Blue
82	1	Blue
83	1	Blue
84	1	Blue
85	1	Blue
86	1	Blue
87	1	Blue
88	1	Blue
89	1	Blue
90	1	Blue
91	1	Blue
92	1	Blue
93	1	Blue
94	1	Blue
95	1	Blue
96	1	Blue
97	1	Blue
98	1	Blue
99	1	Blue
100	1	Blue



9 a

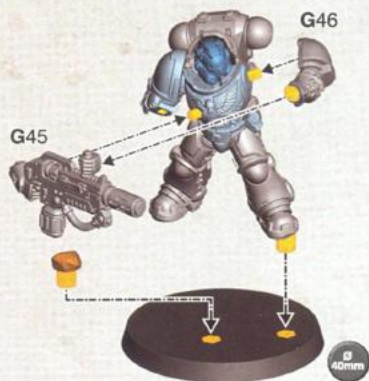
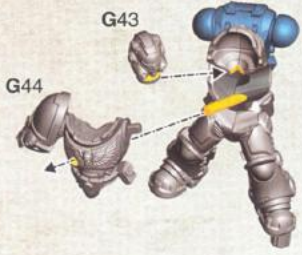
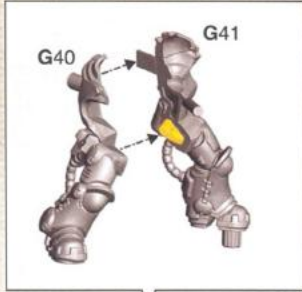

9 b

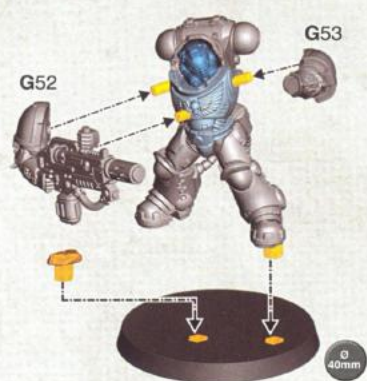
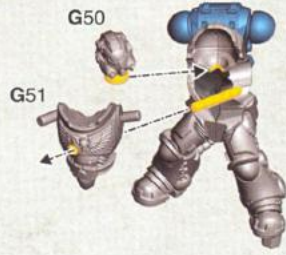

9 c

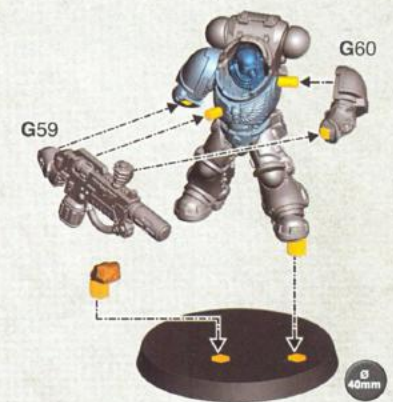
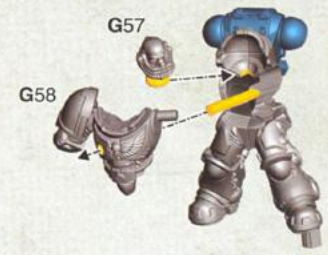
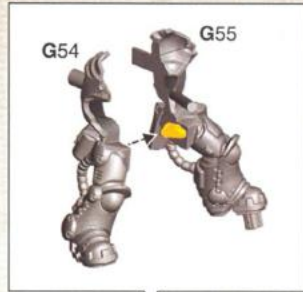

10 a

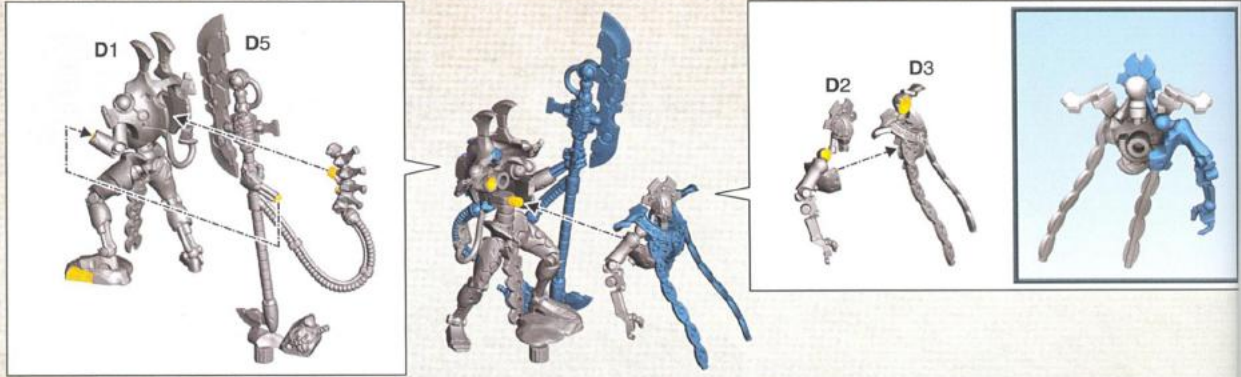

10 b

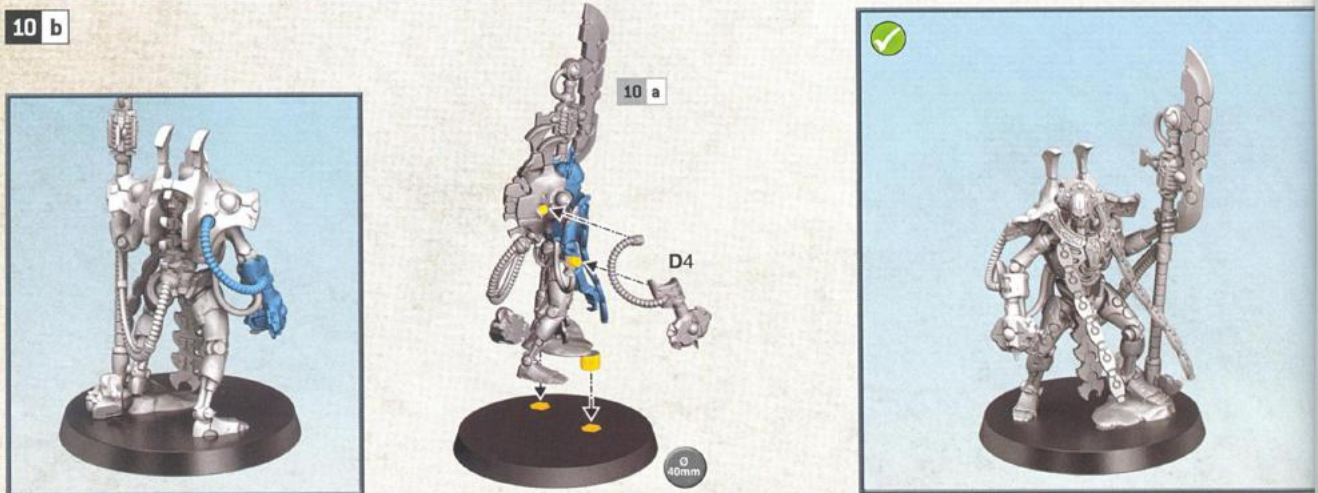

11 a

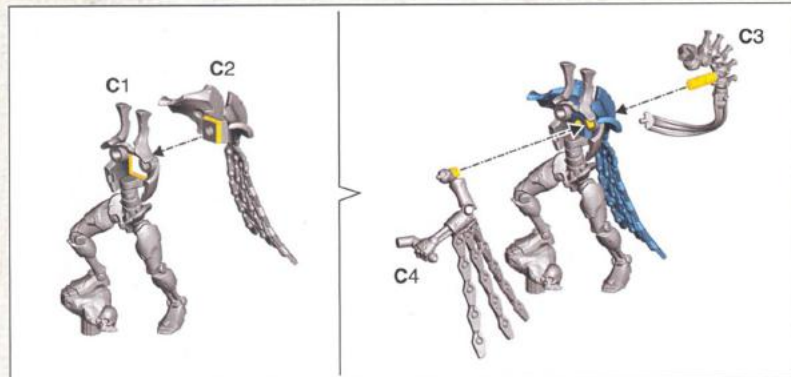

11 b

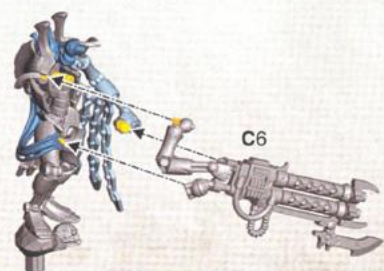
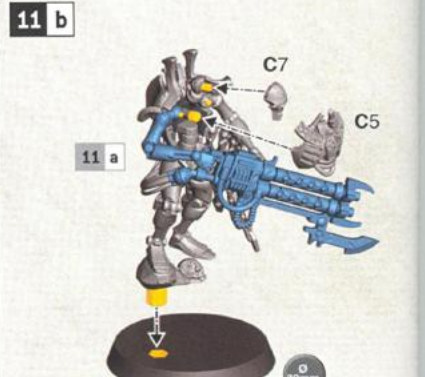

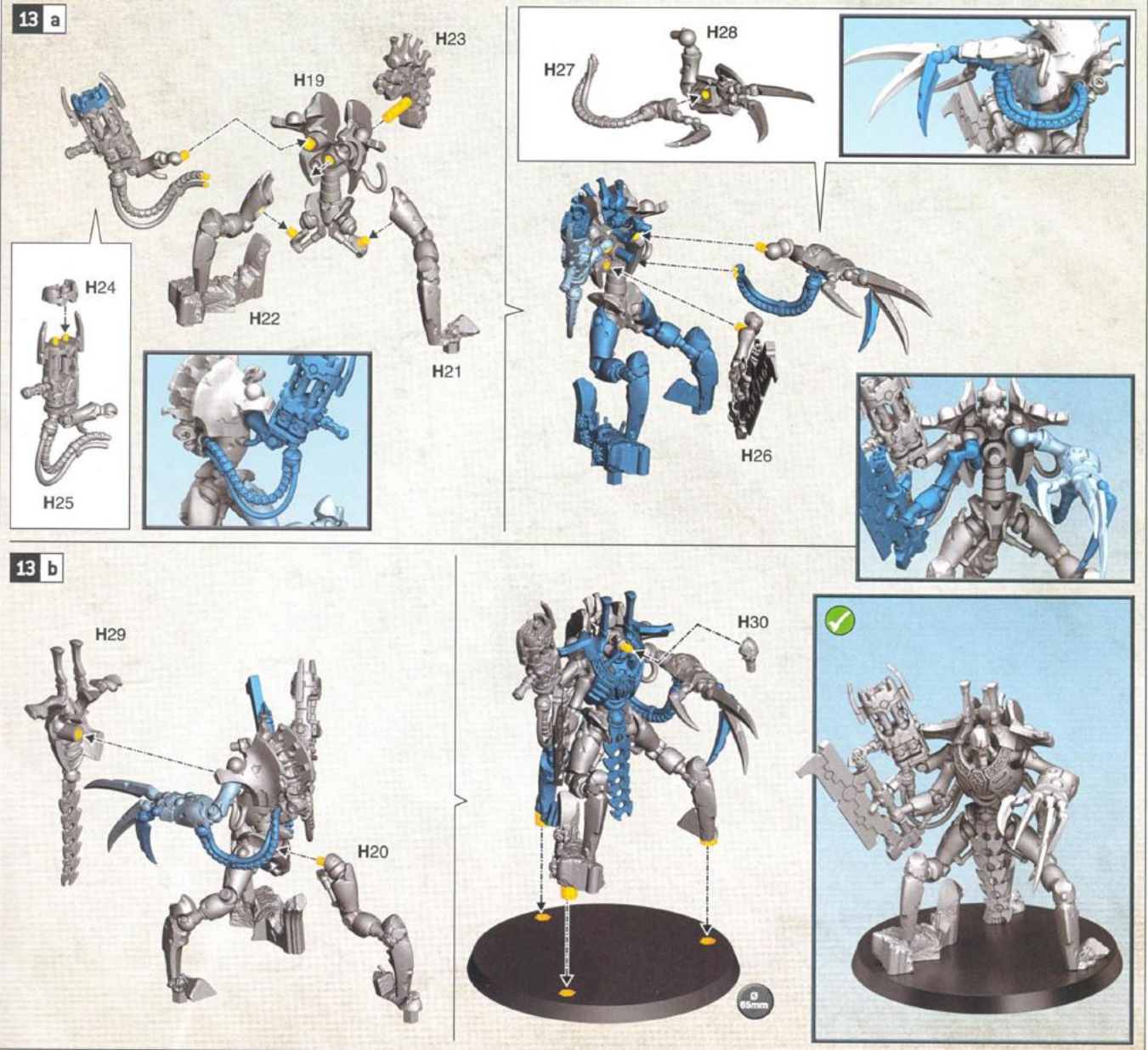
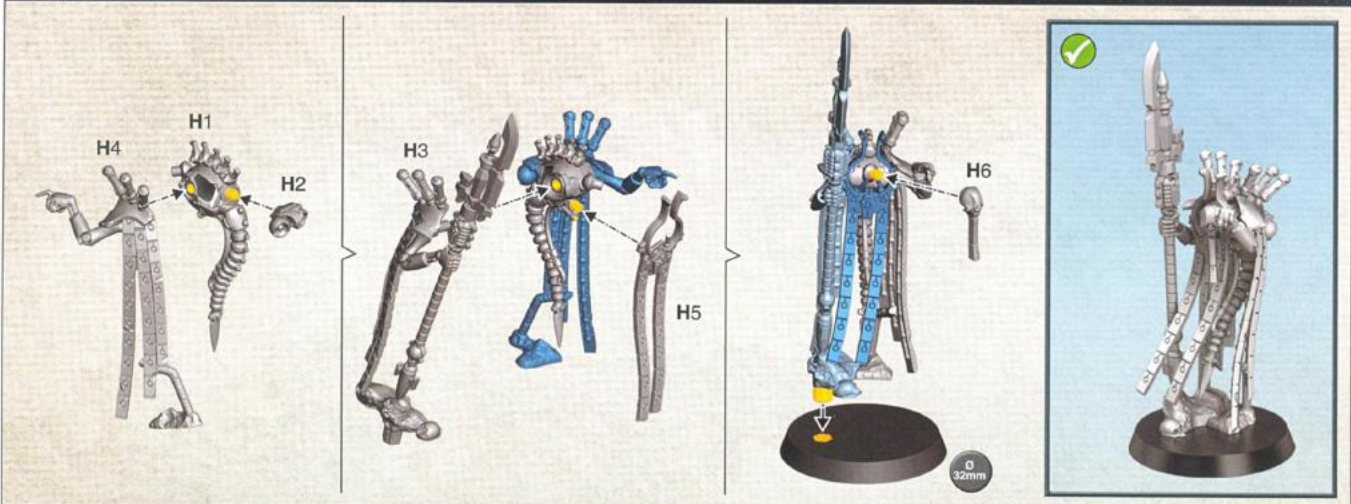

14 a.1

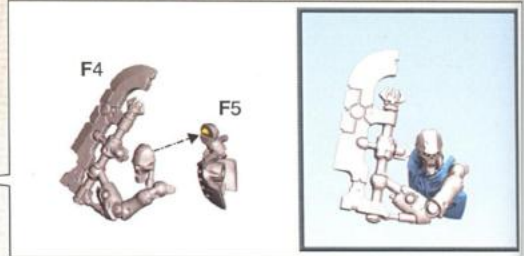
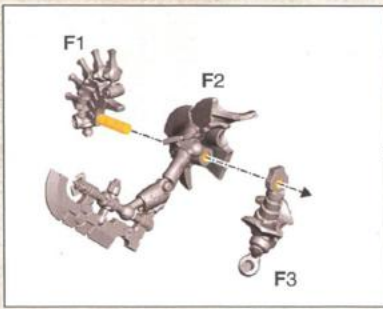

14 a.2

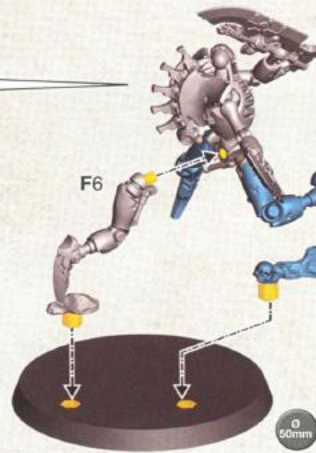
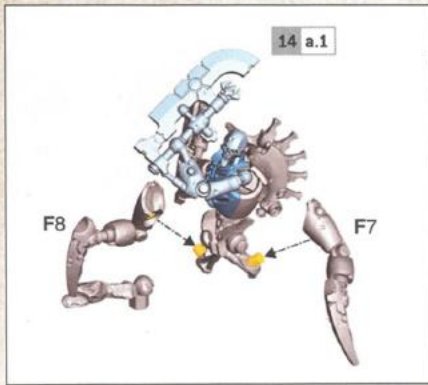

14 b.1

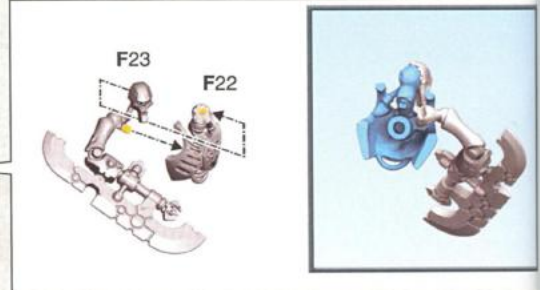
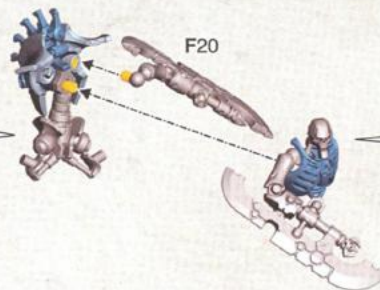
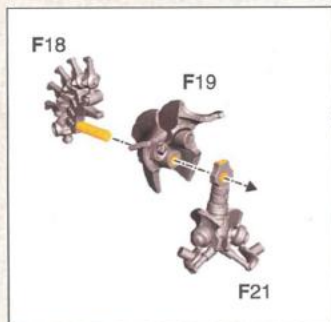

14 b.2

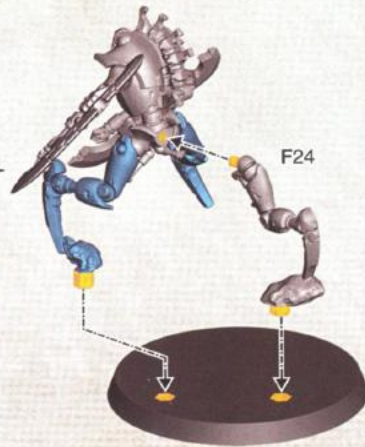
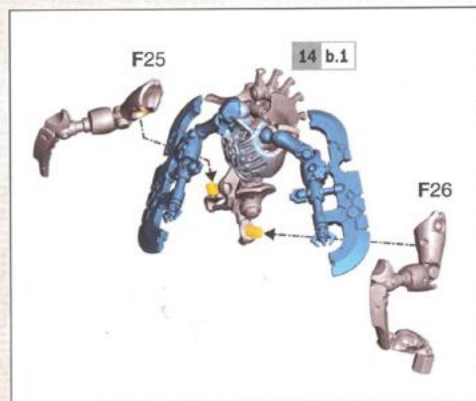

14 c.1

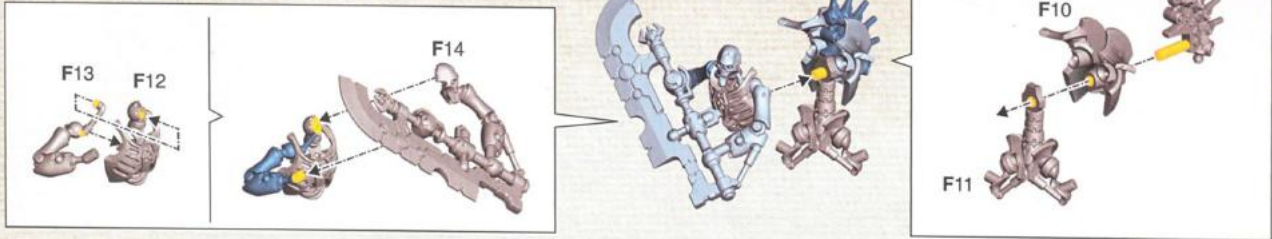

14 c.2

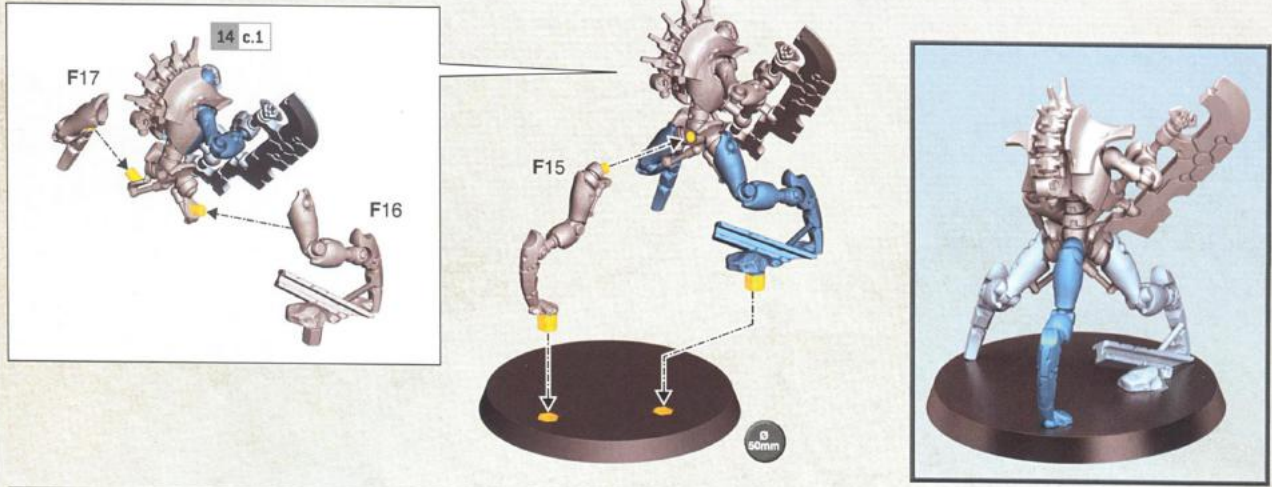

14 d



15

CRYPTOTHALLS | CRYPTOSEKRS
CRIFTOSIERVOS | KRYPTOKNECHTE
CRYPTOSCHIAVI | クリプトスロール
神秘奴

15 a

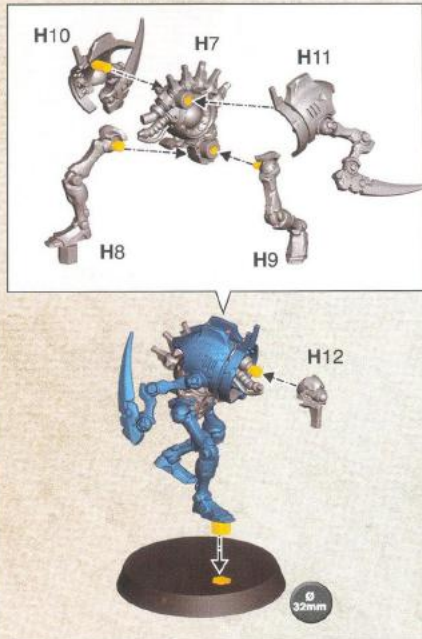

15 b

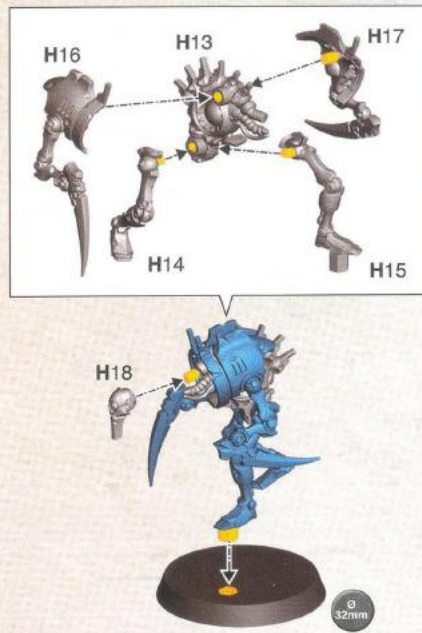

16

CANOPEK REANIMATOR | RÉANIMATEUR CANOPEK | REANIMADOR CANÓPTICO | KANOPEK-REANIMATOR
RIANIMATORE CANOPEK | カノペック・リアニメーター | 墓穴重生者

16 a

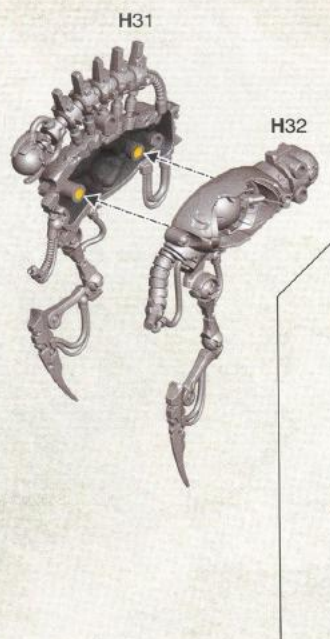

16 b

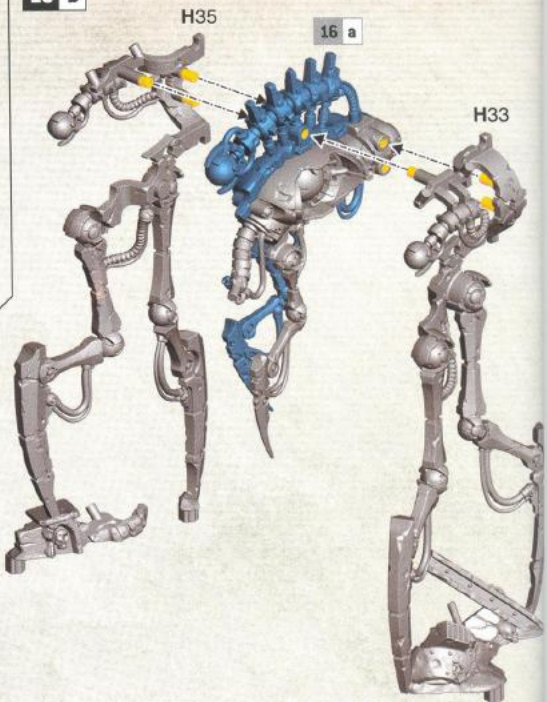

16 c

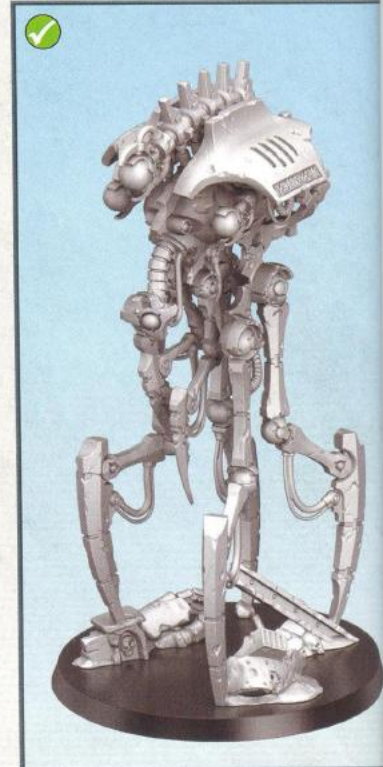
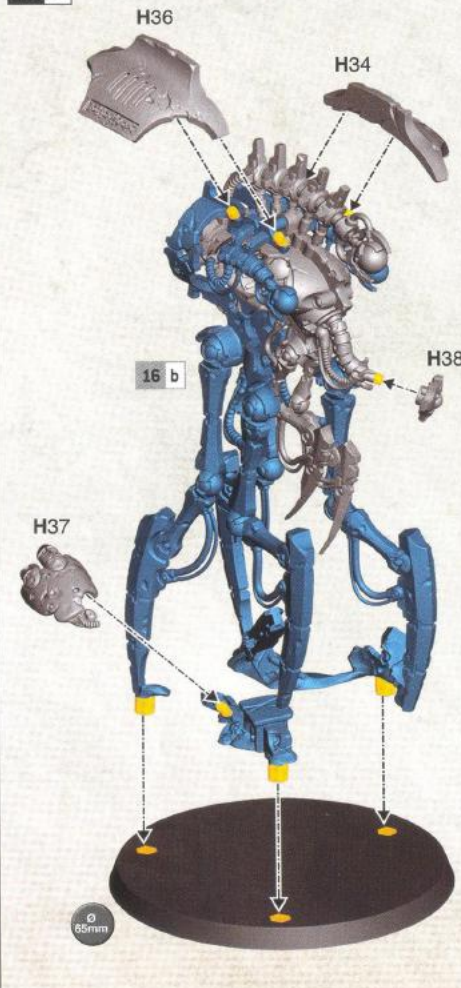



- Gauss flayer
- Écorcheur Gauss
- Rifle gauss
- Gauss-Desintegrator
- Scorticatore gauss
- ガウスフレイヤー
- 高斯撕裂枪



- Gauss reaper
- Faucheur Gauss
- Segador gauss
- Gauss-Schnitter
- Scorticatore gauss
- ガウスリーパー
- 高斯收割枪

17 a x2

B2

B3A

B3B

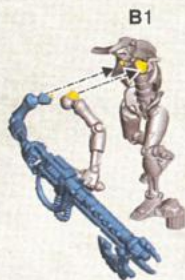

B4 B4A

B5

17 b x2

B7

B8A

B8B

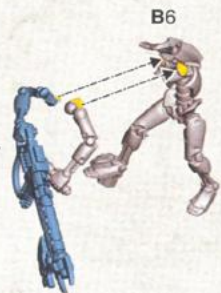

B9 B9A

B10

17 c x2

B12

B13A

B13B

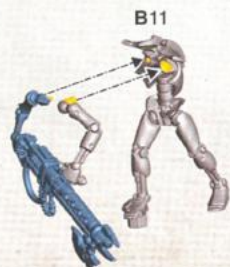

B14 B14A

B15

17 d x2

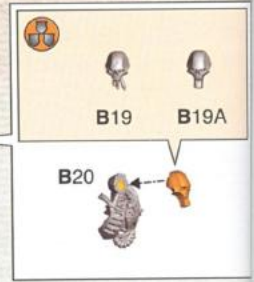
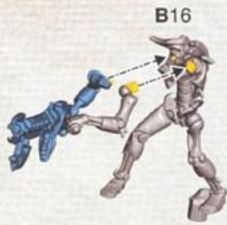
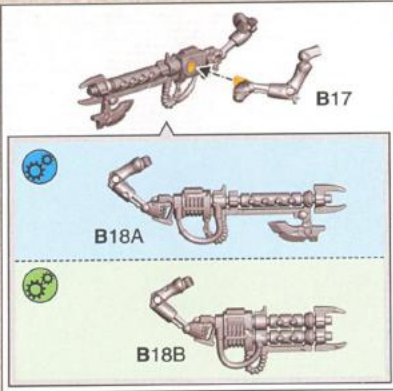

17 e x2

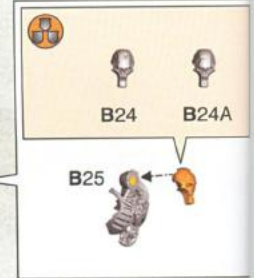
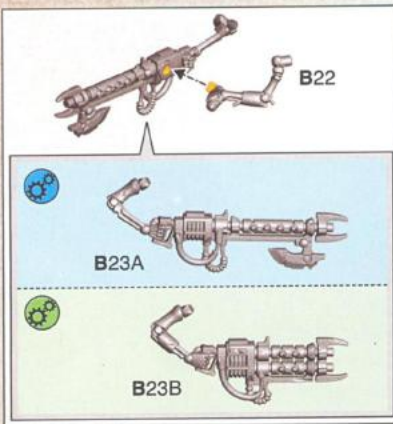

17 f x2

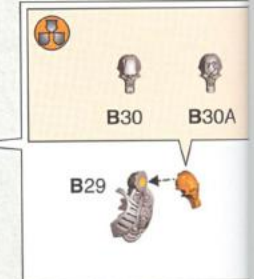
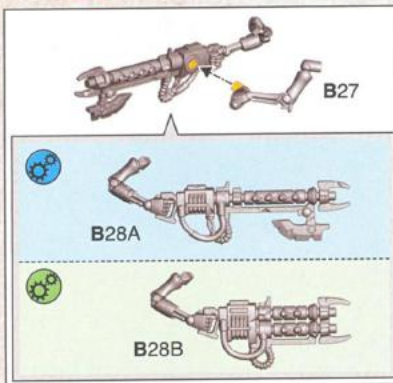

17 g x2

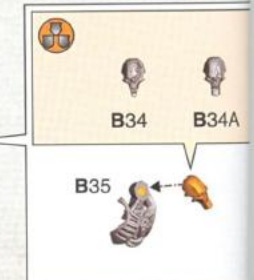
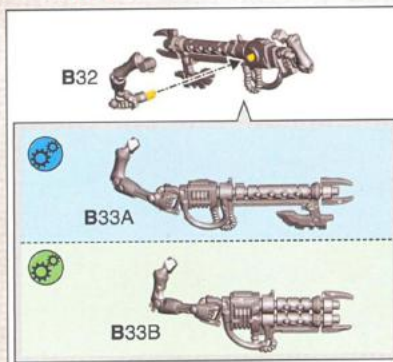

17 h x2

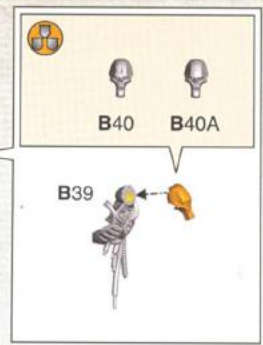
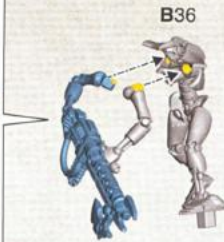
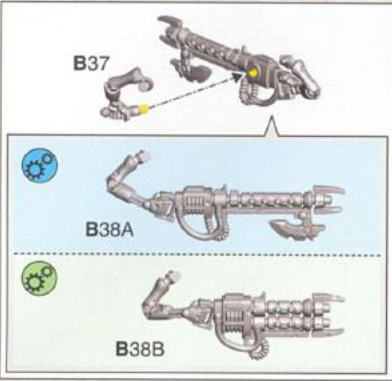

17 i x2

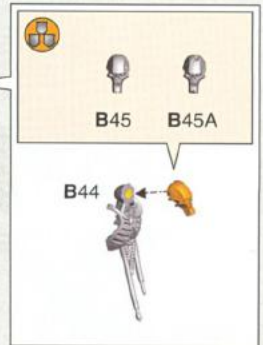
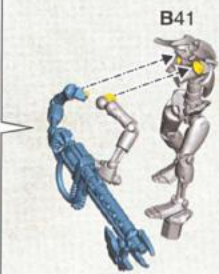
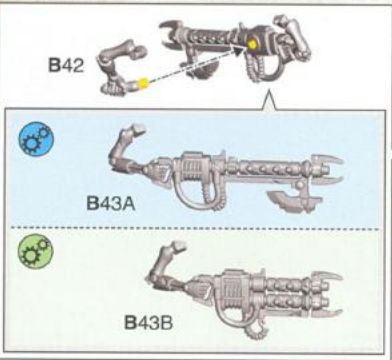

17 j x2

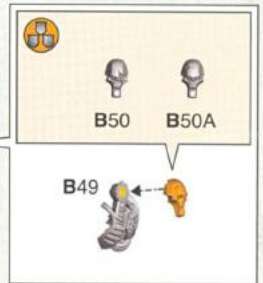
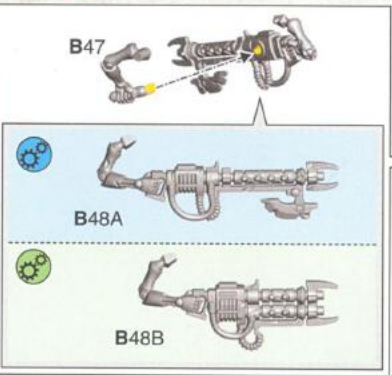

x2

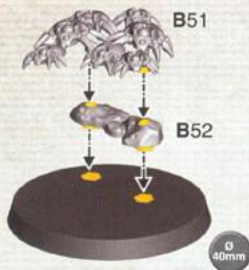

x2

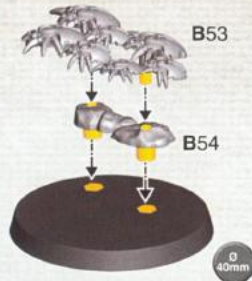

x2



ENG For the full painting guide, please visit citadelcolour.com/guides
FRE Le guide de peinture complet est disponible sur citadelcolour.com/guides
ESP Puedes encontrar la guía completa de pintura en citadelcolour.com/guides
GER Die vollständige Bemalanleitung findest du auf citadelcolour.com/guides

ITA Puoi trovare la guida completa alla pittura su citadelcolour.com/guides
日本文 ペイントの完全版ガイドはcitadelcolour.comに掲載されている。
中文 可以在 citadelcolour.com/guides 找到完整涂装指南。

