



Free Downloads of Build Instructions,
Assembly Booklets & How To Guides

BuildInstructions.com

WARHAMMER
AGE OF SIGMAR

WARCRY™



NIGHTMARE QUEST

QUÊTE DE CAUCHEMAR • BÚSQUEDA DE PESADILLA • ALBTRAUMQUESTE • VIAGGIO DA INCUBO
КОШМАРНАЯ СХВАТКА • ナイトメア・クエスト • 噩夢征戦

READ THIS FIRST • À LIRE EN PRIORITÉ • BITTE BEACHT E • LEE ESTO PRIMERO • LEGGI PRIMA QUESTO
В ПЕРВУЮ ОЧЕРЕДЬ ПРОЧИТАЙТЕ ЭТО • 最初にお読みください。 • 请优先阅读

ENG BEFORE ASSEMBLING YOUR MINIATURES, PLEASE READ THROUGH THE INSTRUCTIONS IN THIS BOOKLET CAREFULLY. A pair of plastic cutters is required to remove the plastic components in this kit from their frame. We advise using a mouldline scraping tool to clean up the parts. To assemble your model you will need plastic glue. Games Workshop sells Citadel Fine Detail Cutters, Citadel Mouldline Remover and Citadel Plastic Glue, but does not recommend these products for use by children under the age of 16 without adult supervision.

FRE AVANT D'ASSEMBLER VOS FIGURINES, VEUILLEZ LIRE ATTENTIVEMENT LES INSTRUCTIONS DE CE LIVRET. Une pince coupante est requise pour détacher chaque élément de sa grappe. Nous vous recommandons l'utilisation d'un grattoir pour ébarber les éléments. Pour l'assemblage, vous aurez également besoin de colle plastique. Games Workshop commercialise les Pinces de Précision Citadel, l'Ébarboir Citadel et la Colle Plastique Citadel, mais n'en recommande pas l'utilisation pour des enfants de moins de 16 ans sans la supervision d'un adulte.

SPA POR FAVOR, LEE CUIDADOSAMENTE ESTE LIBRETO DE INSTRUCCIONES ANTES DE EMPEZAR A MONTAR LAS MINIATURAS. Te harán falta unas tenazas para plástico a fin de separar las piezas de la matriz. También aconsejamos una herramienta para rebabas a fin de limpiar cada pieza. Para montar la miniatura necesitarás pegamento para plástico. Games Workshop vende tenazas Citadel, Herramientas para rebabas Citadel y Pegamento para plástico Citadel, pero no recomienda estos productos a menores de 16 años sin la supervisión de un adulto.

GER VOR DEM ZUSAMMENBAU DER MINIATUREN BITTE DIE ANWEISUNGEN IN DIESER ANLEITUNG AUFMERKSAM DURCHLESEN. Du benötigst einen Kunststoffseitschneider, um die Kunststoffbauteile aus dem Gussrahmen herauszutrennen, und Kunststoffkleber, um die Miniatur zusammenzubauen. Außerdem empfehlen wir, die Bauteile vorher mit einem Gussgratentferner zu säubern. Games Workshop bietet Präzisions-Kunststoffseitschneider von Citadel sowie Citadel-Kunststoffkleber an, empfiehlt aber, dass Kinder unter 16 Jahren diese nur unter Aufsicht eines Erwachsenen benutzen.

ITA PRIMA DI ASSEMBLARE LE TUE MINIATURE LEGGI ATTENTAMENTE TUTTE LE ISTRUZIONI DI QUESTO LIBRETTO. Sono necessarie un paio di tronchesine per plastica per staccare i componenti dai loro sprue. Consigliamo di usare un attrezzo apposito per pulire i componenti. Per assemblare il modello avrai bisogno di colla per plastica. Games Workshop vende Tronchesine di precisione Citadel, Attrezzo per ripulire Citadel e Colla per plastica Citadel, ma non consiglia questi prodotti ad un pubblico minore di 16 anni senza la supervisione di un adulto.

RUS КУСАЧКИ ДЛЯ ПЛАСТИКА НУЖНЫ ДЛЯ СНЯТИЯ ПЛАСТИКОВЫХ ЭЛЕМЕНТОВ НАБОРА С РАМОК. Для зачистки деталей рекомендуем использовать инструмент для удаления дефектов. Для сборки модели вам понадобятся клеи для пластика. Компания Games Workshop предоставляет кусачки «Citadel Fine Detail Cutters», инструмент для удаления дефектов «Citadel Mouldline Remover» и клеи для пластика «Citadel Plastic Glue», но не рекомендует эти изделия к использованию детьми младше 16 лет без надзора взрослых.

CHN 本キット内のフレームからプラスチックパーツを切り離すためには、ニッパーが必要です。パーツのモールドを平らにするには、専用ツールの使用をお勧めいたします。本キットの組み立てには、プラ用接着剤が必要です。ゲームズワークショップはシタデル・ニッパー、プラ用接着剤、シタデル・モールドラインリムーバーを販売しておりますが、16歳以下の子供が大人の監督なしにこれらの道具を使用されることをお勧めしません。

CHN 你需要一把模型剪将塑料部件从板件上剪下来。我们建议使用分模线刮刀来处理零件。组装时你还需要用到模型胶水。你可以从 Games Workshop 处购买到 Citadel Fine Detail Cutter 模型剪、Citadel Mouldline Remover 分模线刮刀和 Citadel Plastic Glue 模型胶。但 16 岁以下儿童不得在没有成年人监护的情况下使用这些产品。

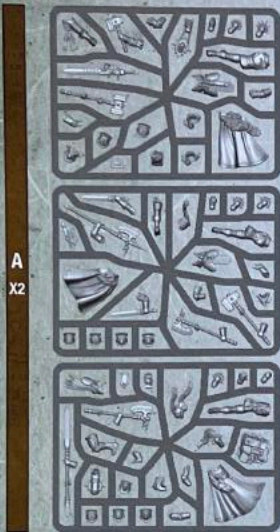

A
x2

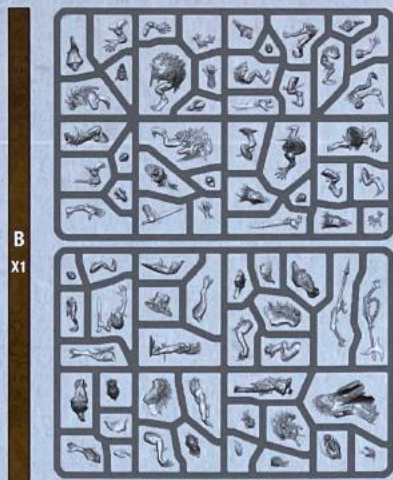

B
x1

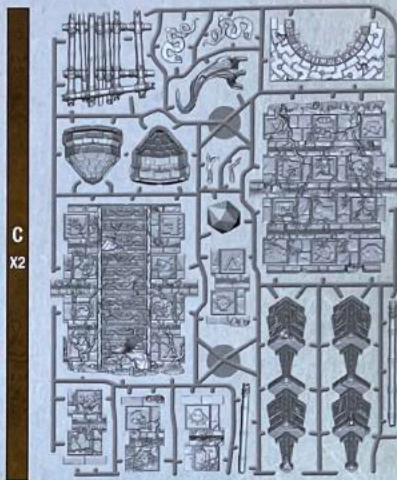

C
x2

- Ø 46mm x8
- Ø 32mm x2
- Ø 28mm x3
- Ø 25mm x3

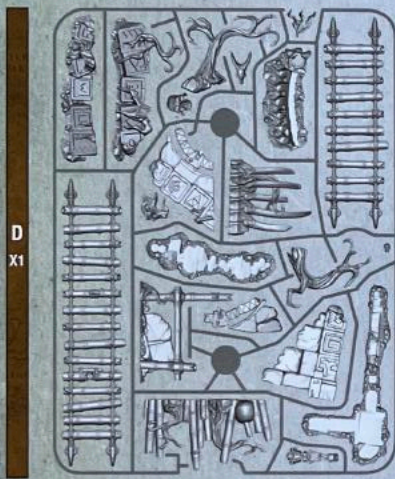

D
x1



E
x1

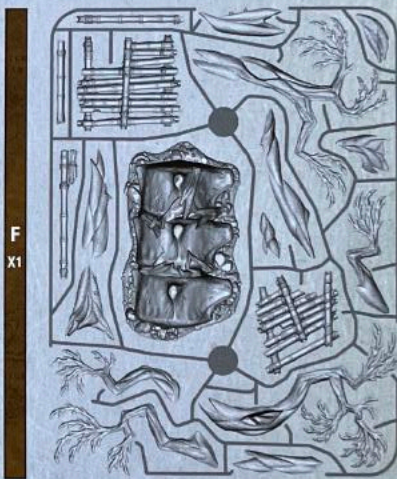

F
x1

**USE CORRECT BASES • UTILISEZ LES SOCLES APPROPRIÉS • USA LAS PEANAS CORRECTAS
BASEGRÖSSEN BEACHTEN • USA LE BASETTE CORRETTE
ИСПОЛЬЗУЙТЕ ПОДХОДЯЩИЕ ПОДСТАВКИ • 適切なベースサイズ • 使用正确的底座**

- Your models are supplied with different-sized bases. Use the diagram on the right to help you to determine which is the correct base for the model you are building.
- Vos figurines sont fournies avec des socles de tailles variées. Utilisez le diagramme ci-contre pour vous aider à déterminer quel est le socle adapté à la figurine que vous assemblez.
- Tus miniaturas se suministran con peanas de diferentes tamaños. Usa el diagrama a la derecha para ayudarte a determinar cuál es la peana correcta para la miniatura que estás montando.
- Für jede Miniatur ist eine bestimmte Basegröße vorgesehen. Mit dem Diagramm rechts kannst du bestimmen, welches Base zu dem Modell gehört, das du gerade zusammenbaust.

- I tuoi modelli sono forniti con basette di dimensioni differenti. Usa l'immagine a destra per aiutarti a determinare qual è la bassetta corretta per il modello che stai assemblando.
- Ваши модели поставляются с подставками разных размеров. Схема справа поможет вам выбрать подставку, подходящую для модели, которую вы собираете.
- ミニチュアにはそれぞれ異なる大きさのベースが付属している。右の図を参考に、組み立て中のミニチュアに対応した適切なベースを使用すること。
- 我们为模型提供了不同尺寸的底座。请使用右侧的图示协助您判断哪种尺寸的底座适合您正在组装的模型。

1:1

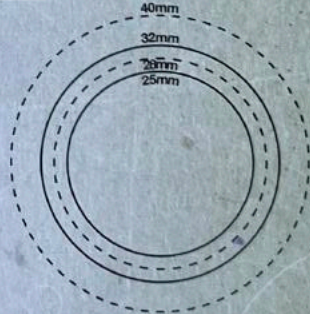

**EXPLANATION OF SYMBOLS • EXPLICATION DES SYMBOLES • EXPLICACIÓN DE SÍMBOLOS • ERLÄUTERUNG DER SYMBOLE
LEGENDA DEI SIMBOLI • РАСШИФРОВКА СИМВОЛОВ • アイコン解説 • 符号说明**

- | | | | |
|---|---|--|--|
| <ul style="list-style-type: none"> ! Special instruction - Take care • Instruction spéciale - Faites attention • Instrucciones especiales - Presta atención • Besondere Anweisung - bitte beachten • Istruzioni speciali: prestare attenzione • Особая инструкция - Будьте осторожны • 特記事項 - 要注意 • 特别说明 - 小心 | <ul style="list-style-type: none"> 🖌️ Paint before assembly • Peindre avant assemblage • Pintar antes del montaje • Erst bemalen, dann zusammenbauen • Dipinti prima dell'assemblaggio • Покрасьте перед сборкой • 組み立て前にペイントすること • 組裝前塗裝 | <ul style="list-style-type: none"> ⚙️ Variant assembly • Variante d'assemblage • Variante de montage • Bauvariante • Assemblaggio alternativo • Варианты сборки • 組み立てバリエーション • 多种组裝方式 | <ul style="list-style-type: none"> 📦 Choice of parts • Choix d'éléments • Modelos de componentes • Auswahl an Teilen • Scelta di componenti • Выбор деталей • 零件的选择 • 选择部件 |
| <ul style="list-style-type: none"> 🔍 Dry fit stage before gluing • Tester avant de coller • Comprobar el encaje antes de pegar • Positionierung erst ohne Klebstoff ausprobieren • Prova a secco prima di incollare • Этап предварительной сборки перед склеиванием • 接着前にぴったり合わせること • 粘接前的假組阶段 | <ul style="list-style-type: none"> x2 Repeat process • Répéter l'étape • Repetir pasos • Vorgang wiederholen • Ripeti il processo • Повторите действие • 同じ作業を繰り返すこと • 重复步骤 | <ul style="list-style-type: none"> ✅ Stage complete • Étape terminée • Paso completado • Schritt abgeschlossen • Fase completa • Этап завершен • このステージの完成 • 完成 | |



• Choose the variant you want to build
 • Choisissez la variante à assembler
 • Elige qué versión quieres montar

• Wähle die Variante, die du bauen möchtest
 • Scegli la variante che vuoi assemblare

• Выберите тот вариант, который хотите собрать

• 組み立てバリエーションの選択
 • 选择你喜欢的拼装方式

1 a



• Soulsworn Knight-Relictor • Chevalier-Relictor Féame
 • Caballero Relictor Almaligado • Ritter Relictor
 • Cavaliere-Relictor Anima Giurata
 • душеклятвоный рыцарь-реликтор
 • ソウルスウォーン・ナイトレリクター • 魂誓圣骸騎士

1 c



• Errant-Questor with Grandblade
 • Questor Errant avec Grande Épée
 • Hidalgo Errante con Gran Espada
 • Fahrender Questor mit Großschwert
 • Questor-Errante con lama superba
 • странствующий квестор с великим клинком
 • エラント・クエスター(大剣装備) • 装备巨刃的游侠巡遊者

1 b

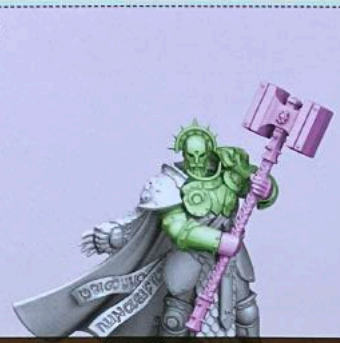

• Errant-Questor with Grandhammer
 • Questor Errant avec Grand Marteau
 • Hidalgo Errante con Gran Martillo
 • Fahrender Questor mit Großhammer
 • Questor-Errante con granmartello
 • странствующий квестор с великим молотом
 • エラント・クエスター(大錘装備) • 装备巨錘的游侠巡遊者

1 a

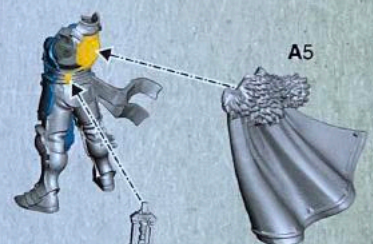
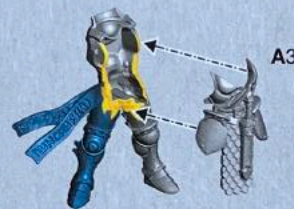
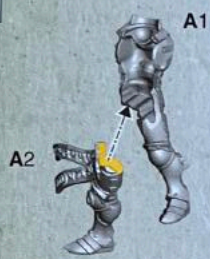

1 b

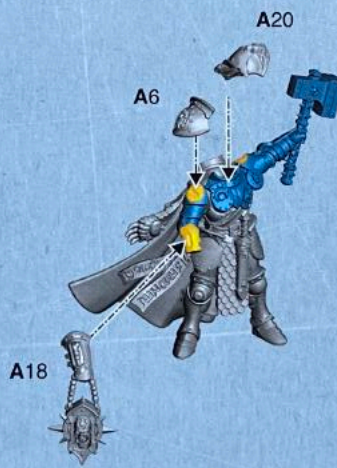

1 c

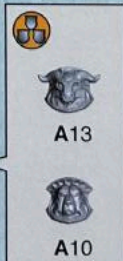
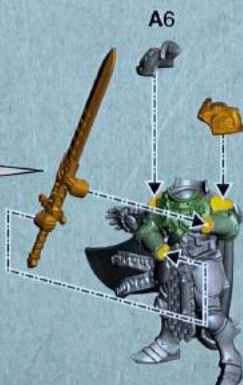
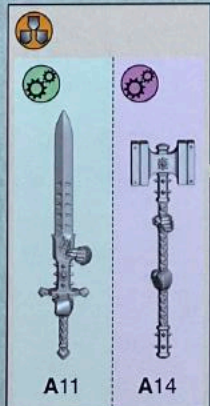
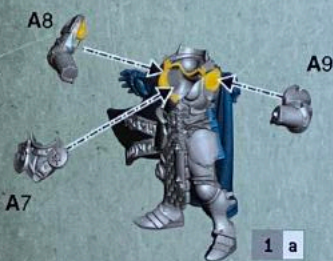



- Choose the variant you want to build
- Choisissez la variante à assembler
- Elige qué versión quieres montar

- Wähle die Variante, die du bauen möchtest
- Scegli la variante che vuoi assemblare
- Выберите тот вариант, который хотите собрать

- 組み立てバリエーションの選択
- 选择你喜欢的拼装方式

2 b



- Questor-Prime • Questor-Primus • Hidalgo Mayor
- Erster Questor • Questor-Primus • квестор-прайм
- クエストープライム • 巡遊者精兵

2 c



- Errant-Questor with Grandaxe
- Questor Errant avec Grande Hache
- Hidalgo Errante con Gran Hacha
- Fahrender Questor mit Großaxt
- Questor-Errante con grande ascia
- странствующий квестор с великим топором
- エラント・クвестー(大斧装備) • 装备巨斧的游侠巡遊者

2 d



- Errant-Questor with Grandspear
- Questor Errant avec Grande Lance
- Hidalgo Errante con Gran Lanza
- Fahrender Questor mit Großspeer
- Questor-Errante con lancia superba
- странствующий квестор с великим копьём
- エラント・クвестー(大槍装備) • 装备巨矛的游侠巡遊者

2 a

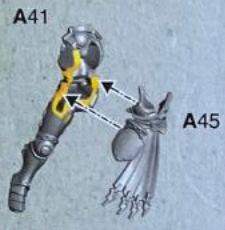

2 b

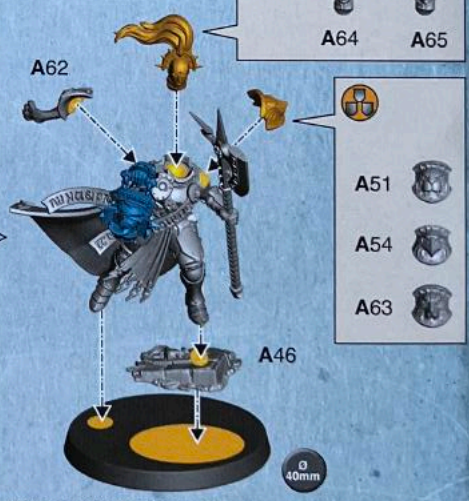
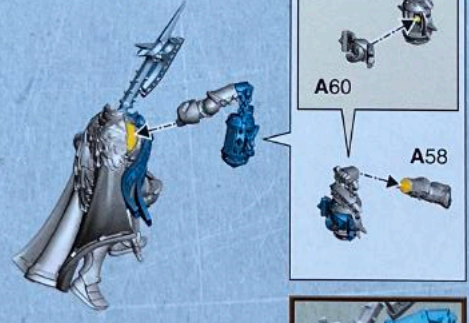

2 c

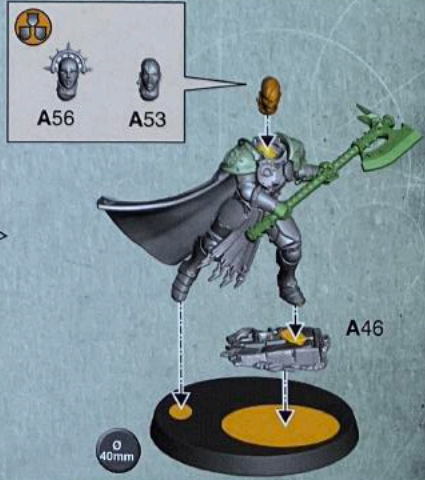
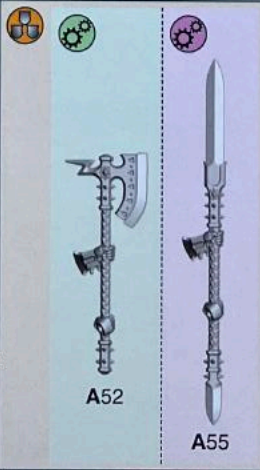
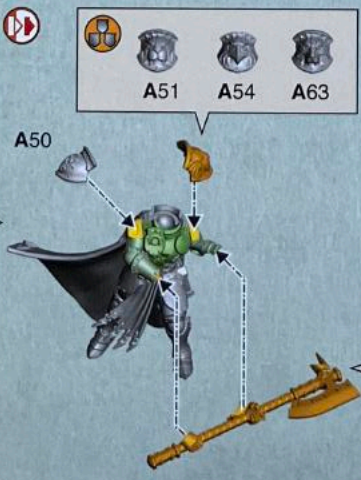



- Choose the variant you want to build
- Choisissez la variante à assembler
- Elige qué versión quieres montar

- Wähle die Variante, die du bauen möchtest
- Scegli la variante che vuoi assemblare
- Выберите тот вариант, который хотите собрать

- 組み立てバリエーションの選択
- 选择你喜欢的拼装方式

3 b



- Errant-Questor Duellist with Twinblades
- Duelliste Questor Errant avec Lames Jumelles
- Hidalgo Errante Duellista con Filos Gemelos
- Fahrender Questor-Duellant mit Zwillingssklingen
- Questor-Errante Duellista con lame gemelle
- странствующий квестор-дуэлянт с парными клинками
- エラント・クエスター・デュエリスト(双剣装備)
- 装备双刃的游侠巡游者决斗家

3 c



- Errant-Questor with Grandhammer
- Questor Errant avec Grand Marteau
- Hidalgo Errante con Gran Martillo
- Fahrender Questor mit Großhammer
- Questor-Errante con granmartello
- странствующий квестор с великим молотом
- エラント・クエスター(大鎚装備)・装备巨锤的游侠巡游者

3



- Errant-Questor with Grandaxe
- Questor Errant avec Grande Hache
- Hidalgo Errante con Gran Hacha
- Fahrender Questor mit Großaxt
- Questor-Errante con grande ascia
- странствующий квестор с великим топором
- エラント・クエスター(大斧装備)・装备巨斧的游侠巡游者

3 a



A23



A24



A25



A28

3 b

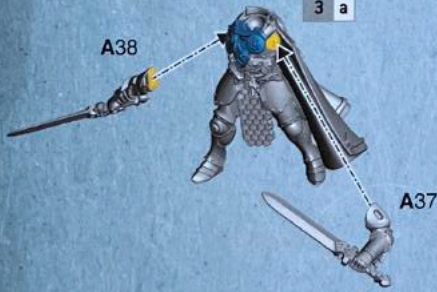

3 a

A38

A37

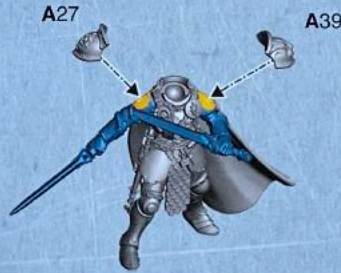

A27

A39



A40

Ø 40mm

3 c



A29

3 a

A30

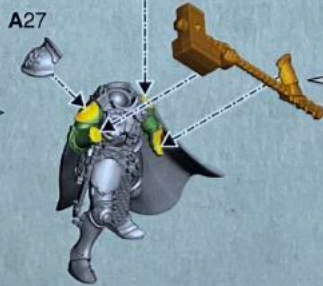

A27

A31

A39

A32

A35

A33

A36



Ø 40mm

4 Royal Flaymaster • Maître-dépeceur Royal • Desollador Real • Königlicher Meisterhüter • Caroscuoiatore Regale • верховный королевский зверодёр • ロイヤル・フレイマスター • 皇家屠杀大师

4 a

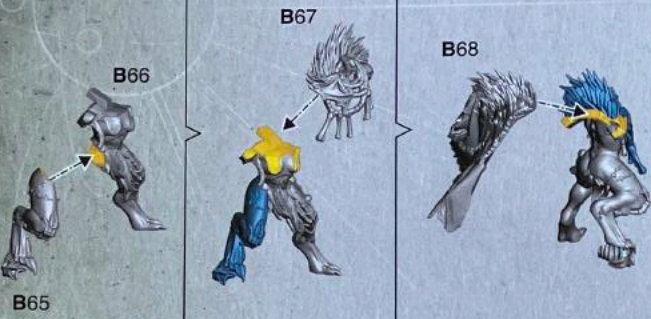

4 b

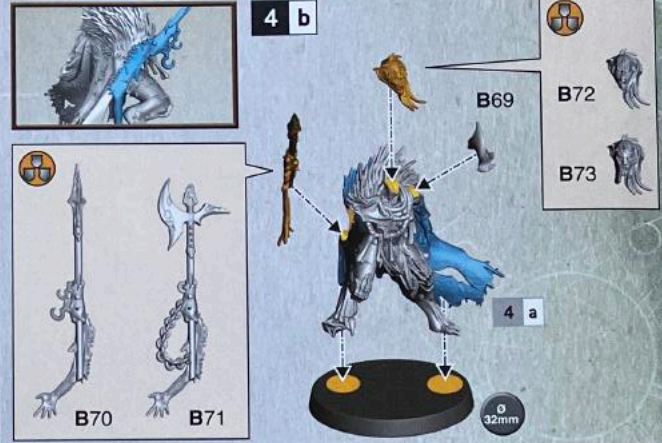

5 - 6 Offal Hound • Chien d'Abattoir • Mastin Cometripas • Gedärmhund • Segugio da Frattaglie • гончая-падальщица • オファルハウンド • 内脏猎犬

5

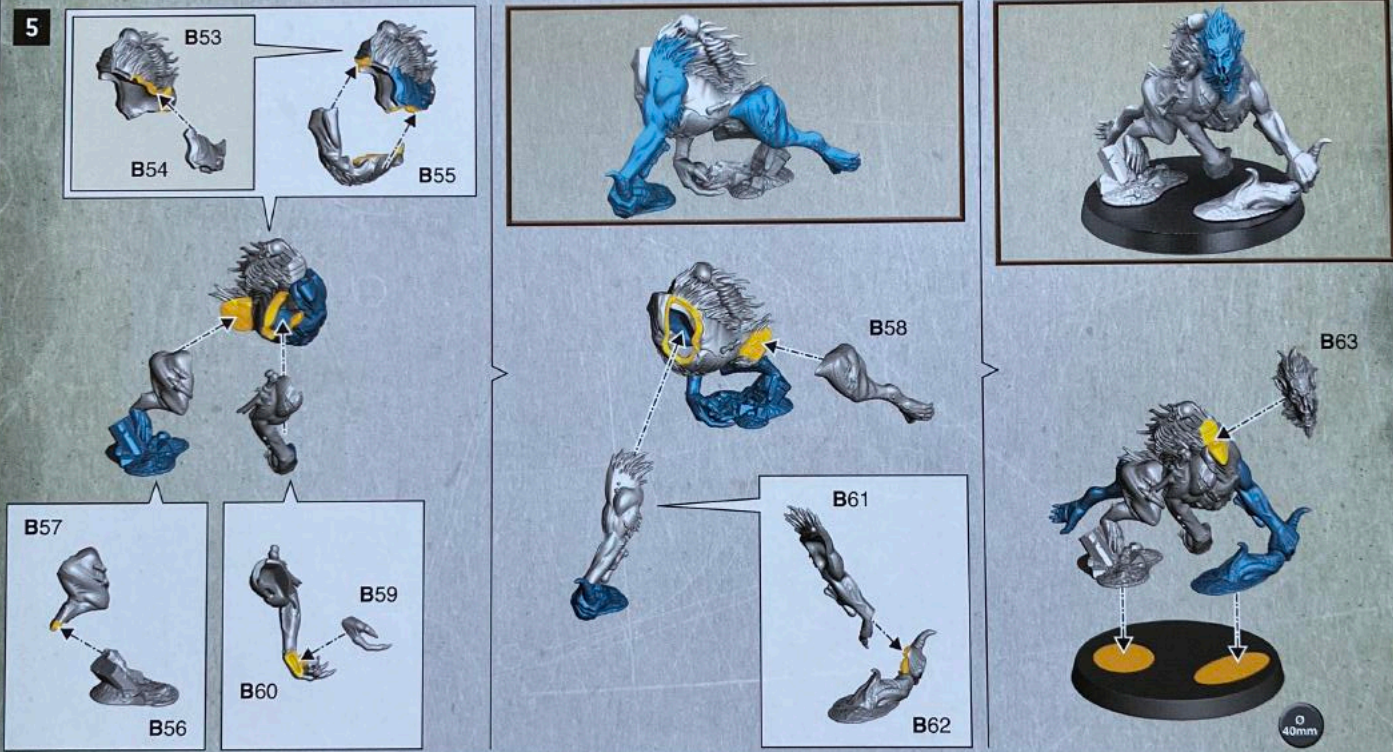

6

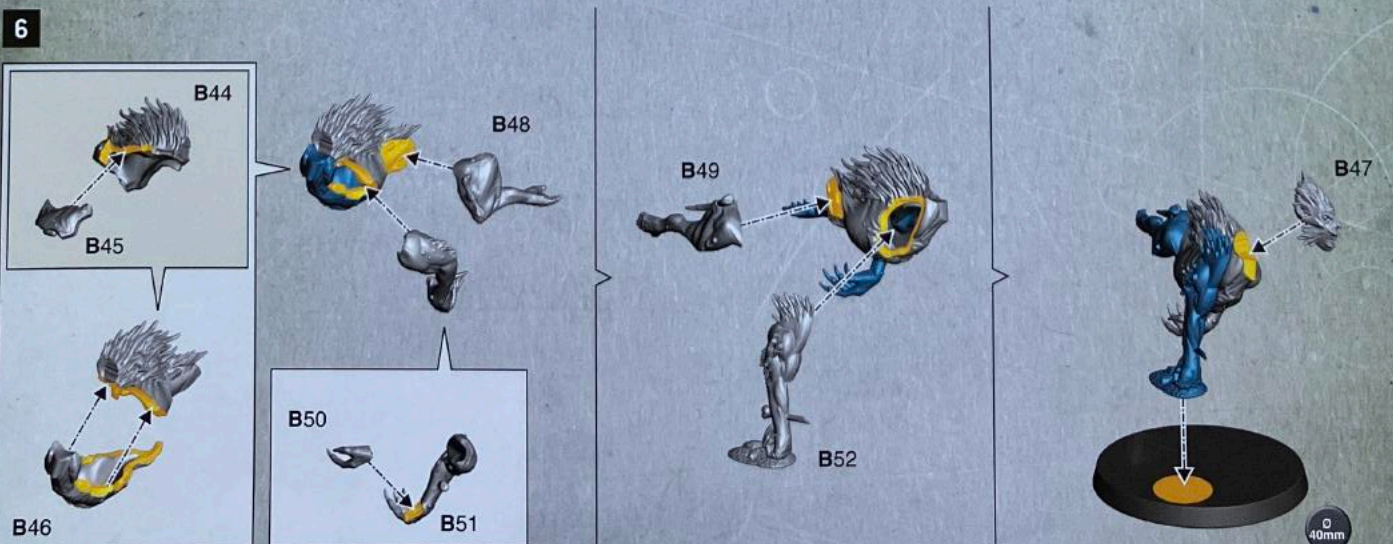

7 a



7 b

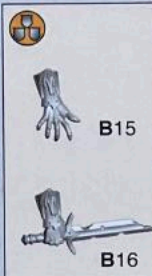

8



9

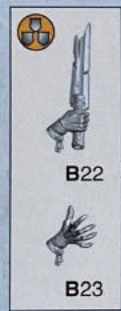
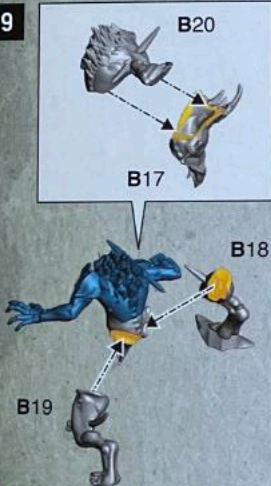

10

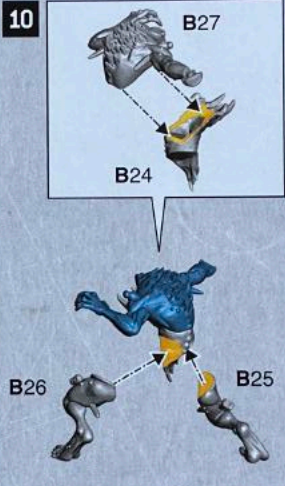

11

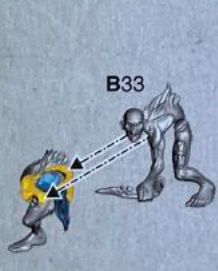

12

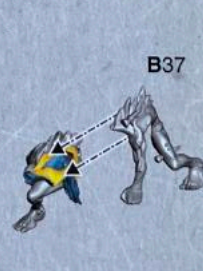

13

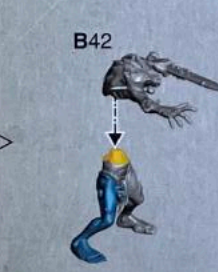

14 a x2

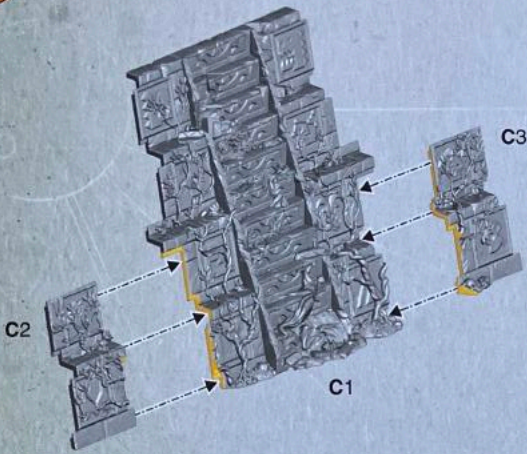

14 b x2

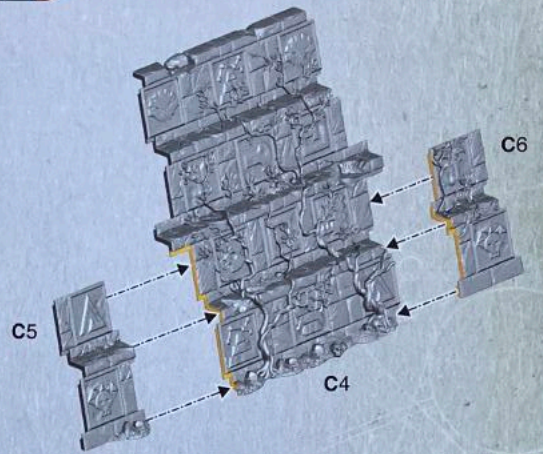

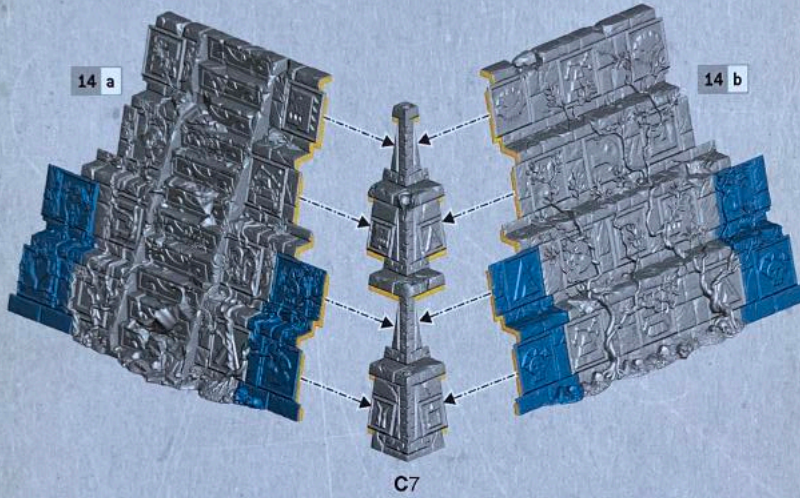

14 c x2

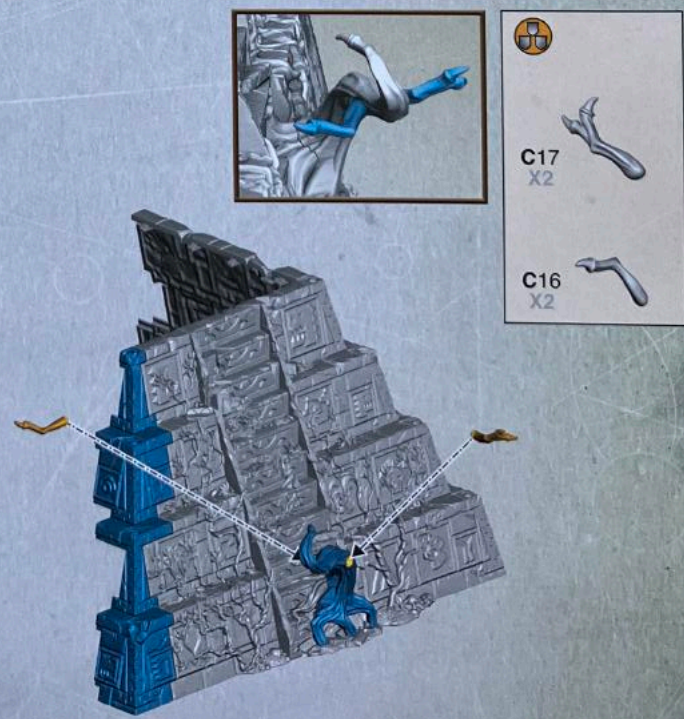
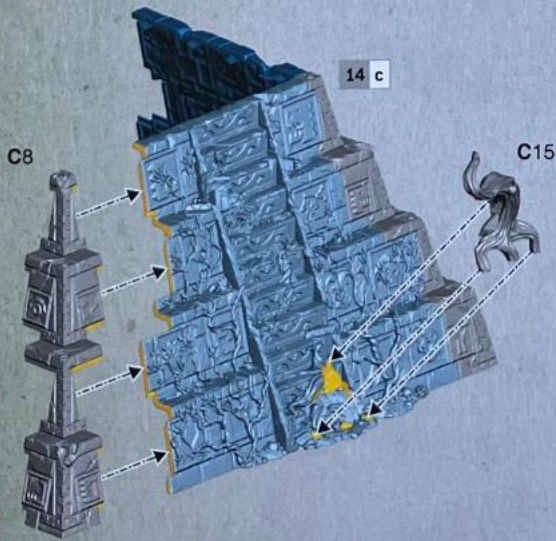

14 d x2



-  C17 X2
-  C16 X2

15

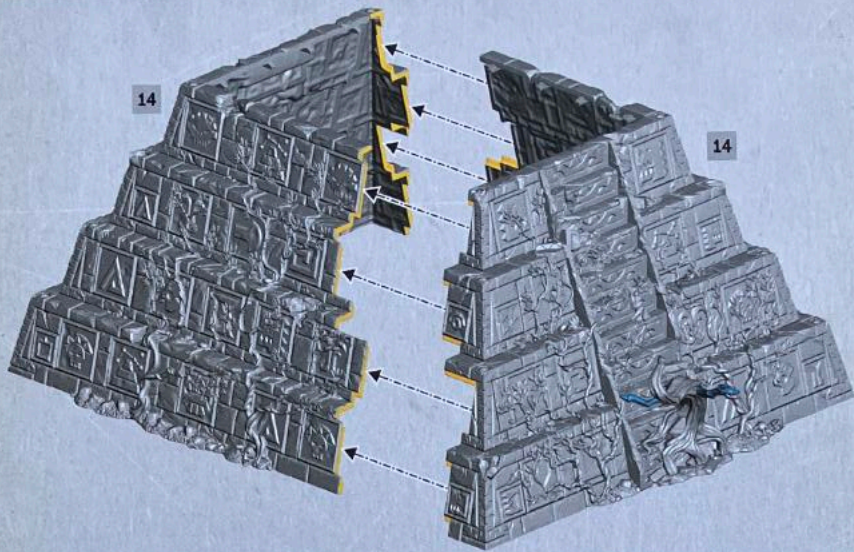

16 a x2

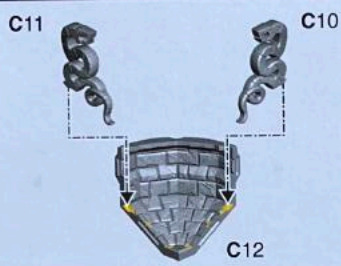
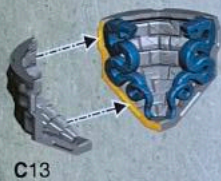

16 b

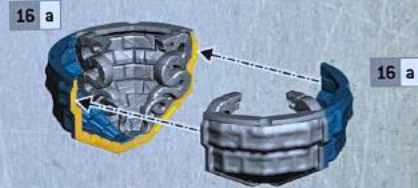

16 c

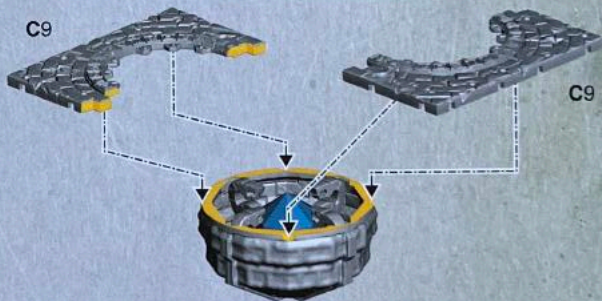
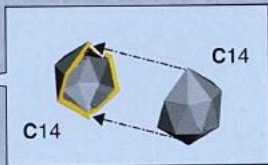

17 a

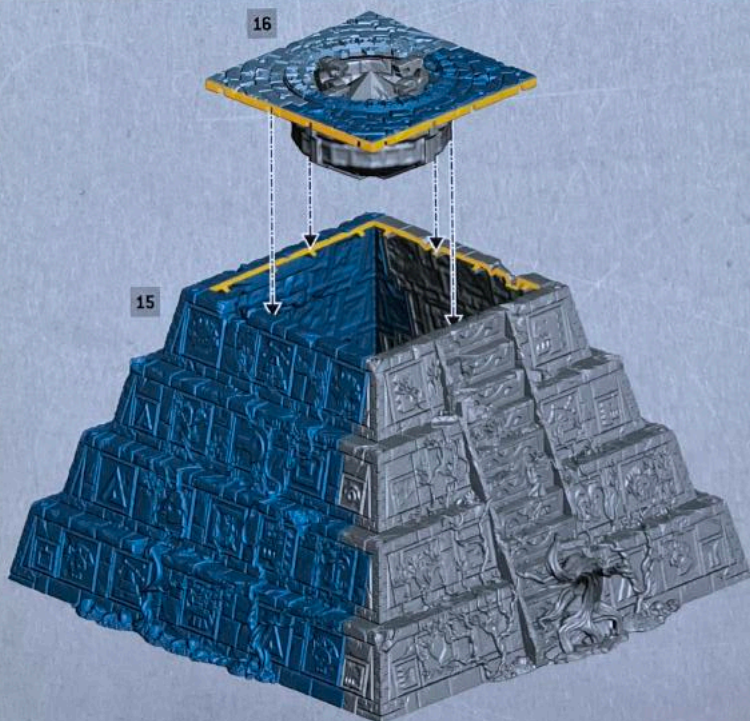

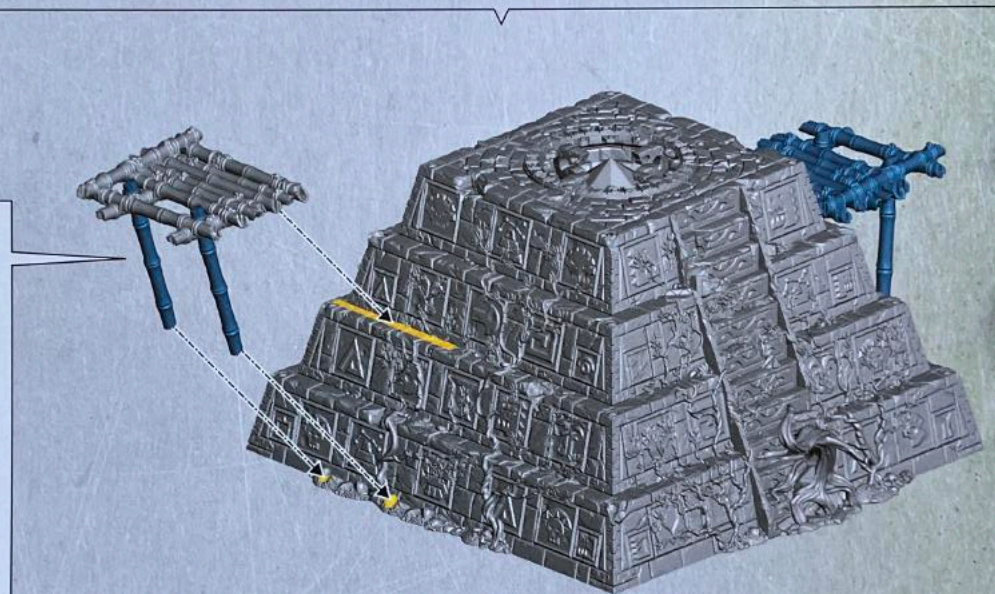
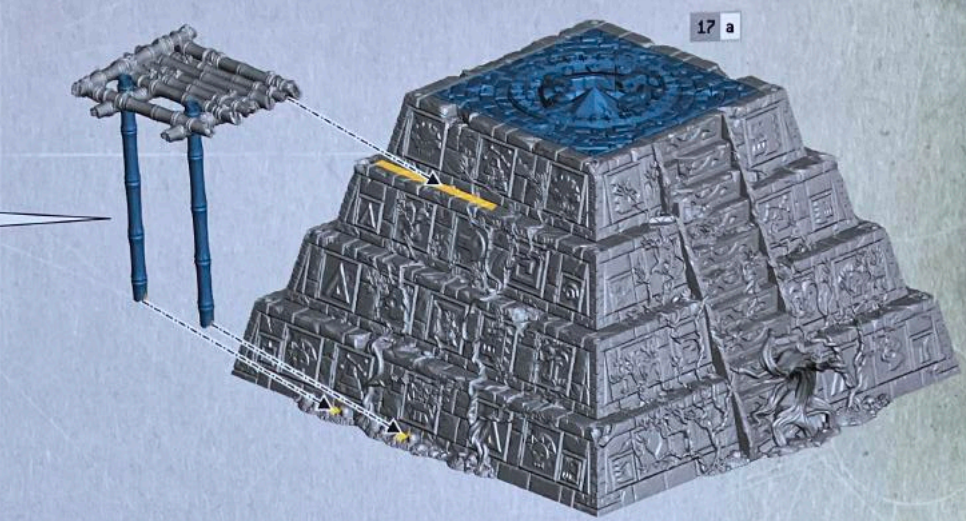
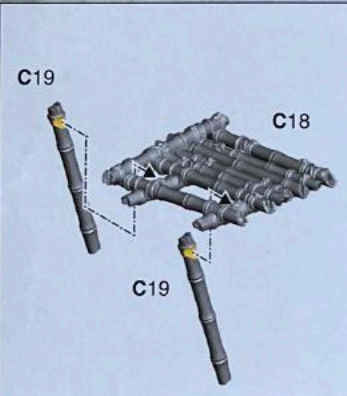
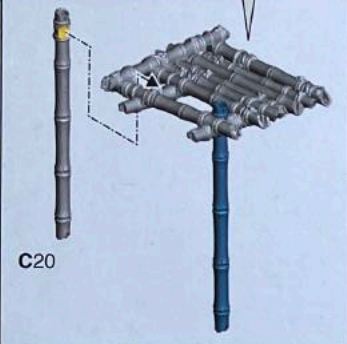
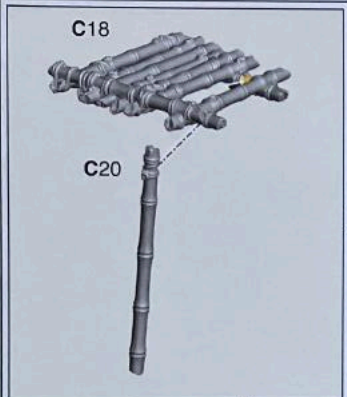

18 a

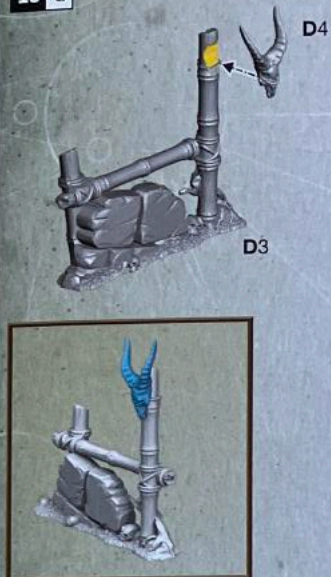

18 b

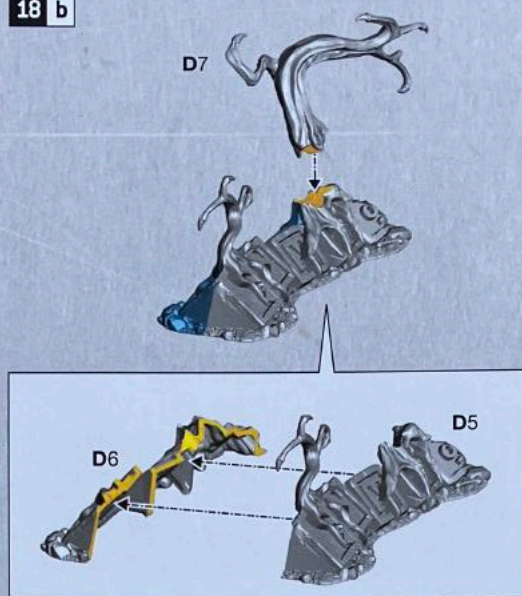

18 c

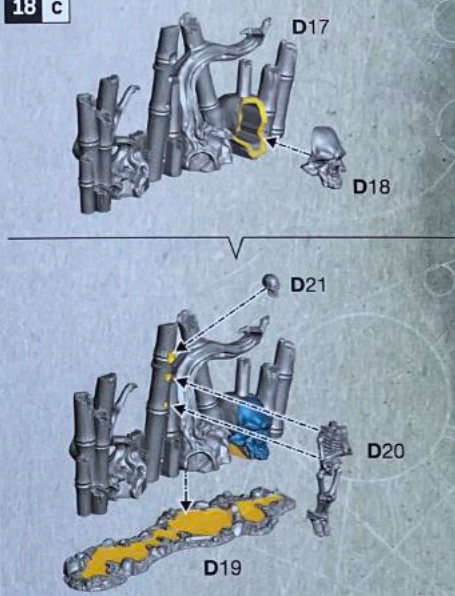

18 d

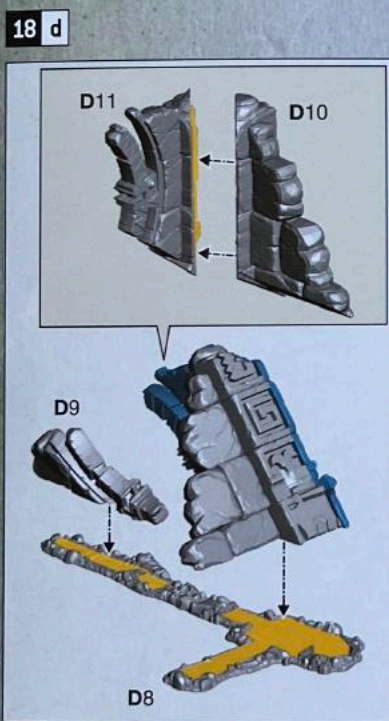

18 e

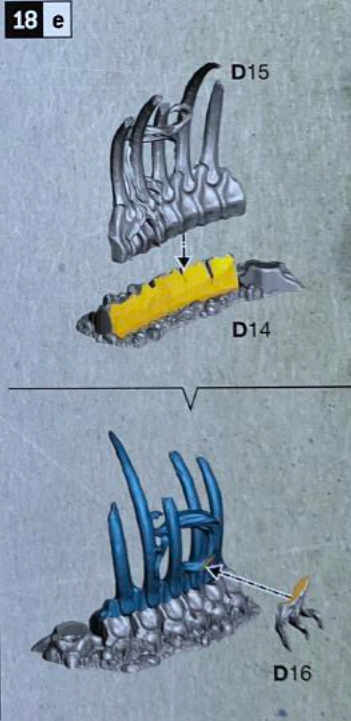

• Ribcages • Cages thoraciques • Costillares
 • Brustkorb • Casse toracique • Рёбра
 • あばらの檻 • 胸骨

• Rope bridges • Ponts de corde • Puentes de cuerdas • Hängebrücken • Ponti di funi
 • Висячие мосты • 繩橋 • 纜橋

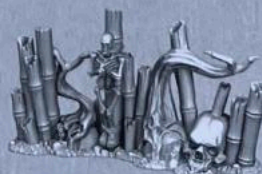
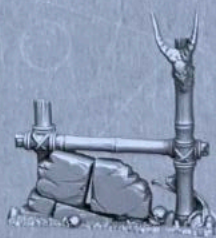

19 a

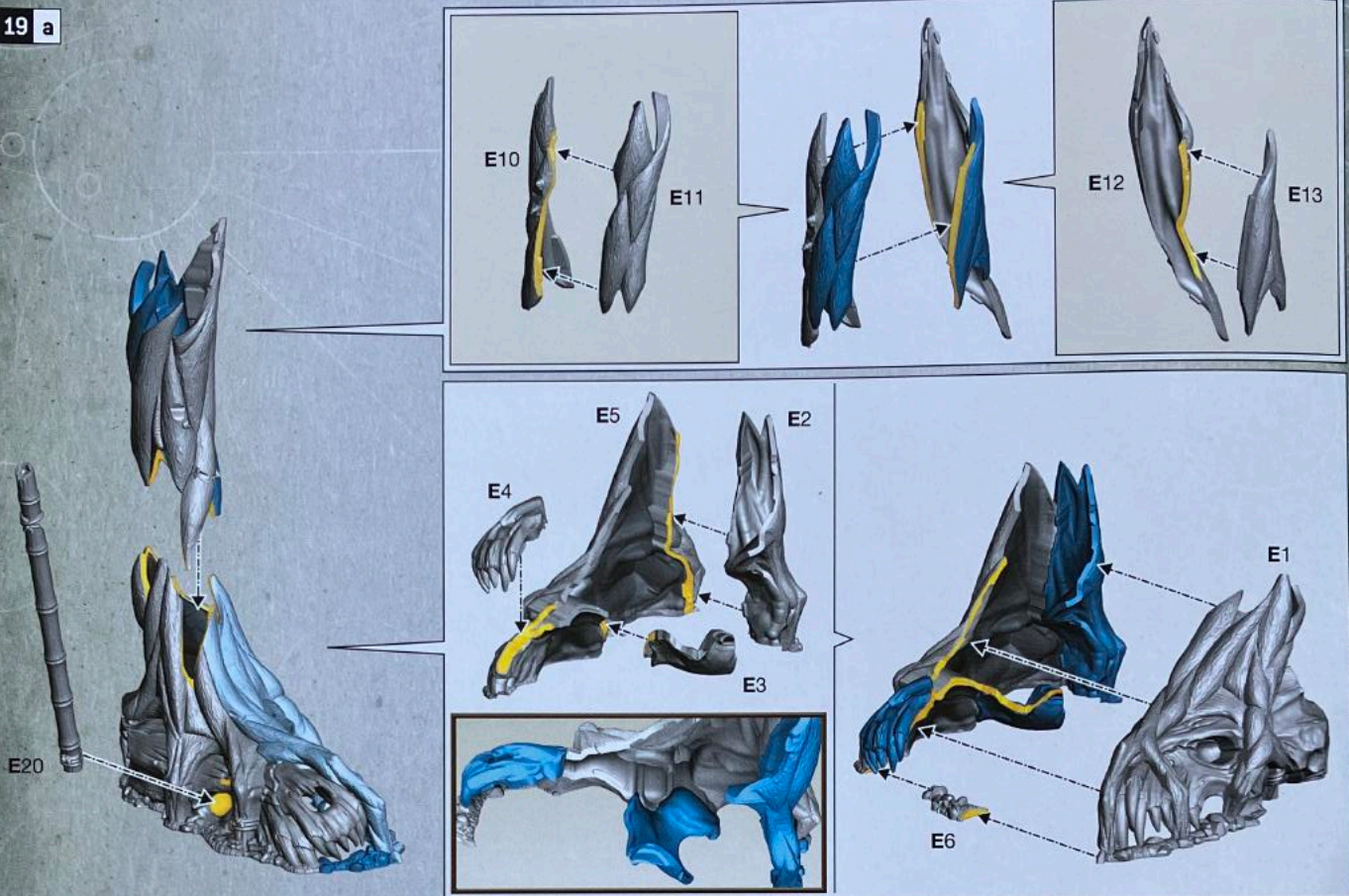

19 b

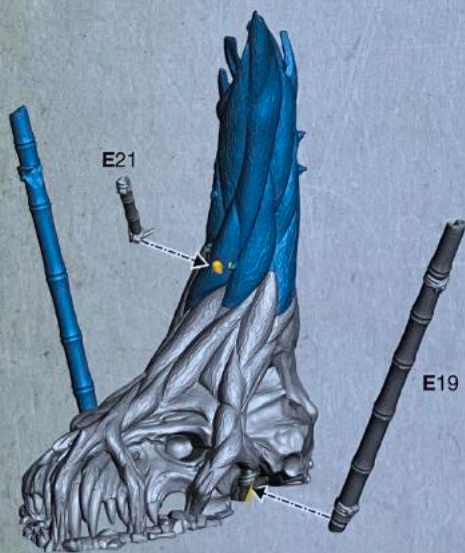

19 a

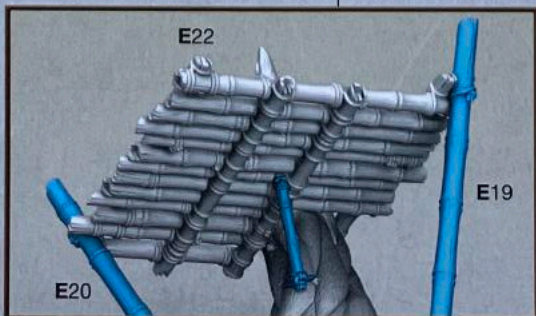

19 c

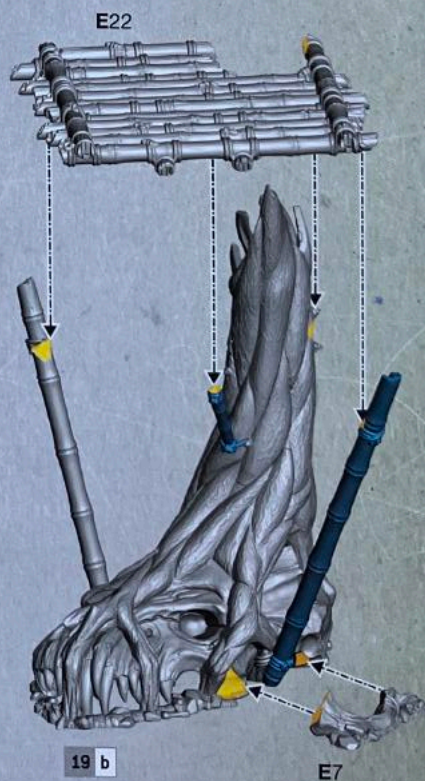

19 b

E7

19 d

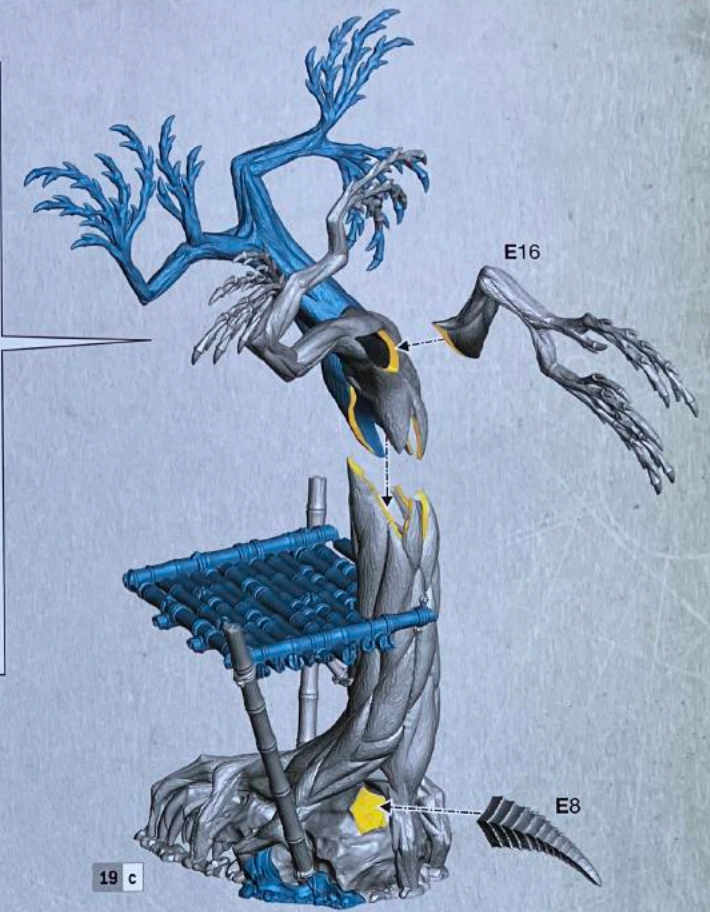
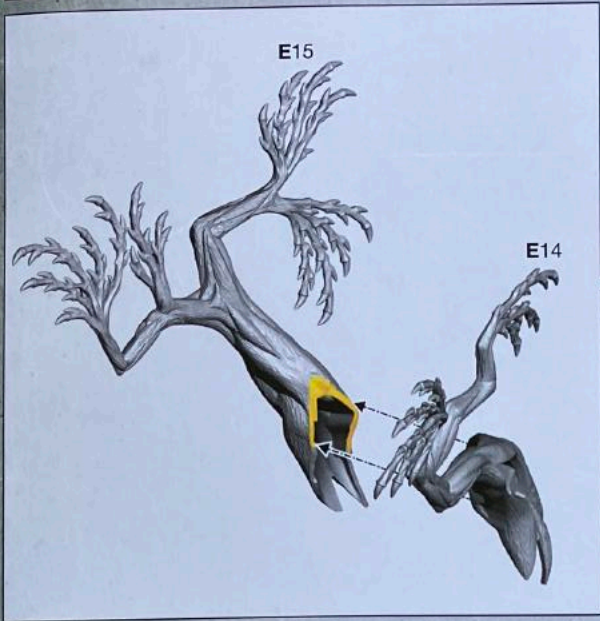

19 e



20 a

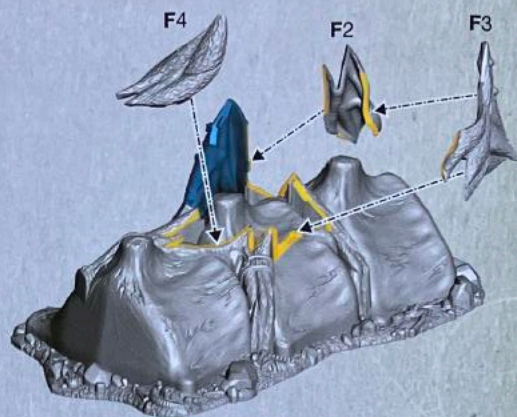
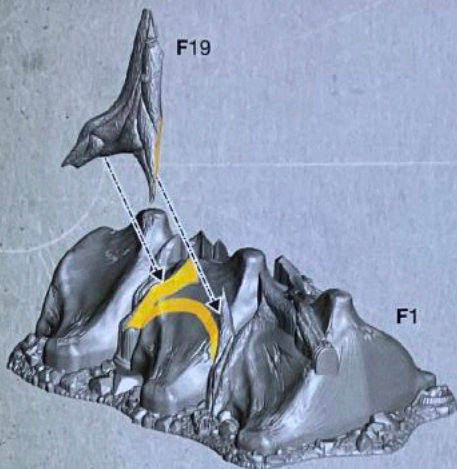

20 b

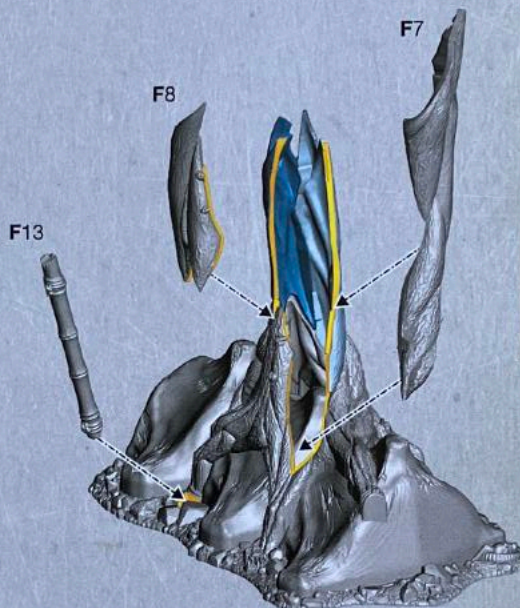
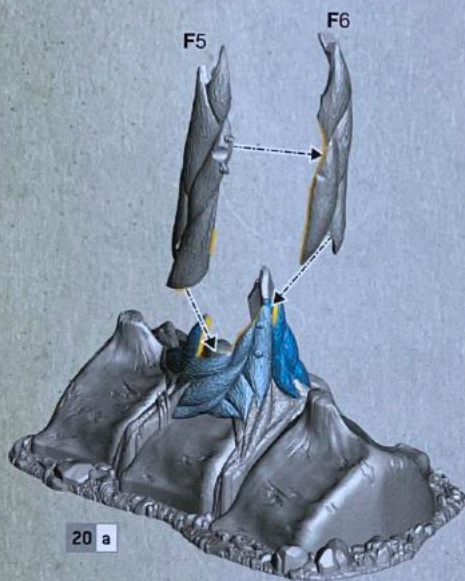

20 a

20 c

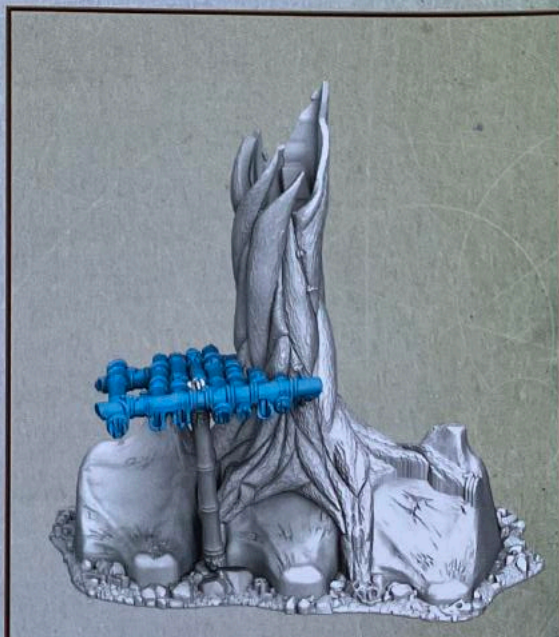
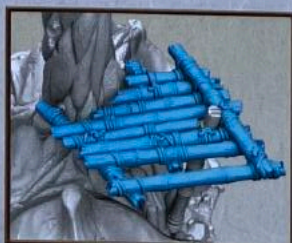
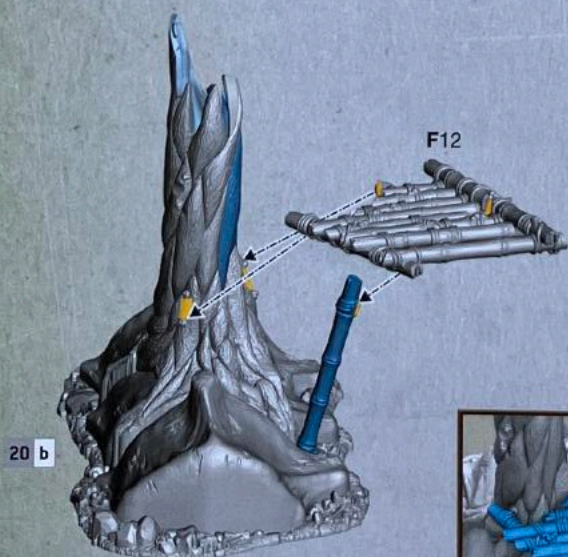

20 b

20 d

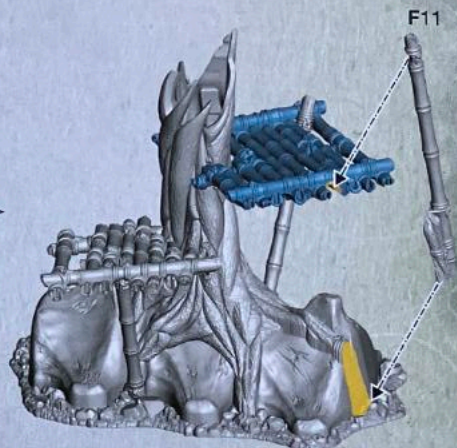
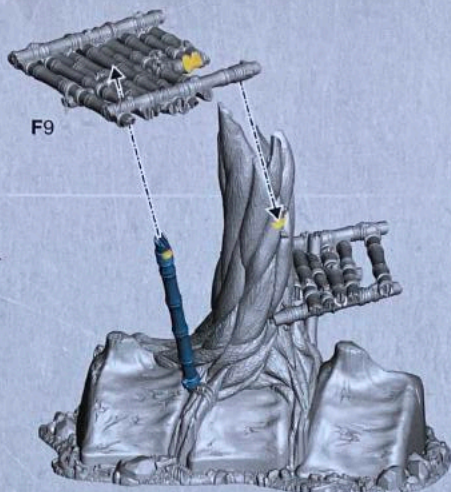
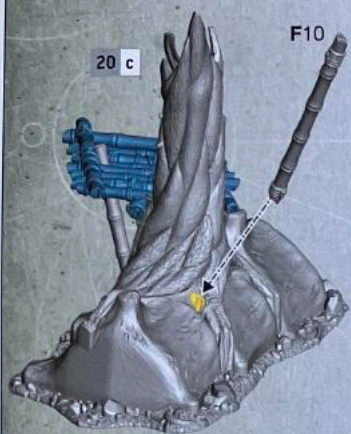

20 e

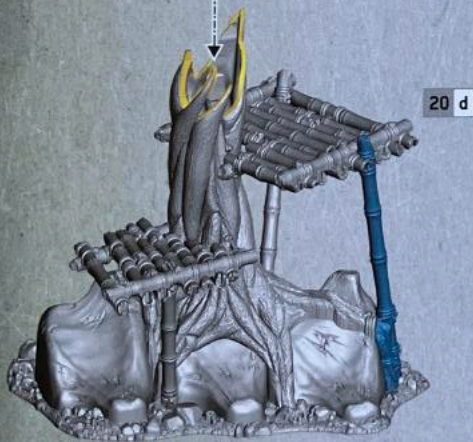
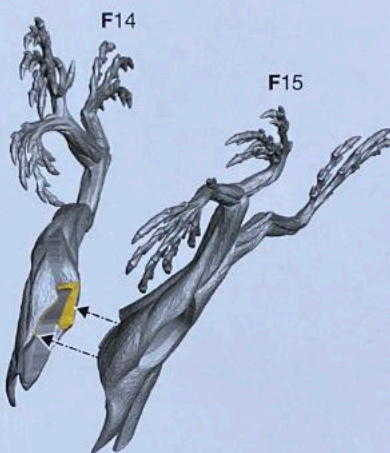

20 f



F18

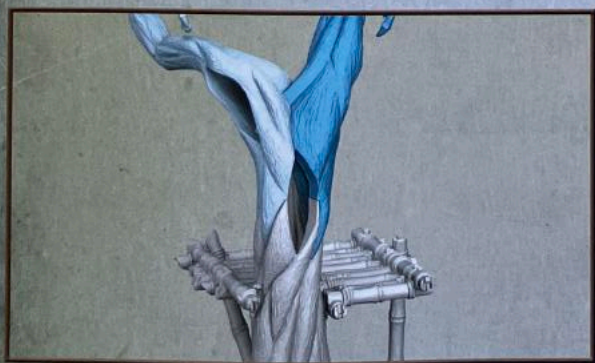

20 g



21  Example Assemblies • Exemples d'Assemblages • Ejemplos de montaje • Beispiele • Esempi di assemblaggio • Образцы сборки • 組み立ての例 • 装配示例

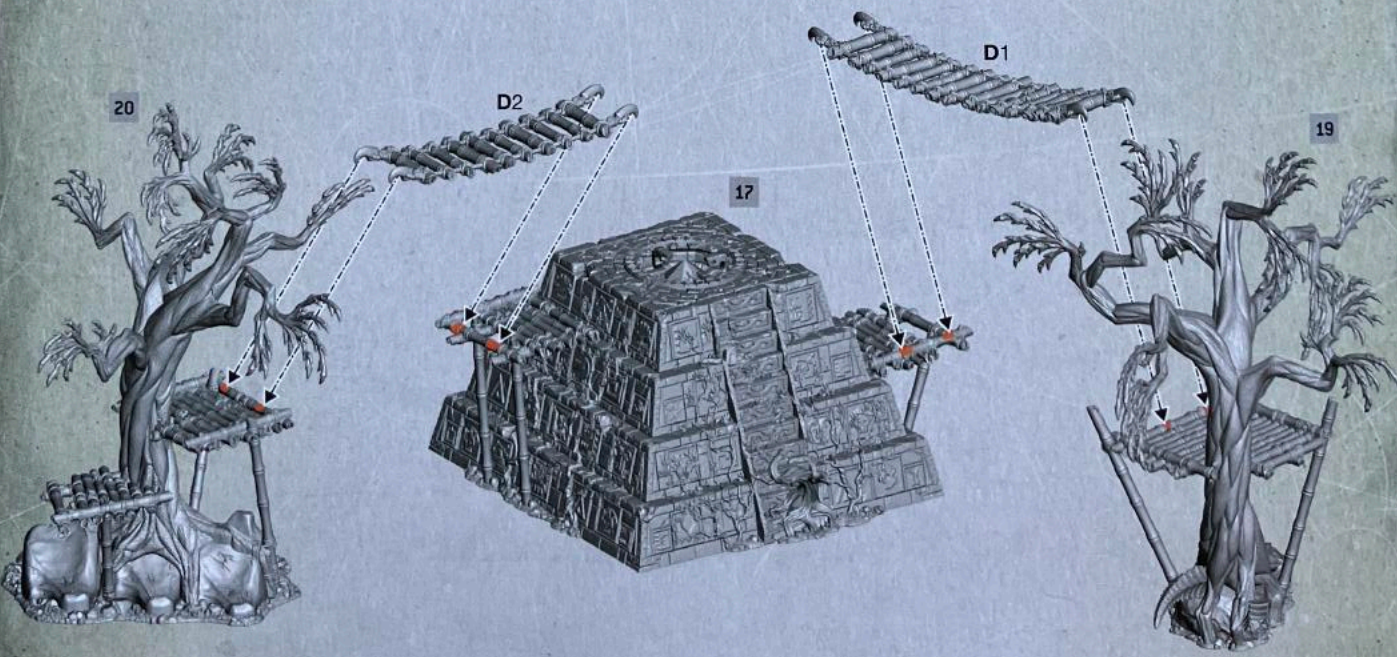

WARHAMMER.COM

Games Workshop Limited, Willow Road, Nottingham, NG7 2WS, UK
© Copyright Games Workshop Limited 2023.

