

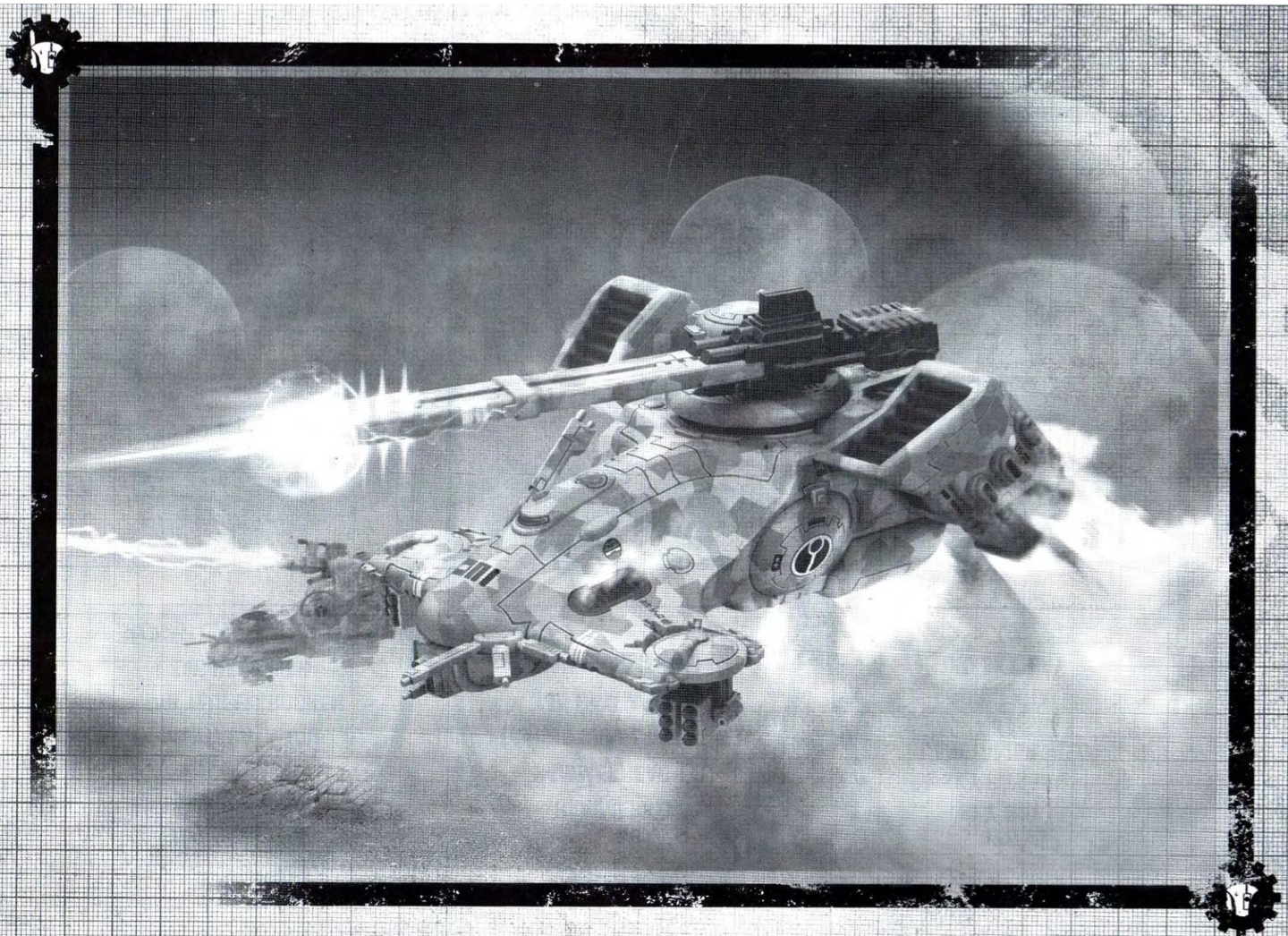

Free Downloads of Build Instructions,
Assembly Booklets & How To Guides

BuildInstructions.com



TAU DEVILFISH
DEVILFISH TAU
TRANSPORTE
MANTARAYA TAU
TAU TEUFELSRÖCHEN
TAU DEVILFISH
タウ デビルフィッシュ

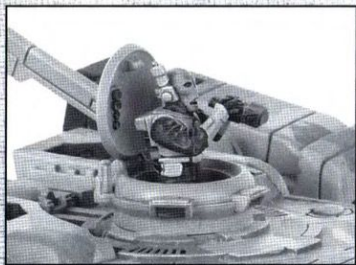

TAU
HAMMERHEAD
HAMMERHEAD TAU
TANQUE CABEZAMARTILLO
TAU HAMMERHEAD
TAU HAMMERHEAD
タウ ハンマーヘッド

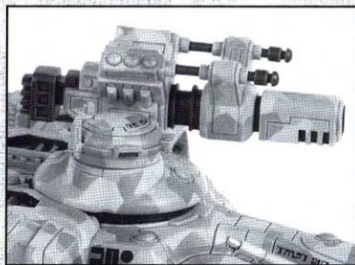

TAU
SKY RAY
SKY RAY TAU
CABEZAMARTILLO
MONT'KA SHAS
DORNENHAI
TAU SKY RAY
タウ スカイレイ



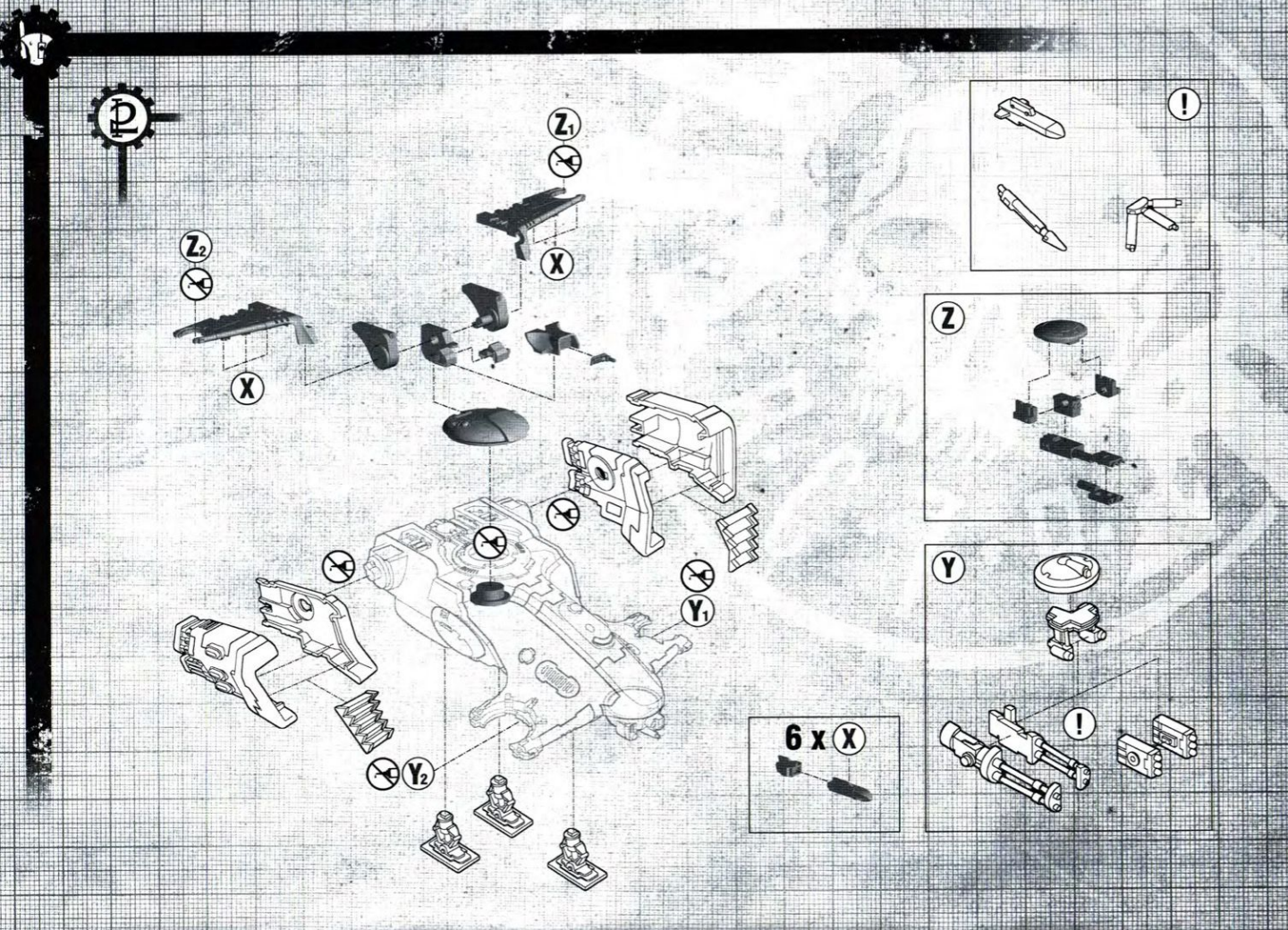

2

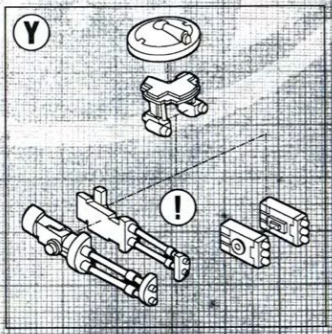
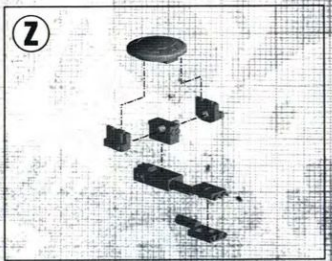
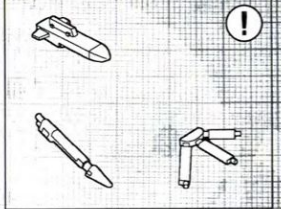
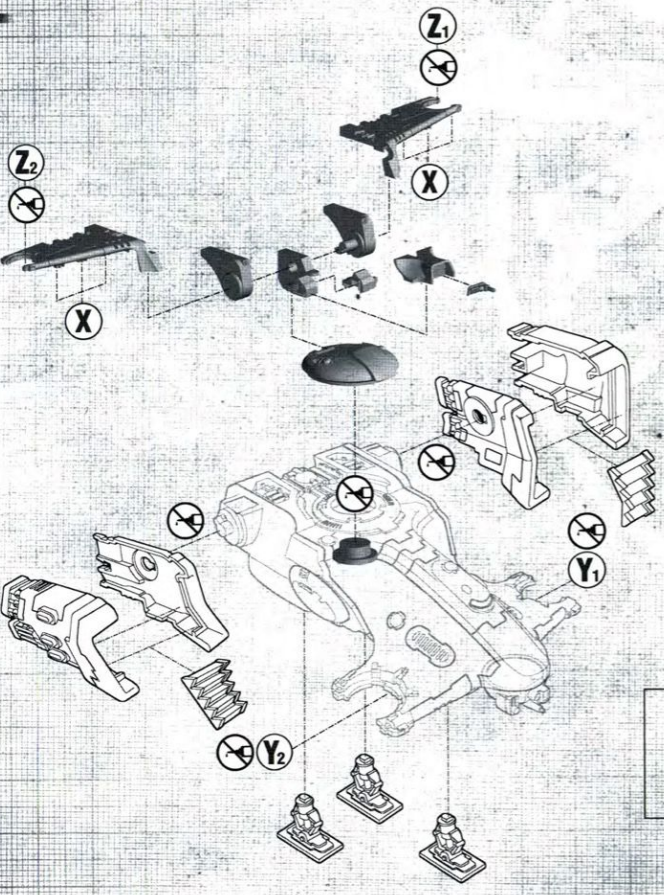

6 x X

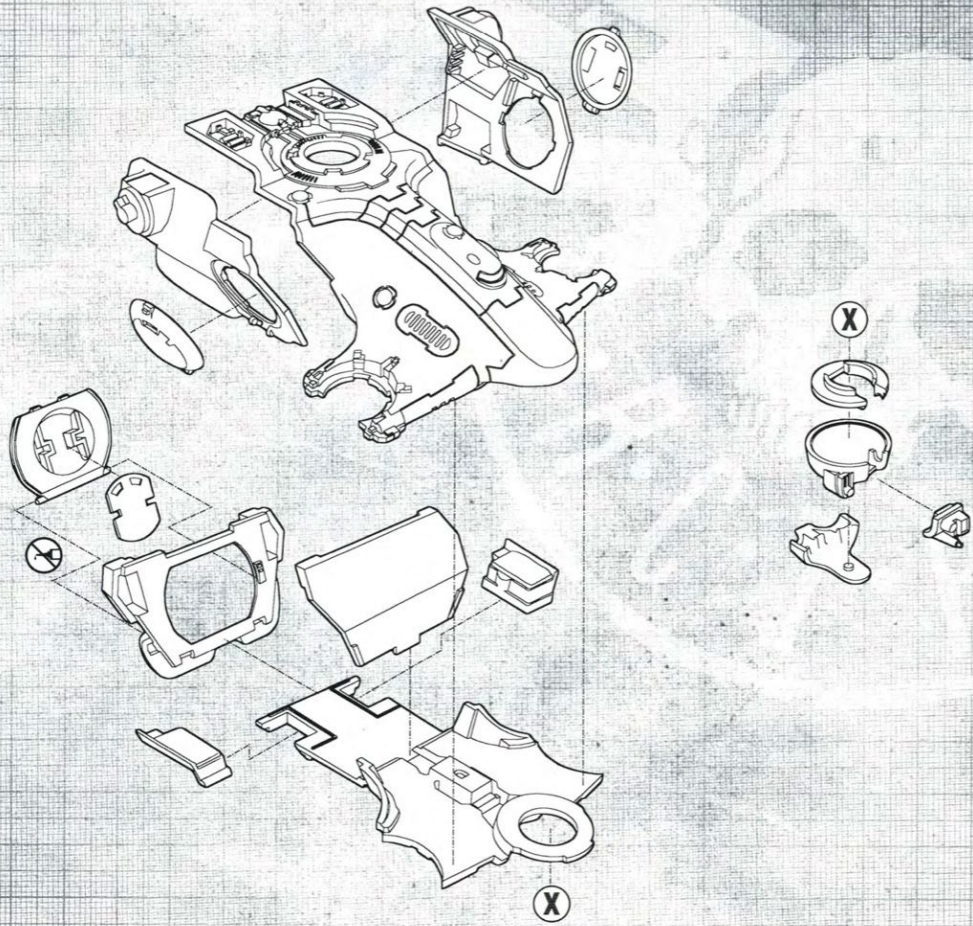

1 x

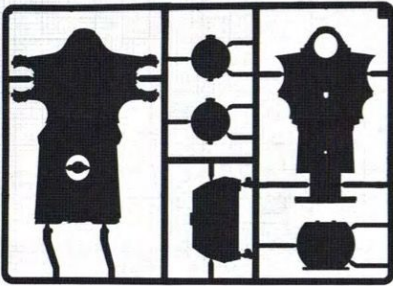

1 x

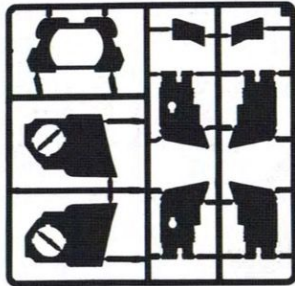

1 x

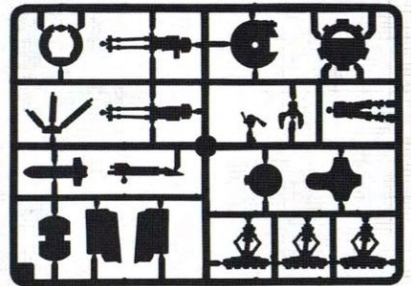

TAU
 SKY RAY
 SKY RAY
 TAU
 CABEZAMARTILLO
 MONT'KA SHAS
 TAU
 DORNENHAI
 TAU
 SKY RAY
 タウ スカイレイ

1 x

TAU SKY RAY
 SKY RAY TAU
 CABEZAMARTILLO MONT'KA SHAS
 TAU DORNENHAI
 TAU SKY RAY
 タウ スカイレイ

1 x



1 x



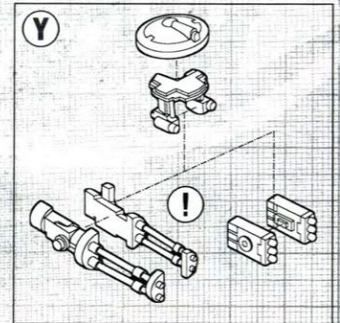
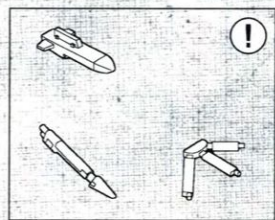
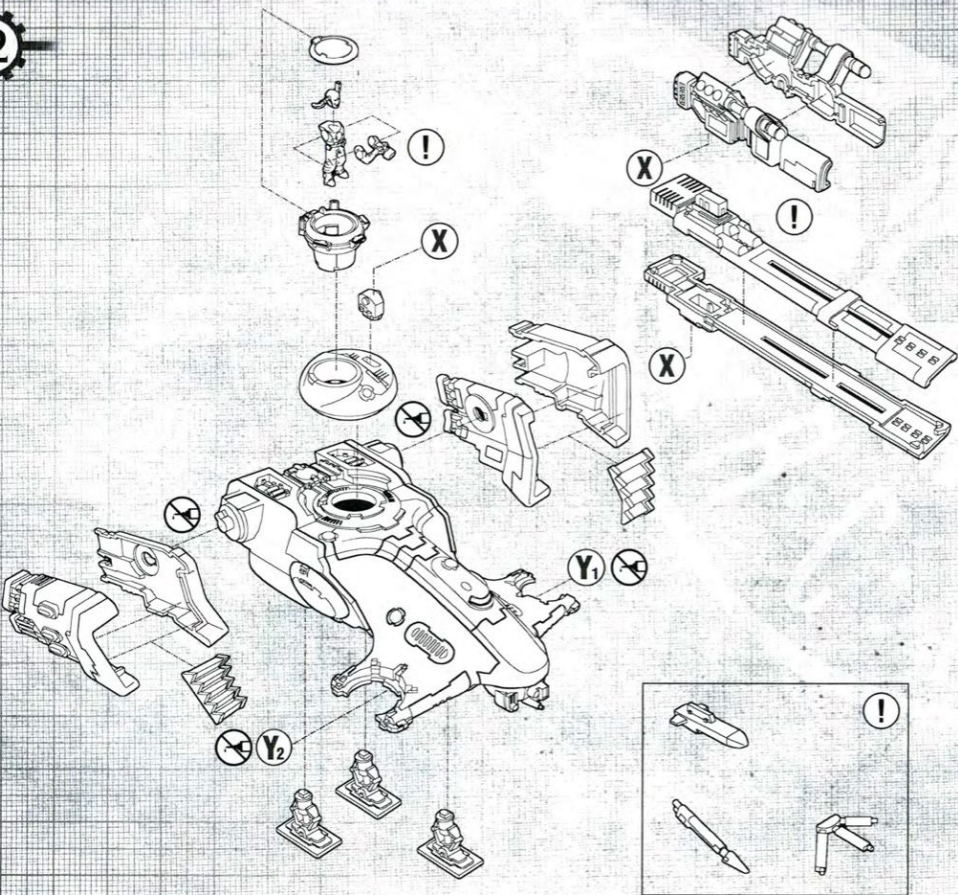

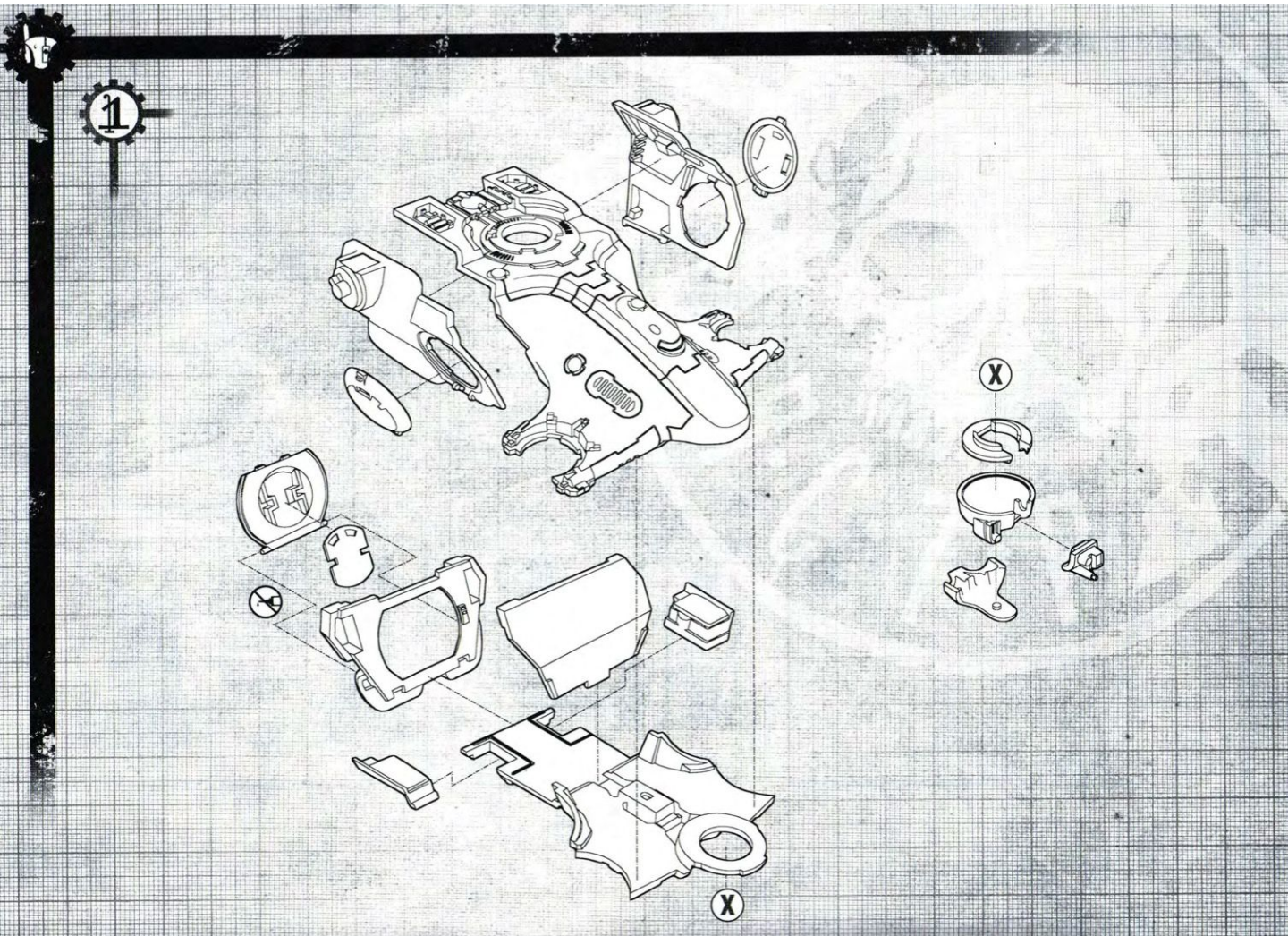

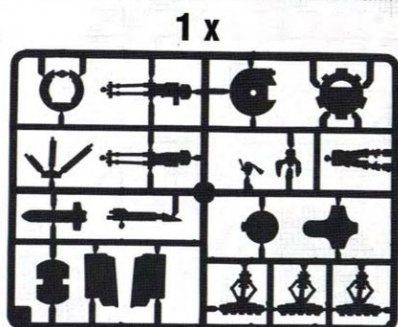
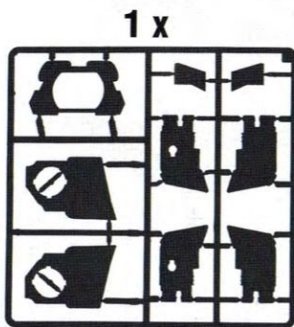
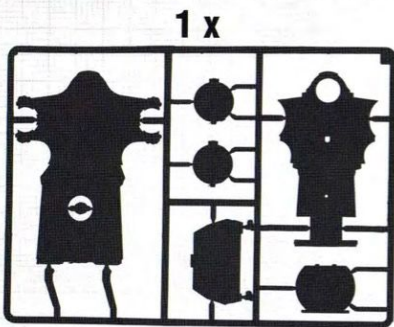

TAU
 HAMMERHEAD
 HAMMERHEAD
 TAU
 TANQUE
 CABEZAMARTILLO
 TAU
 HAMMERHEAD
 TAU HAMMERHAI
 タウハンマーヘッド

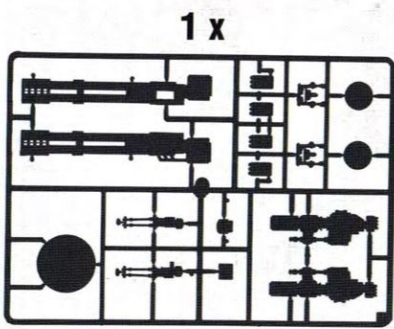

2

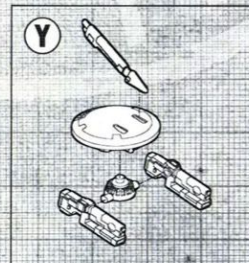
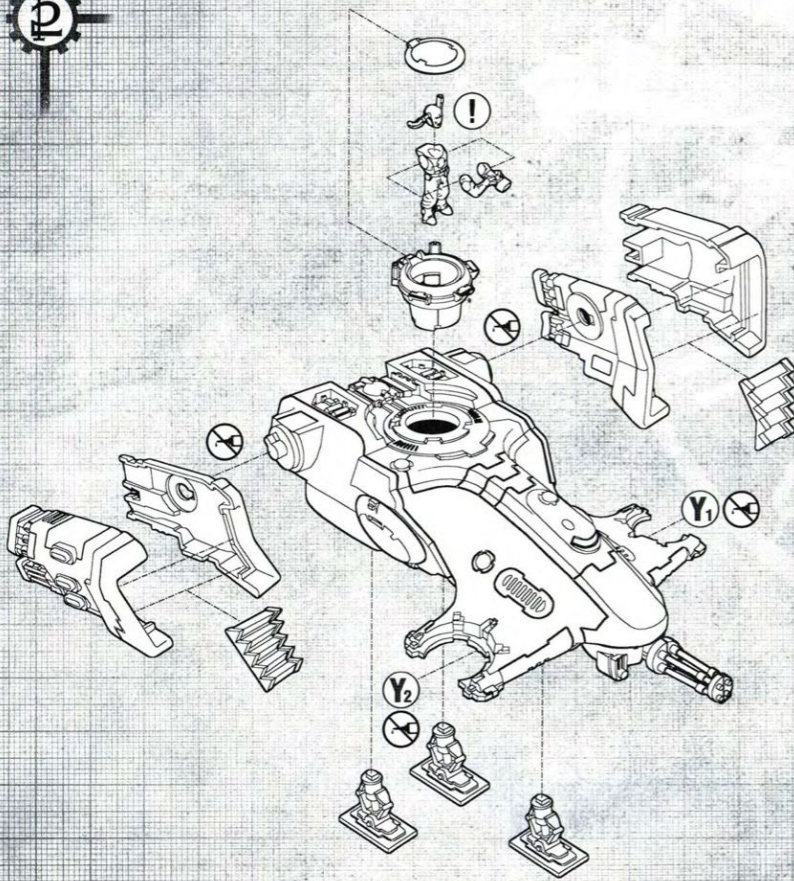

TAU DEVILFISH, TAU HAMMERHEAD & TAU SKY RAY

TAU TEUFELSRÖCHEN, HAMMERHAI UND DORNENHAI

DEVILFISH, HAMMERHEAD & SKY RAY TAU

DEVILFISH TAU, HAMMERHEAD TAU E SKY RAY TAU

INSTRUCCIONES DE MONTAJE DE VEHÍCULO TAU

タウ デビルフィッシュ/タウ ハンマーヘッド/タウ スカイレイ

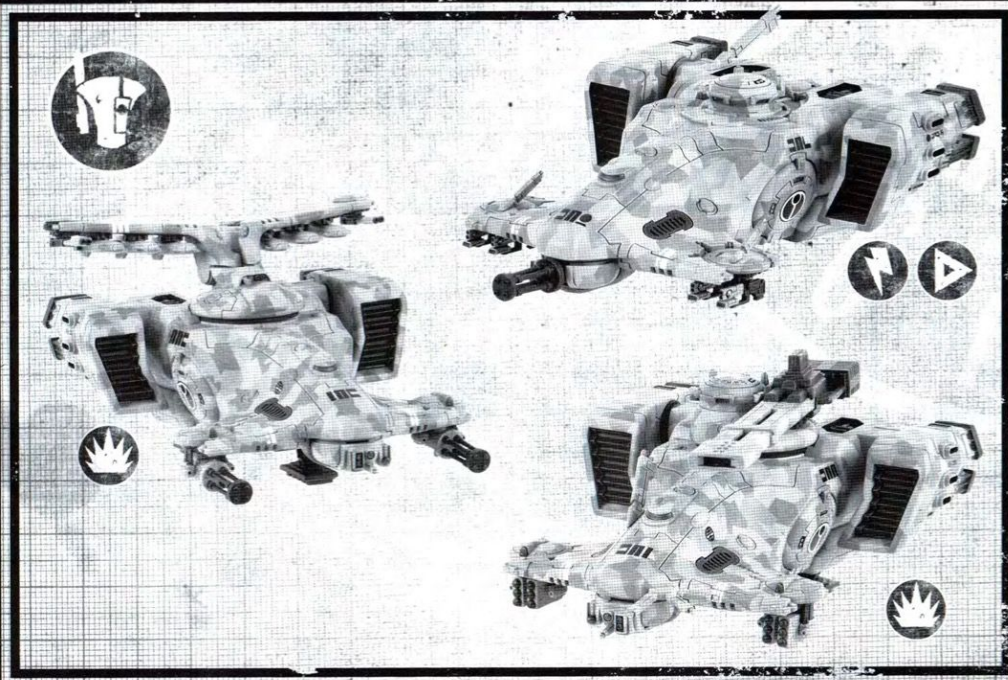

WARHAMMER
40,000



• ENGLISH • Before assembling your model kit, read through these instructions carefully. To assemble this kit you will need some suitable adhesive for the metal or plastic parts and a sharp modelling knife. A pair of clippers can also be useful when removing the components from the sprue. Carefully clean off any plastic mould lines and injection markings using a modelling knife (remember to make cuts away from your body and fingers). Adult supervision is recommended when using adhesive and tools.

• FRANÇAIS • Lisez attentivement ces instructions avant de commencer l'assemblage de votre maquette. Vous aurez besoin pour ce faire de colle adaptée pour les éléments en plastique ou en métal, ainsi que d'un couteau de modélisme. Une paire de pinces coupantes pourra être également utile pour détacher les éléments de leur grappe. Enlevez les traces de moulage et d'injection à l'aide d'un couteau de modélisme (n'oubliez pas de toujours couper vers l'extérieur, jamais vers vous). L'utilisation d'outils ou de colle doit se faire sous la surveillance d'un adulte.

• ESPAÑOL • Antes de montar este kit, lee las instrucciones cuidadosamente. Para el montaje necesitas un pegamento para los componentes de metal y plástico y una cuchilla de modelismo. También puedes usar unas tenacillas para desmontar los componentes de la matriz. Retira las líneas de molde y rebabas con la ayuda de una cuchilla de modelismo (para evitar accidentes, recuerda siempre hacerlo en dirección contraria a tu cuerpo). Se recomienda la supervisión de un adulto al usar el pegamento y las herramientas.

• DEUTSCH • Vor dem Zusammenbau deines Modells solltest du dir diese Bauanleitung genau durchlesen. Um diesen Bauatz zusammenzubauen, benötigst du passenden Klebstoff für die Metall- sowie Plastikteile sowie ein scharfes Bastelmesser. Eine Kneifzange ist ebenfalls nützlich. Entferne die Einzelteile mit der Kneifzange aus dem Gussrahmen und säubere sie mit dem Bastelmesser sorgfältig von allen Quasernen und Grateln (denk daran, immer vom Körper und Fingern weg zu schneiden). Kinder sollten Klebstoff und Werkzeuge nur unter Aufsicht eines Erwachsenen verwenden.

• ITALIANO • Prima di assemblare il modello, leggi attentamente queste istruzioni. Per assemblare gli sprue, avrete bisogno di colle adatte per i componenti in metallo e plastica e di un coltello da modellismo affilato. Possono essere utili anche un paio di tenacine quando si rimuovono i componenti dallo sprue. Ripulite attentamente qualsiasi linea e sbogo di fusione con un coltello da modellismo affilato (ricordatevi di usare verso l'esterno, lontano dal corpo e dalle dita). Si raccomanda la supervisione di un adulto quando si utilizzano colle e strumenti da modellismo.

• 日本語 • 組み立て説明をよくお読みになったから、このキットを組み立ててください。このキットを組み立てるには、メタルパーツやプラパーツに適した接着剤とモデリングナイフが必要です。ニッパーも用意しておくと、ランナーからパーツを切り離す時に便利です。モデリングナイフを使って、パーティングラインやバリを丁寧に削り取ってください（体や手とは反対方向に刃を向けるとよりよいです）。保護者の監督のもとで、接着剤や工具を使用することをおすすめします。



993101130038