

Free Downloads of Build Instructions,  
Assembly Booklets & How To Guides

**BuildInstructions.com**



- Assemblies for build variants are colour coded.
- Les assemblages de variantes ont un code couleur.
- Las instrucciones para montajes alternativos se indican con un color diferente.

- Optionen für Bauvarianten sind farblich markiert.
- Le diverse varianti d'assemblaggio sono divise per colore.
- バリエーション違いの組み立ては色分けされている。
- 変体版拼装部件有颜色区分。

## VENERABLE DREADNOUGHT

DREADNOUGHT VÉNÉRABLE  
 DREADNOUGHT VENERABILE

DREADNOUGHT VENERABLE  
 ヴェネラブル・ドレッドノート

EHRWÜRDIGER DREADNOUGHT  
 神圣无畏机甲

STEPS | ÉTAPES | PASOS | SCHRITTE | FASI | ステップ | 步骤 **1 - 5**



## BJORN THE FELL-HANDED

- BJORN MAIN TERRIBLE
- BJORN GARRA IMPLACABLE
- BJORN WOLFSKLAUE
- BJORN DALLA MANO CRUDELE
- 凶手ビョルン
- 凶残比约恩

STEPS | ÉTAPES | PASOS  
 SCHRITTE | FASI | ステップ | 步骤

**1 - 4 ; 6**



## MURDERFANG

- MEURTRECROC
- COLMILLO ASESINO
- TODESFANG
- ZANNA ASSASSINA
- マーダーファング
- 杀戮牙

STEPS | ÉTAPES | PASOS  
 SCHRITTE | FASI | ステップ | 步骤

**1 - 4 ; 7**







## WULFEN DREADNOUGHT

- DREADNOUGHT WULFEN
- DREADNOUGHT WULFEN
- WULFEN-DREADNOUGHT
- WULFEN DREADNOUGHT
- ウルフェン・ドレッドノート
- 狼人无畏机甲

STEPS | ÉTAPES | PASOS  
SCHRIITTE | 段階 | ステップ | 手順

1 - 4 ; 8



CONTENTS | CONTENU | CONTENIDO | INHALT | CONTENUTO | コンテンツ | 内含板件

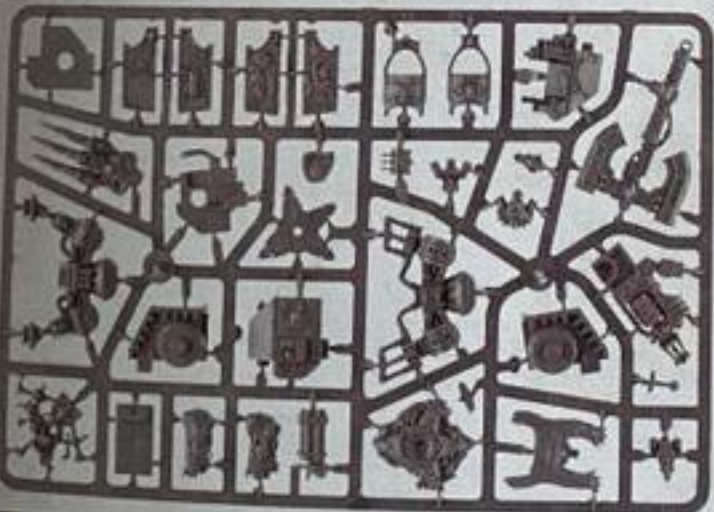

EXPLANATION OF SYMBOLS | EXPLICATION DES SYMBOLES | EXPLICACIÓN DE SÍMBOLOS  
ERLÄUTERUNG DER SYMBOLE | LEGENDA DEI SIMBOLI | アイコン解説 | 符号说明



- Variant assembly
- Variante d'assemblage
- Variante de montaje
- Bauvariante
- Assemblaggio alternativo
- 組み立てバリエーション
- 多种组装方式



- Choice of parts
- Choix d'éléments
- Modelos de componentes
- Auswahl an Teilen
- Scelta di componenti
- パーツの選択
- 选择部件



- Stage complete
- Étape terminée
- Paso completado
- Schritt abgeschlossen
- Fase completa
- このステージの完成
- 完成

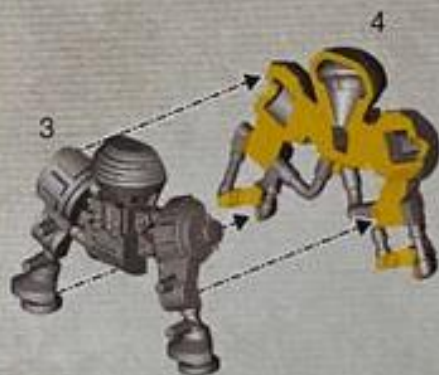
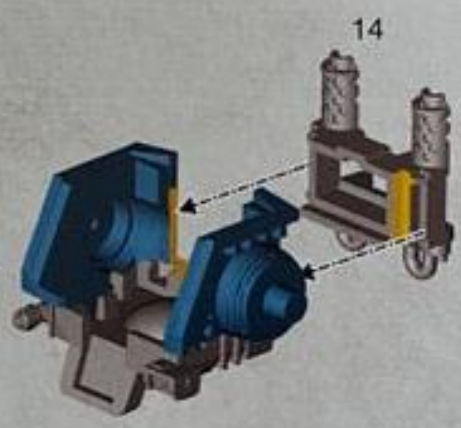
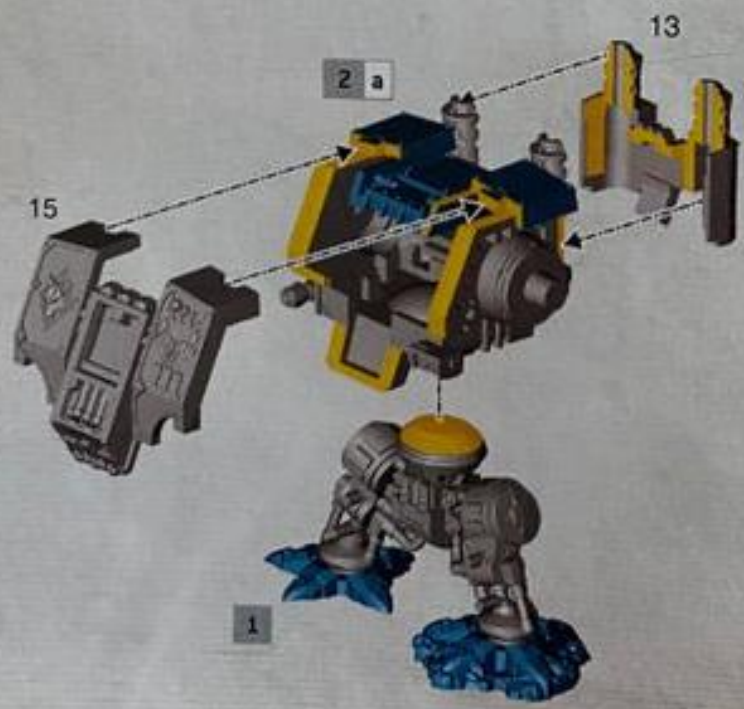

**1****2 a****2 b**



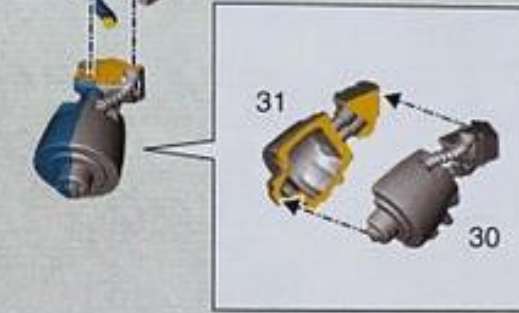
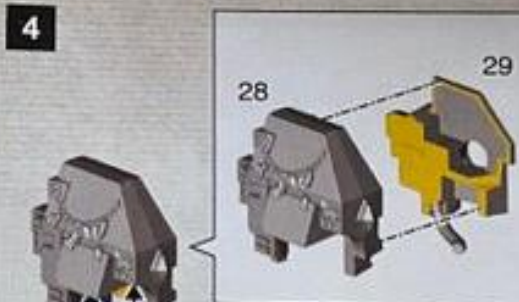

**5 VENERABLE DREADNOUGHT**

DREADNOUGHT VÉNÉRABLE | DREADNOUGHT VENERABLE | EHRWÜRDIGER DREADNOUGHT  
 DREADNOUGHT VENERABILE | ヴェネラブル・ドレッドノート | 神圣无畏机甲

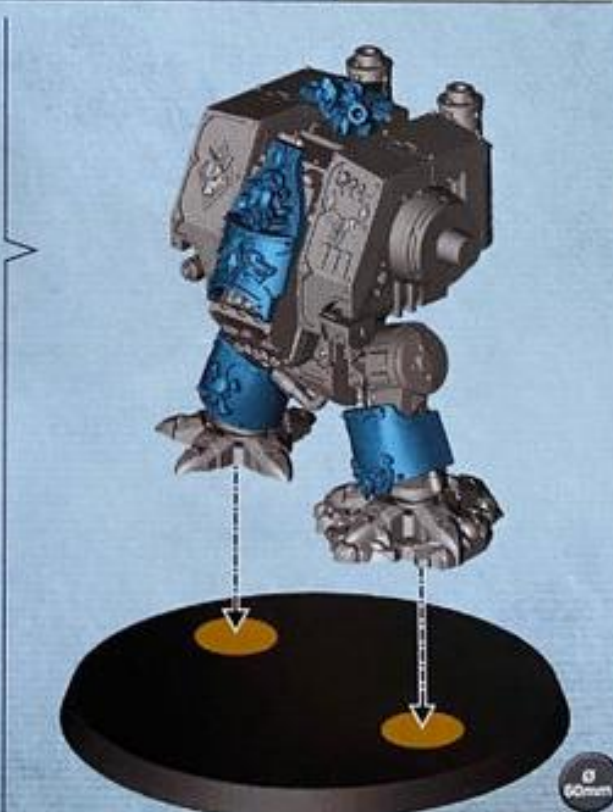
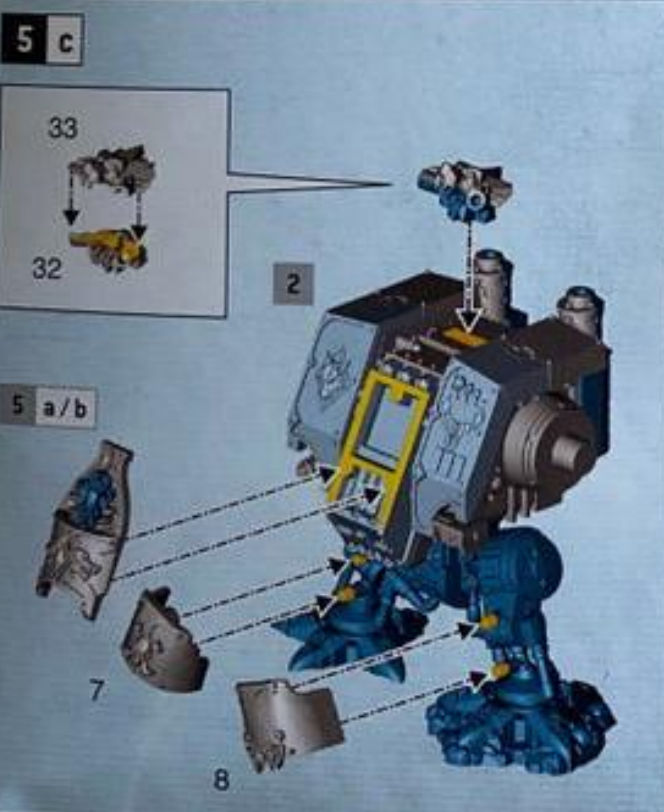
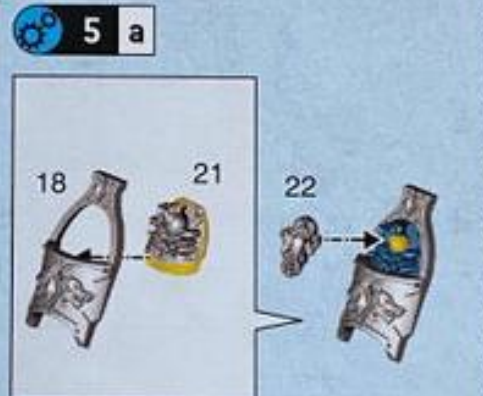

Ø 60mm



5 d



5 e



5 d

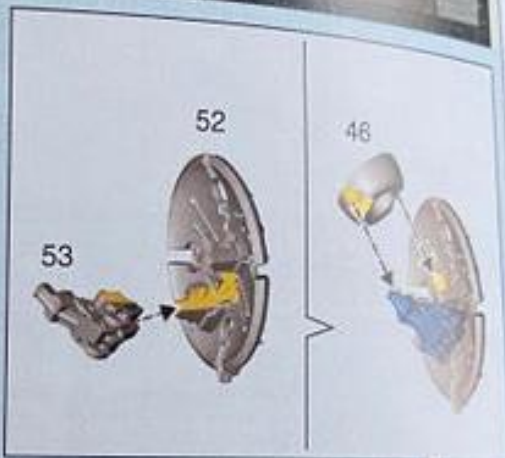
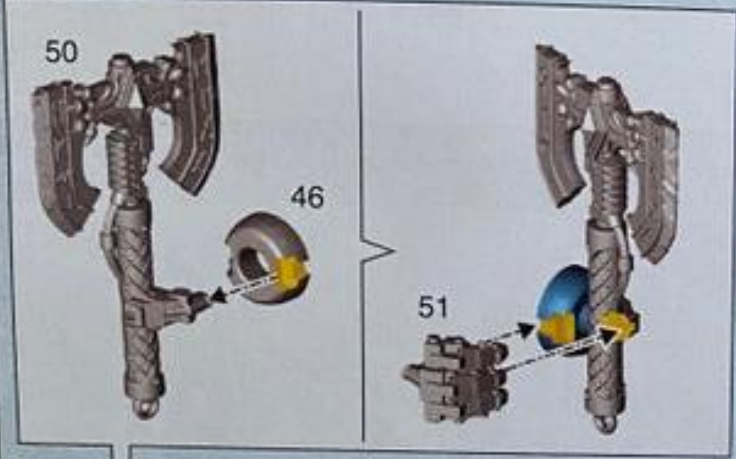



5 e

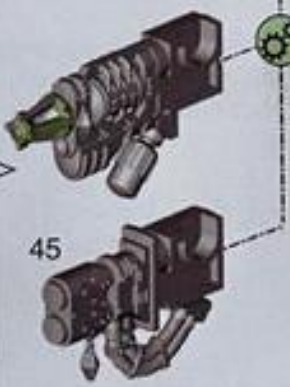
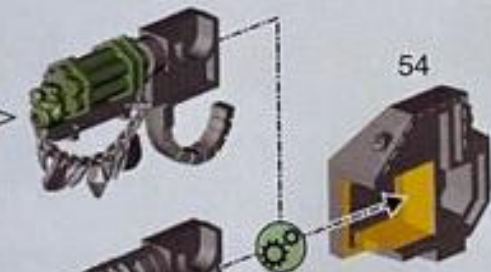
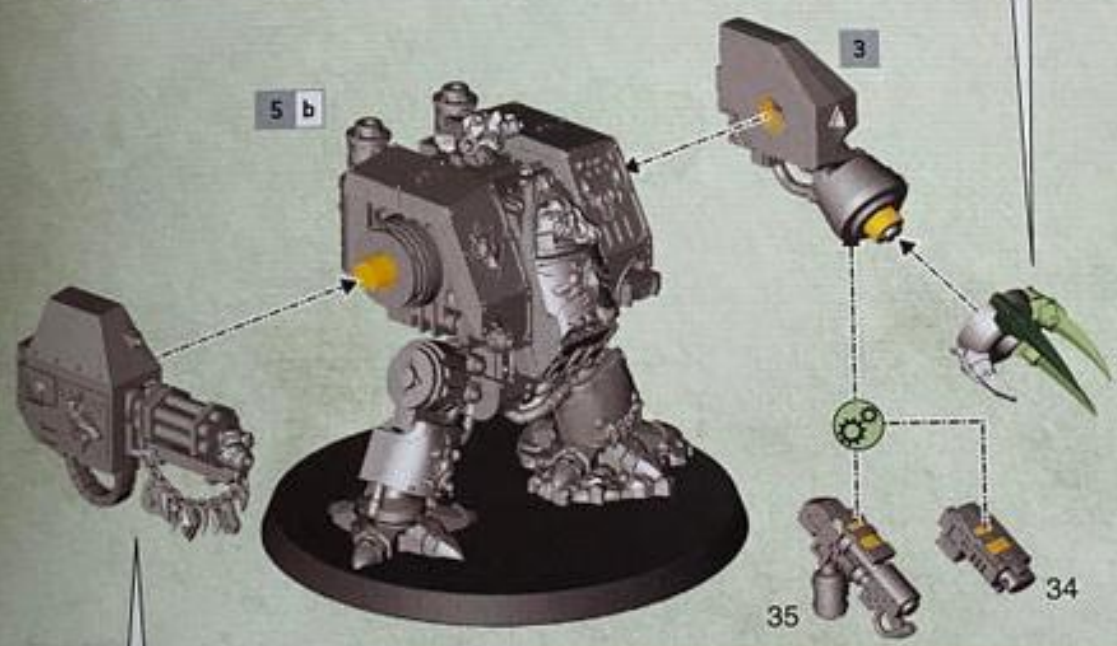
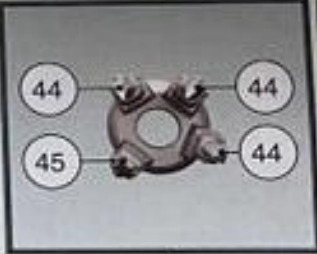
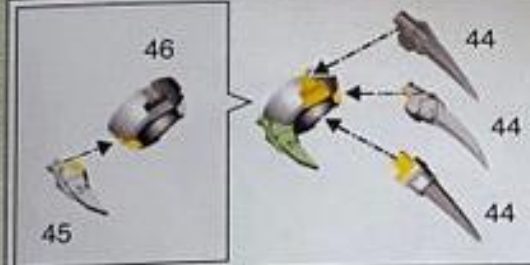



5 f



64



65



66



37



5 d/e

36



6

BJORN THE FELL-HANDED

BJORN MAIN TERRIBLE | BJORN GARRA IMPLACABLE | BJORN WOLFSKLAUE  
 BJORN DALLA MANO CRUDELE | 凶手ビョルン | 凶残比約恩

6 a

2

16



5

6



23



24





6 b



55



6 a

Ø 60mm

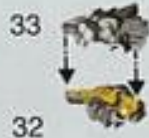

33

32

3

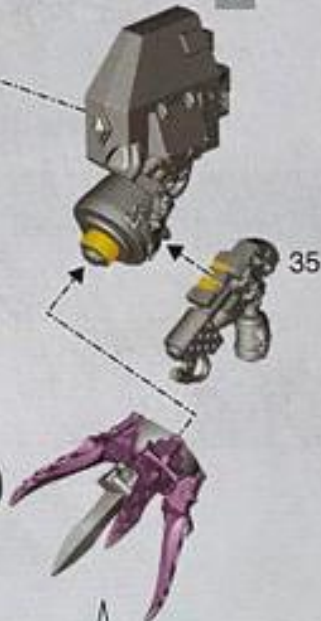

35



46

43



42

42

42

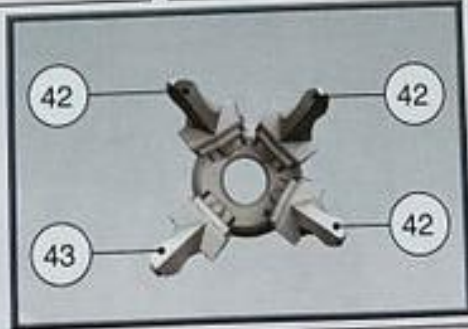

42

42

43

42



6 c

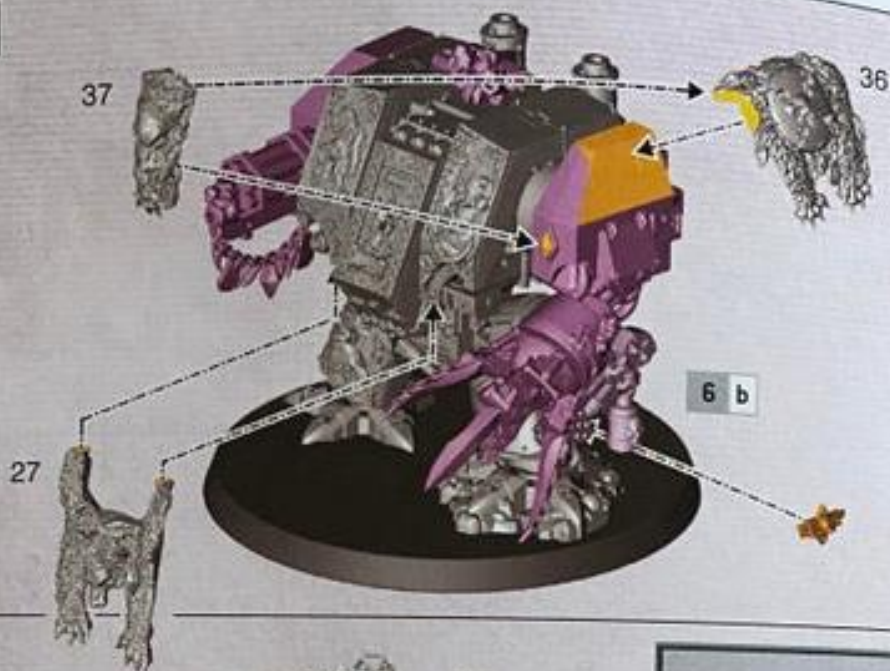

64



65



66



7

MURDERFANG

MEURTRECROC | COLMILLO ASESINO | TODESFANG | ZANNA ASSASSINA  
 マーダーファング | 杀戮牙

7 a

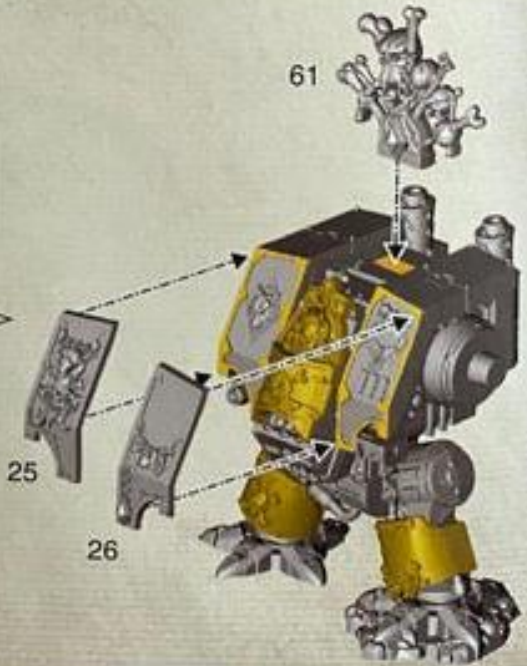
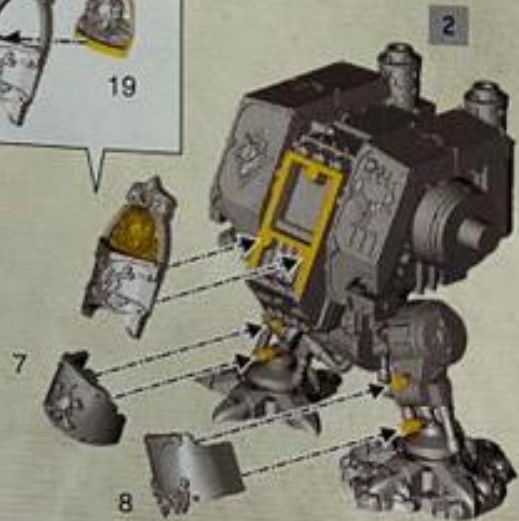



7 b

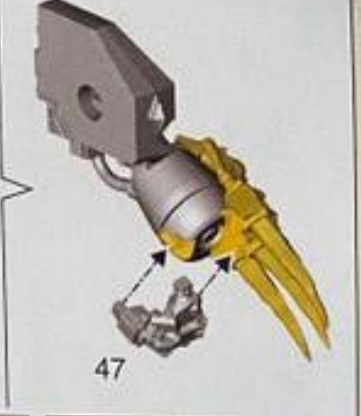
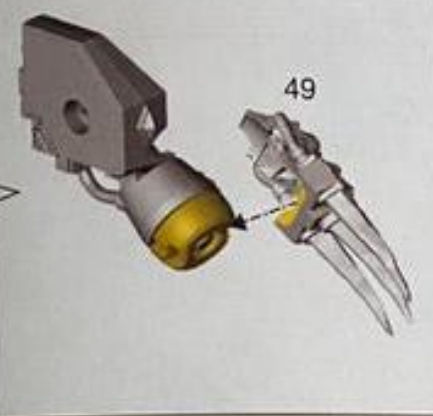

7 a



4

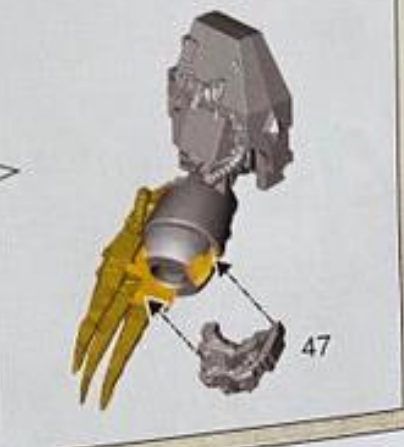
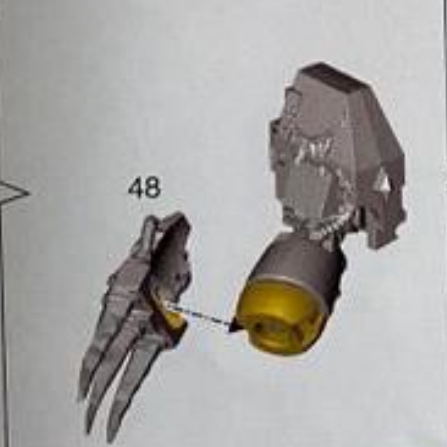



7 c



64



65



66



38



36

7 b



8

WULFEN DREADNOUGHT

DREADNOUGHT WULFEN  
WULFEN DREADNOUGHT

DREADNOUGHT WULFEN |  
ウルフエン・ドレッドノート

WULFEN-DREADNOUGHT  
狼人无畏机甲

8 a

17



19



2

7

8

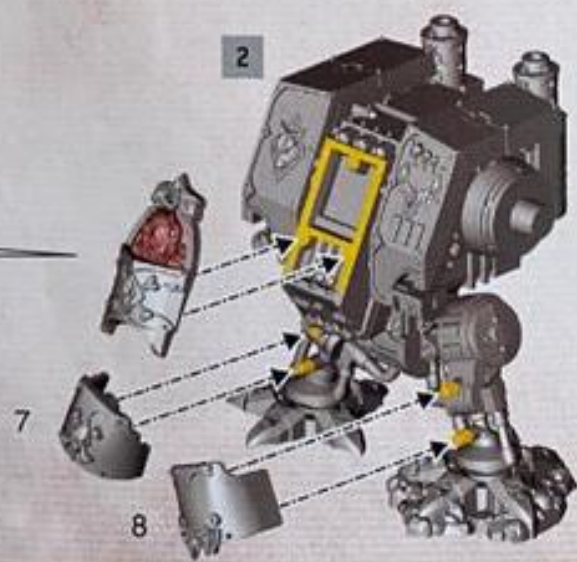

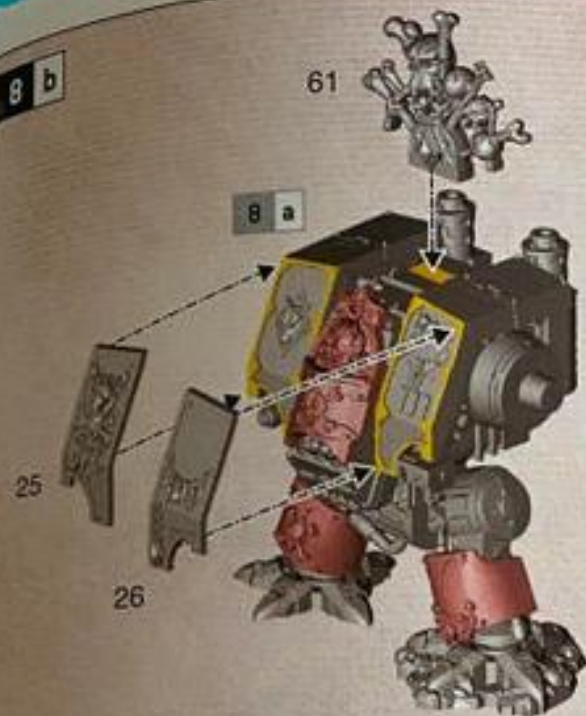
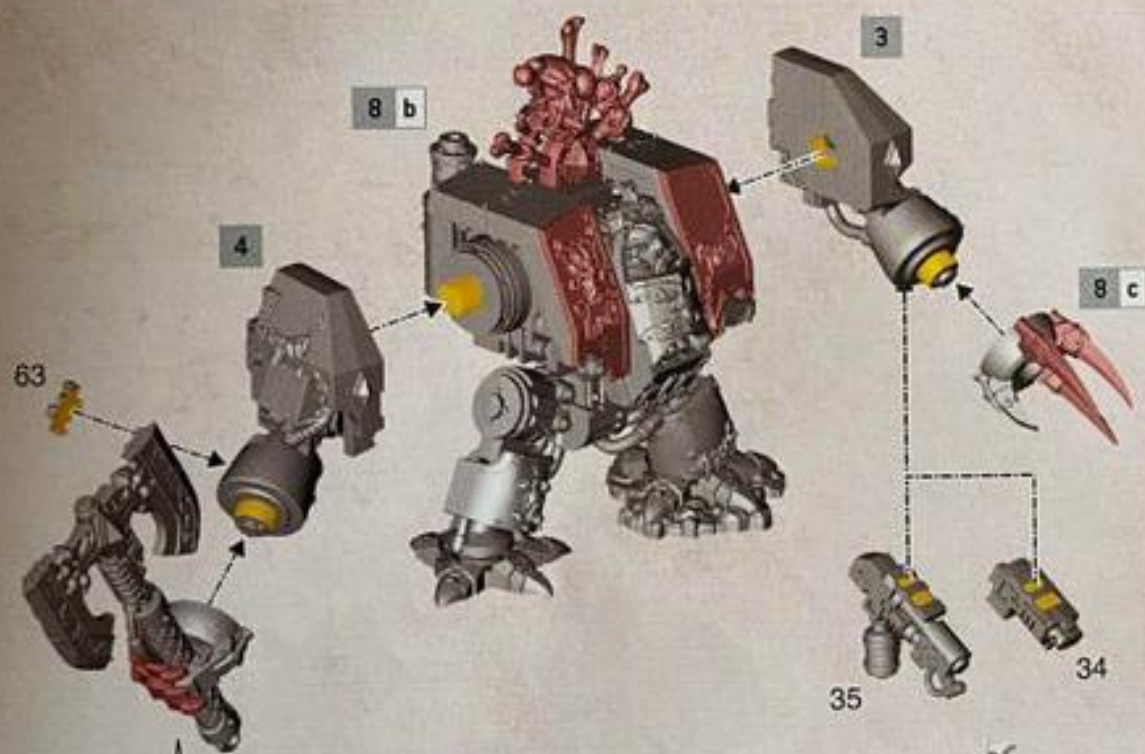

**8 b****8 c****8 d**



8 d



64



65



66



38

36

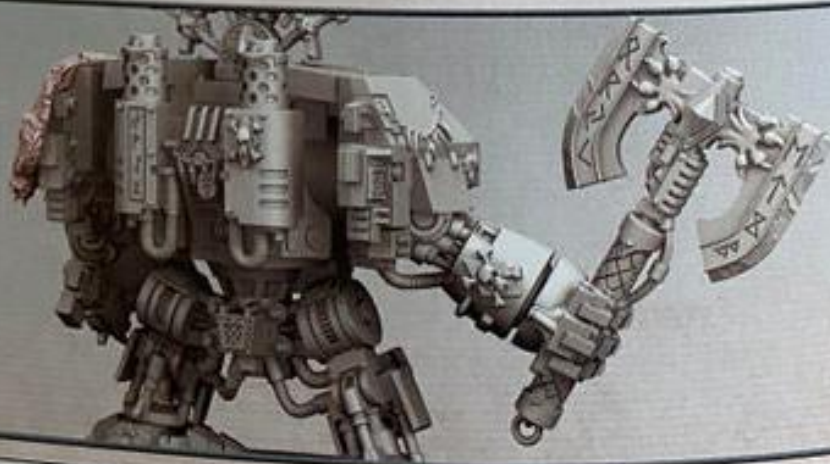



1017 Utilizzate le regole di base di Warhammer 40,000.com, le regole essenziali in basso ti aiuteranno a portare sul campo di battaglia la tua nuova unità. Per le regole complete di questa unità, consulta il Codex corrispondente alla tua armata.  
 1018 Consultez les règles de base de Warhammer 40,000.com, les règles essentielles ci-dessous vous permettront de jouer votre nouvelle unité sur le champ de bataille. Pour les règles complètes de cette unité, consultez le Codex correspondant à votre armée.  
 1019 Consulta las reglas de base de Warhammer 40,000.com, las siguientes reglas esenciales pondrán tu nueva unidad en el campo de batalla. Para ver las reglas completas de esta unidad, consulta el Codex de tu ejército.  
 1020 Wenn du die Regeln unten zusammen mit den Grundregeln von Warhammer 40,000.com verwendest, kannst du deine Einheit

1021 Utilizzate le regole di base che puoi trovare su Warhammer 40,000.com, le regole essenziali in basso ti aiuteranno a portare sul campo di battaglia la tua nuova unità. Per le regole complete di questa unità, consulta il Codex corrispondente alla tua armata.

1022 warhammer40000.comに掲載されているコアルールとともに以下のユニット用基本ルールを使用することで、このユニットを戦場に配備することができます。このユニットの完全版ルールについては、このユニットが属するアーミーのコーデックスを参照してください。

1023 下方的基本规则需搭配 Warhammer 40,000.com 上的《核心规则》使用，可助您将新单位部署到战场上。有关该单位的完整规则，请参见与您的军队相关的《圣典》。

## VENERABLE DREADNOUGHT

DREADNOUGHT VÉNÉRABLE | DREADNOUGHT VENERABLE | EHRWÜRDIGER DREADNOUGHT  
 DREADNOUGHT VENERABILE | ヴェネラブル・ドレッドノート | 神圣无畏机甲

Venerable Dreadnought



1	X	X	+4	-3	D3+3
2	X	X	☆	-3	1
3	24"	6	6	-1	1
4	X	X	+4	-2	3
5	24"	2	4	0	1
6	12"	06	5	-1	1

## BJORN THE FELL-HANDED

BJORN MAIN TERRIBLE | BJORN GARRA IMPLACABLE | BJÖRN WOLFSKLAUE  
 BJORN DALLA MANO CRUDELE | 凶手ビョルン | 凶残比约恩

Bjorn the Fell-Handed

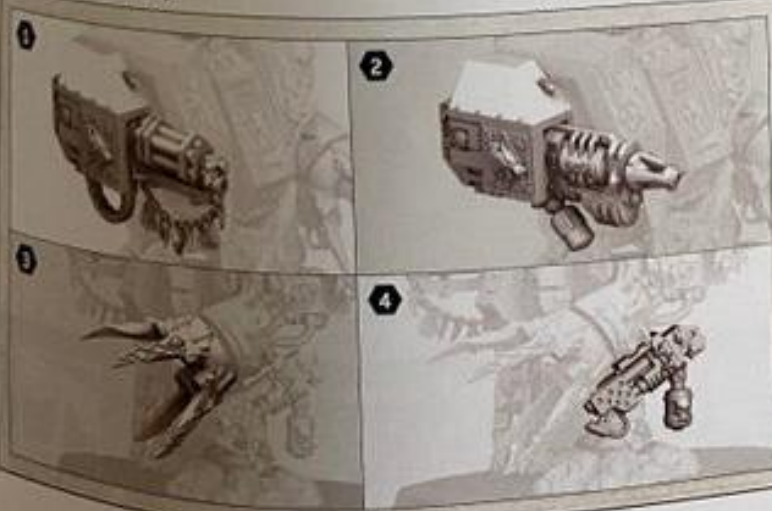

1	24"	6	6	-1	1
2	36"	03	6	-2	1
3	36"	1	8	-4	D3+3
4	X	X	+5	-4	D6
5	12"	06	5	-1	1



# MURDERFANG

MEURTRECROC

COLMILLO ASESINO

TODESFANG

ZANNA ASSASSINA

マールダーファンク

杀戮牙



Murderfang

8" 2+ 5+ 6 7 8 5 8 3+

1



2



3



1	X	X	x2	-3	3
2	24"	2	4	0	1
3	12"	D6	5	-1	1

# WULFEN DREADNOUGHT

DREADNOUGHT WULFEN  
WULFEN DREADNOUGHT

DREADNOUGHT WULFEN  
ウルフェン・ドレッドノート

WULFEN-DREADNOUGHT  
狼人无畏机甲



Wulfen Dreadnought

8" 3+ 5+ 6 7 8 4 7 3+

1



2



3



4



1	X	X	+4	-3	03+3
	X	X	★	-3	1
2	X	X	+4	-2	3
3	24"	2	4	0	1
4	12"	D6	5	-1	1



993201011541



warhammer.com

Games Workshop Limited, Willow Road,  
Nottingham, NG7 2WS, UK

© Copyright Games Workshop Limited 2020.

