



Free Downloads of Build Instructions,
Assembly Booklets & How To Guides

BuildInstructions.com

CHOOSE THE VARIANT YOU WANT TO BUILD • CHOISISSEZ LA VARIANTE À ASSEMBLER • ELIGE QUÉ VERSIÓN QUERES MONTAR
 WÄHLE DIE VARIANTE, DIE DU BAUEN MÖCHTEST • SCEGLI LA VARIANTE CHE VUOI ASSEMBLARE • 組み立てたい方のミニチュアを選択する

LONG FANGS

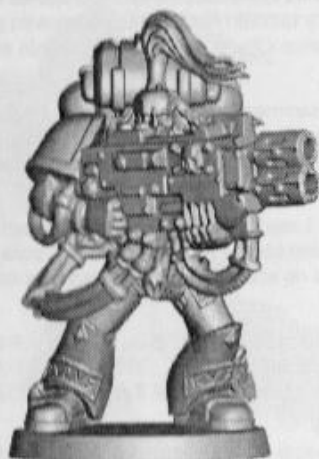
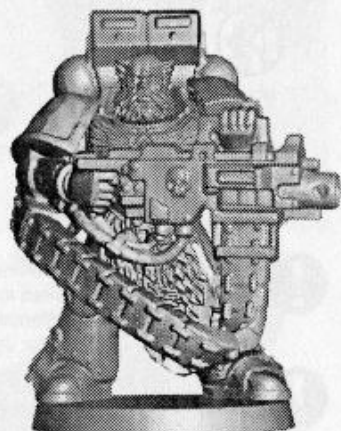
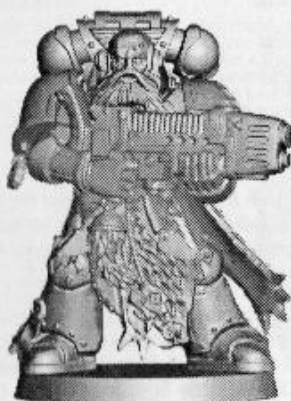

WOLF GUARD PACK LEADER

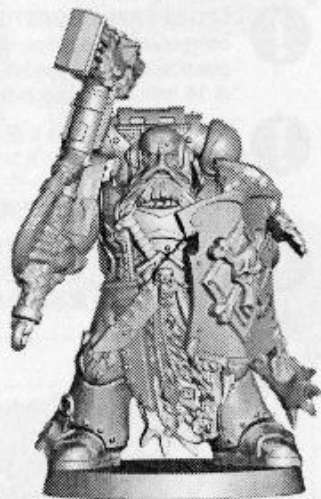

STEPS
ÉTAPES
PASOS
SCHITTE
FASI
ステップ

1 - 11

STEPS • ÉTAPES • PASOS
SCHITTE • FASI • ステップ

12 - 13

	WS	BS	S	T	W	I	A	Ld	Sv	Unit Type	Unit Composition
Long Fang	4	4	4	4	1	4	1	9	3+	Infantry	1 Long Fang
Long Fang Ancient	4	4	4	4	1	4	2	9	3+	Infantry (Character)	1 Long Fang Ancient
Wolf Guard Pack Leader	4	4	4	4	1	4	2	9	3+	Infantry (Character)	

EXPLANATION OF SYMBOLS • EXPLICATION DES SYMBOLES • EXPLICACIÓN DE SÍMBOLOS
ERLÄUTERUNG DER SYMBOLE • LEGENDA DEI SIMBOLI • アイコンの説明 • 符号说明



SPECIAL INSTRUCTION - PLEASE READ
INSTRUCTIONS SPECIALES - LIRE ATTENTIVEMENT
INSTRUCCIÓN ESPECIAL - POR FAVOR, LÉALA
BESONDERE ANWEISUNG - BITTE LESEN
ISTRUZIONI SPECIALI - LEGGI ATTENTAMENTE
特別事項 - 必ず読んでください
特別説明 - 請阅读



STAGE COMPLETE
ÉTAPE TERMINÉE
PASO COMPLETADO
SCHRITT ABGESCHLOSSEN
FASE COMPLETA
このステップの完成例
阶段完成



CHOICE OF PARTS
CHOIX D'ÉLÉMENTS
MODELS DE COMPONENTES
AUSWAHL AN TEILEN
SCELTA DI COMPONENTI
パーツの選択
部件选择



PAINT BEFORE ASSEMBLY
PEINDRE AVANT ASSEMBLAGE
PINTAR ANTES DEL MONTAJE
ERST BEMALEN, DANN ZUSAMMENBauen
DIPINGI PRIMA DELL'ASSEMBLAGGIO
組み立て前にペイントすること
組裝前請先塗裝



DRY FIT STAGE BEFORE GLUING
TESTER AVANT DE COLLER
COMPROBAR EL ENGAJE ANTES DE PEGAR
POSITIONIERUNG ERST OHNE KLEBSTOFF AUSPROBIEREN
PRIMA A SFODCO PRIMA DI INCOLLARE
接合前に仮組みすること
涂胶前先测试



ALTERNATE VIEW
AUTRE ANGLE DE VUE
VISTA ALTERNATIVA
ALTERNATIVE ANSICHT
VISUALE ALTERNATIVA
別の角度から見た図
其他視角



REPEAT PROCESS
RÉPÉTER L'ÉTAPE
REPETIR PASOS
WIEDERHOLEN DEN VORGANG
REPETI IL PROCESSO
この手順を繰り返すこと
重复过程



DO NOT GLUE THE COMPONENTS
NE PAS COLLER LES ÉLÉMENTS
NO PEGAR LOS COMPONENTES
BITTE DIE TEILE NICHT KLEBEN
NON INCOLLARE I COMPONENTI
パーツを接着しないこと
請勿粘貼部件



READ THIS FIRST: Before assembling your model kit please read through the instructions in this booklet carefully. A pair of plastic cutters is required to remove the plastic components in this kit from their frame. To assemble your model you will need plastic glue. Games Workshop sells Citadel Plastic Cutters and Citadel Plastic Glue, but does not recommend these products for use by children under the age of 16 without adult supervision.



À LIRE EN PREMIER : Avant de vous lancer dans l'assemblage de ce kit, veuillez lire attentivement les instructions de ce livret. Une pince coupante pour plastique est nécessaire pour détacher chaque élément de sa grappe. Vous aurez également besoin de colle plastique. Les lignes de moulage peuvent être retirées avec un couteau de modélisme. Games Workshop commercialise des Pincés Coupantes Citadel et de la colle plastique Citadel, mais n'en recommande pas l'usage pour les enfants de moins de 16 ans sans la supervision d'un adulte.



LEER ANTES DE MONTAR: Antes de montar el contenido del kit, lee estas instrucciones cuidadosamente. Para montar este kit te harán falta unas Tenazas Citadel para separar las piezas de la matriz de plástico y también necesitarás pegamento para plástico. Games Workshop vende herramientas de modelismo y pegamento para plástico Citadel, pero no recomienda estos productos a menores de 16 años sin la supervisión de un adulto.



LIES DIES ZUERST: Bitte lies diese Anleitung sorgfältig, bevor du mit dem Zusammenbau deiner Miniatur beginnst. Du benötigst einen Kunststoffseitenschneider, um die Kunststoffbauteile aus dem Gussrahmen herauszutrennen, und Kunststoffkleber, um die Miniatur zusammenzubauen. Games Workshop bietet Citadel-Kunststoffseitenschneider und Citadel-Kunststoffkleber an, empfiehlt aber, dass Kinder unter 16 Jahren diese nur unter Aufsicht eines Erwachsenen benutzen.



LEGGI PRIMA QUESTO: leggi attentamente queste istruzioni prima di assemblare i modelli. Per rimuovere dallo sprue i componenti di plastica di questo kit sono necessarie un paio di tronchesine. Per assemblare i modelli occorre la colla per plastica. Games Workshop vende Tronchesine Citadel e Colla per plastica Citadel, ma ne sconsiglia l'uso da parte dei minori di 16 anni senza la supervisione di un adulto.



組み立て前にお読みください: ミニチュアを組み立てる前に、この組み立て説明書をよく読んでください。このキットに含まれるプラパーツをランナーから切り出すには、ニッパーが必要です。ミニチュアを組み立てるには、プラ用セメントが必要です。ゲームワークショップは、シタデル・ニッパーとシタデル・プラ用セメントを販売していますが、保護者の監督なしに16歳未満のお子様これらの製品を使用することを推奨していません。



首先阅读: 在组装您的整套模型之前, 请仔细阅读本手册中的说明。如想将本套模型中的塑料部件从框架上剪下来, 您需要使用塑料剪钳。在组装模型时您需要塑料胶水, Games Workshop出售Citadel塑料剪钳和Citadel塑料胶水, 但建议16岁以下儿童在成人监护下使用这些产品。



CITADEL PLASTIC GLUE THICK
COLLE PLASTIQUE ÉPAISSE CITADEL
PEGAMENTO PARA PLÁSTICO ESPESO
CITADEL-KUNSTSTOFFKLEBER (DICKFLÜSSIG)
COLLA PER PLASTICA Densa CITADEL
シタデル・プラ用セメント (濃厚タイプ)
CITADEL 塑料稠胶



CITADEL PLASTIC GLUE THIN
COLLE PLASTIQUE LIQUIDE CITADEL
PEGAMENTO PARA PLÁSTICO FLUIDO
CITADEL-KUNSTSTOFFKLEBER (DÜNNFLÜSSIG)
COLLA PER PLASTICA FLUIDA CITADEL
シタデル・プラ用セメント (流し込みタイプ)
CITADEL 塑料薄胶



CITADEL PLASTIC CUTTERS
PINCES COUPANTES POUR PLASTIQUE CITADEL
TENAZAS CITADEL
CITADEL-KUNSTSTOFFSEITENSCHNEIDER
TRONCHESINE CITADEL
シタデル・ニッパー
CITADEL 塑料剪钳

1 LONG FANG ANCIENT
LONG FANG ANZIANO

A

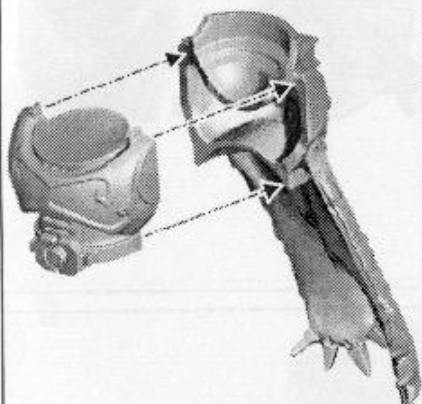

B

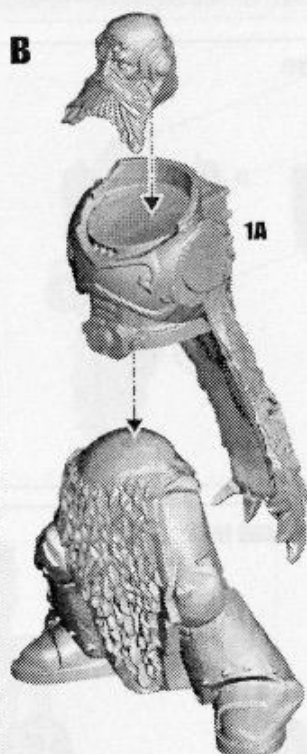

C

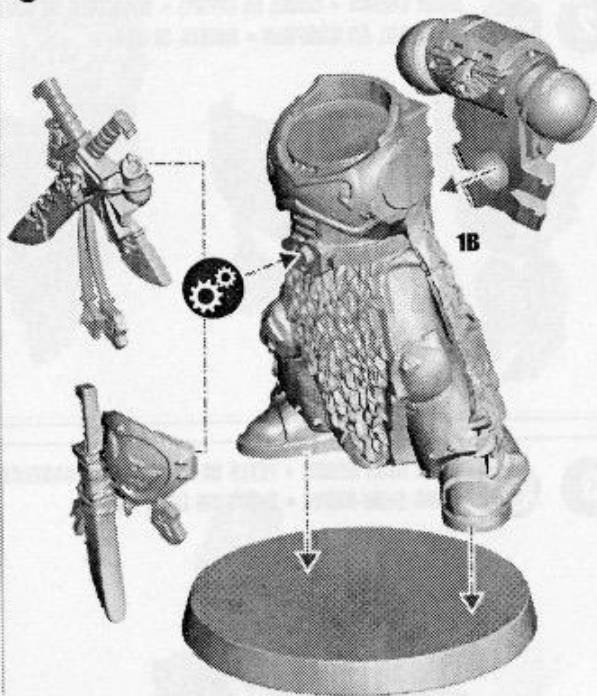

D



Bolt Pistol
Pistolets bolters
Pistola bølter
Boltpistoie
Pistola requiem

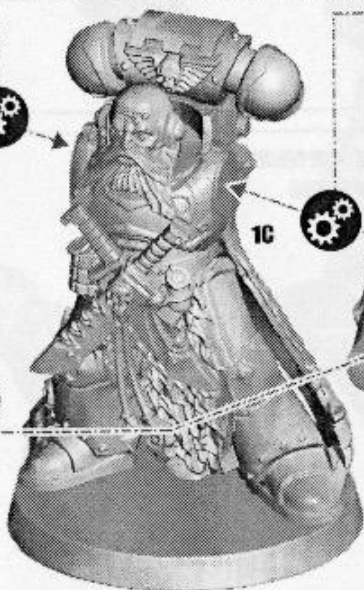

Chainsword
Épées tronçonneuses
Espada sierra
Kettenschwert
Spada a catena

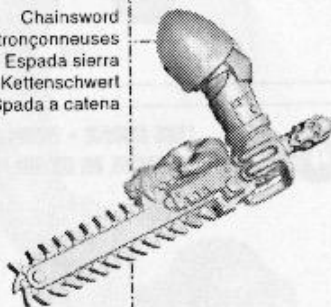

Power Fist
Gantelet énergétique
Puño de combate
Energiefaust
Maglio potenziato

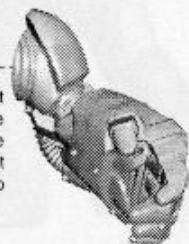

Plasma Pistol
Pistolets à plasma
Pistolas de plasma
Plasmapistoie
Pistole plasma

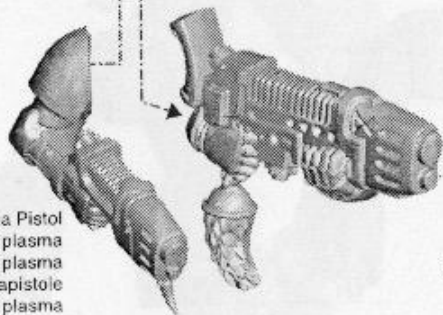

E





Follow steps 2 - 6 for all variants • Suivre l'étape 2 - 6 pour toutes les variantes • Sigue el paso 2 - 6 para todas las variantes
 Folge Schritten 2 - 6 für alle Varianten • Segui le fasi 2 - 6 per tutte le varianti

2



BODY CHOICE • CHOIX DE CORPS • OPCIONES DE CUERPO
AUSWAHL AN KÖRPERN • SCELTA DI CORPI

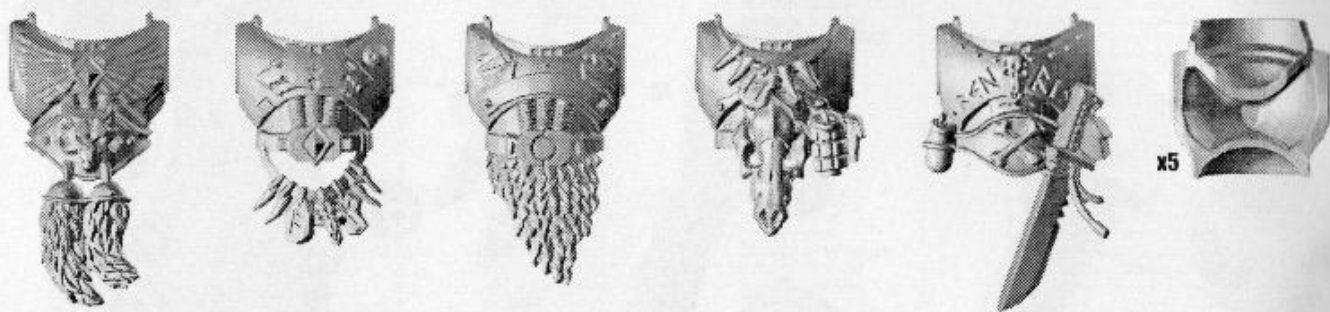

3



LONG FANG HEADS • TÊTES DE LONG FANG • CABEZAS DE LONG FANG
LONG-FANG-KÖPFE • TESTE DEI LONG FANGS



4



LEGS CHOICE • CHOIX DE JAMBES • OPCIONES DE PIERNAS
AUSWAHL AN BEINEN • SCELTA DI GAMBE

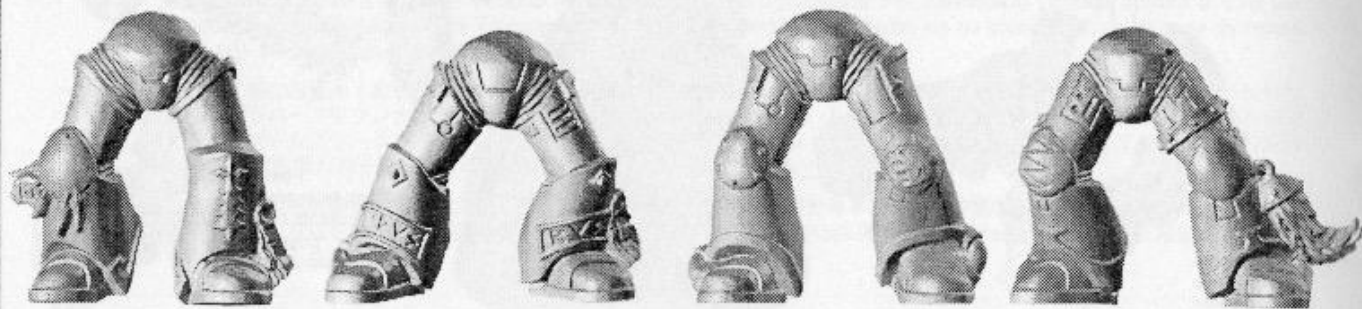

5



SHOULDER PAD CHOICE • CHOIX D'ÉPAULIÈRES • OPCIONES DE HOMBRENAS
AUSWAHL AN SCHULTERPANZERN • SCELTA DI SPALLACCI

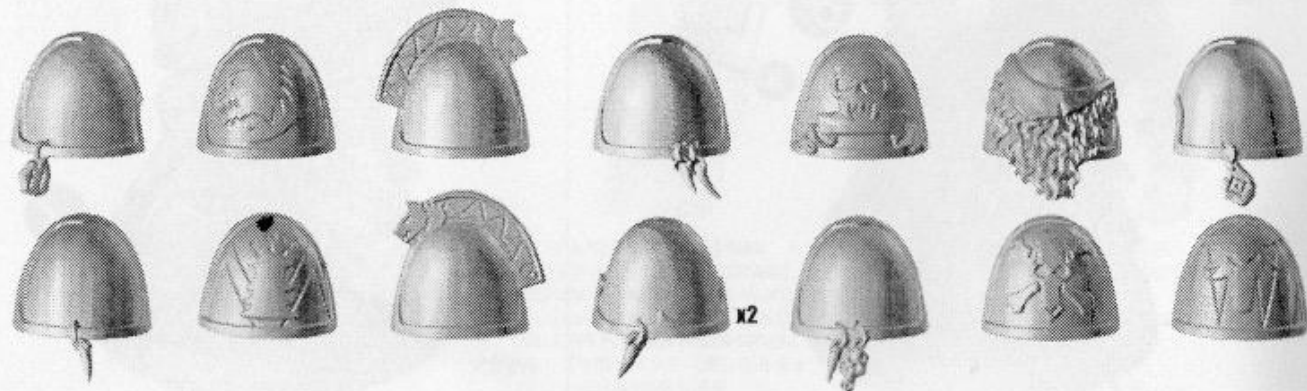

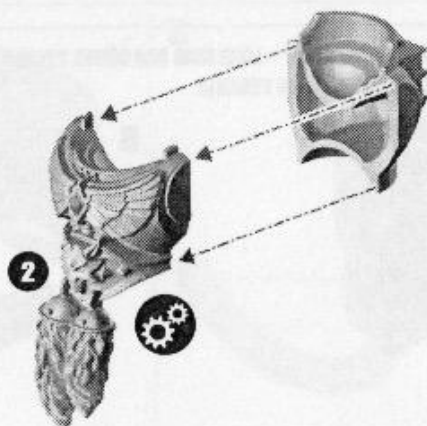
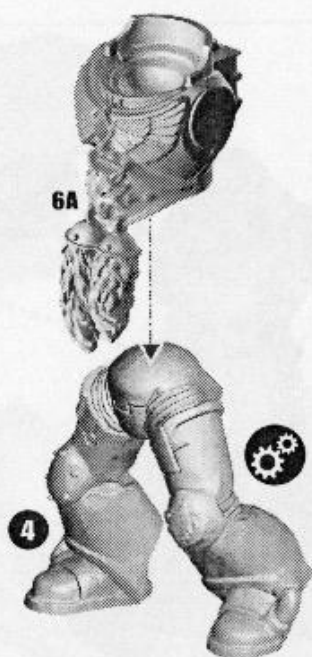
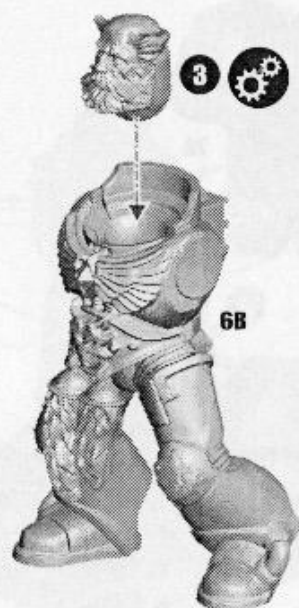
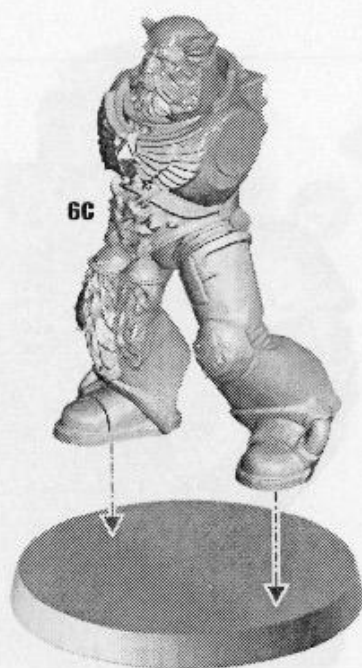
6**GENERIC TORSO ASSEMBLY • ASSEMBLAGE DU TORSO • MONTAJE DE TORSO GENÉRICO
BEISPIEL FÜR TYPISCHEN TORSO-ZUSAMMENBAU • ASSEMBLAGGIO DEL TORSO GENERICO • 一般的な胴体の組み立て****A****X4****B****C****D****E**



Choose 4 of the following variants to build • Choisissez 4 de ces variantes à assembler • Elige 4 variantes de las siguientes
Wähle 4 der folgenden Varianten • Scegli 4 delle seguenti varianti

7

LONG FANG WITH HEAVY BOLTER • LONG FANG AVEC BOLTER LOURD • LONG FANG CON BÓLTER PESADO
LONG FANG MIT SCHWEREM BOLTER • LONG FANG CON REQUIEM PESANTE

A

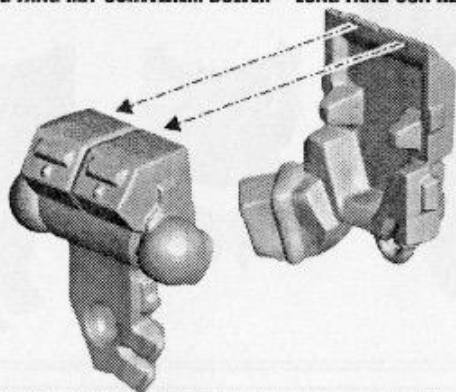

B

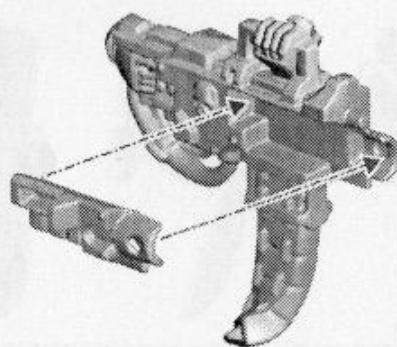

C

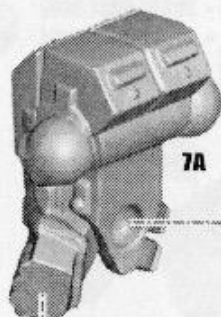

7A



6

D

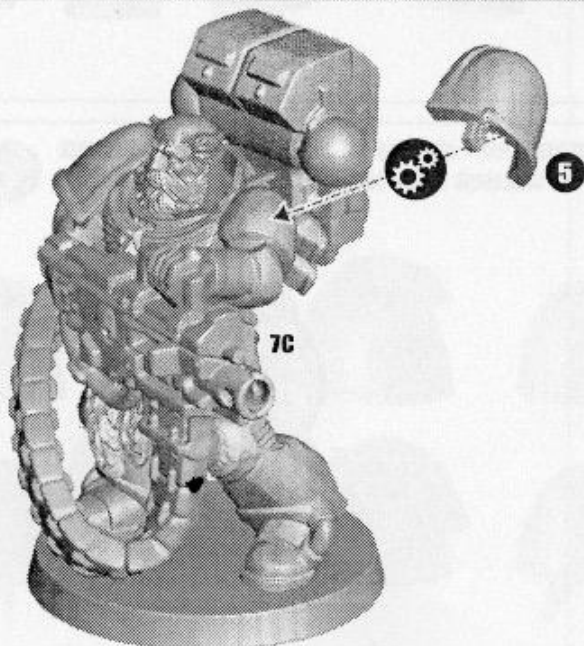

7C

5

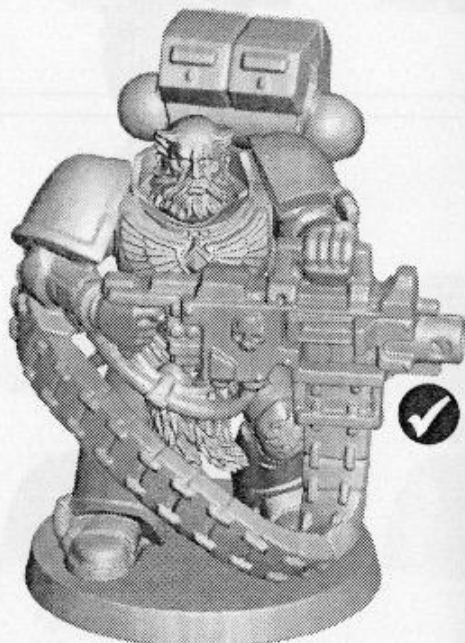

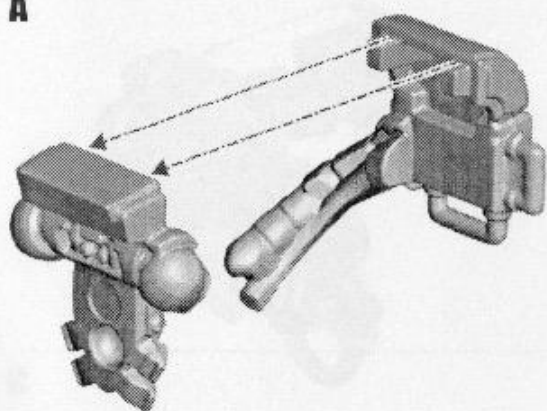
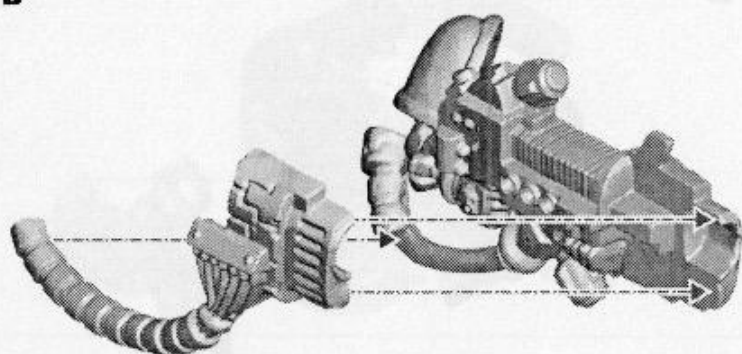
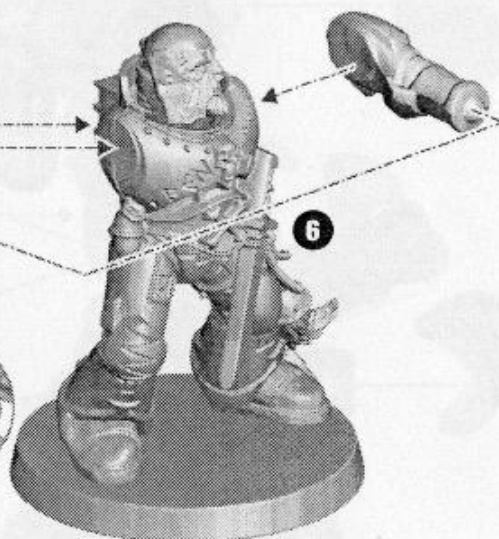
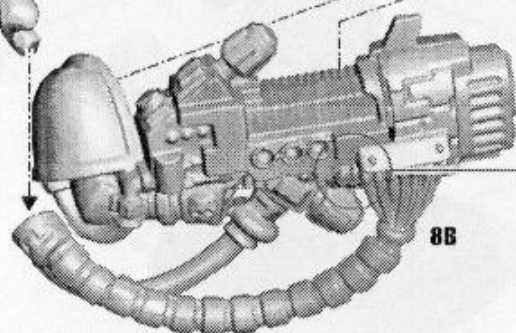
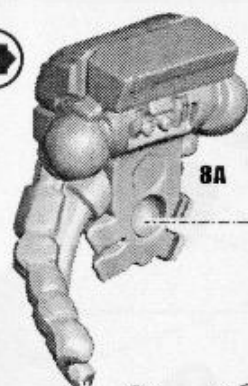
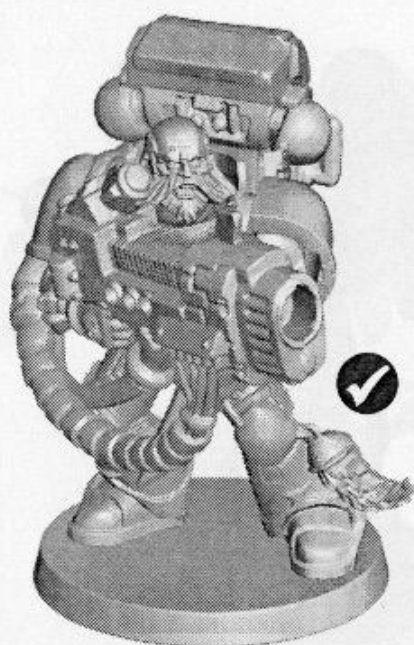
8**LONG FANG WITH PLASMA CANNON • LONG FANG AVEC CANON À PLASMA • LONG FANG CON CAÑÓN DE PLASMA
LONG FANG MIT PLASMAKANONE • LONG FANG CON CANNONE PLASMA****A****B****C****D**

9

LONG FANG WITH MISSILE LAUNCHER • LONG FANG AVEC LANCE-MISSILES • LONG FANG CON LANZAMISILES
LONG FANG MIT RAKETENWERFER • LONG FANG CON LANCIAMISILI

A

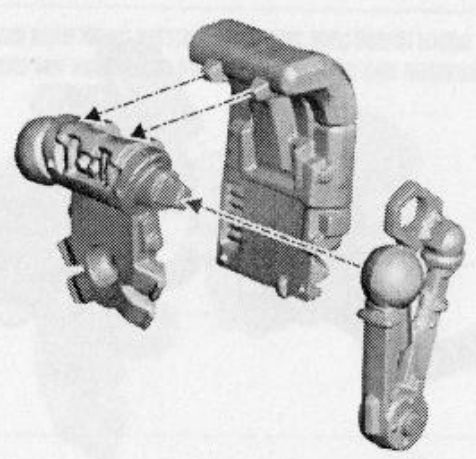

B

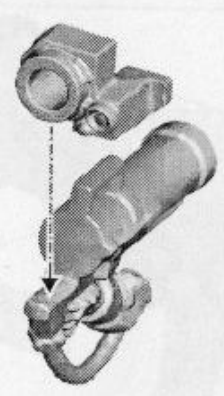

C

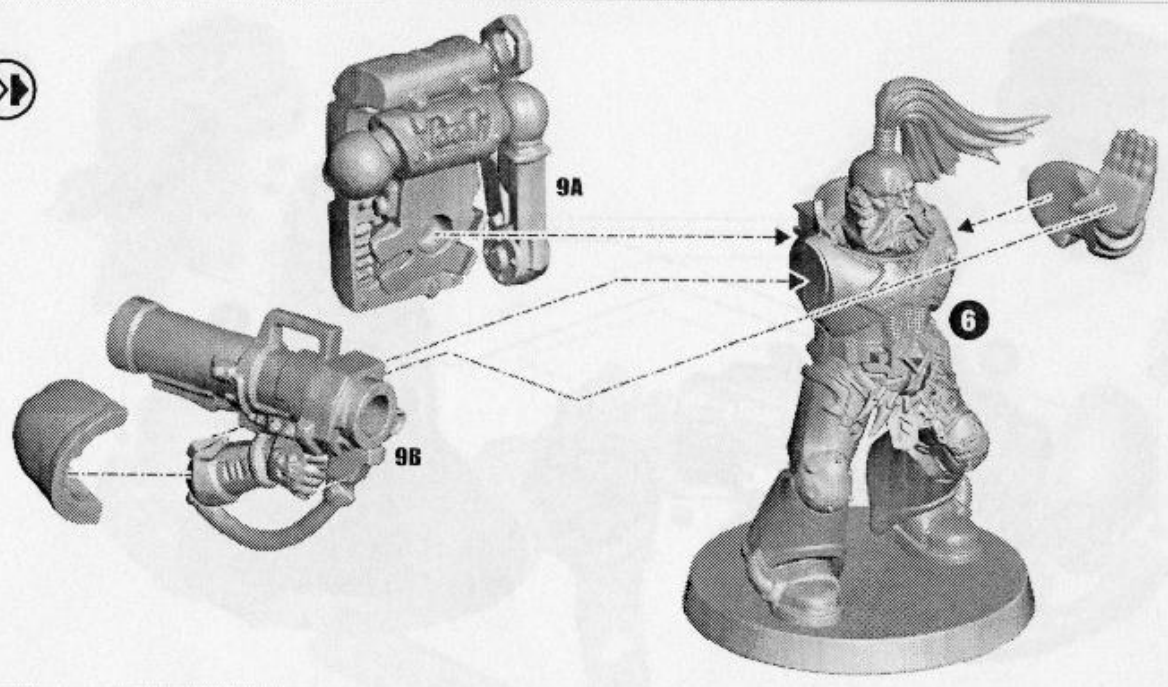

D



10

LONG FANG WITH LAS CANNON • LONG FANG AVEC CANON LASER • LONG FANG CON CAÑÓN LÁSER
 LONG FANG MIT LASERKANONE • LONG FANG CON CANNONE LASER

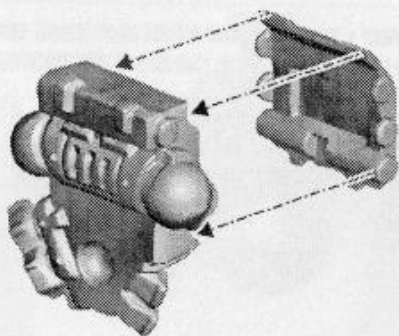
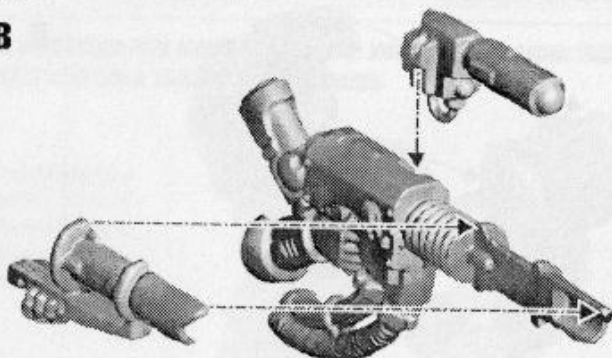
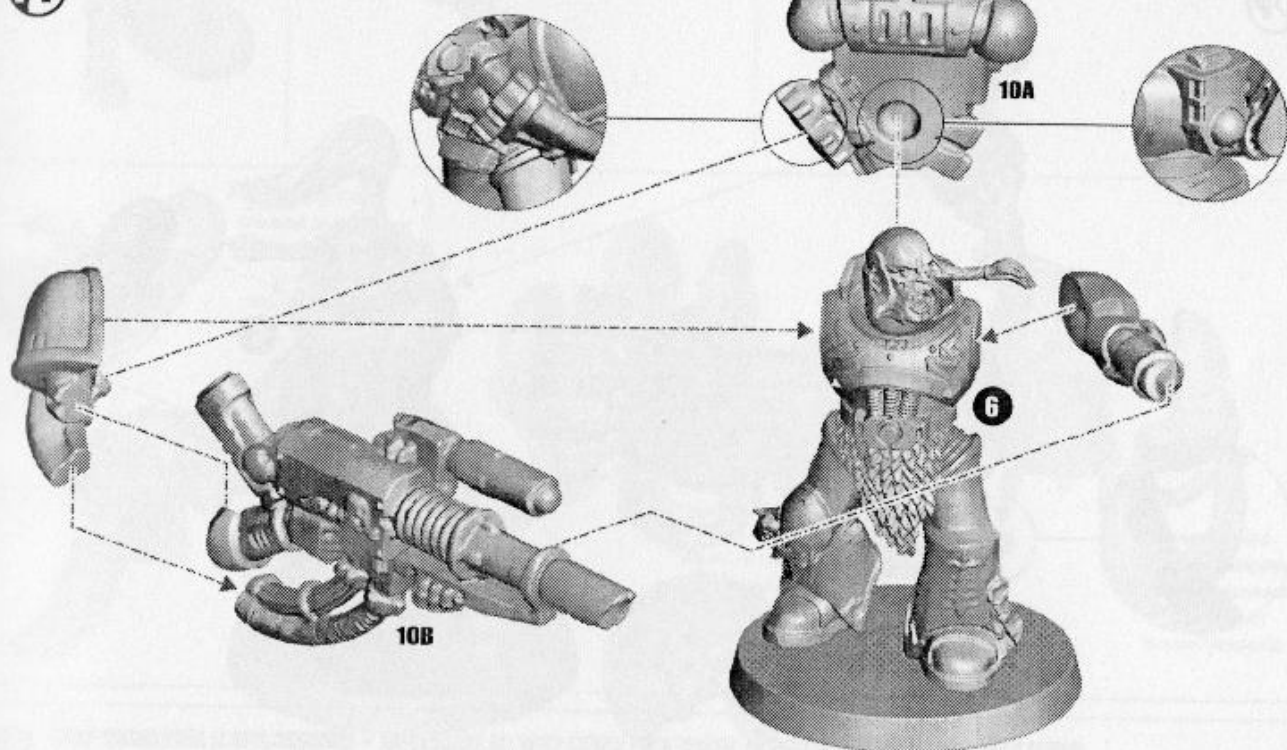
A**B****C****D**

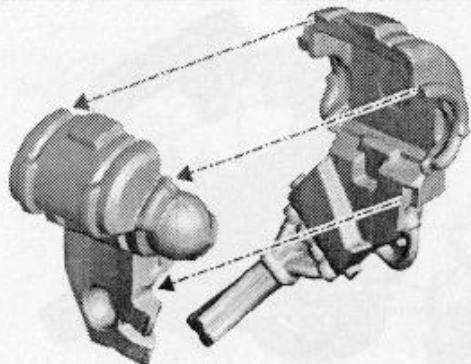
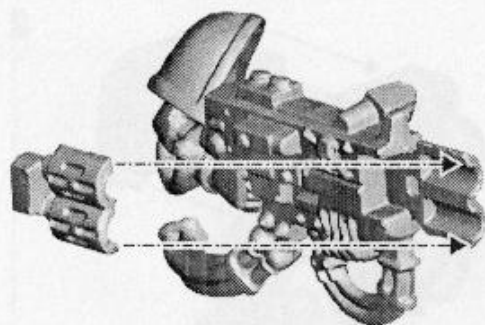
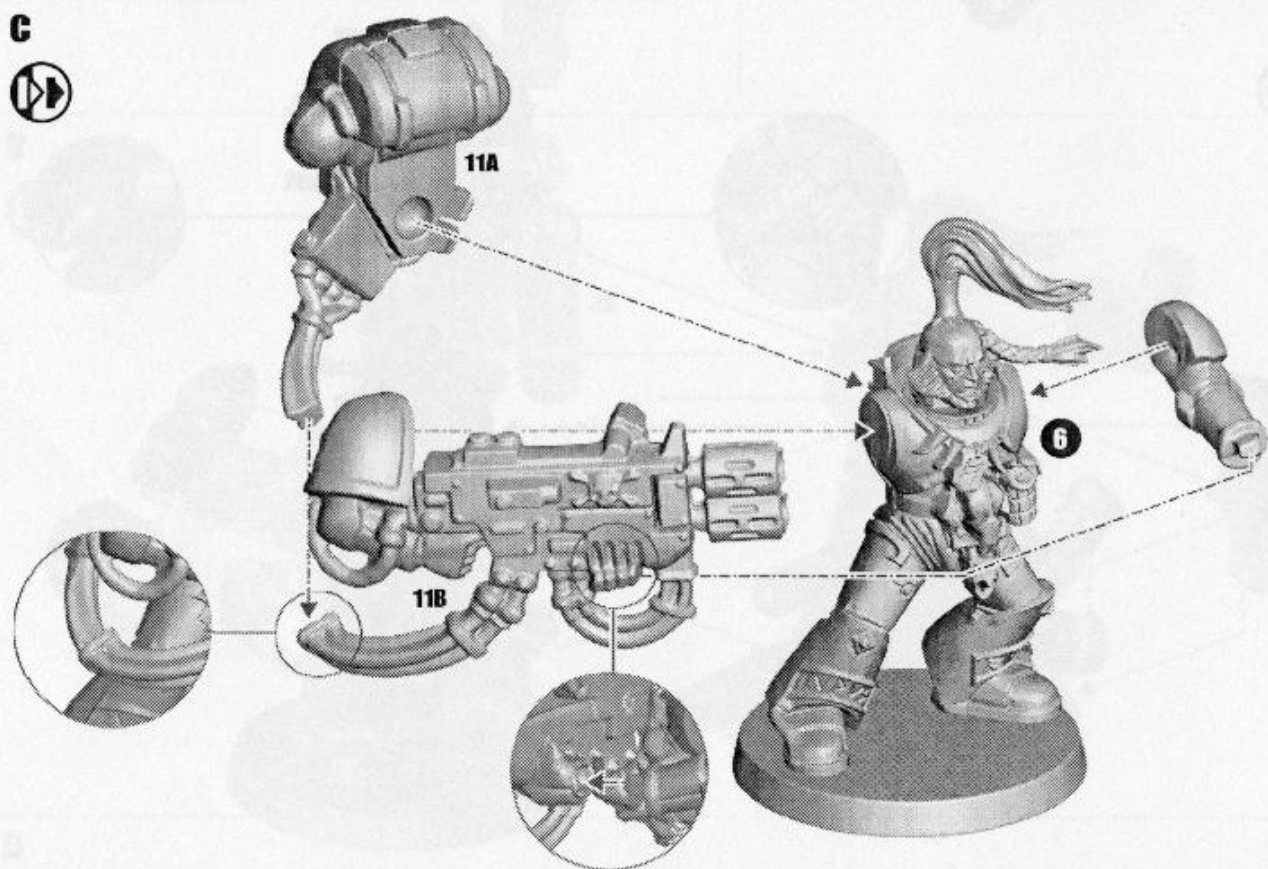
11**LONG FANG WITH MULTI MELTA • LONG FANG AVEC MULTI-FUSEUR • LONG FANG CON CAÑÓN DE FUSIÓN
LONG FANG MIT MULTIMELTER • LONG FANG CON MULTITERMICO****A****B****C****D**

**12 WOLF GUARD PACK LEADER WEAPON CHOICE • CHOIX D'ARMES DU WOLF GUARD PACK LEADER • OPCIONES DE ARMAS DEL WOLF GUARD PACK LEADER
WAFFENOPTIONEN FÜR DEN WOLF GUARD PACK LEADER • SCELTA D'ARMI DELLA WOLF GUARD PACK LEADER**

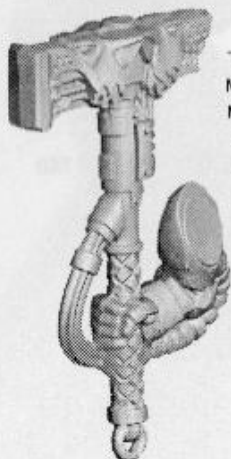

Frost Sword
Espée de Givre
Espada gélida
Frostschwert
Spada del gelo

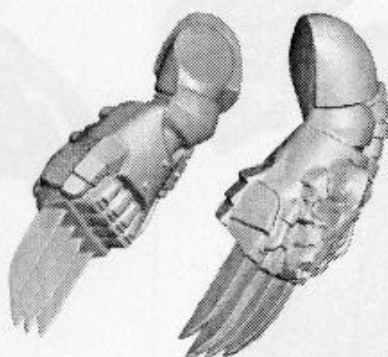

Thunder Hammer
Marteau Tonnerre
Martillo de trueno
Energiehammer
Martello Tuono

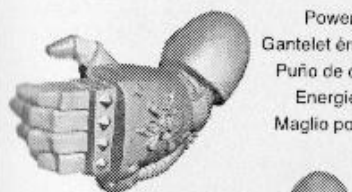

Wolf claws
Griffes de loup
Garras de lobo
Wolfsklauen
Artigli del lupo



Power Fist
Gantelet énergétique
Puño de combate
Energiefaust
Maglio potenziato

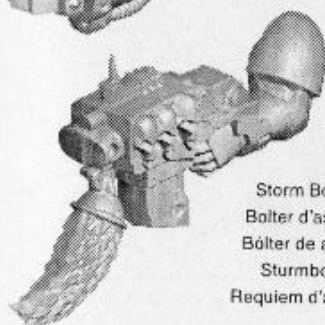

Storm Bolter
Bolter d'assaut
Bólter de asalto
Sturmbolter
Requiem d'assalto

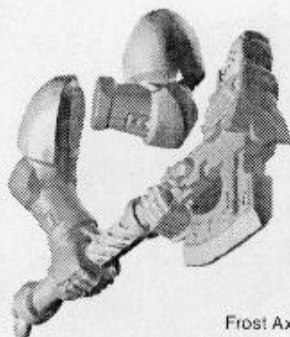

Frost Axe
Hache de Givre
Hacha gélida
Frostaxt
Ascia del gelo

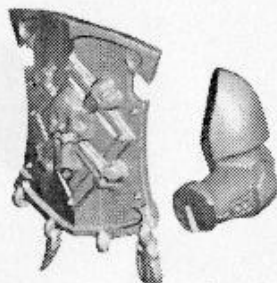

Storm Shield
Bouclier Tempête
Escudo de tormenta
Sturmschild
Scudo Tempesta

**13 WOLF GUARD PACK LEADER ASSEMBLY • ASSEMBLAGE DU WOLF GUARD PACK LEADER • MONTAJE DEL WOLF GUARD PACK LEADER
ZUSAMMENBAU DES WOLF GUARD PACK LEADERS • ASSEMBLAGGIO DELLA WOLF GUARD PACK LEADER**

A

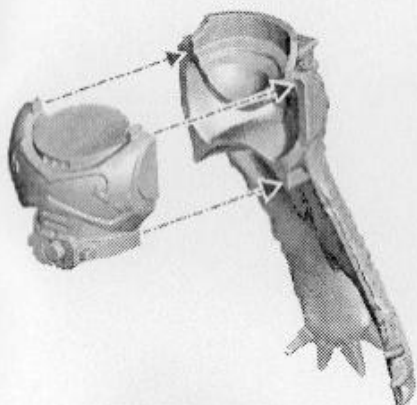

B



13A

C

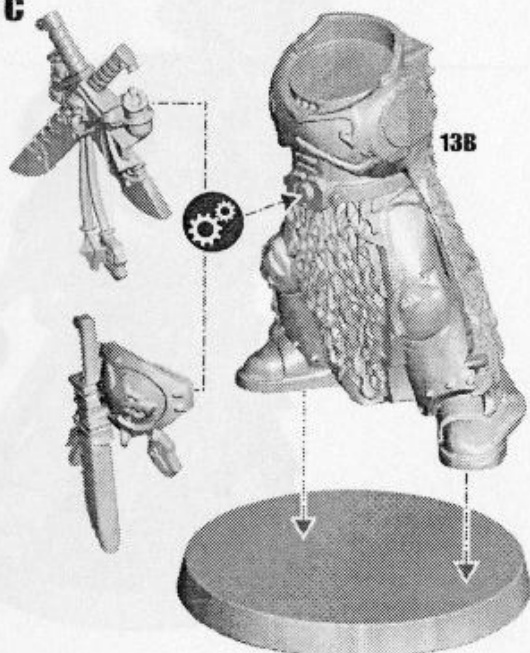

13B

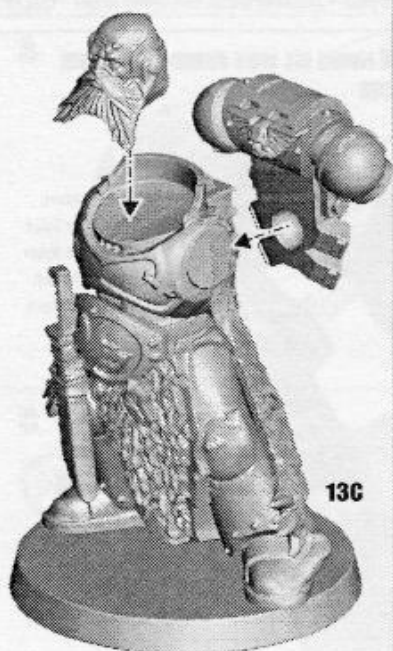
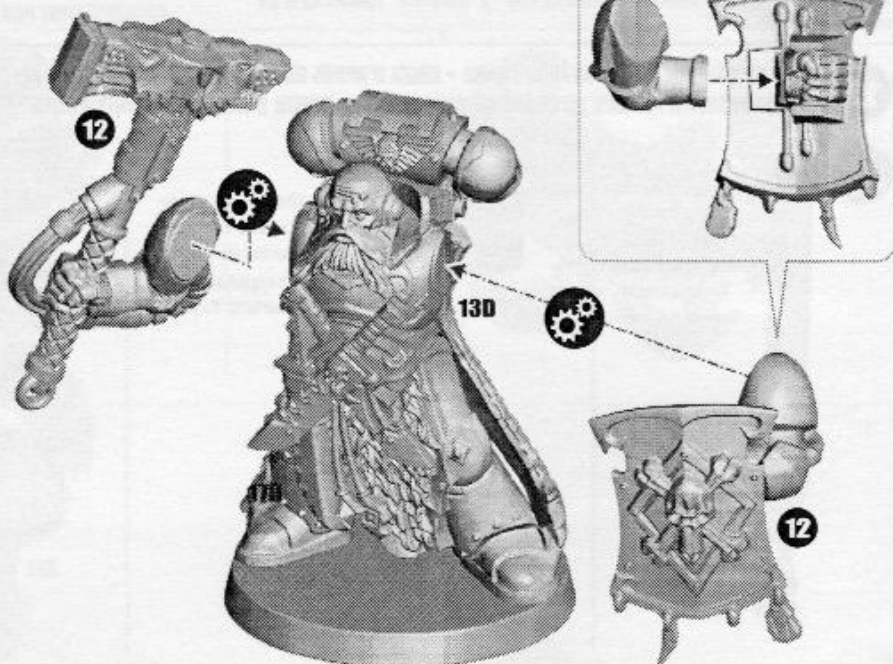
D**E****F**