



Free Downloads of Build Instructions,  
Assembly Booklets & How To Guides

**BuildInstructions.com**

# WARHAMMER 40,000

# COMBAT PATROL



## SPACE WOLVES

PATROUILLE | PATRULLA DE LOBOS ESPACIALES | KAMPFPATROUILLE | PATTUGLIA DA COMBATTIMENTO | コンバットパトロール:スペースウルフ | 战斗巡逻队太空野狼

**!** READ THIS FIRST | À LIRE EN PRIORITÉ | BITTE BEACHTEN | LEE ESTO PRIMERO | LEGGI PRIMA QUESTO | 最初にお読みください。 | 请优先阅读

**ENG** BEFORE ASSEMBLING YOUR MINIATURES, PLEASE READ THROUGH THE INSTRUCTIONS IN THIS BOOKLET CAREFULLY. A pair of plastic cutters is required to remove the plastic components in this kit from their frame. We advise using a mouldline scraping tool to clean up the parts. To assemble your model you will need plastic glue. Games Workshop sells Citadel Fine Detail Cutters, Citadel Mouldline Remover and Citadel Plastic Glue, but does not recommend these products for use by children under the age of 16 without adult supervision.

**FRE** AVANT D'ASSEMBLER VOS FIGURINES, VEUILLEZ LIRE ATTENTIVEMENT LES INSTRUCTIONS DE CE LIVRET. Une pince coupante est requise pour détacher chaque élément de sa grappe. Nous vous recommandons l'utilisation d'un grattoir pour ébarber les éléments. Pour l'assemblage, vous aurez également besoin de colle plastique. Games Workshop commercialise les Pinces de Précision Citadel, l'Ébarboir Citadel et la Colle Plastique Citadel, mais n'en recommande pas l'utilisation pour des enfants de moins de 16 ans sans la supervision d'un adulte.

**ESP** POR FAVOR, LEE CUIDADOSAMENTE ESTE LIBRETO DE INSTRUCCIONES ANTES DE EMPEZAR A MONTAR LAS MINIATURAS. Te harán falta unas tenazas para plástico a fin de separar las piezas de la matriz. También aconsejamos una herramienta para rebabas a fin de limpiar cada pieza. Para montar la miniatura necesitarás pegamento para plástico. Games Workshop vende Tenazas Citadel, Herramientas para rebabas Citadel y Pegamento para plástico Citadel, pero no recomienda estos productos a menores de 16 años sin la supervisión de un adulto.

**GER** VOR DEM ZUSAMMENBAU DER MINIATUREN BITTE DIE ANWEISUNGEN IN DIESER ANLEITUNG AUFMERKSAM DURCHLESEN. Du benötigst einen

Kunststoffseitenschneider, um die Kunststoffbauteile aus dem Gussrahmen herauszutrennen, und Kunststoffkleber, um die Miniatur zusammenzubauen. Außerdem empfehlen wir, die Bauteile vorher mit einem Gussgratentferner zu säubern. Games Workshop bietet Präzisions-Kunststoffseitenschneider von Citadel sowie Citadel-Kunststoffkleber an, empfiehlt aber, dass unter 16 Jahren diese nur unter Aufsicht eines Erwachsenen benutzen.

**ITA** PRIMA DI ASSEMBLARE LE TUE MINIATURE LEGGI ATTENTAMENTE TUTTE LE ISTRUZIONI DI QUESTO LIBRETTO. Sono necessarie un paio di tronchesine per plastici per staccare i componenti dai loro sprue. Consigliamo di usare un attrezzo apposito per pulire i componenti. Per assemblare il modello avrai bisogno di colla per plastica. Games Workshop vi consiglia questi prodotti ad un pubblico minore di 16 anni senza la supervisione di un adulto.

**日語** 本キット内のフレームからプラスチックパーツを切り離すためには、ニッパーが必要。ツールのモールドを平らにするには、専用ツールの使用をお勧めいたします。本キットの組み立ては、プラ用接着剤が必要です。ゲームズワークショップはシタデル・ニッパー、プラ用接着剤、モールドラインリムーバーを販売しておりますが、16歳以下の子供が大人の監督ならぬ道具を使用されることをお勧めしません。

**中文** 你需要一把模型剪将塑料部件从板件上剪下来。我们建议使用分模线刮刀来处理零件。你还需用到模型胶水。你可以从 Games Workshop 处购买到 Citadel Fine Detail Cutter 分模线刮刀和 Citadel Plastic Glue 模型胶。但 16 岁以下儿童没有成年人监护的情况下使用这些产品。

**1** LIEUTENANT HALDOR ICEPELT

**1 a**

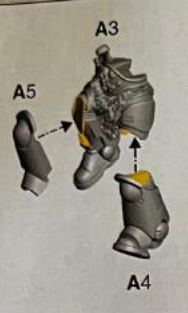
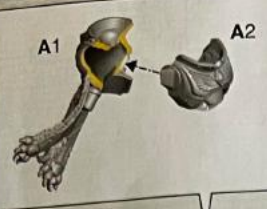

**1 b**

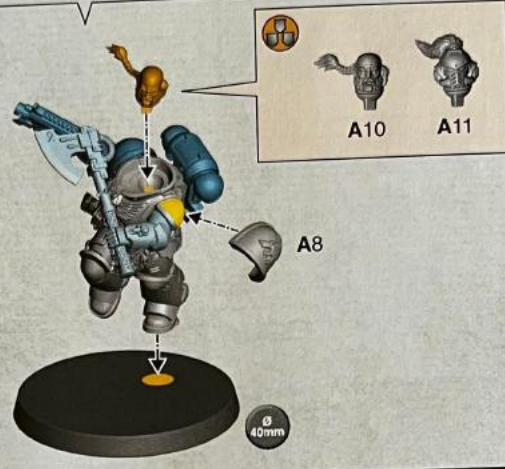

**2 - 7** PRIMARIS INTERCESSORS

**2 a x2**

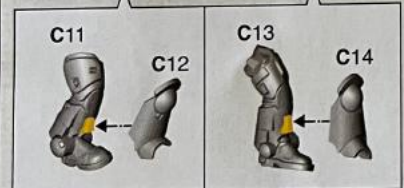
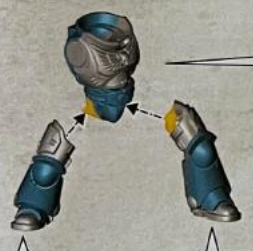

**2 b x2**

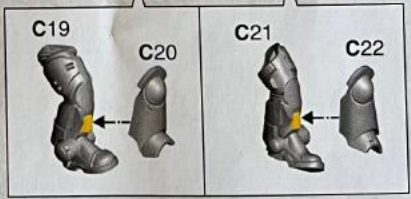
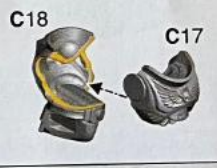

**2 c x2**

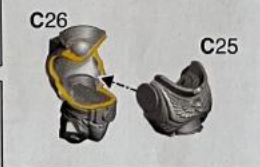

**2 d x2**

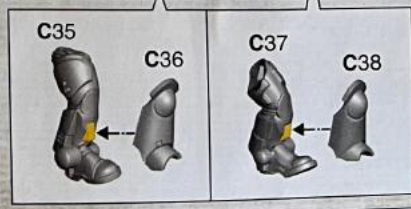

2 e x2



2 f 10



C43

C44

C45

C46



3 SERGEANT | SERGENT | SARGENTO | SERGEANT | SERGENTE | サージェント | 軍士

3 a

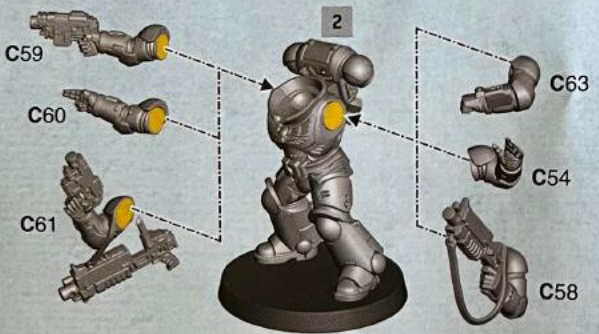

3 b



3 a

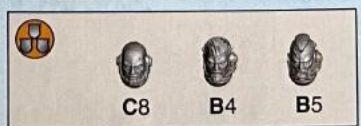
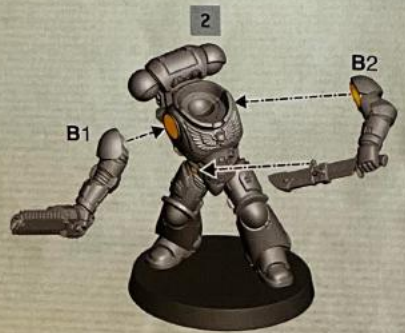

3 a

3 a

3 c



3 b

3 d

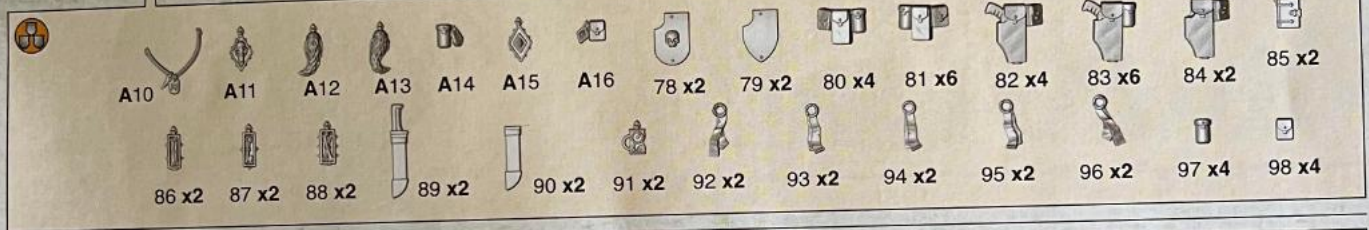

4 PRIMARIS INTERCESSORS | INTERCESSORS PRIMARIS | INTERCESORES PRIMARIS | INTERCESSOREN | INTERCESSORS PRIMARIS | プライマリス・インターセッサ | 原铸仲裁者

4 a x9

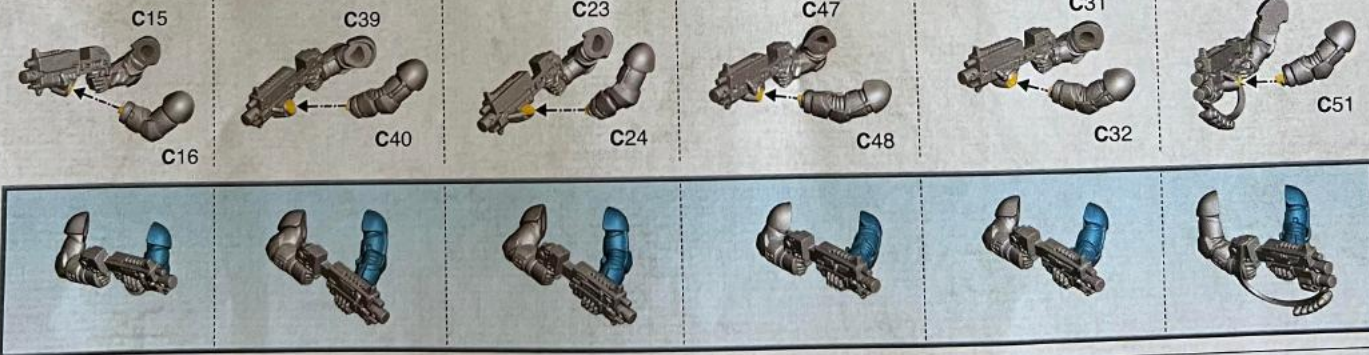

4 b x9



4 c x9

- C1 x10
- C3 x2
- C4 x2
- C5 x2
- C6 x2
- C7 x2
- C8 x2
- C4 x2
- B5 x2



4 d x9

- C69 x2
- C70 x2
- C71 x2
- C72 x2
- C73 x2
- C74 x2
- C77 x2



- B10
- B11
- B12
- B13
- B14
- B15
- B16
- C78
- C79
- C80
- C81
- C82
- C83
- C84
- C85
- C86
- C87
- C88
- C89
- C90
- C91
- C92
- C93
- C94
- C95
- C96
- C97
- C98



5 a



5 b



5 b

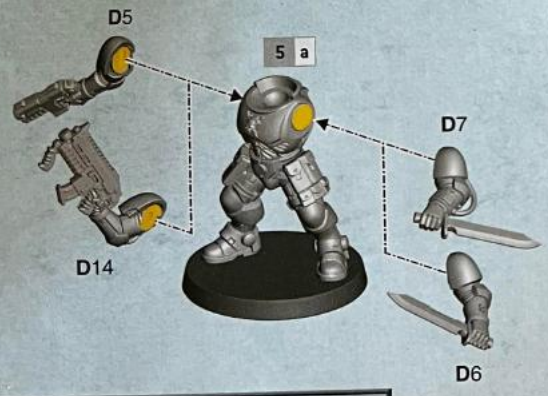

5 b

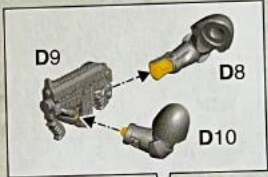

5 b

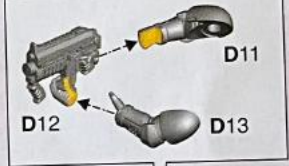

5 c

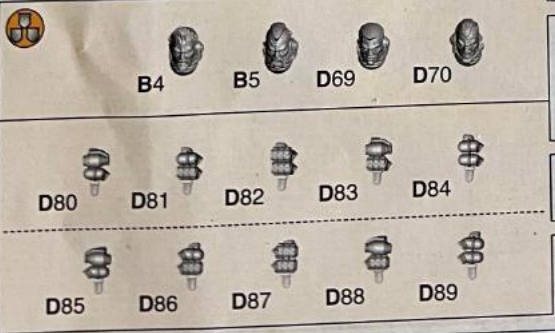

5 d



5 c

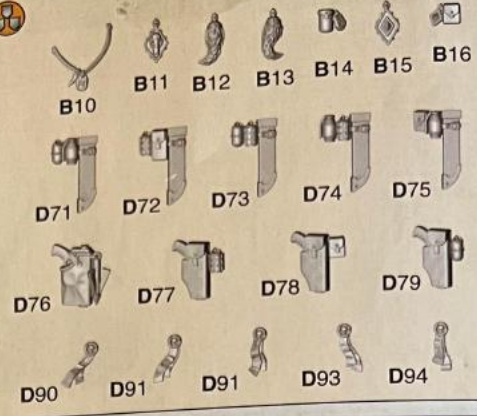

6-10

PRIMARIS REVERS | REIVERS PRIMARIS | SAQUEADORES PRIMARIS | EXTERNATOREN | OPPRESSORI PRIMARIS | プライマリス・レイヴナー | 原铸掠夺者

6 a

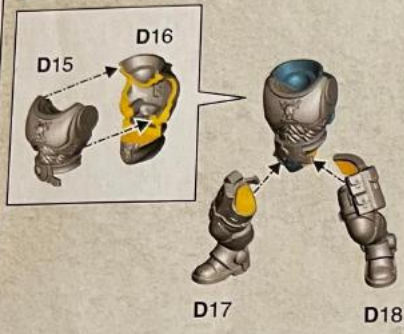

32mm

! 6 b



6 b

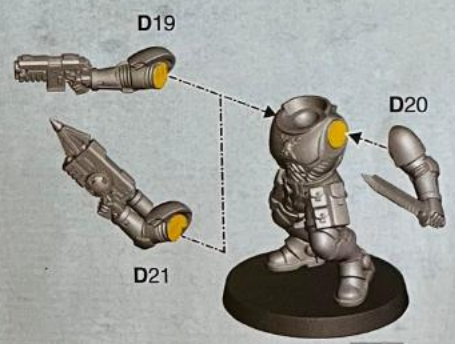

6 a



6 b

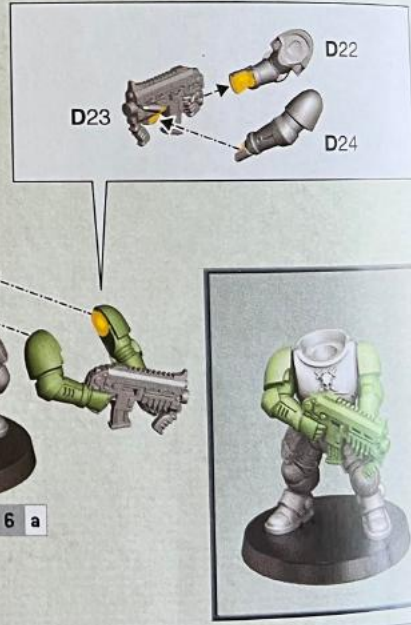

6 a

7 a

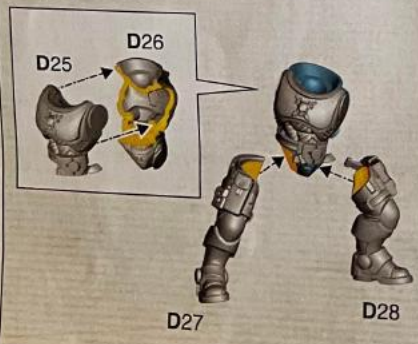

32mm

! 7 b





7 b



7 b

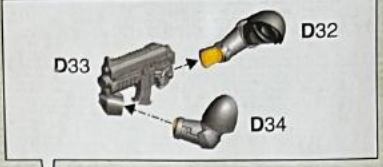

8 a

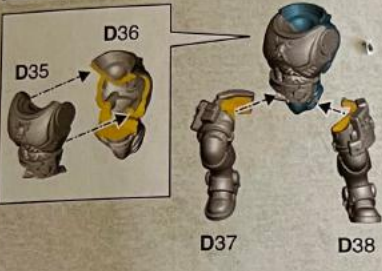

8 b



8 b



8 b

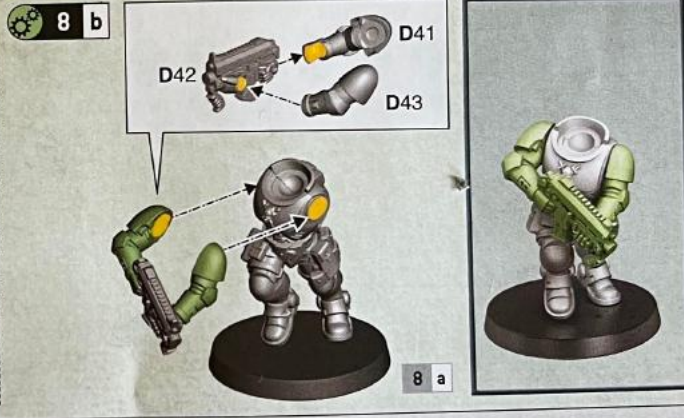

9 a



9 b



9 b



9 b



9 b

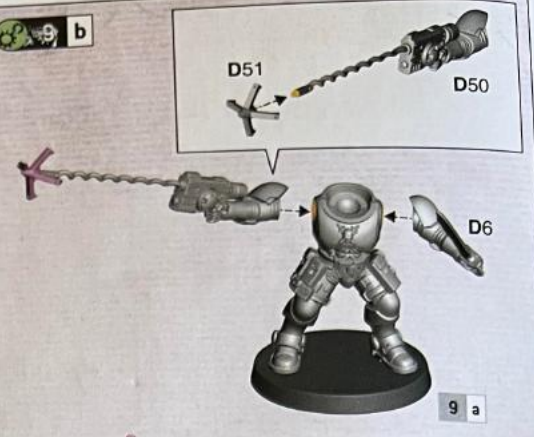

10 a x4



10 b x4

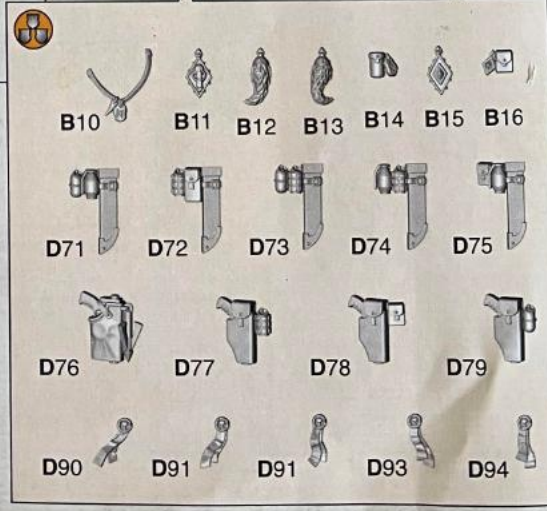
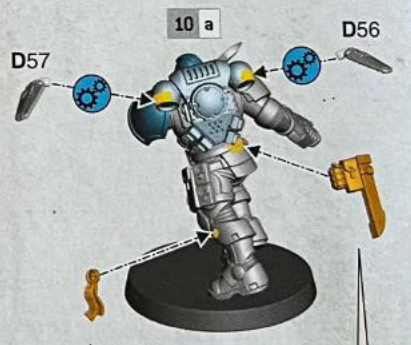

11 a

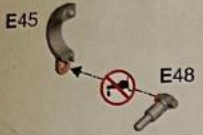

11 b

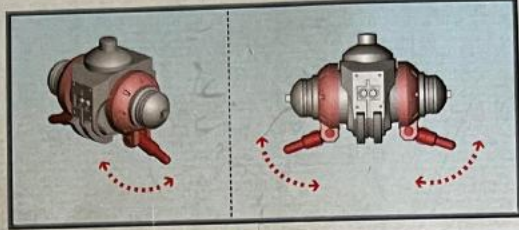

11 c



11 d

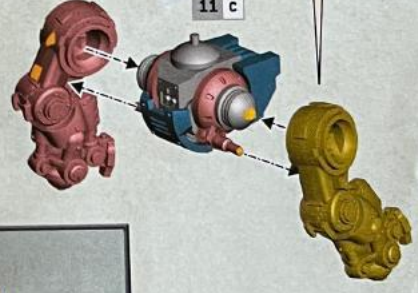
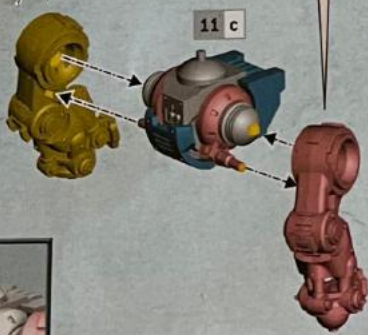
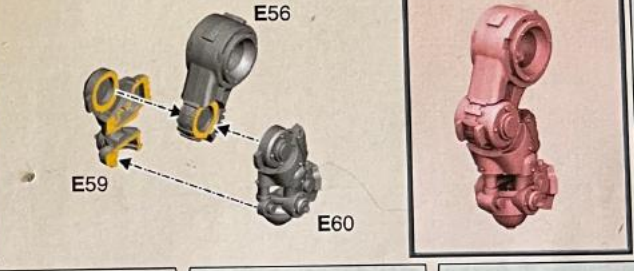

90mm



90mm

11 e

11 f

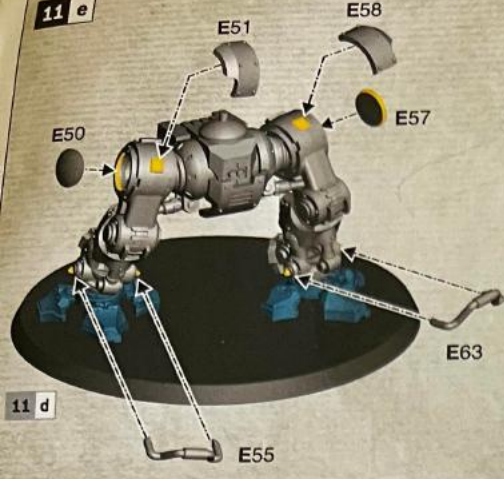

12 a

12 b

12 a

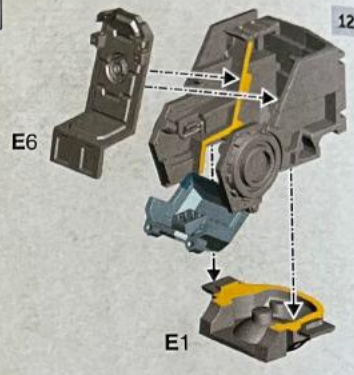
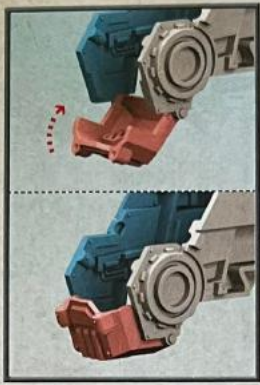
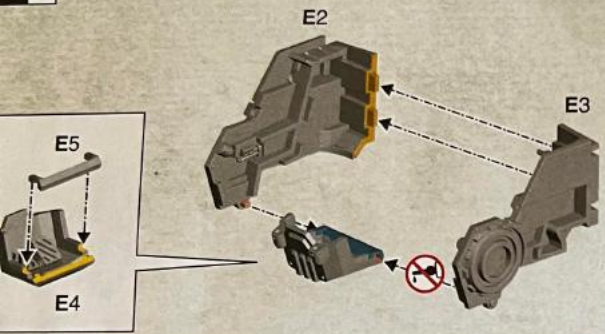

c

12 b

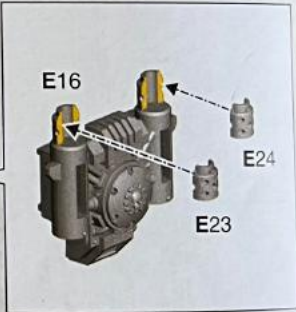
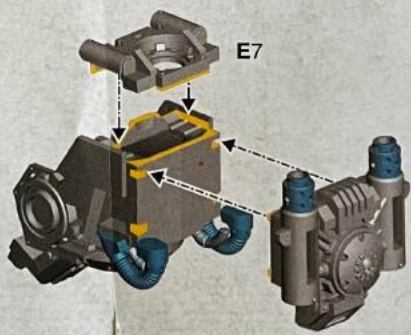
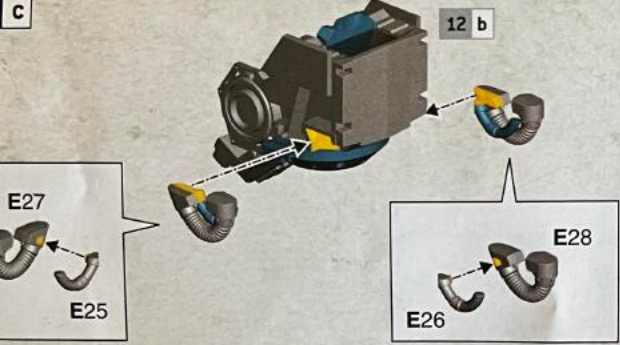

d

12 e

12 d

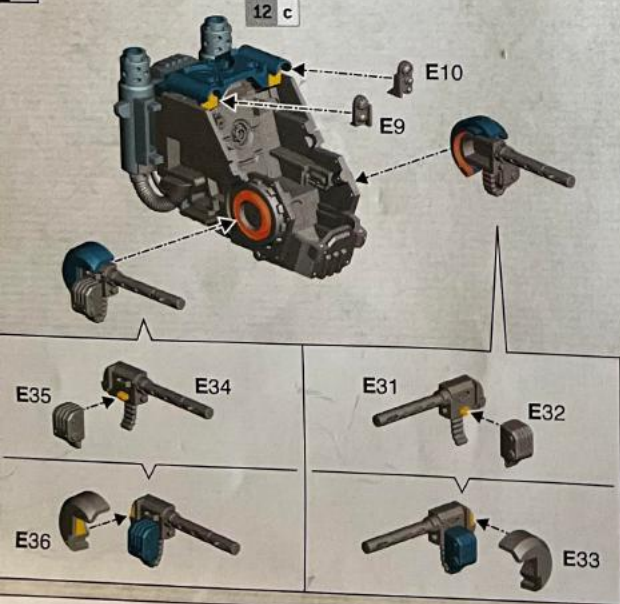

12 f

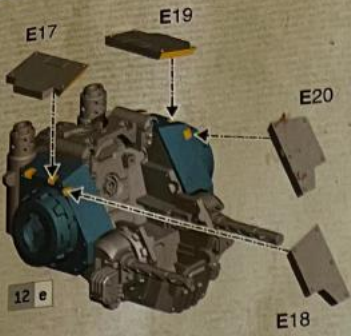

E111 E112 E113



12 g

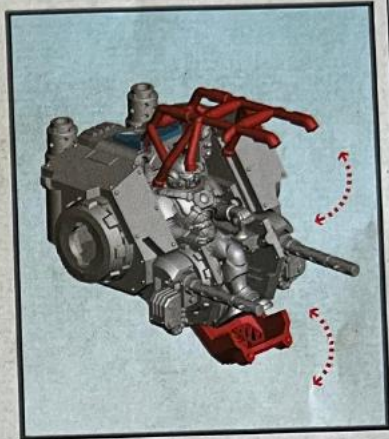
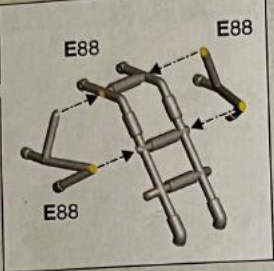

12 h

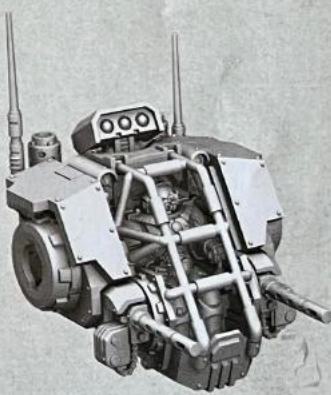
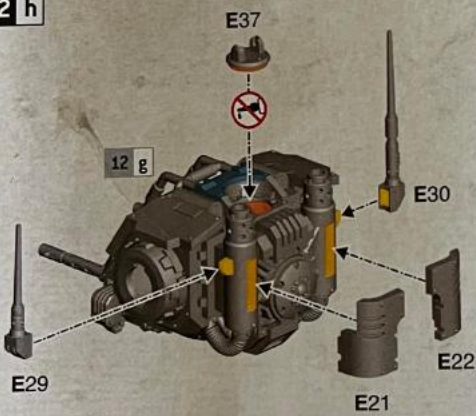

13 a

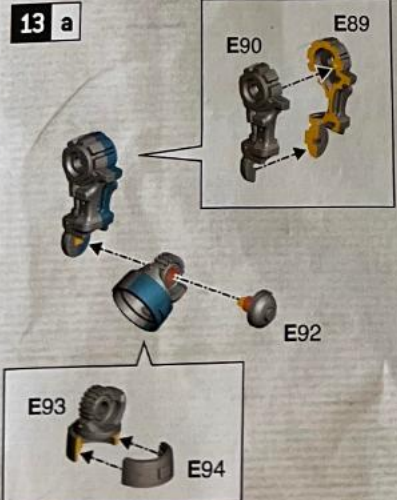

13 b

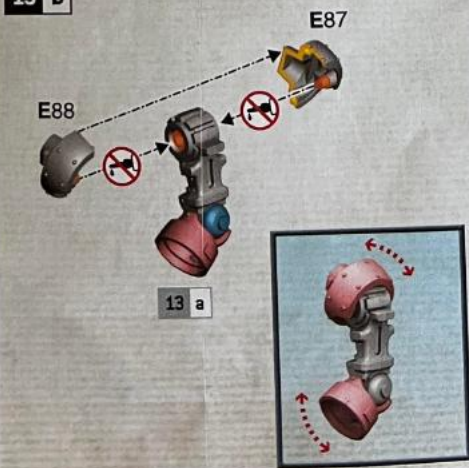

13 c

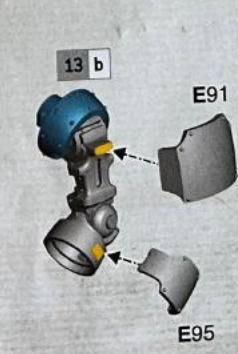

14 d

14 c

14 c

14 b

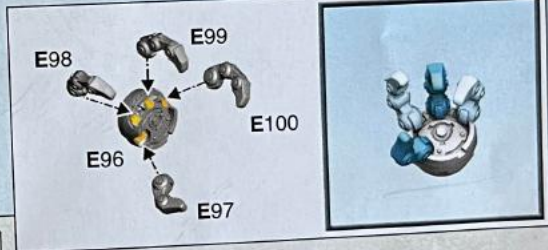
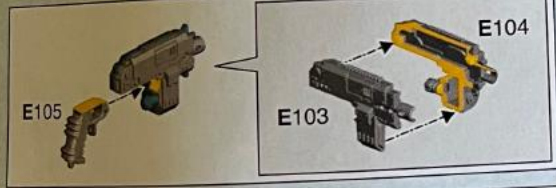
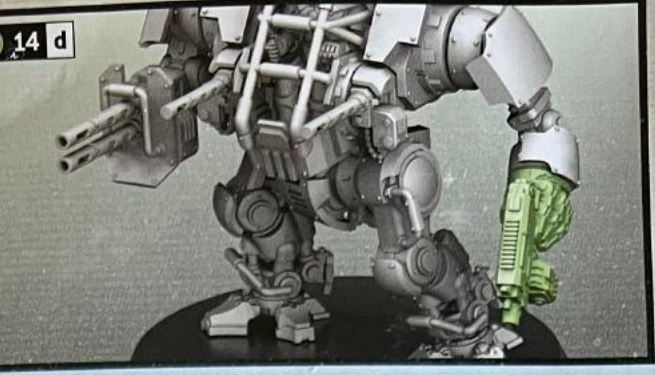

14 d

14 b

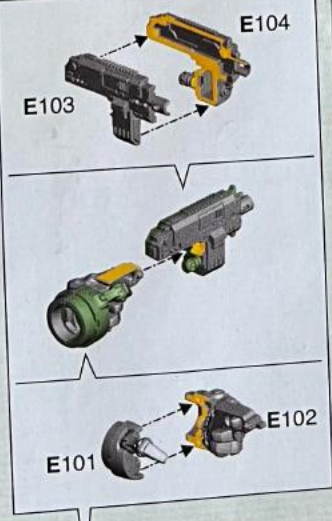

**ENG** Used along with the rules for your new unit on the battlefield. For the full rules for Warhammer 40,000, see the rulebook. **FR** Utilisez avec les règles de base de Warhammer 40,000. Pour les règles complètes de cette unité, référez-vous au Codex correspondant à votre armée. **ESP** Usadas junto a las reglas básicas que encontrarás en Warhammer 40,000. Para ver las reglas completas de esta unidad, consulta el Codex de tu ejército. **GER** Wenn du die Regeln unten zusammen mit den Grundregeln auf Warhammer 40,000 verwendest, kannst du deine Einheit direkt auf das Schlachtfeld führen. Die vollständigen Regeln für diese Einheit findest du im entsprechenden Codex für deine Armee.

**ENG** Used along with the rules for your new unit on the battlefield. For the full rules for Warhammer 40,000, see the rulebook. **FR** Utilisez avec les règles de base de Warhammer 40,000. Pour les règles complètes de cette unité, référez-vous au Codex correspondant à votre armée. **ESP** Usadas junto a las reglas básicas que encontrarás en Warhammer 40,000. Para ver las reglas completas de esta unidad, consulta el Codex de tu ejército. **GER** Wenn du die Regeln unten zusammen mit den Grundregeln auf Warhammer 40,000 verwendest, kannst du deine Einheit direkt auf das Schlachtfeld führen. Die vollständigen Regeln für diese Einheit findest du im entsprechenden Codex für deine Armee.

### LIEUTENANT HALDOR ICEPELT

LIEUTENANT HALDOR ICEPELT | TENIENTE HALDOR ICEPELT DE LOS ESPACIOWOLVES-LIEUTENANT HALDOR ICEPELT | スペースウルフ・レフテナント・ハルダール・アイスベルト | 太空野狼副官哈尔多·冰皮

6"	2+	2+	4	4	4	3	8	3+
----	----	----	---	---	---	---	---	----

1	24"	☞
2	☞	☞



### PRIMARIS INTERCESSORS

INTERCESSORS PRIMARIS | INTERCESORES PRIMARIS | INTERCESSOREN | INTERCESSORS PRIMARIS | プライマリクス・インターセプサー | 原铸仲裁者

6"	3+	3+	4	4	2	2	7	3+
6"	3+	3+	4	4	2	3	8	3+

1	24"	☞	3	4	0	1
2	30"	☞	D6	3	0	1
3	30"	☞	1	6	-1	D3
4	12"	☞	1	4	0	1
5	30"	☞	1	4	-1	1
6	36"	☞	1	4	-2	2



### PRIMARIS REIVERS

REIVERS PRIMARIS | SAQUEADORES PRIMARIS | EXTERNATOREN | OPPRESSORI PRIMARIS | プライマリクス・レイヴナー | 原铸掠夺者

6"	3+	3+	4	4	2	2	7	3+
6"	3+	3+	4	4	2	3	8	3+

1	12"	☞	1	4	-2	1
2	24"	☞	2	4	0	1
3	☞	☞	☞	0	1	
4	6"	☞	D6	3	0	1
5	6"	☞	1	6	-1	D3



### INVICTOR TACTICAL WARSUIT

EXO-HARNAIS TACTIQUE INVICTOR PRIMARIS | EXDESQUELETO TÁCTICO INVICTOR PRIMARIS DE LOS MARINES ESPACIALES | TAKTISCHER KRIEGSANZUG INVICTOR | ARMATURA TATTICA INVICTOR PRIMARIS | スペースマリーン・プライマリクス・インヴィクター・タクティカル・ウォースーツ | 基因原体战术铠甲

10"	3+	3+	7	6	13	4	8	3+
8"	4+	4+	7	6	N/A	4	8	3+
6"	5+	5+	7	6	N/A	4	8	3+

1	18"	☞	D6	4	0	1
2	36"	☞	3	5	-1	2
3	12"	☞	2D6	5	-1	1
4	36"	☞	8	4	-1	1
5	48"	☞	6	7	-1	2
6	☞	☞	x2	-3	3	

