



Free Downloads of Build Instructions,
Assembly Booklets & How To Guides

BuildInstructions.com

WARHAMMER® THE HORUS HERESY™

SOLAR AUXILIA LEMAN RUSS ASSAULT TANK



READ THIS FIRST | À LIRE EN PRIORITÉ | BITTE BEACHTE | LEE ESTO PRIMERO | LEGGI PRIMA QUESTO | 最初に読んでください | 讀む先阅读

EN BEFORE ASSEMBLING YOUR MINIATURES, PLEASE READ THROUGH THE INSTRUCTIONS IN THIS BOOKLET CAREFULLY.
A pair of plastic cutters is required to remove the plastic components in this kit from their frame. We advise using a mouldline scraping tool to clean up the parts. To assemble your model you will need plastic glue. Games Workshop will sell Citadel Fine Detail Cutters, Citadel Mouldline Removers and Citadel Plastic Glue, but does not recommend these products for use by children under the age of 16 without adult supervision.

FR AVANT D'ASSEMBLER VOS FIGURINES, VEUILLEZ LIRE ATTENTIVEMENT LES INSTRUCTIONS DE CE LIVRET.
Une pince coupante est requise pour détacher chaque élément de sa grappe plastique. Nous vous recommandons l'utilisation d'un ébarbot pour gratter chaque élément. Pour l'assemblage, vous aurez besoin de colle plastique. Games Workshop commercialise les Pinces de Précision Citadel, l'Ébarbot Citadel et la Colle Plastique Citadel, mais n'en recommande pas l'utilisation aux enfants de moins de 16 ans sans la supervision d'un adulte.

ES POR FAVOR, LEE CUIDADOSAMENTE ESTE LIBRETO DE INSTRUCCIONES ANTES DE EMPEZAR A MONTAR LAS MINIATURAS.
Te harán falta unas tenazas para plástico a fin de separar las piezas de la masa. También aconsejamos una herramienta para quitar rebabas a fin de limpiar cada pieza. Para montar la miniatura necesitarás pegamento para plástico. Games Workshop vende tenazas de detalle superfinas, Quitarrabajas Citadel y Pegamento para plástico Citadel, pero no recomienda estos productos a menores de 16 años sin supervisión de un adulto.

DE VOR DEM ZUSAMMENBAU DER MINIATUREN BITTE DIE ANWEISUNGEN IN DIESER ANLEITUNG AUFMERKSAM DURCHLESEN.
Du benötigst einen Kunststoffschneidewerkzeug, um die Kunststoffbauteile aus dem Gussrahmen herauszubringen. Außerdem empfehlen wir, die Bauteile mit einem Gussgratentferner zu säubern. Um dein Modell zusammenzubauen, benötigst du Kunststoffkleber. Games Workshop bietet Präzisions-Feinwerkzeuge und Gussgratentferner von Citadel sowie Citadel-Kunststoffkleber an, empfiehlt aber, dass Kinder unter 16 Jahren diese nur unter Aufsicht eines Erwachsenen benutzen.

IT PRIMA DI ASSEMBLARE LE TUE MINIATURE LEGGI ATTENTAMENTE TUTTE LE ISTRUZIONI DI QUESTO LIBRETTO.
Sono necessarie un paio di tronchese per plastica per staccare i componenti dal loro sprato. Consigliamo di usare un attrezzo apposito per pulire i componenti. Per assemblare il modello avrai bisogno di colla per plastica. Games Workshop vende Tronchese di ultraprecisione Citadel. Attrezzo per rigolare Citadel e Colla per plastica Citadel, ma non consiglia questi prodotti ad un pubblico minore di 16 anni senza la supervisione di un adulto.

CH 組立前に必ず説明書をお読みください。
キットのプラステックパーツをフレームから取り出すには、キッターが必要で、パーツのキレを平らにするには、専用ツールを使用する必要があります。キットを組み立てるには、プラステック接着剤が必要です。ゲームワークショップは、シタデル・ファインディテール・キッター、シタデル・プラステックグレイプ、シタデル・グリス・トリム・ツールを販売していますが、16歳未満の子供が、人の監督なしでこれらの道具を使用することを勧めていません。

CA 在裝裝您的模型前，請仔細閱讀本手冊中的說明。
您將需要一把塑料剪來將零件從其框架上取下。我們建議您使用專用的修邊器來清理零件。組裝模型時，您將需要塑料膠水。我們提供 Citadel 精細剪、Citadel 修邊器、Citadel 精細修邊器、Citadel 精細修邊器、Citadel 精細修邊器，但不建議 16 歲以下兒童在沒有成人監督的情況下使用這些產品。



Citelad Plastic Glue
Colle plastique Citelad
Pegamento para plástico Citelad
Citelad-Kunststoffkleber
Colla per plastica Citelad
シタデルプラスチック接着剤
Citelad 塑料专用粘胶



Super Fine Detail Cutters
Pinces Coupante de Précision
Tenazas de detalle superfino
Präzisions-Seitenschneider
Tronchesine di ultraprecisione
スーパー・ファインディテール・カッター
精密剪鉋



Mouldline Remover
Ebarbois
Quitarrababas
Gussgratentferner
Atrezzo per ripulire
モールドライン・リムーバー
合模线刮刀

EXPLANATION OF SYMBOLS | EXPLICATION DES SYMBOLES | EXPLICACIÓN DE SÍMBOLOS
ERLÄUTERUNG DER SYMBOLE | LEGENDA DEI SIMBOLI
アイコン解説 | 符号説明



• Choice of parts
• Choix d'éléments
• Piezas opcionales
• Auswahl an Teilen
• Scelta di componenti
• パーツの選択
• 选择部件



• Variant assembly
• Variante d'assemblage
• Variante de montaje
• Bauvariante
• Assemblaggio alternativo
• 組み立てバリエーション
• 多种组装方式



• Repeat process
• Répéter l'étape
• Repetir pasos
• Vorgang wiederholen
• Ripetiti il processo
• 同じ作業を繰り返すこと
• 重复步骤



• Detail view
• Vue détaillée
• Vista detallada
• Alternative Ansicht
• Visuale del dettaglio
• 拡大
• 局部放大视图



• Do not glue the components
• Ne pas coller les éléments
• No pegar los componentes
• Bitte die Teile nicht kleben
• Non incollare i componenti
• このパーツは接着不可
• 请勿粘胶



• Stage complete
• Étape terminée
• Paso completado
• Schritt abgeschlossen
• Fase completa
• このステップの完成
• 完成

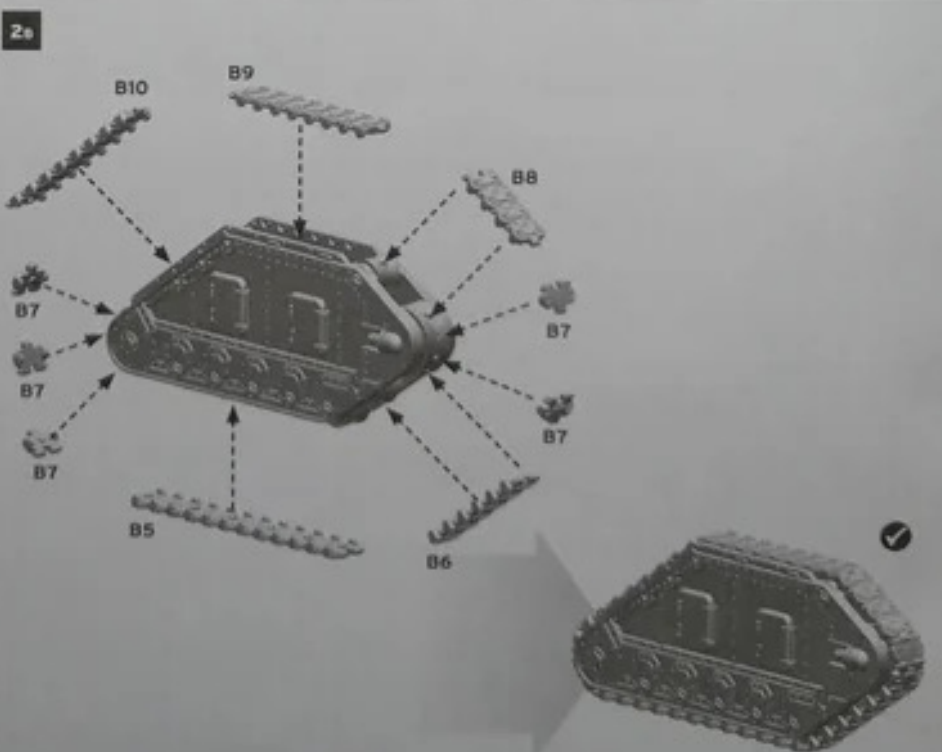
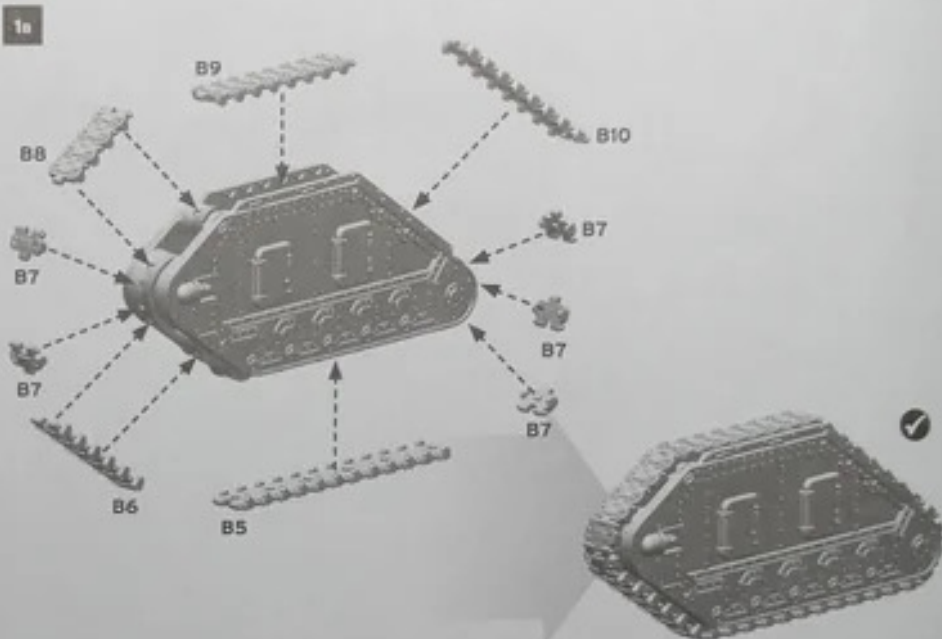

3a

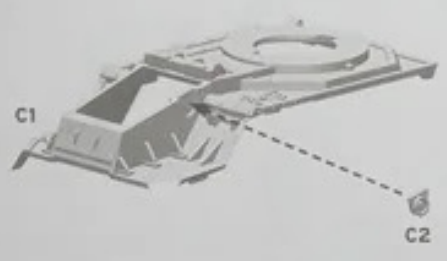

3b

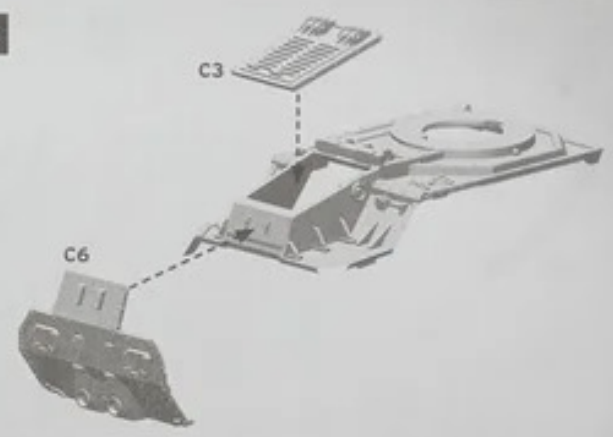

3c

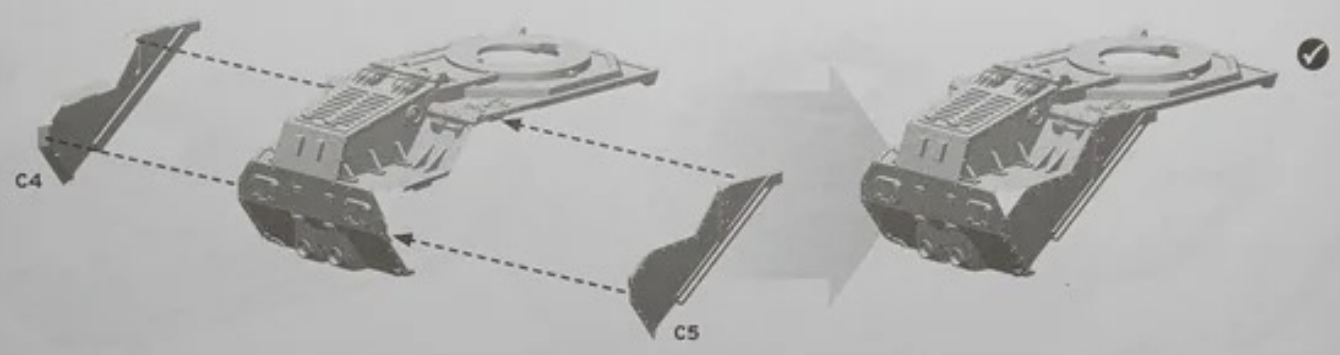

4a

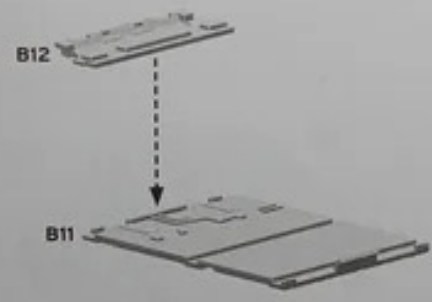

4a

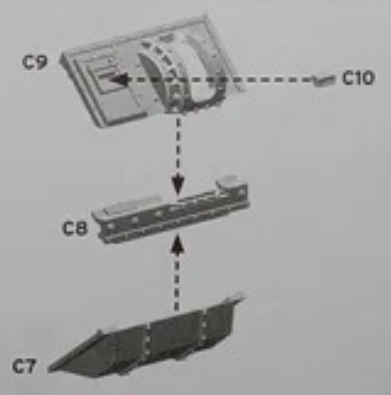

4c

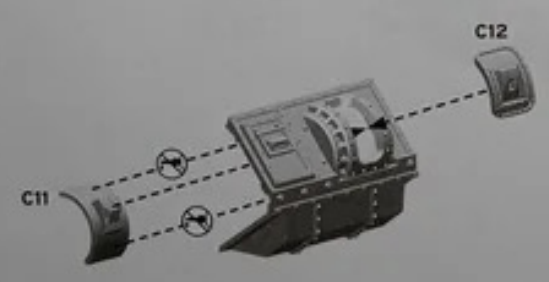

4e

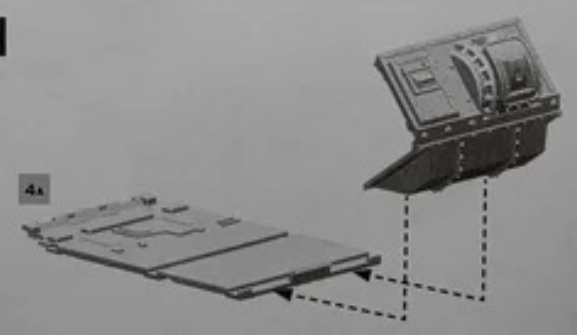

4c

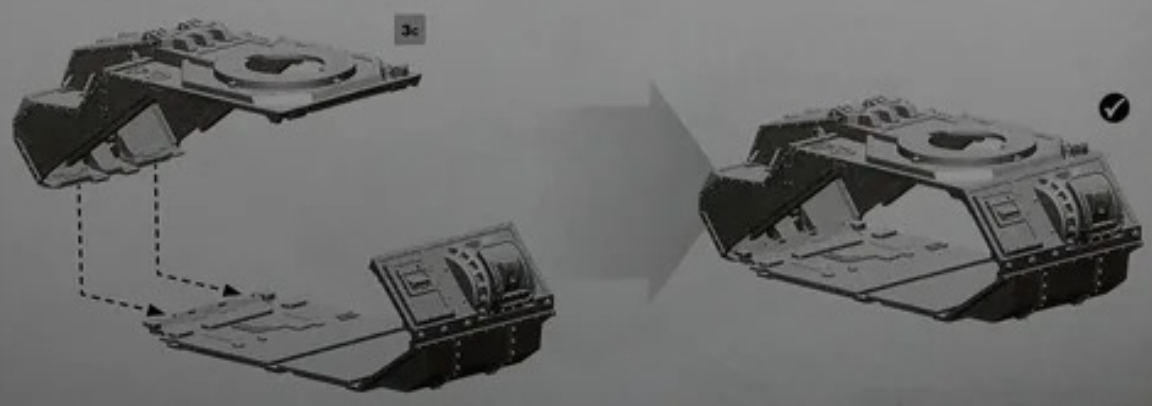

5a 12

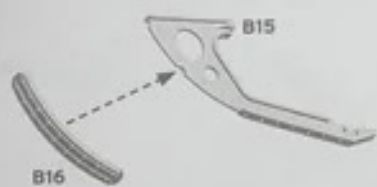

5a

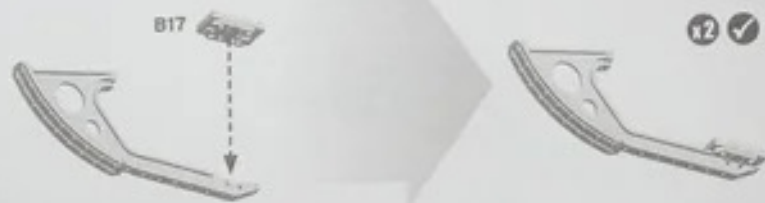

6



7

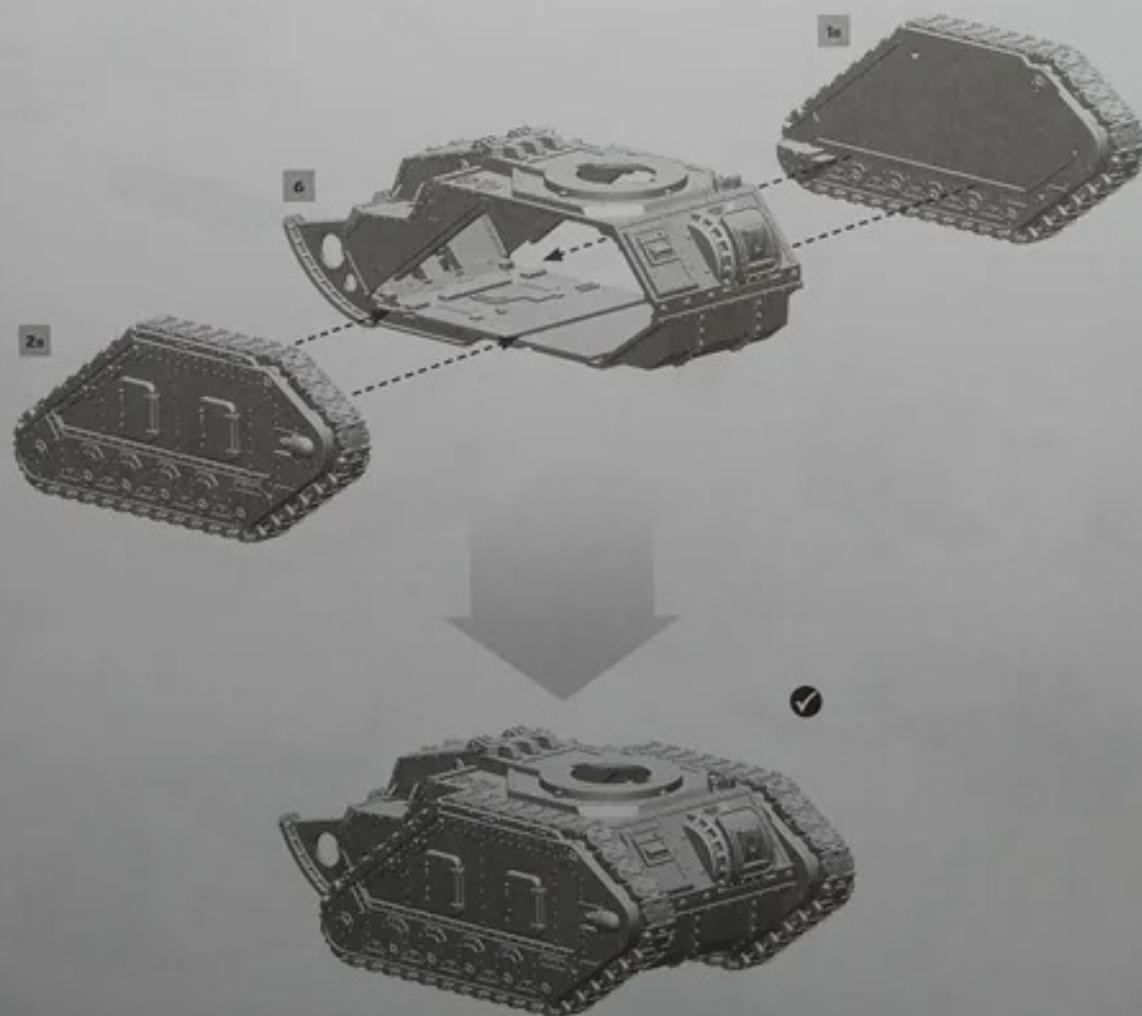

8

12

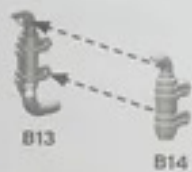

9a

9

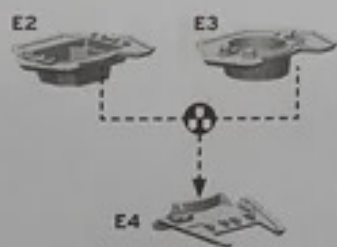

9a



10



11





DEMOLISHER CANNON

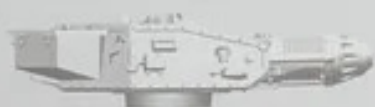

EXECUTIONER PLASMA CANNON



VOLKITE MACRO-SAKER

DEMOLISHER CANNON

12



13



14A

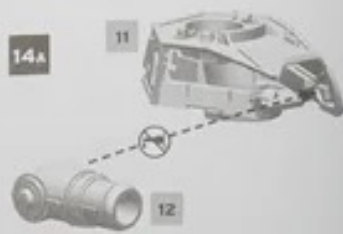

14B

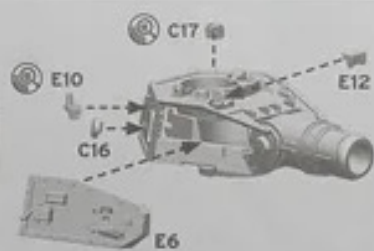

14C



EXECUTIONER PLASMA CANNON

15A



15B



15C

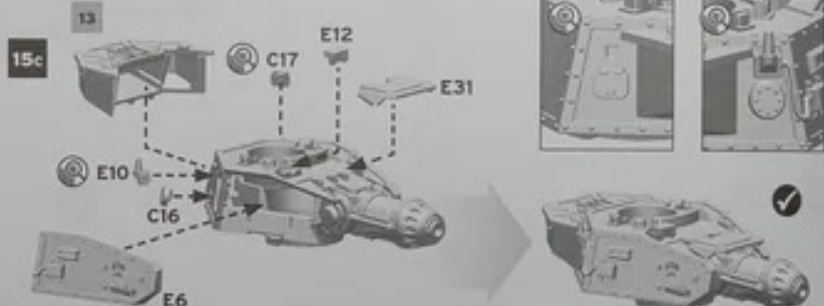

VOLKITE MACRO-SAKER

16A

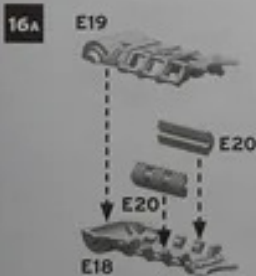

16B



16C



16D



16E



16F



16G



17A



17B



18a



18b



18c

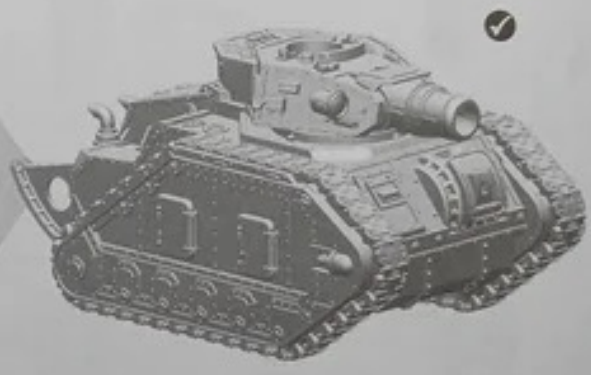
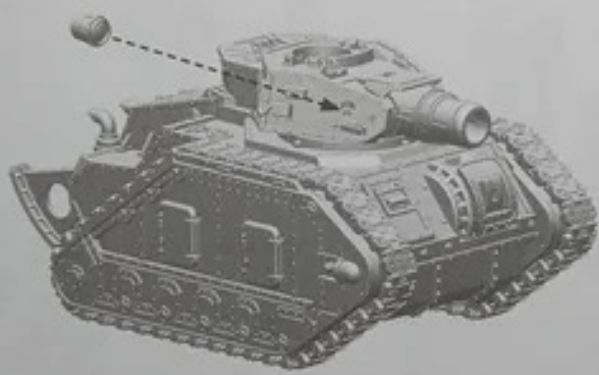

19a



19a



W2



W5



20

- Heavy Bolter
- Lascannon
- W1. Autocannon
- W4. Multi-laser
- W7. Heavy Flamer

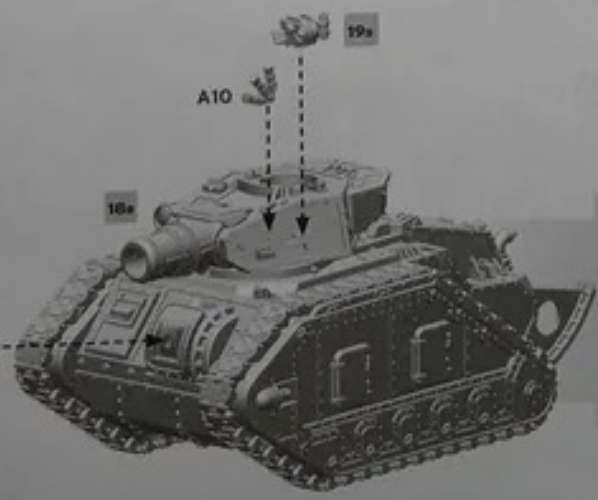

21

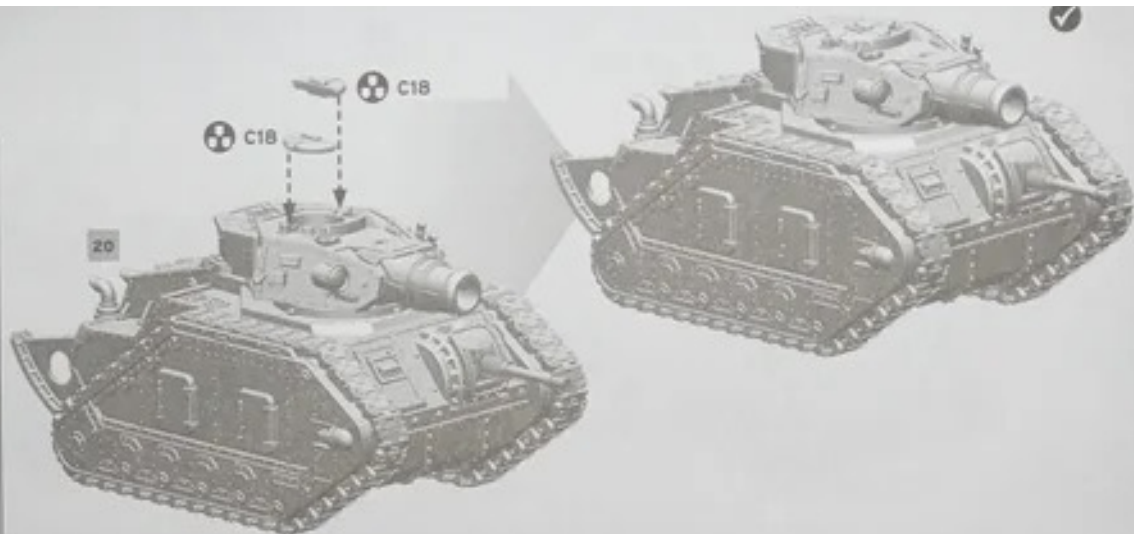

☉ TANK COMMANDER

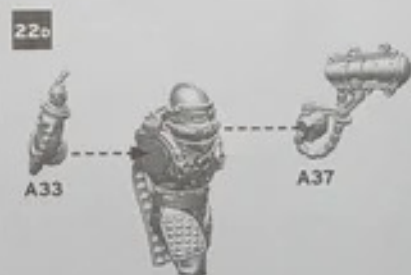

24

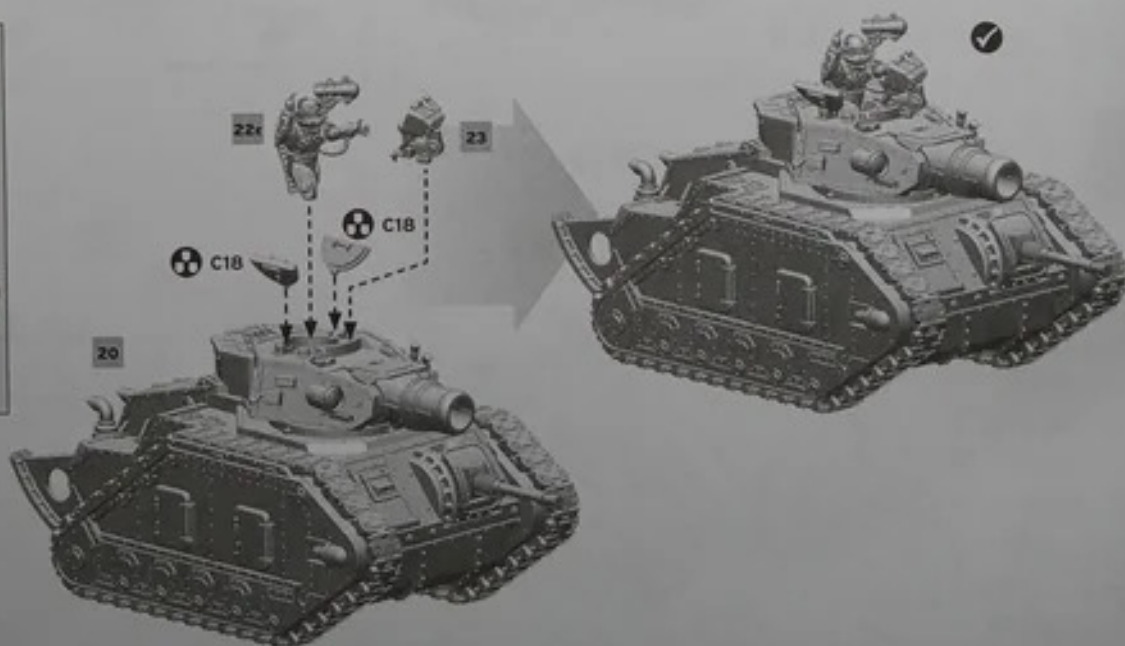

TANK COMMANDER WITH PINTLE WEAPON

25

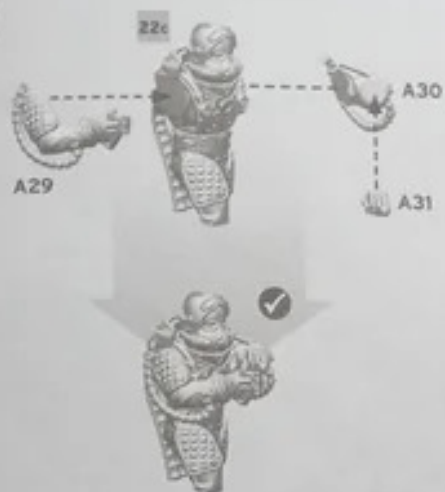

26



