



Free Downloads of Build Instructions,
Assembly Booklets & How To Guides

BuildInstructions.com

WARHAMMER® THE HORUS HERESY™

SOLAR AUXILIA BATTLE GROUP



READ THIS FIRST | À LIRE EN PRIORITÉ | BITTE BEACHT E | LEE ESTO PRIMERO | LEGGI PRIMA QUESTO | 最初にお読みください。| 請優先閱讀

EN BEFORE ASSEMBLING YOUR MINIATURES, PLEASE READ THROUGH THE INSTRUCTIONS IN THIS BOOKLET CAREFULLY.

A pair of plastic cutters is required to remove the plastic components in this kit from their frame. We advise using a mouldline scraping tool to clean up the parts. To assemble your model you will need plastic glue. Games Workshop sells Citadel Fine Detail Cutters, Citadel Mouldline Removers and Citadel Plastic Glue, but does not recommend these products for use by children under the age of 16 without adult supervision.

FR AVANT D'ASSEMBLER VOS FIGURINES, VEUILLEZ LIRE ATTENTIVEMENT LES INSTRUCTIONS DE CE LIVRET.

Une pince coupante est requise pour détacher chaque élément de sa grappe plastique. Nous vous recommandons l'utilisation d'un ébarboir pour gratter chaque élément. Pour l'assemblage, vous aurez besoin de colle plastique. Games Workshop commercialise les Pinces de Précision Citadel, l'Ébarboir Citadel et la Colle Plastique Citadel, mais n'en recommande pas l'utilisation aux enfants de moins de 16 ans sans la supervision d'un adulte.

ES POR FAVOR, LEE CUIDADOSAMENTE ESTE LIBRETO DE INSTRUCCIONES ANTES DE EMPEZAR A MONTAR LAS MINIATURAS.

Te harán falta unas tenazas para plástico a fin de separar las piezas de la matriz. También aconsejamos una herramienta para quitar rebabas a fin de limpiar cada pieza. Para montar la miniatura necesitarás pegamento para plástico. Games Workshop vende Tenazas de detalle superfino, Quitarebabas Citadel y Pegamento para plástico Citadel, pero no recomienda estos productos a menores de 16 años sin supervisión de un adulto.

DE VOR DEM ZUSAMMENBAU DER MINIATUREN BITTE DIE ANWEISUNGEN IN DIESER ANLEITUNG AUFMERKSAM DURCHLESEN.

Du benötigst einen Kunststoffseitschneider, um die Kunststoffbauteile aus dem Gussrahmen herauszutrennen. Außerdem empfehlen wir, die Bauteile mit einem Gussgratentferner zu säubern. Um dein Modell zusammenzubauen, benötigst du Kunststoffkleber. Games Workshop bietet Präzisions-Seitschneider und Gussgratentferner von Citadel sowie Citadel-Kunststoffkleber an, empfiehlt aber, dass Kinder unter 16 Jahren diese nur unter Aufsicht eines Erwachsenen benutzen.

IT PRIMA DI ASSEMBLARE LE TUE MINIATURE LEGGI ATTENTAMENTE TUTTE LE ISTRUZIONI DI QUESTO LIBRETTO.

Sono necessarie un paio di tronchesine per plastica per staccare i componenti dal loro sprue. Consigliamo di usare un attrezzo apposito per pulire i componenti. Per assemblare il modello avrai bisogno di colla per plastica. Games Workshop vende Tronchesine di ultraprecisione Citadel, Attrezzo per ripulire Citadel e Colla per plastica Citadel, ma non consiglia questi prodotti ad un pubblico minore di 16 anni senza la supervisione di un adulto.

EN 始める前に必ず説明書をお読みください。

本キット内のフレームからプラスチックパーツを切り離すためには、ニッパーが必要です。パーツのモールドを平らにするには、磨削ツールの使用をお勧めいたします。本キットの組み立てには、プラ用接着剤が必要です。ゲームズワークショップはスーパー・ファインディテール・カッター、シタデル・プラスチックグラー、シタデル・モールドラインリムーバーを販売しておりますが、16歳以下の子供が大人の監督なしにこれらの道具を使用されることをお勧めしません。

FR 在組裝您的迷你模型之前，請仔細閱讀本手冊中的說明。

您需要一把模型剪將塑料零件從製作上拆下來。我們建议使用模型刮刀来处理零件。组装时您还需要用到塑料胶水。您可以从 Games Workshop 处购买到 Citadel 精密剪剪、Citadel 模线刮刀和 Citadel 塑料胶水。但 16 岁以下儿童不得在没有成年人监护的情况下使用这些产品。

16+



Citadel Plastic Glue
Colle plastique liquide Citadel
Pegamento para plástico fluido
Citadel-Kunststoffkleber
Cola per plastica Citadel
シタデルプラスチック接着剤
Citadel 用粘着剤



Mouldline Remover
Ebarboir
Quita-rebasas
Gussgratentferner
Atrezzo per ripulire
モールドライン・リムーバー
合模线刮刀



Super Fine Detail Cutters
Pince Coupante de Précision
Tenazas de detalle superfino
Präzisions-Seitenschneider
Tronchesine di ultraprecisione
スーパー・ファインディテール・カッター
精密剪鉋

EXPLANATION OF SYMBOLS | EXPLICATION DES SYMBOLES
EXPLICACIÓN DE SÍMBOLOS | ERLÄUTERUNG DER SYMBOLE
LEGENDA DEI SIMBOLI | アイコン解説 | 符号説明



• Choice of parts
• Pizzas opcionales
• Auswahl an Teilen
• Scelta di componenti
• パーツの選択
• 選擇部份



• Do not glue the components
• Ne pas coller les éléments
• No pegar los componentes
• Bitte die Teile nicht kleben
• Non incollare i componenti
• このパーツは接着不可
• 請勿黏接



• Stage complete
• Étape terminée
• Paso completado
• Schritt abgeschlossen
• Fase completa
• このステージの完成
• 完成



• Detail view
• Vue détaillée
• Vista detallada
• Alternative Ansicht
• Visual del dettaglio
• 拡大
• 局部拡大視図



• Repeat process
• Répéter l'étape
• Repetir pasos
• Vorgang wiederholen
• Ripeti il processo
• 同じ作業を繰り返すこと
• 重複作業



• Variant assembly
• Variante d'assemblage
• Variante de montaje
• Bauvariante
• Assemblaggio alternativo
• 組み立てバリエーション
• 多種組立方式



• Assembly sequence
• Séquence d'Assemblage
• Secuencia de montaje
• Baureihenfolge
• Sequenza di assemblaggio
• 組み立て手順
• 組立順序



• Build the number required, up to the limit shown
• Assembler le nombre requis, jusqu'à la limite indiquée
• Monta la cantidad requerida, hasta el límite mostrado
• Bau die benötigte Anzahl, bis zum angegebenen Limit
• Assembla il numero richiesto, fino al limite indicato
• 示されている上限を超えないように、必要数を組み立てること
• 指定された積立数以上は不可

SOLAR AUXILIA LASRFLE SECTION

99383005002

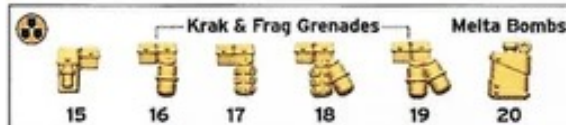

AUXILIA SERGEANT

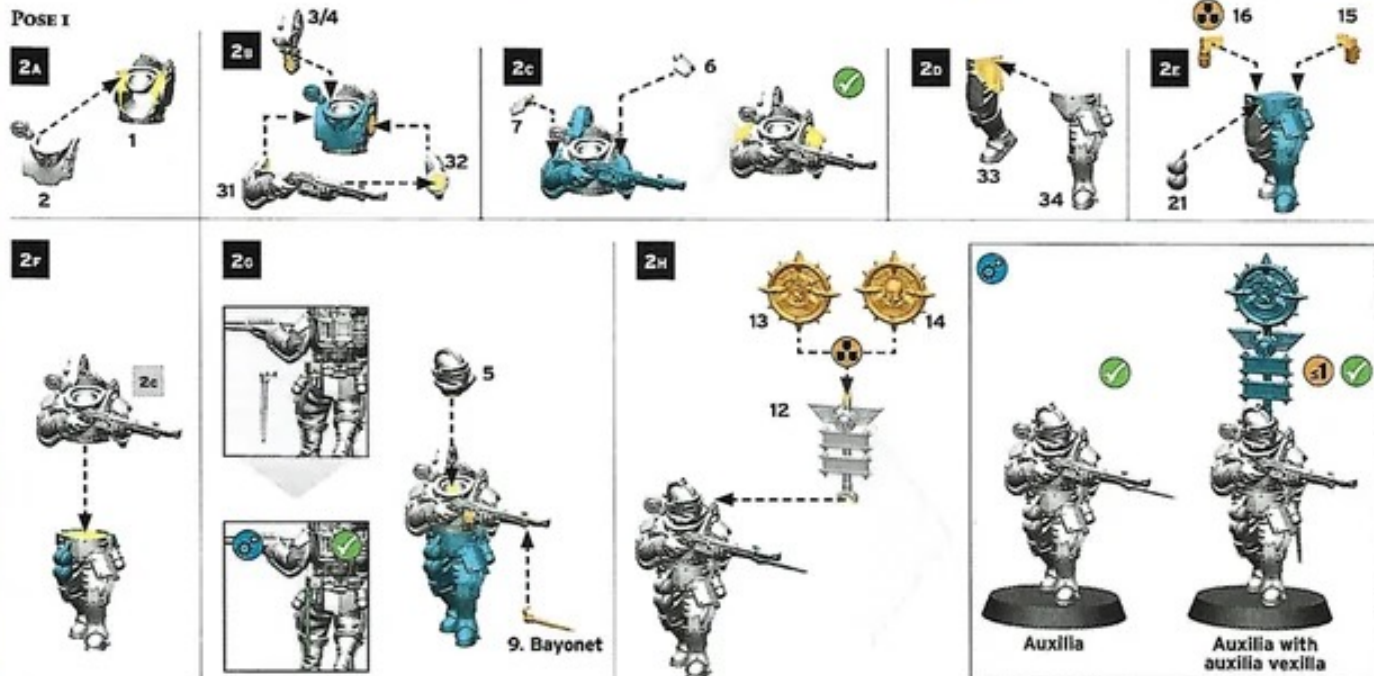
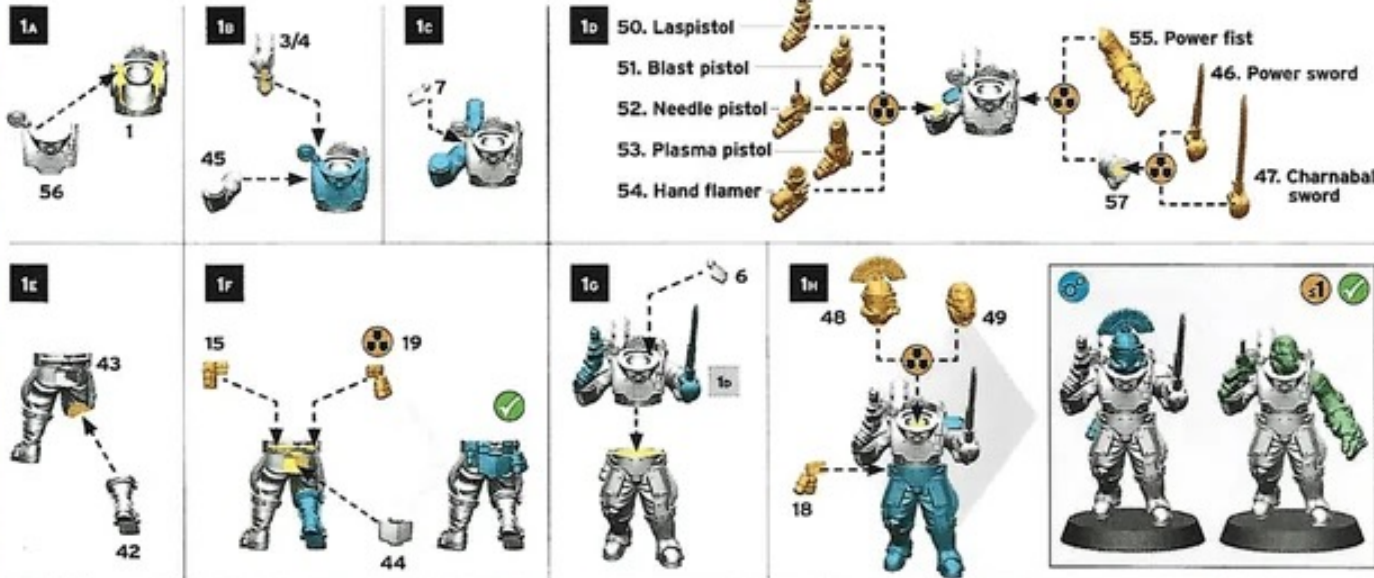

Pose 2

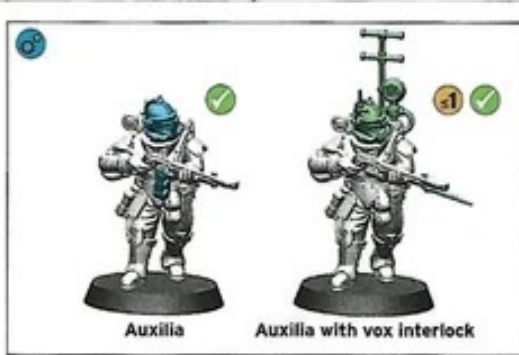
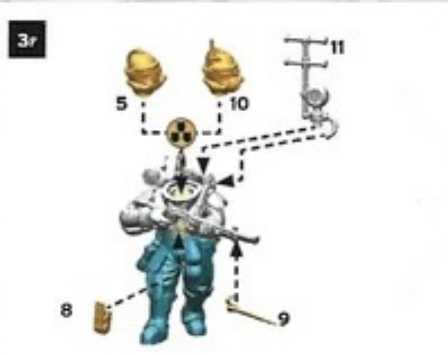
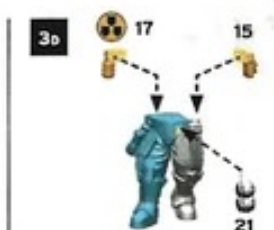
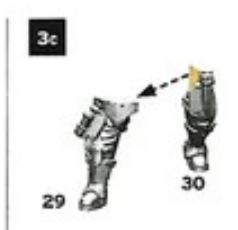
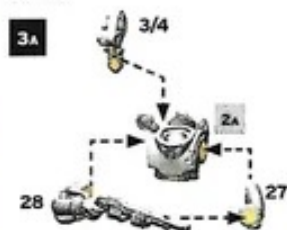

Pose 3

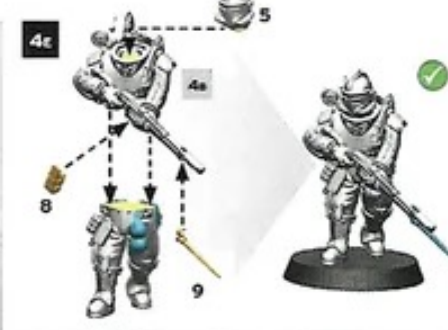
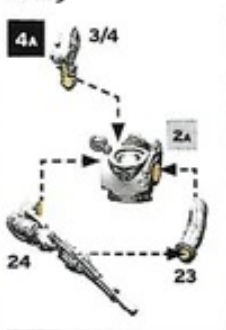

Pose 4

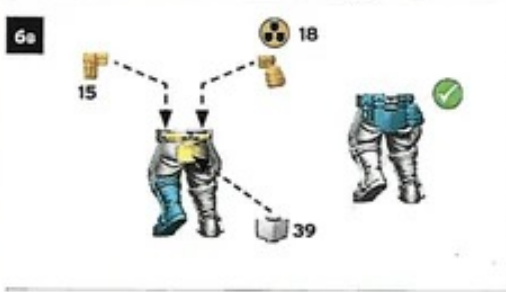
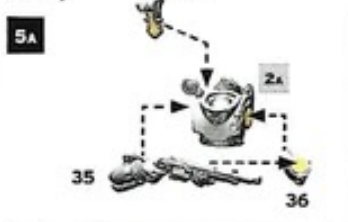

Pose 5

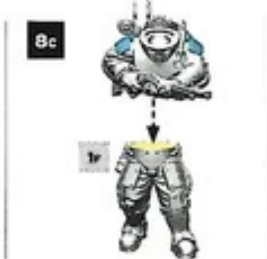
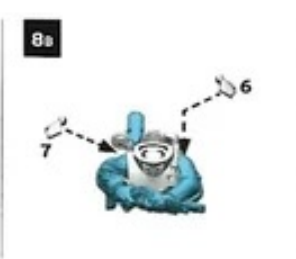
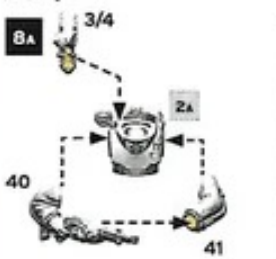

SOLAR AUXILIA TACTICAL COMMAND SECTION

99383005001, 99383005002

AUXILIA CAPTAIN/MARSHAL



AUXILIA COMPANION

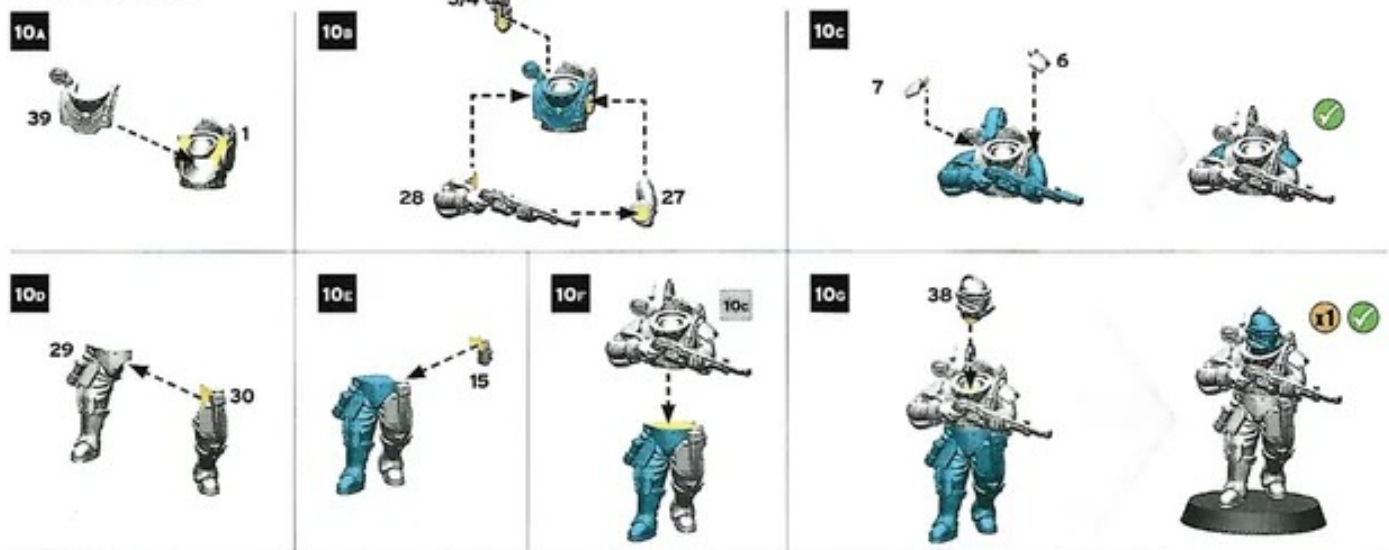

AUXILIA COMPANION WITH AUGURY SCANNER

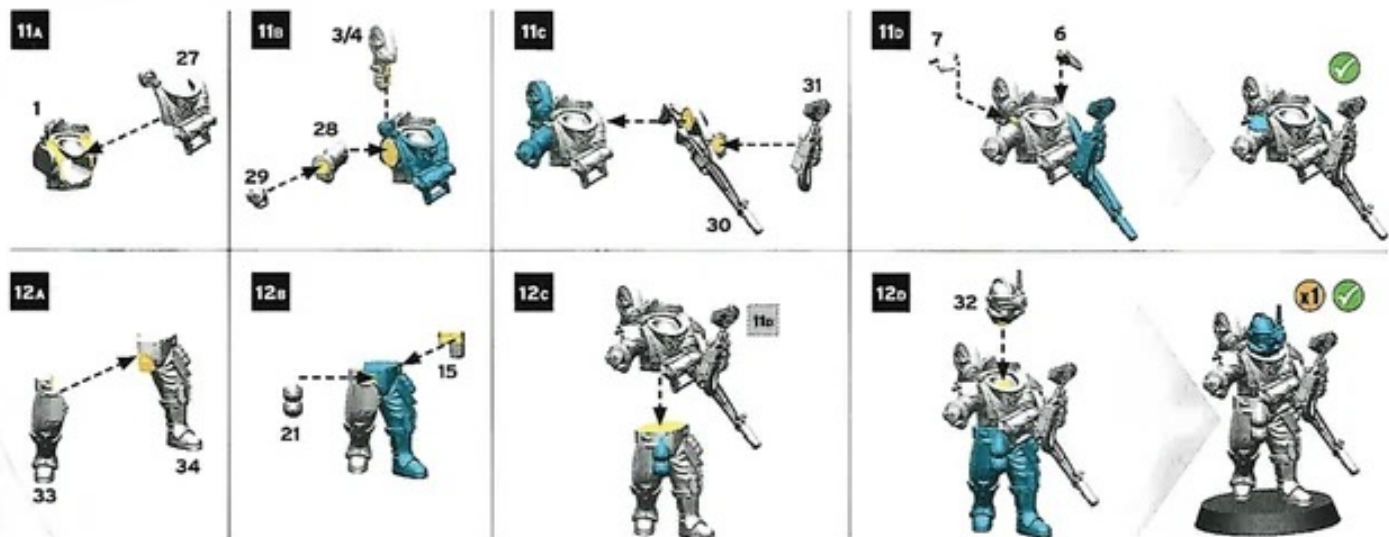

AUXILIA COMPANION WITH COMMAND VOX

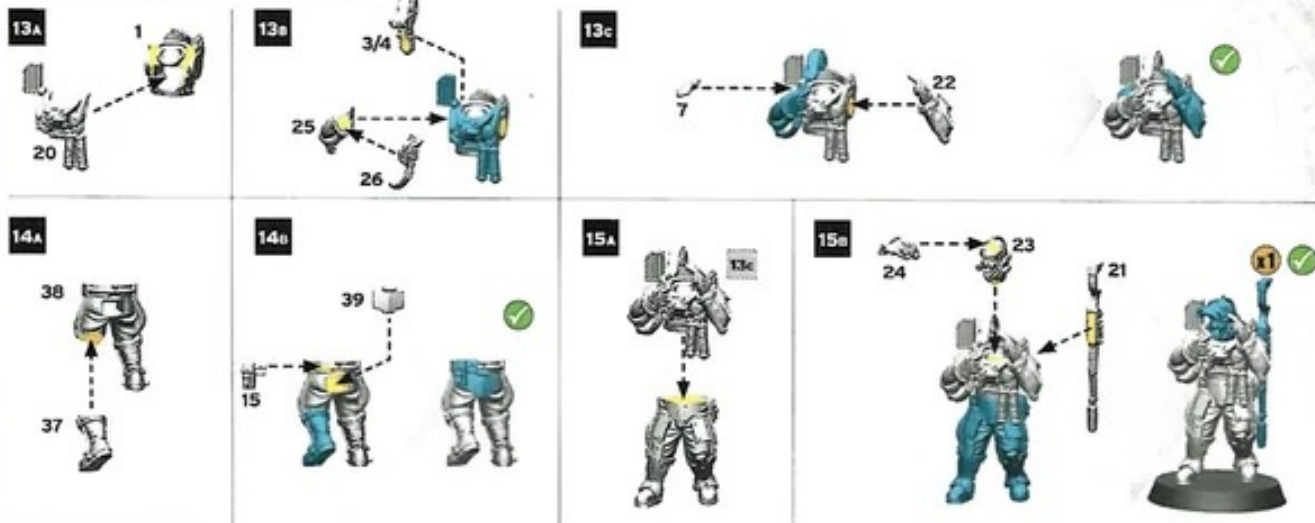

AUXILIA COMPANION WITH COHORTS VEXILLA

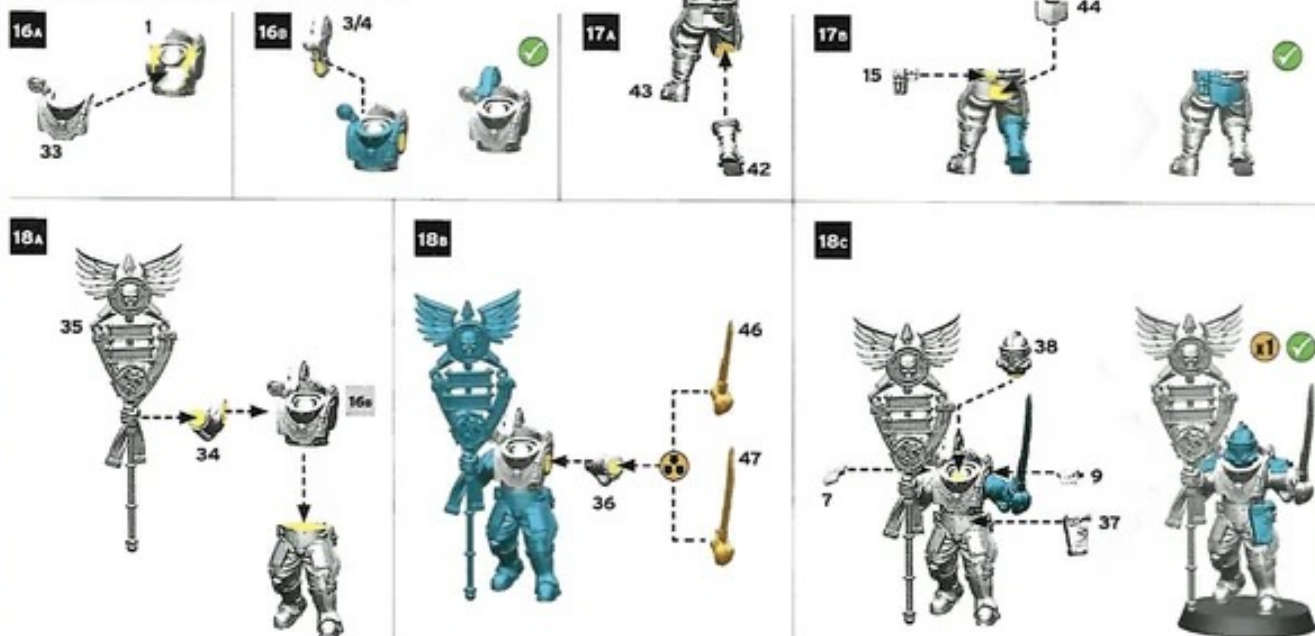

SOLAR AUXILIA LEGATE MARSHAL

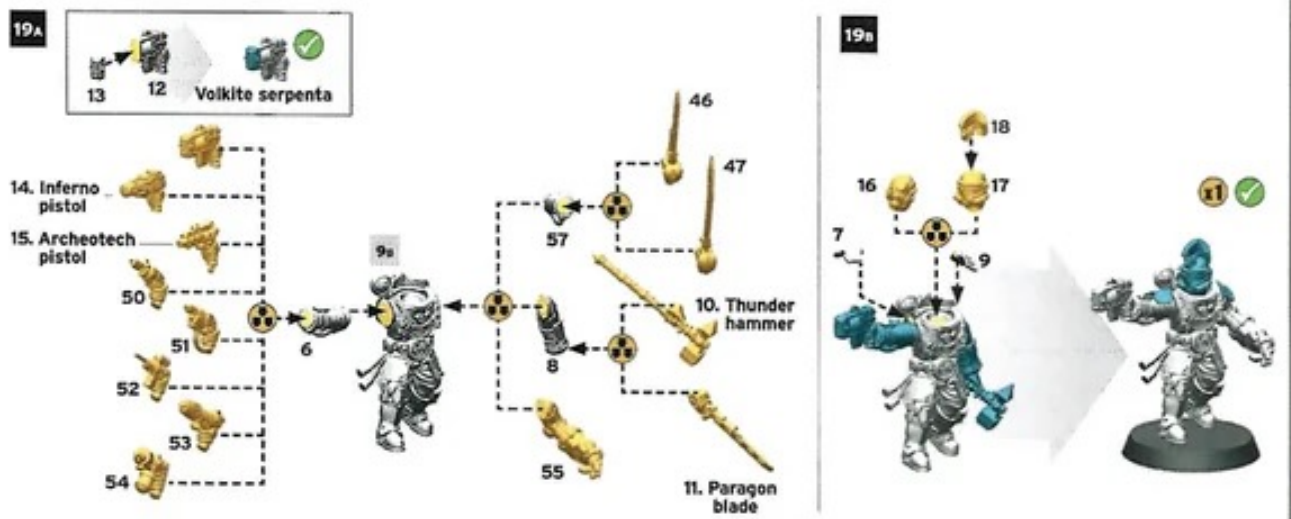

LEMAN RUSS STRIKE TANK

99393005004, 99393005005, 99393005006, 99393005009, 99393005010

20A



20B

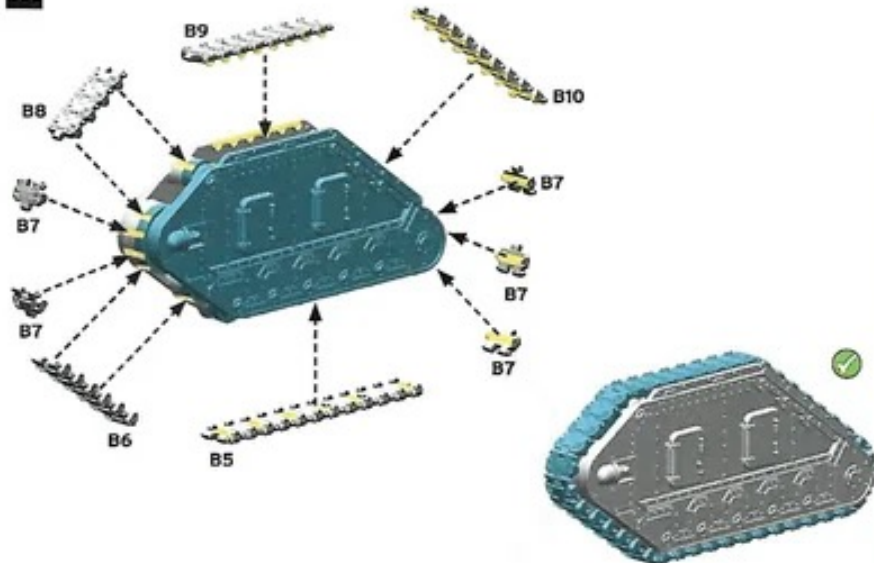

21A



21B

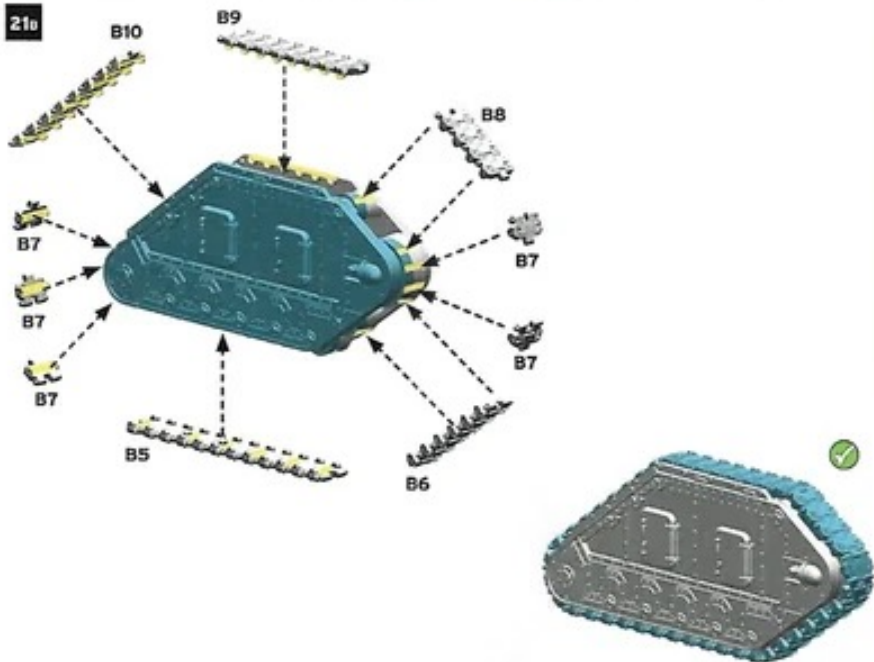

22A



22B

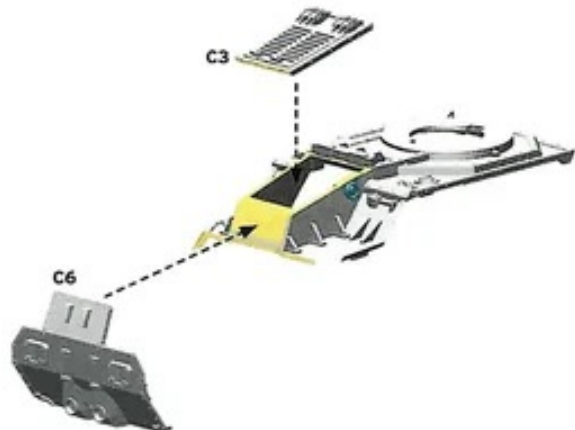

22c

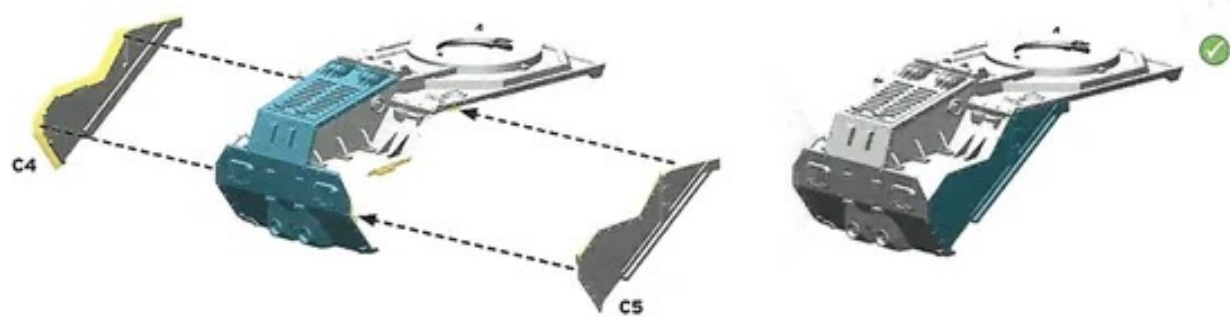

23a



23a

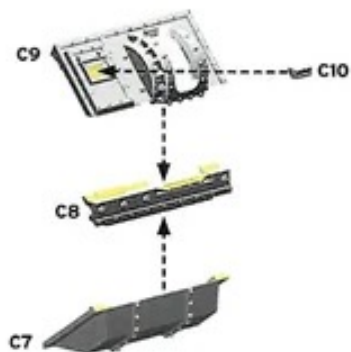

23c

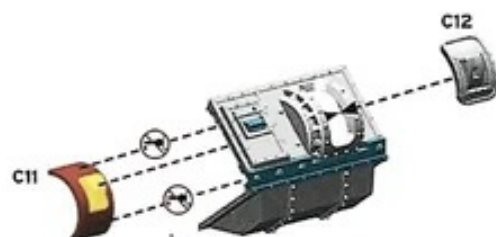

23c

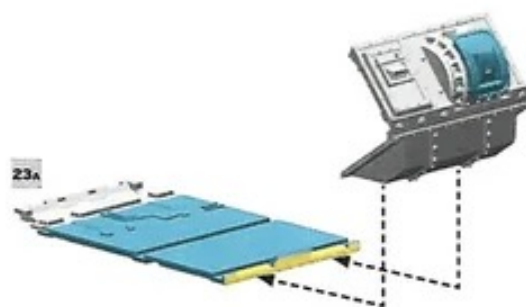

23c

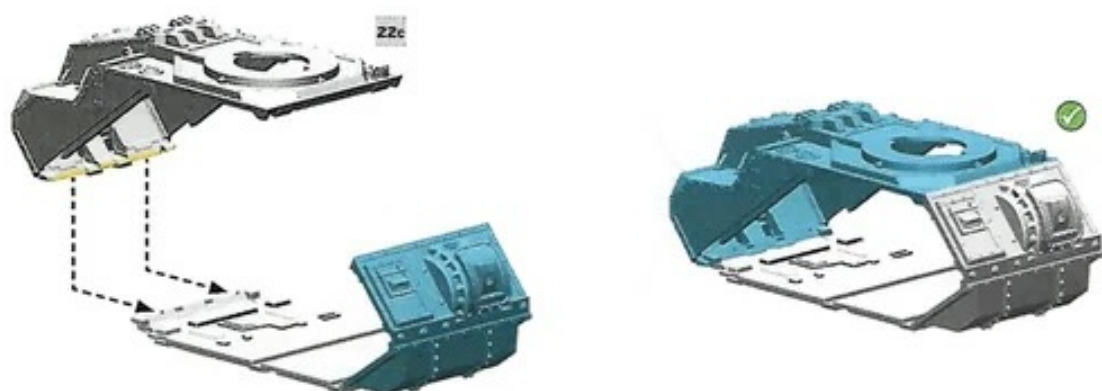

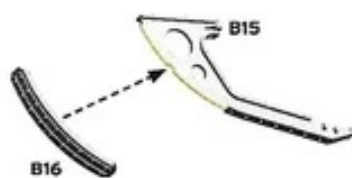
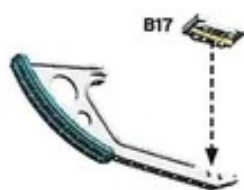
24a 24b 

24c

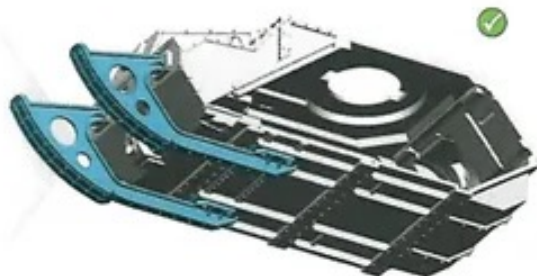
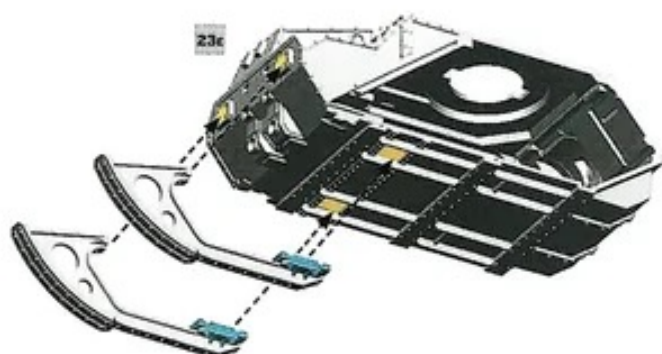

25

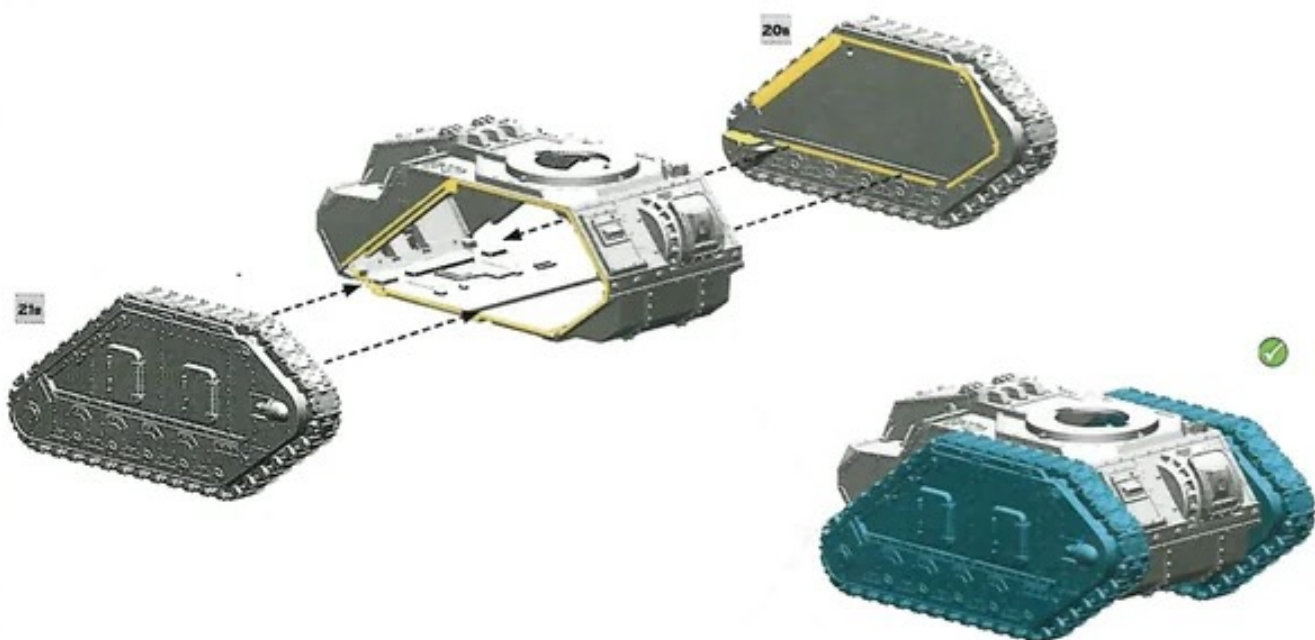

26a



26b



27

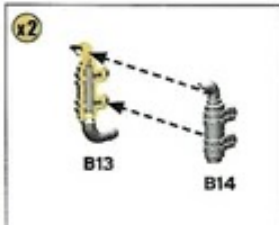

28A

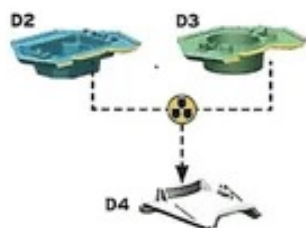

28a



29



30



30



BATTLECANNON



GRAVIS LASCANNON



VANQUISHER BATTLECANNON
with co-axial autocannon



GRAVIS AUTOCANNON

BATTLECANNON

31

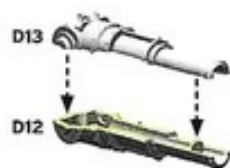

GRAVIS LASCANNON

32

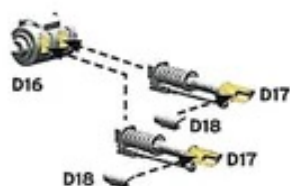

VANQUISHER BATTLECANNON

33

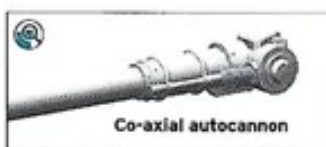
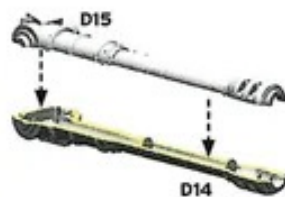

Co-axial autocannon



GRAVIS AUTOCANNON

34

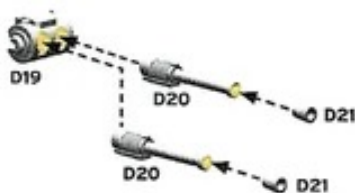

35

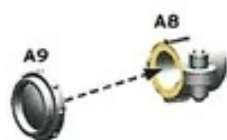

36

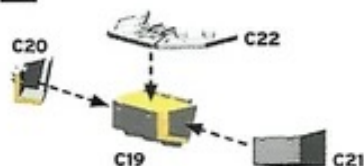

37a



37b



37c



38A



38B

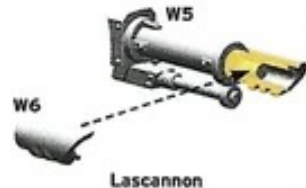
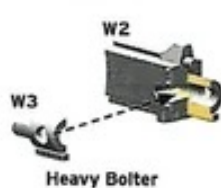
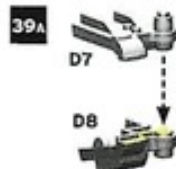

40

- Heavy Bolter
- Lascannon
- W1. Autocannon
- W4. Multi-laser
- W7. Heavy Flamer



CLOSED HATCH

41

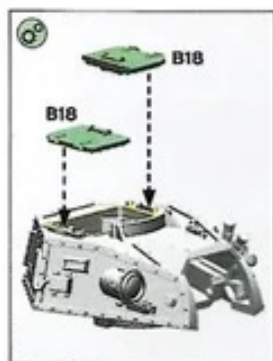

TANK COMMANDER

42a



42b



42c



42d

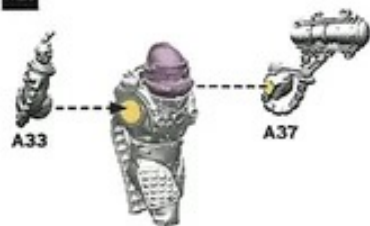

42e

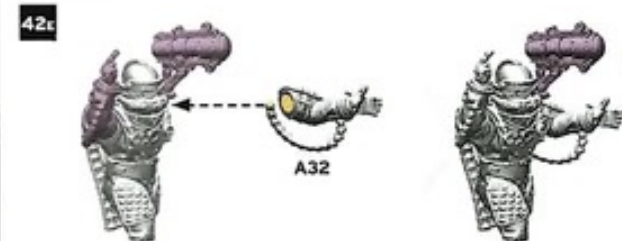

43



44

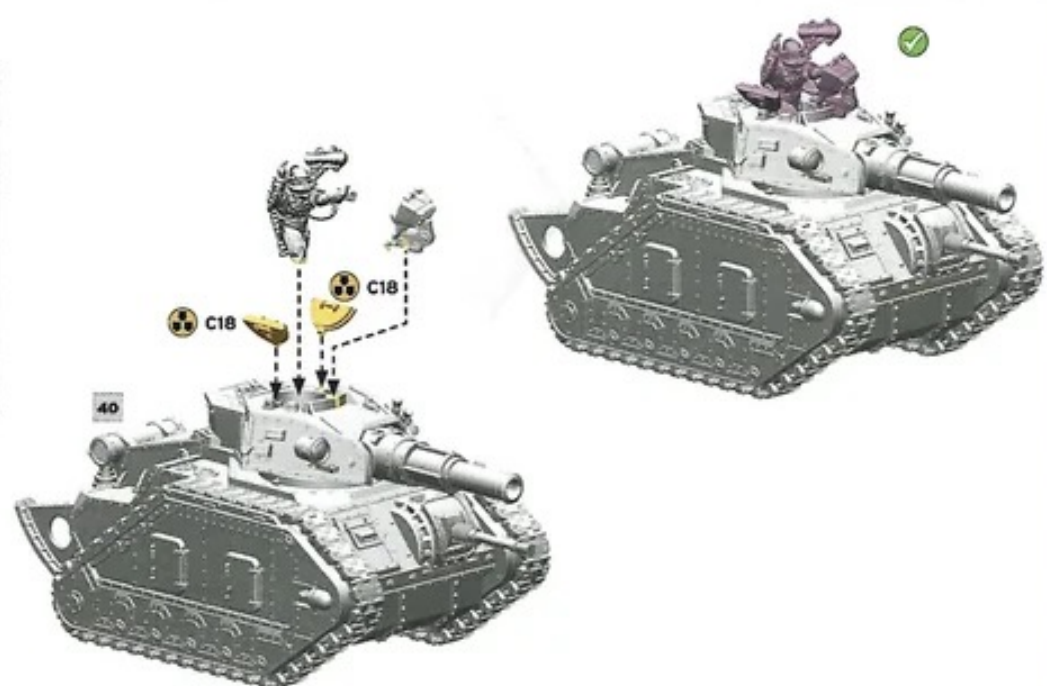

TANK COMMANDER WITH PINTLE WEAPON

45

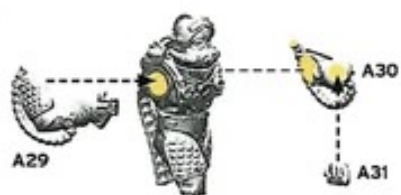

Heavy Flamer



Multi-laser

46

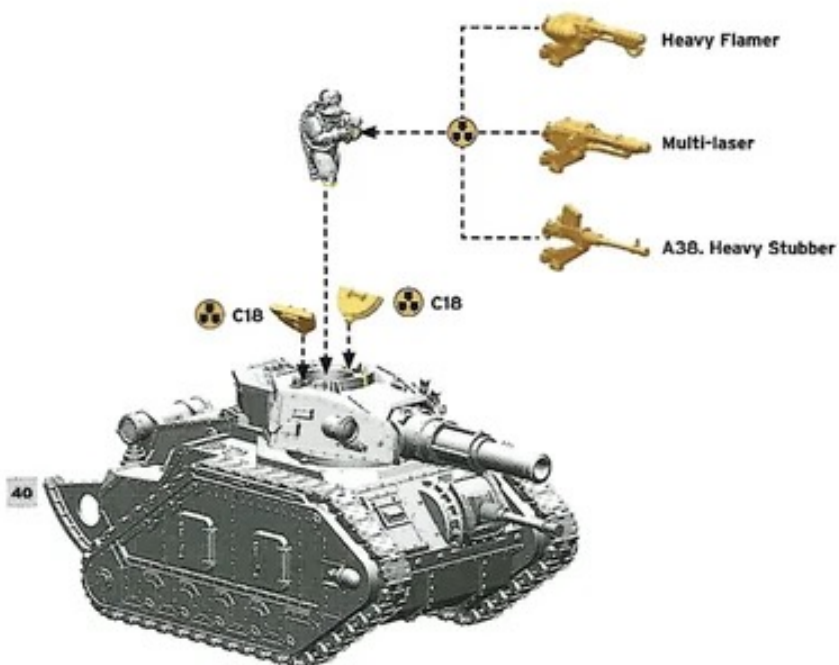
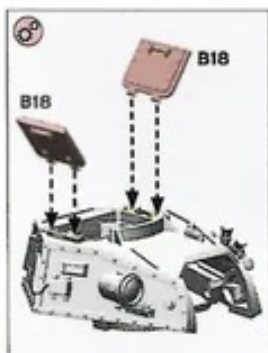

Heavy Flamer

Multi-laser

A38. Heavy Stubber

40



47

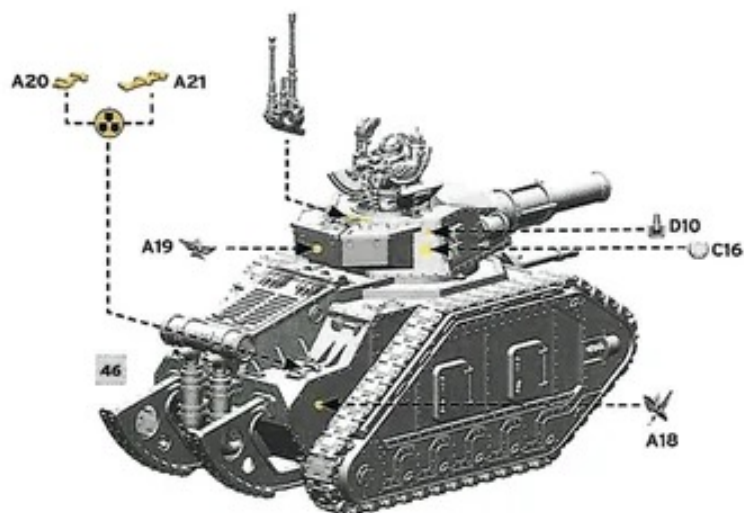
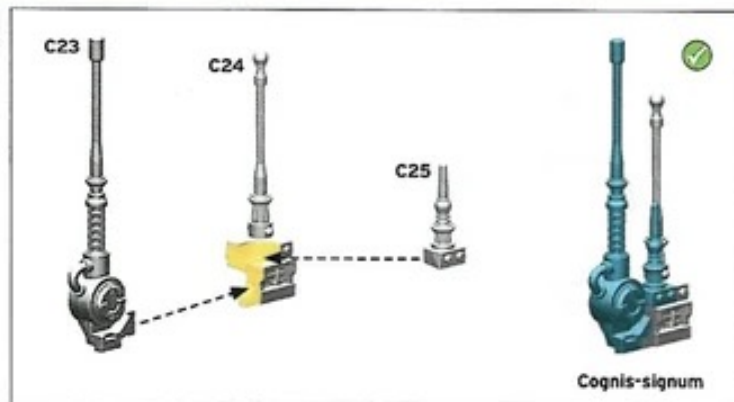

48

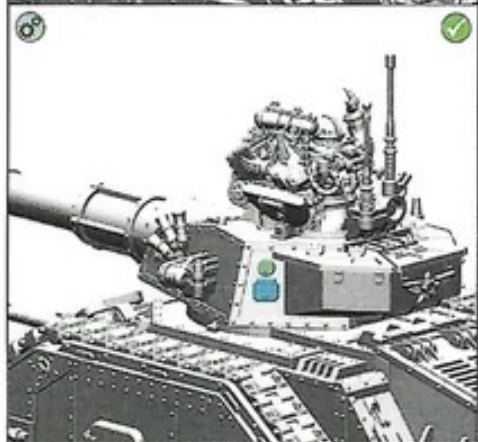
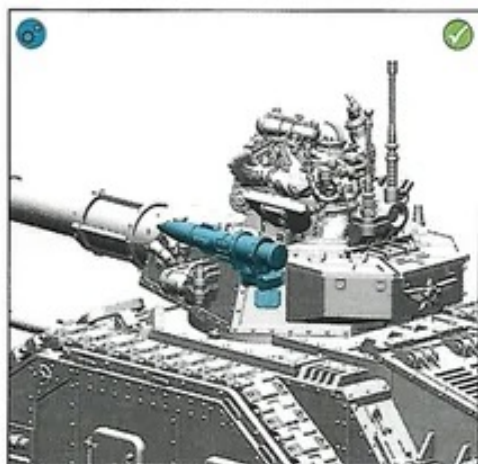
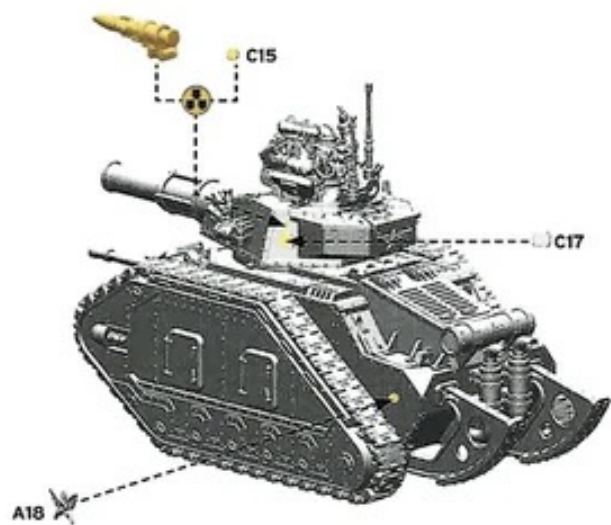
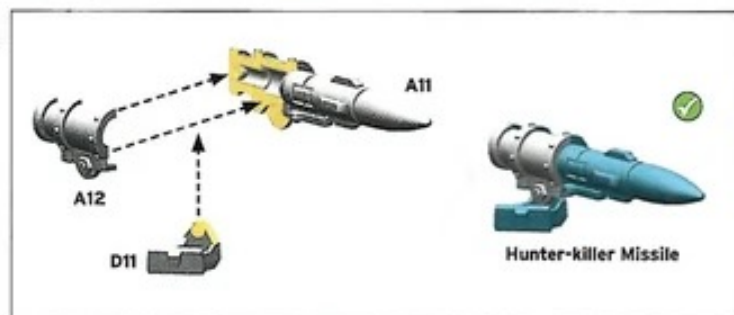

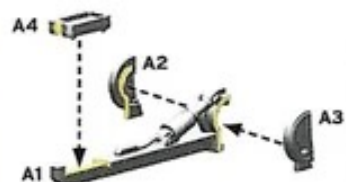
49A 

49B



50A

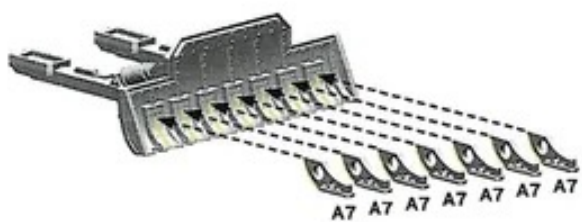

50B

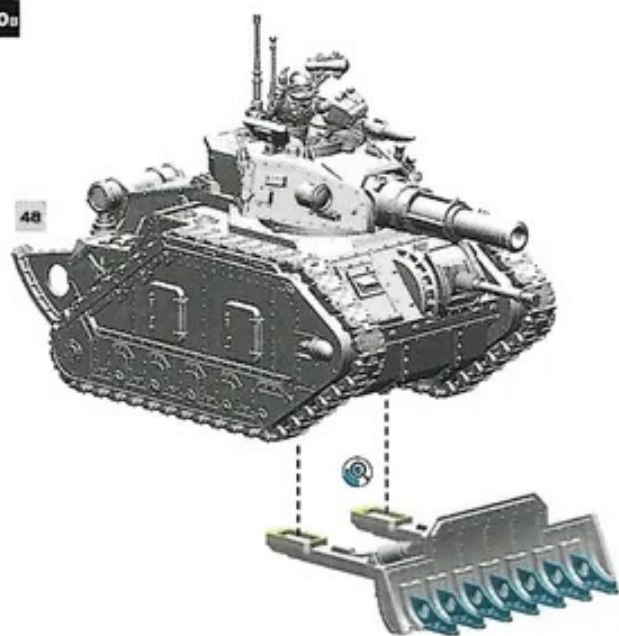

Dozer Blade

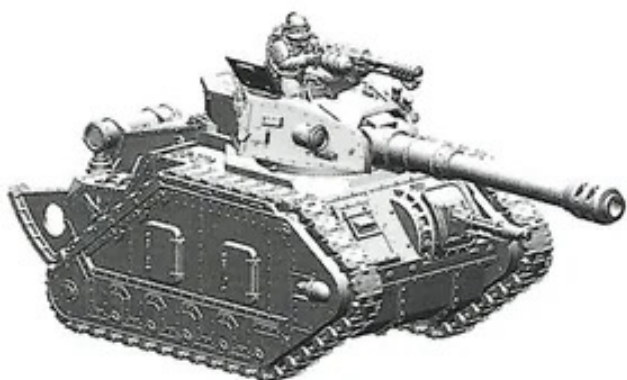
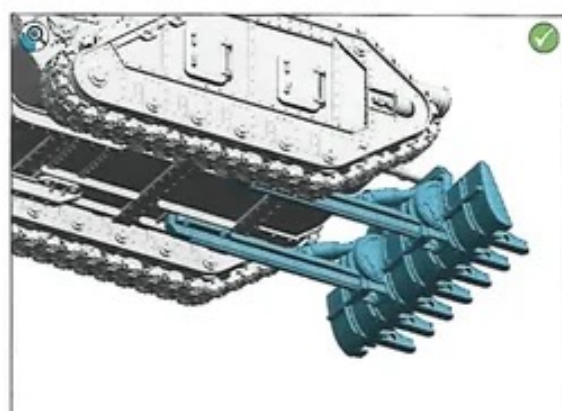

DRACOSAN ARMoured TRANSPORT
99393005007, 99393005001, 99393005002, 99393005009

51a

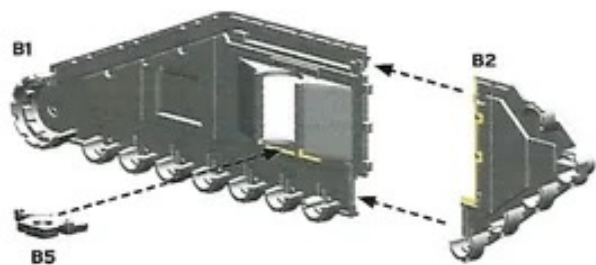

51b

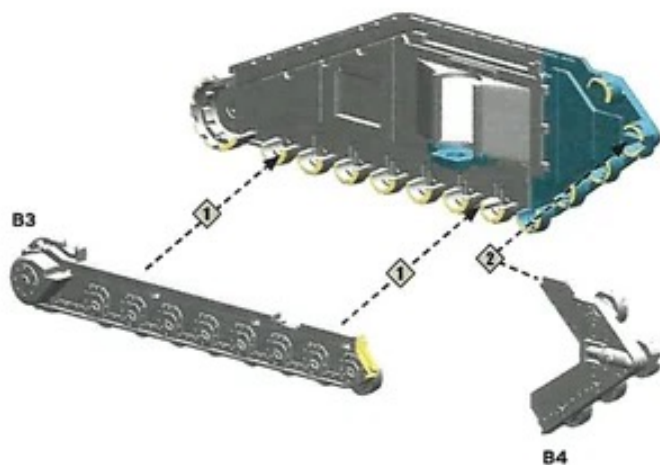

51c

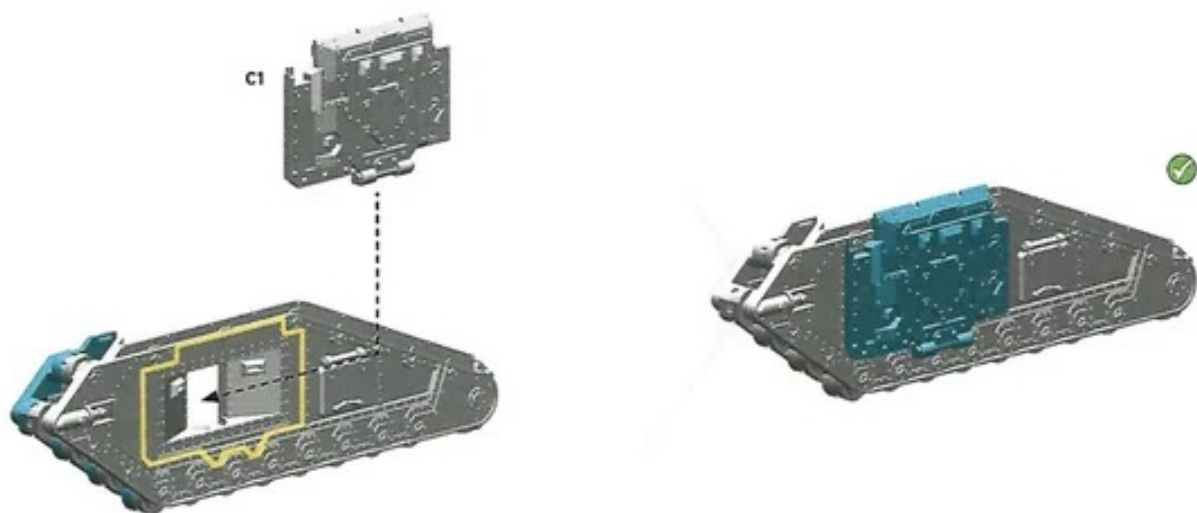

52

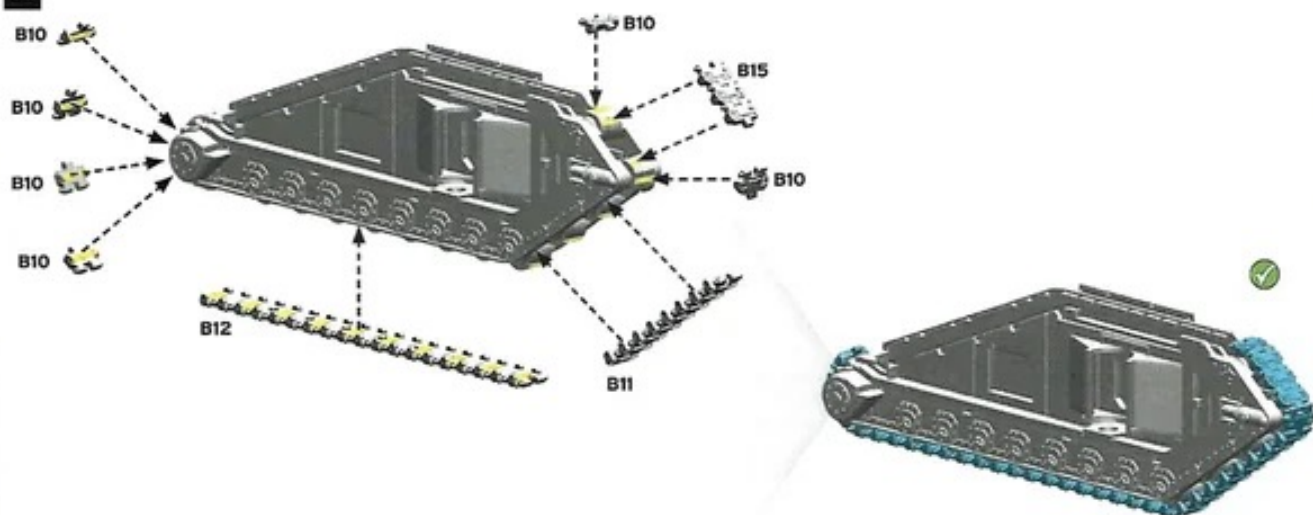

53a

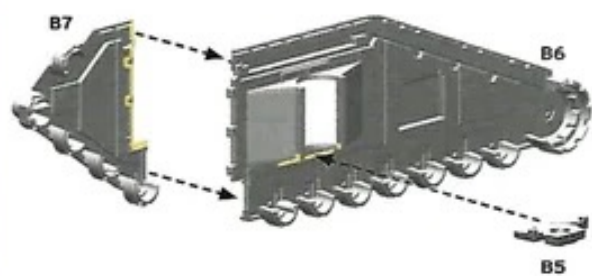

53b

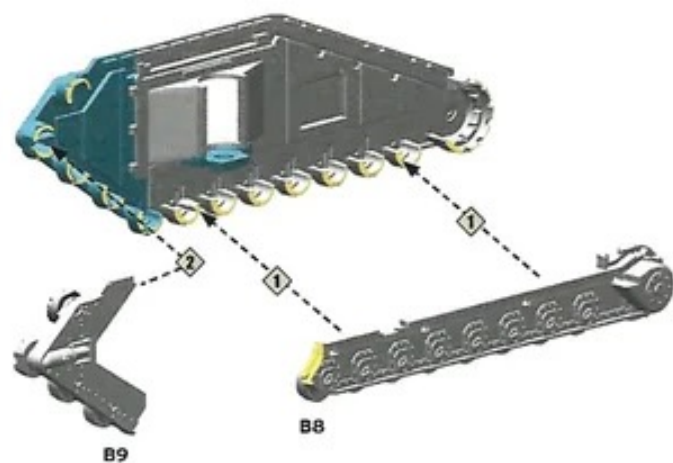

53c

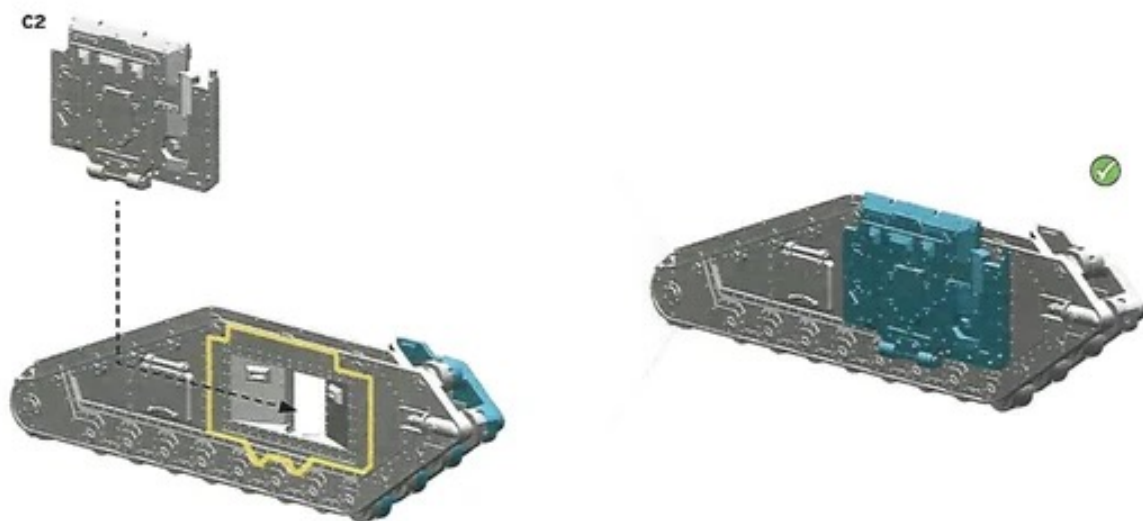

54

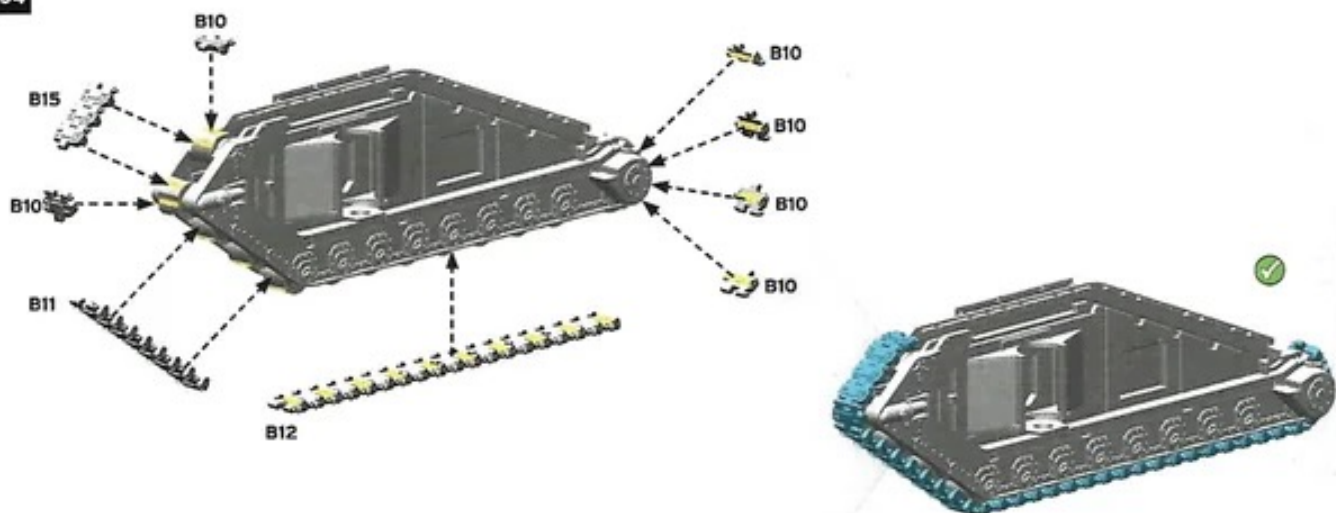

55a

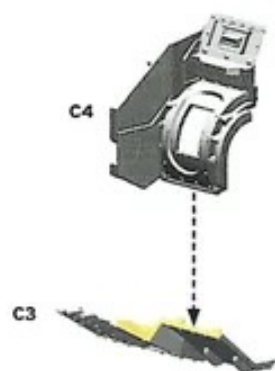

55b

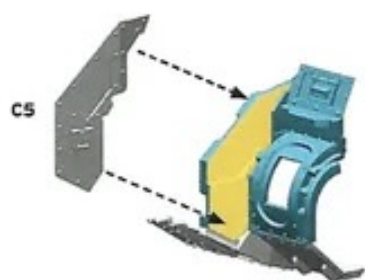

55c

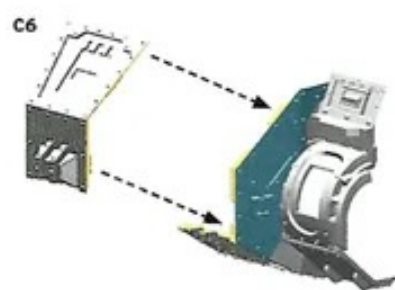

55b

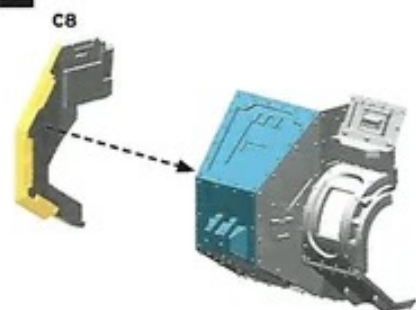

55c

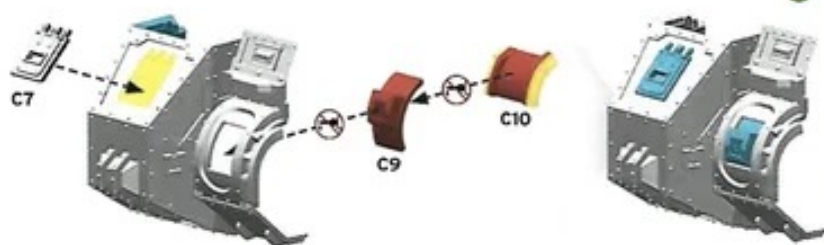

56a

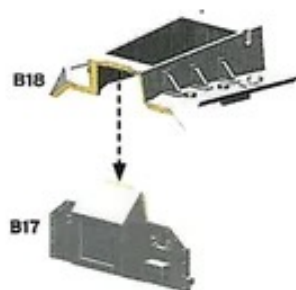

56b

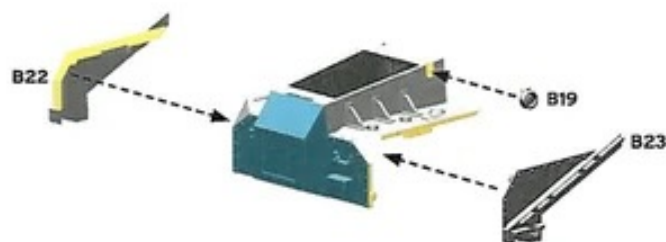

56c

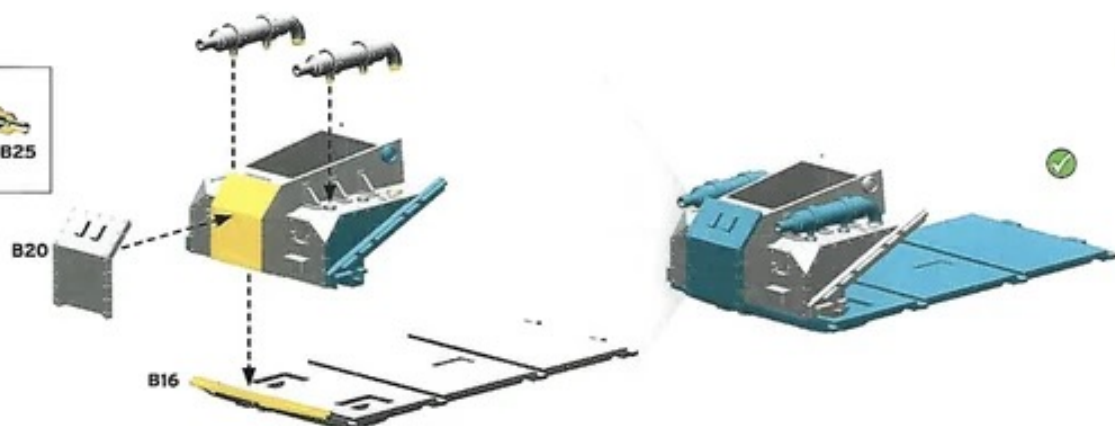
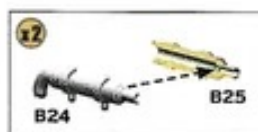

57



58a

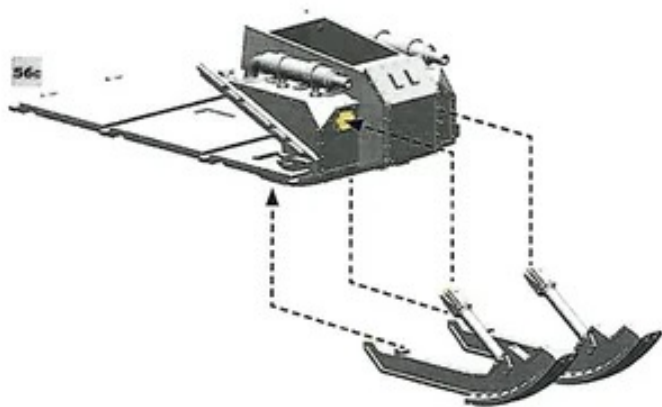

58b

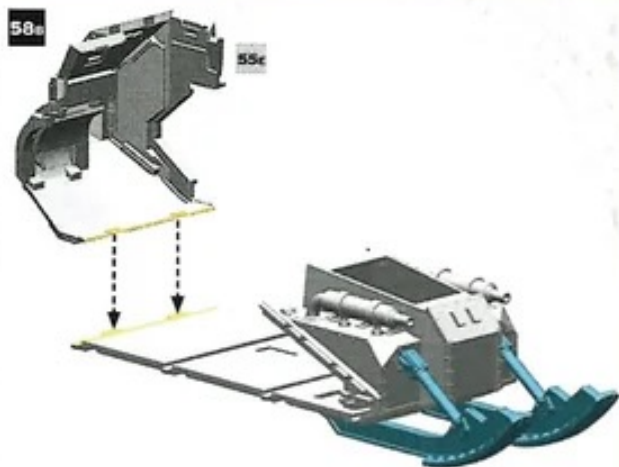

58c

58c

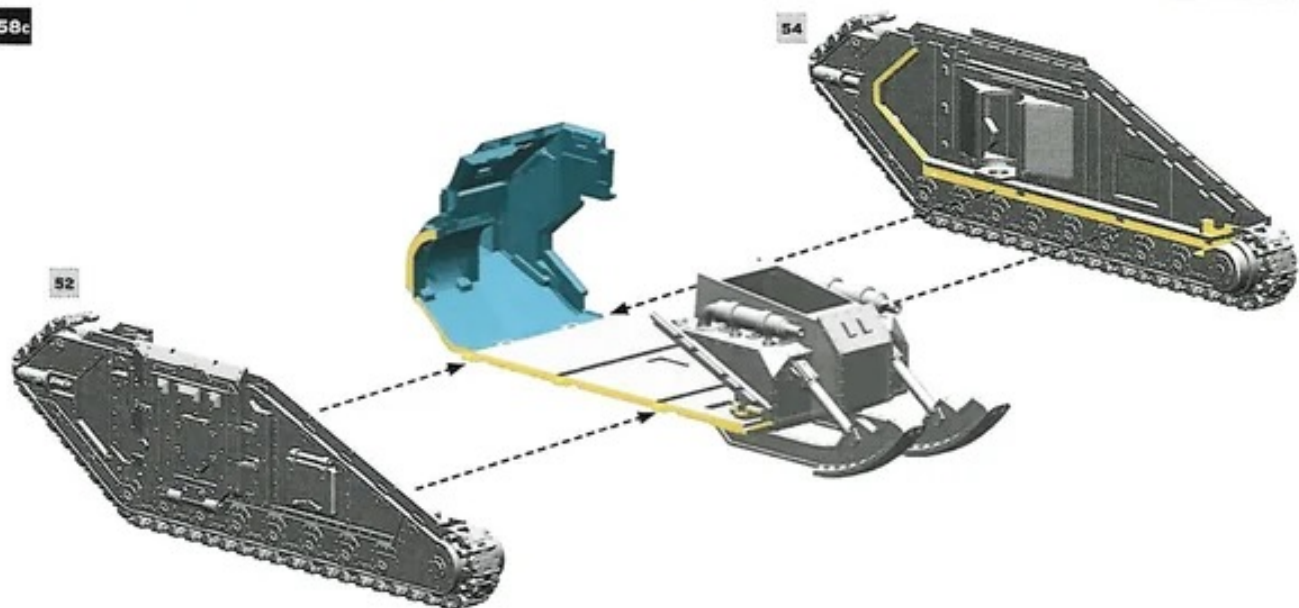

59a

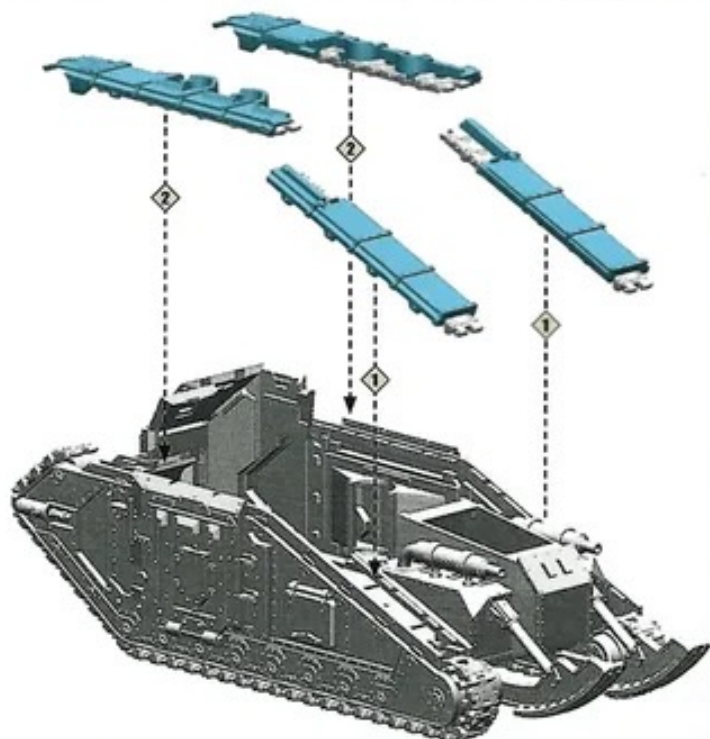
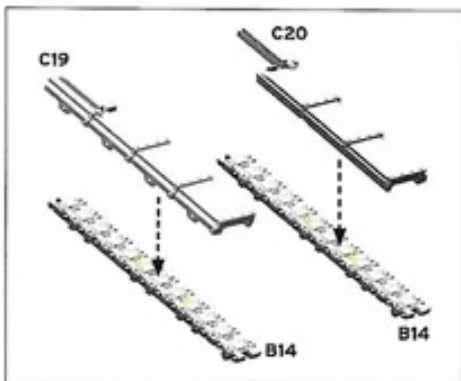
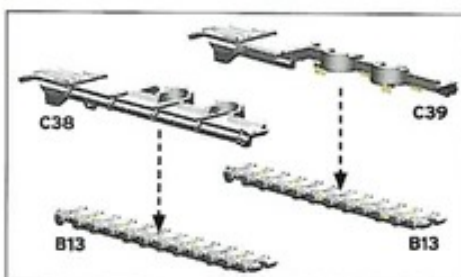

59a

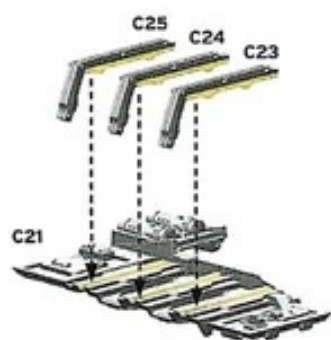

59b



59c

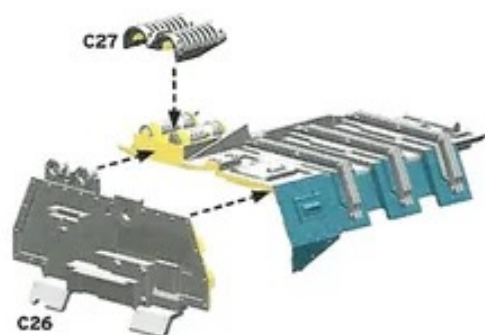

59d

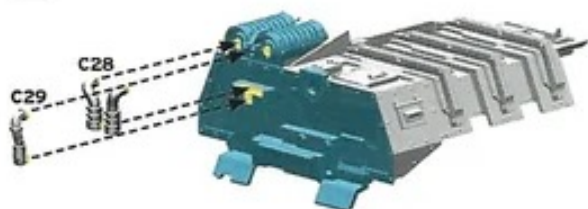

59e

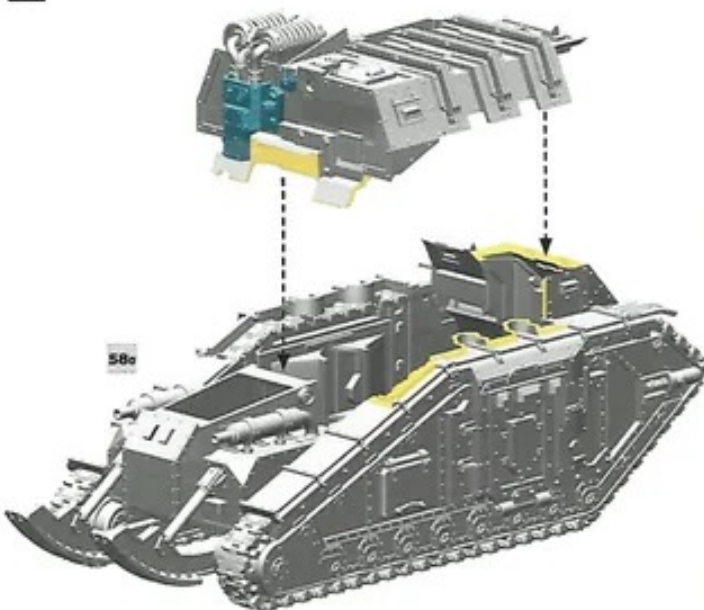

59f

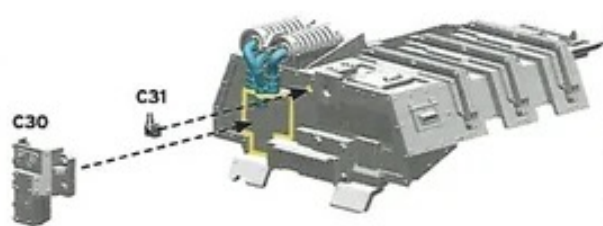

59g

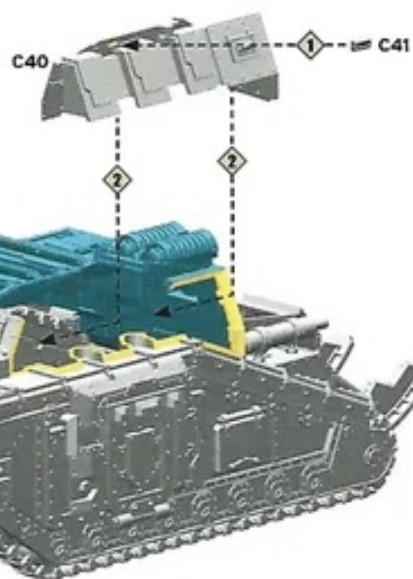

59h

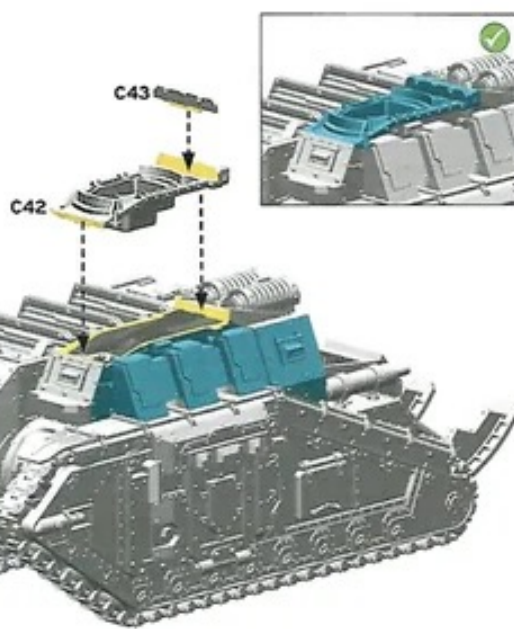

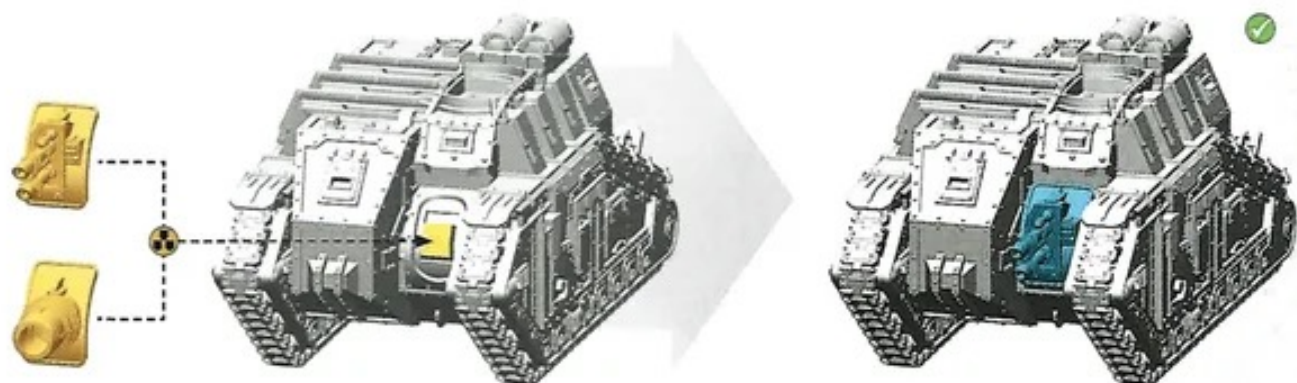
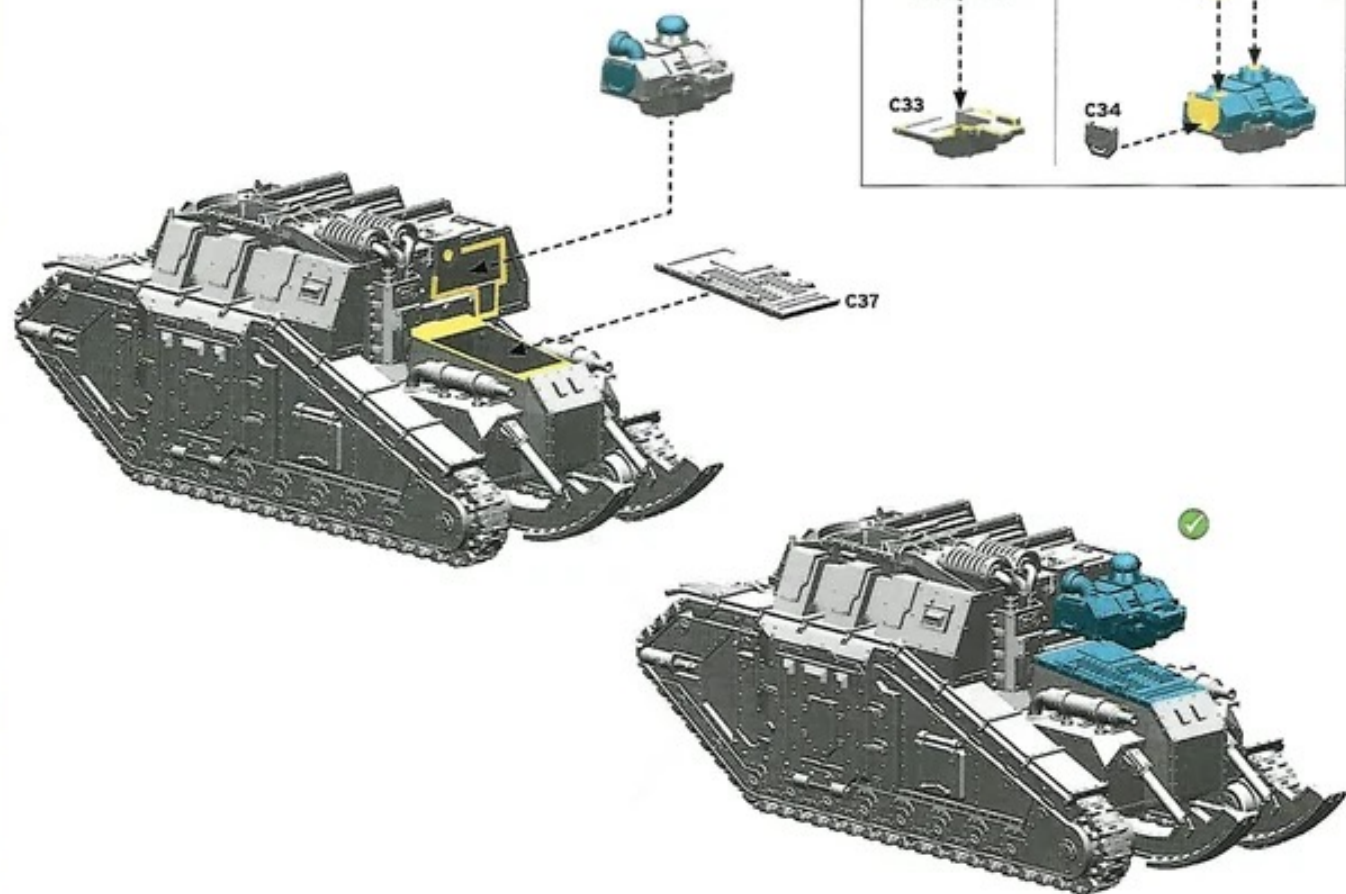

CLOSED HATCH

61

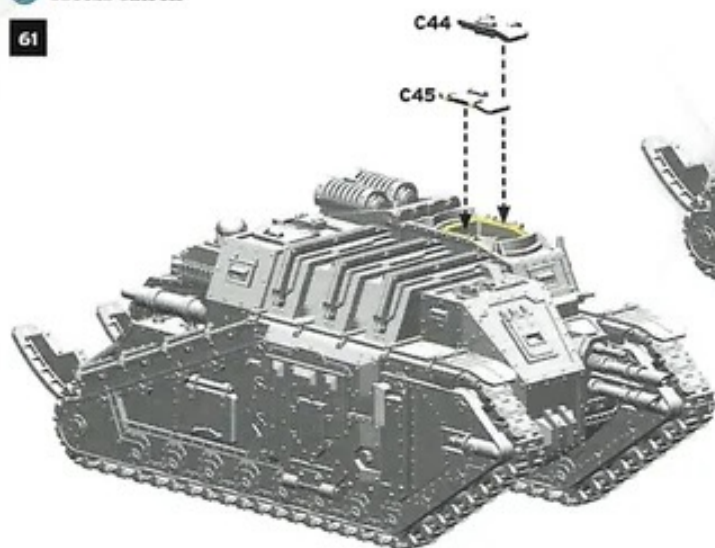

TANK COMMANDER

62a



62b



62c



62d

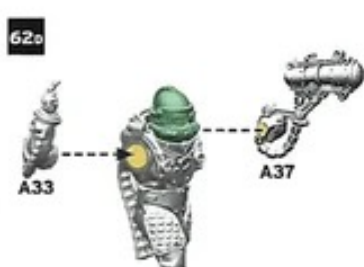

62e

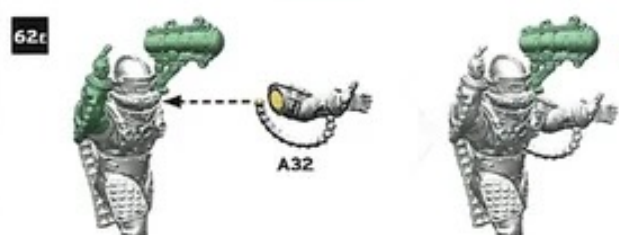

63

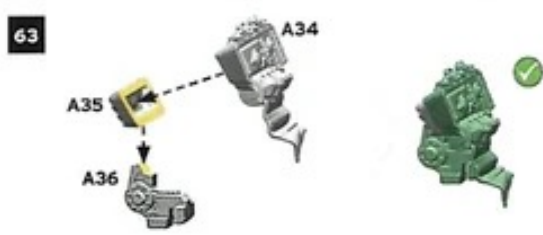

64

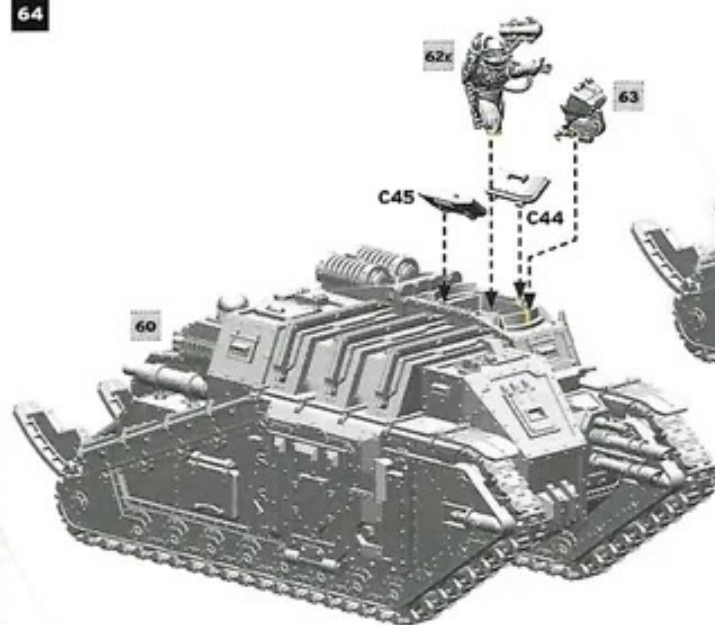

65 TANK COMMANDER WITH PINTLE WEAPON

65



66

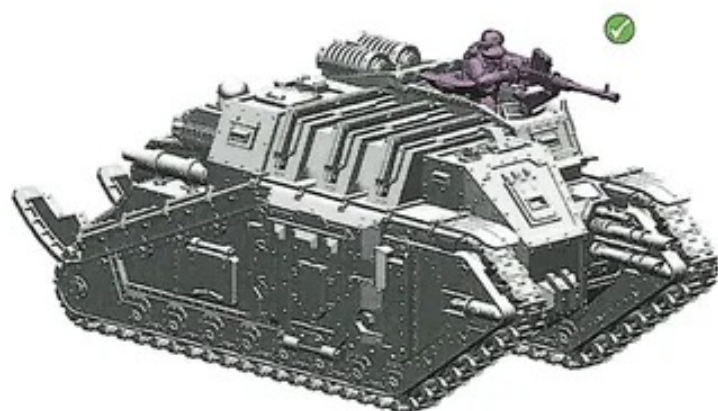
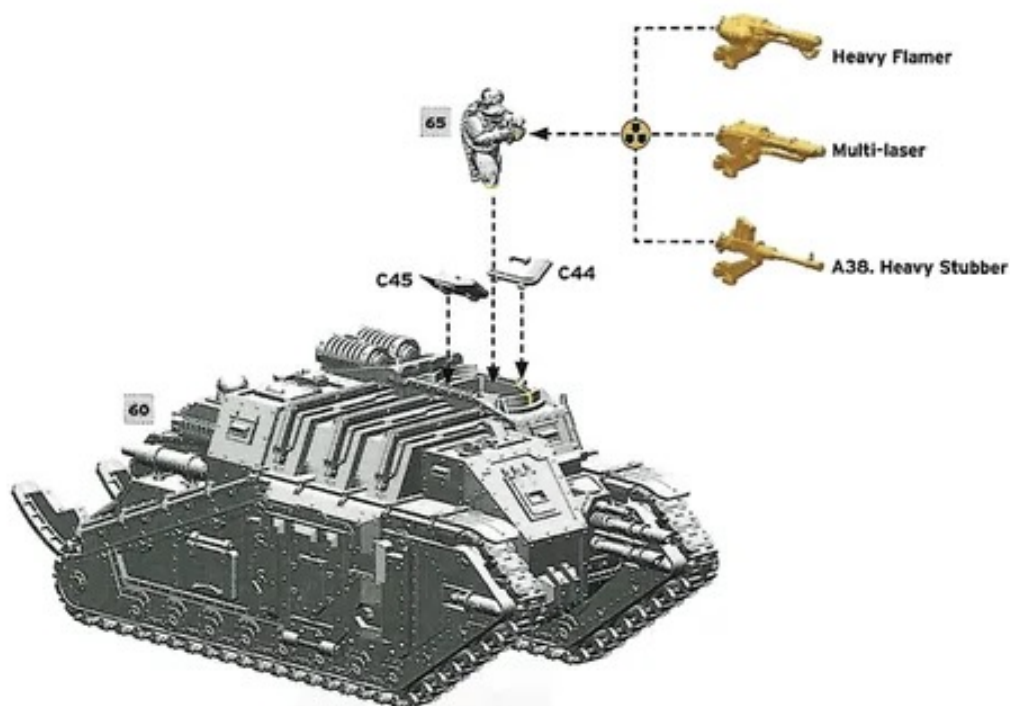

67 HUNTER-KILLER MISSILES



67c



67a

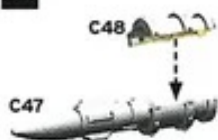

67b



C46

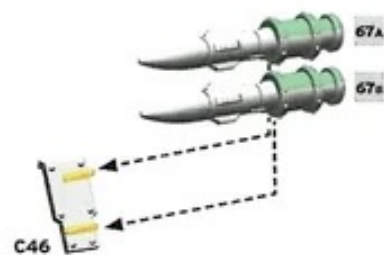

68



69

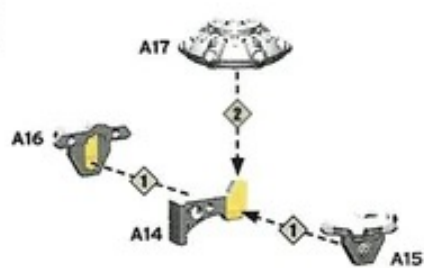

Flare Shield

70

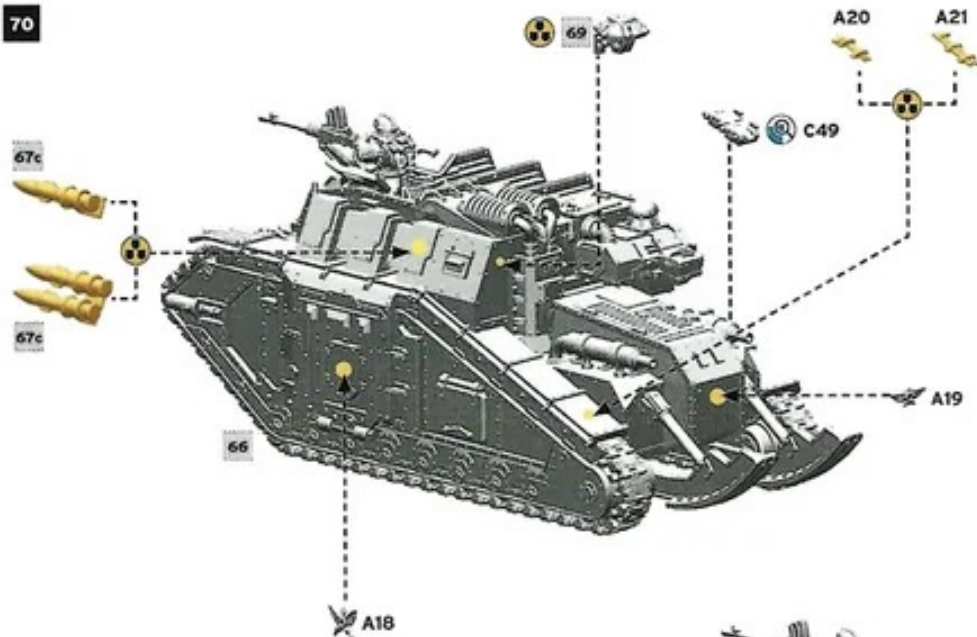

71a **x2**

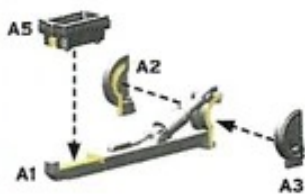

71b



71c



72

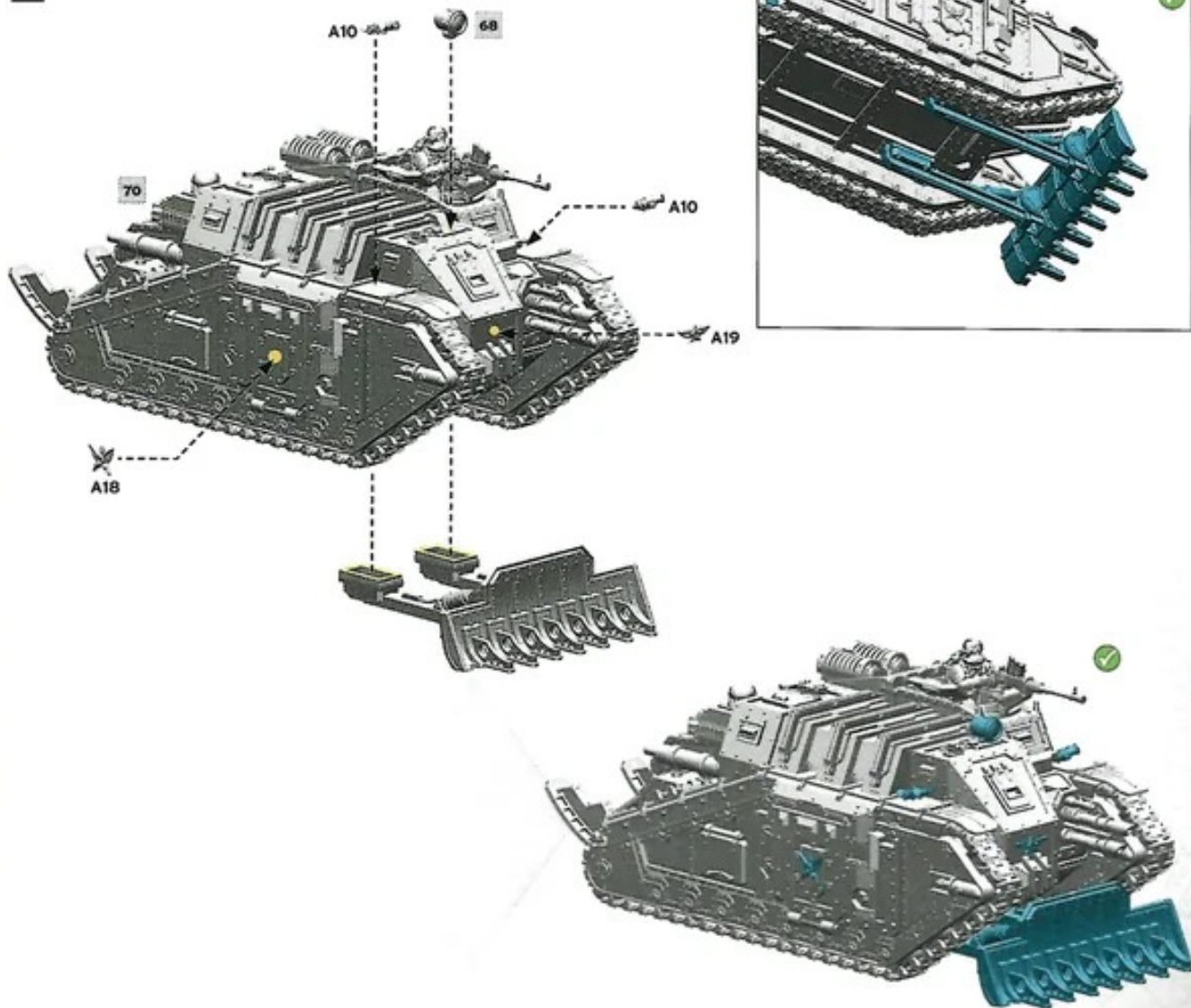

AETHON HEAVY SENTINEL
99393005003

73a

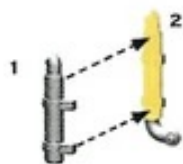

73b

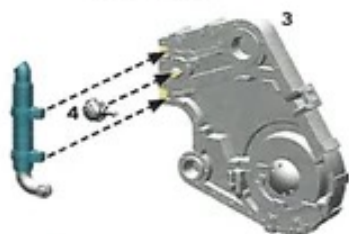

74a

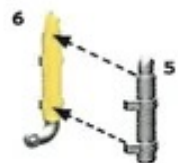

74b

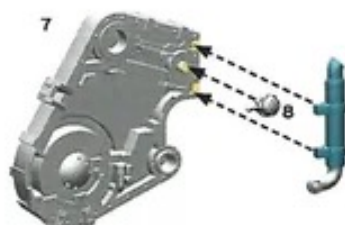

75a



75b



75c



75d



75e

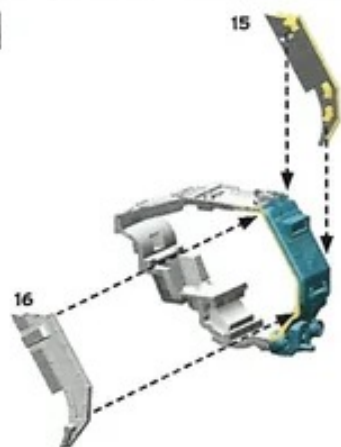

75f



75g

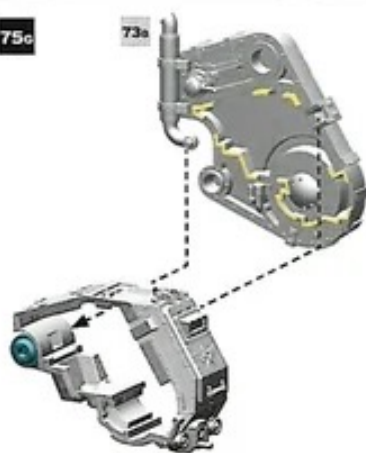

75h

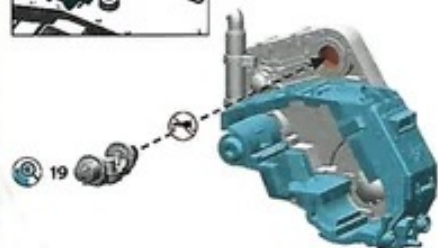

75i

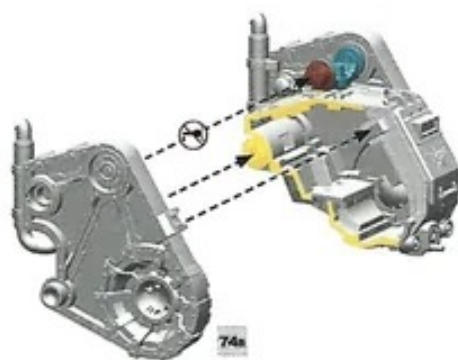



AETHON MISSILE BATTERY



HUNTER-KILLER MISSILES



VOLKITE CULVERIN



AUTOCANNON



HEAVY INCINERATOR



LASCANNON



MULTI-LASER



MELTA LANCE

AETHON MISSILE BATTERY

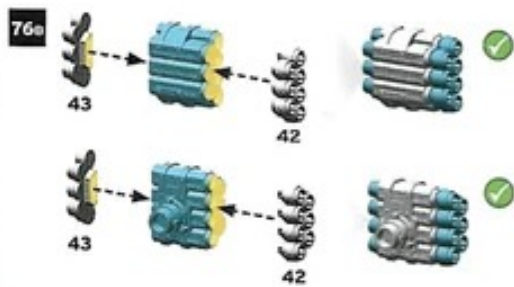
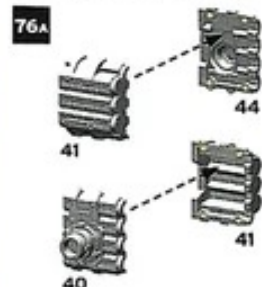

HUNTER-KILLER MISSILES

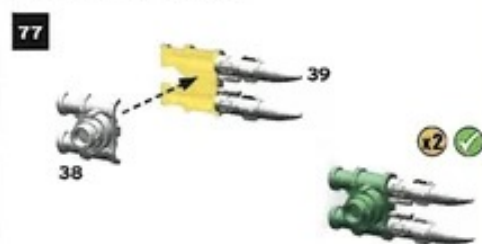

VOLKITE CULVERIN

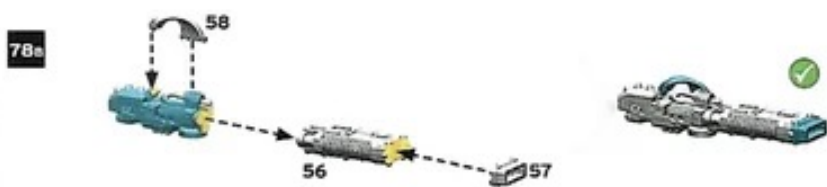

AUTOCANNON

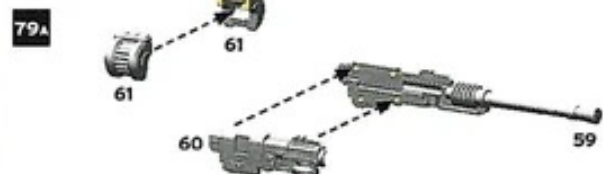

HEAVY INCINERATOR

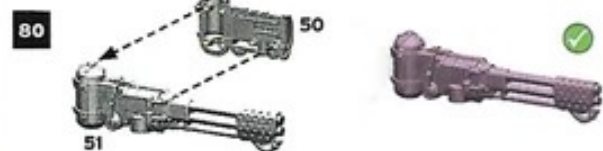

MULTI-LASER



83

- Remove to allow for different poses
- Couper pour permettre d'autres poses
- Cortar para crear diferentes posiciones
- Für andere Posen abtrennen
- Rimuovi per ottenere pose differenti
- ボーンを切り取る場合は取り外す
- 移除部件以取下不同形态



84a



84b



84c

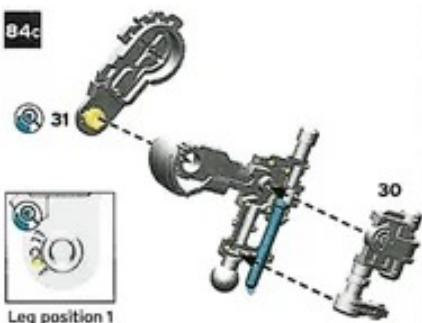

84d



84e

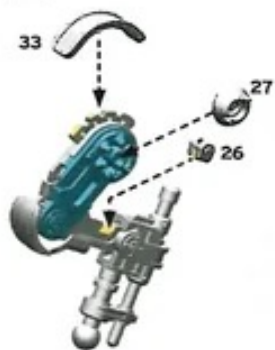

85



Leg position 1

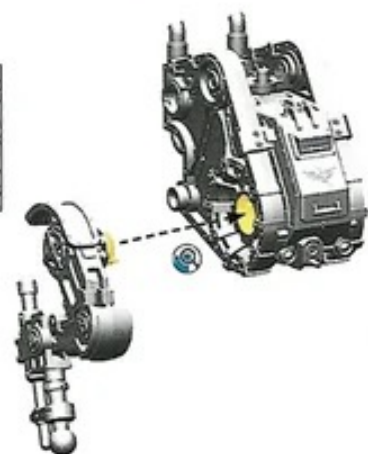

86a



86b

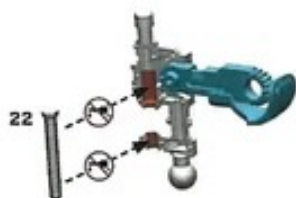

86c



Leg position 2



86d



86e



87A



Leg position 2

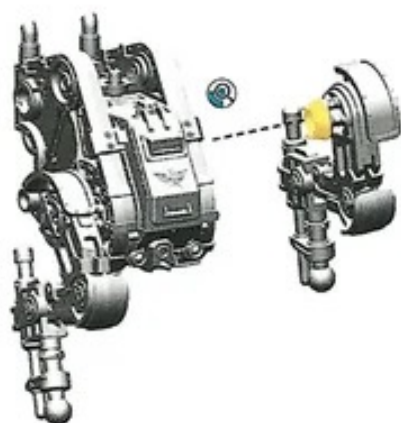

87B

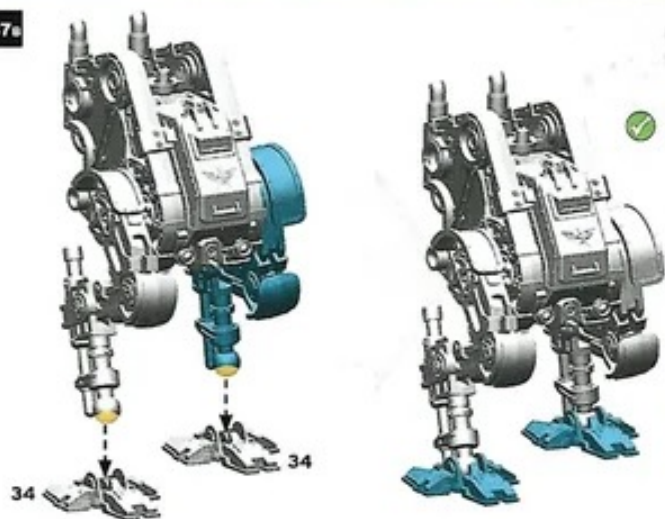

88

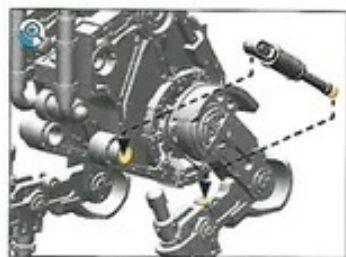
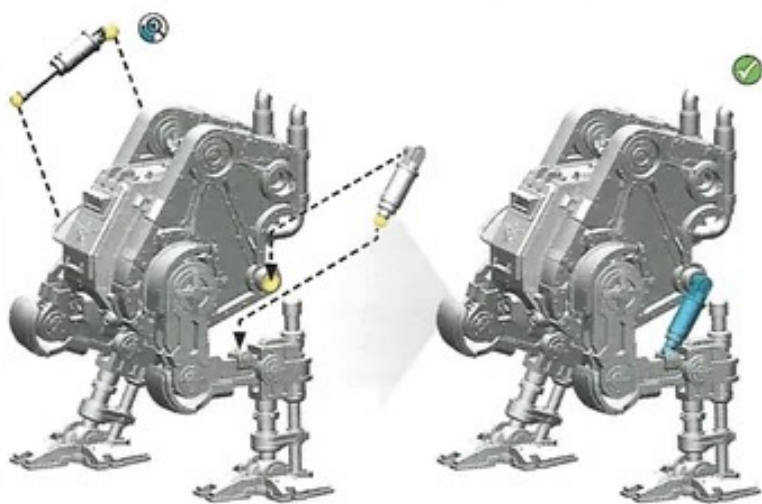

89

