



Free Downloads of Build Instructions,
Assembly Booklets & How To Guides

BuildInstructions.com

WARHAMMER 40.000

SENTINEL

WÄCHTER
ЧАСОВОЙ
センチネル
哨兵



READ THIS FIRST | À LIRE EN PRIORITÉ | BITTE BEACHTE | LEE ESTO PRIMERO | LEGGI PRIMA QUESTO
В ПЕРВУЮ ОЧЕРЕДЬ ПРОЧИТАЙТЕ ЭТО | 最初にお読みください。 | 请先阅读

ENG BEFORE ASSEMBLING YOUR MINIATURES, PLEASE READ THROUGH THE INSTRUCTIONS IN THIS BOOKLET CAREFULLY. A pair of plastic cutters is required to remove the plastic components in this kit from their frame. We advise using a mouldline scraping tool to clean up the parts. To assemble your model you will need plastic glue. Games Workshop sells Citadel Fine Detail Cutters, Citadel Mouldline Remover and Citadel Plastic Glue, but does not recommend these products for use by children under the age of 16 without adult supervision.

FRE AVANT D'ASSEMBLER VOS FIGURINES, VEUILLEZ LIRE ATTENTIVEMENT LES INSTRUCTIONS DE CE LIVRET. Une pince coupante est requise pour détacher chaque élément de sa grappe. Nous vous recommandons l'utilisation d'un grattoir pour ébarber les éléments. Pour l'assemblage, vous aurez également besoin de colle plastique. Games Workshop commercialise les Pinces de Précision Citadel, l'Ébarboir Citadel et la Colle Plastique Citadel, mais n'en recommande pas l'utilisation pour des enfants de moins de 16 ans sans la supervision d'un adulte.

SPA POR FAVOR, LEE CUIDADOSAMENTE ESTE LIBRETO DE INSTRUCCIONES ANTES DE EMPEZAR A MONTAR LAS MINIATURAS. Te harán falta unas tenazas para plástico a fin de separar las piezas de la matriz. También aconsejamos una herramienta para rebabas a fin de limpiar cada pieza. Para montar la miniatura necesitarás pegamento para plástico. Games Workshop vende Tenazas Citadel, Herramientas para rebabas Citadel y Pegamento para plástico Citadel, pero no recomienda estos productos a menores de 16 años sin la supervisión de un adulto.

GER VOR DEM ZUSAMMENBAU DER MINIATUREN BITTE DIE ANWEISUNGEN IN DIESER ANLEITUNG AUFMERKSAM DURCHLESEN. Du benötigst einen Kunststoffseitenschneider, um die Kunststoffbauteile aus dem Gussrahmen herauszutrennen, und Kunststoffkleber, um die Miniatur zusammenzubauen. Außerdem empfehlen wir, die Bauteile vorher mit einem Gussgratentferner zu säubern. Games Workshop bietet Präzisions-Kunststoffseitenschneider von Citadel sowie Citadel-Kunststoffkleber an, empfiehlt aber, dass Kinder unter 16 Jahren diese nur unter Aufsicht eines Erwachsenen benutzen.

ITA PRIMA DI ASSEMBLARE LE TUE MINIATURE LEGGI ATTENTAMENTE TUTTE LE ISTRUZIONI DI QUESTO LIBRETTO. Sono necessarie un paio di tronchesine per plastica per staccare i componenti dai loro sprue. Consigliamo di usare un attrezzo apposito per pulire i componenti. Per assemblare il modello avrai bisogno di colla per plastica. Games Workshop vende Tronchesine di precisione Citadel, Attrezzo per ripulire Citadel e Colla per plastica Citadel, ma non consiglia questi prodotti ad un pubblico minore di 16 anni senza la supervisione di un adulto.

RUS Кусачки для пластика нужны для снятия пластиковых элементов набора с рамок. Для зачистки деталей рекомендуем использовать инструмент для удаления дефектов. Для сборки модели вам понадобится клей для пластика. Компания Games Workshop предоставляет кусачки «Citadel Fine Detail Cutters», инструмент для удаления дефектов «Citadel Mouldline Remover» и клей для пластика «Citadel Plastic Glue», но не рекомендует эти изделия к использованию детьми младше 16 лет без надзора взрослых.

日本語 本キット内のフレームからプラスチックパーツを切り離すためには、ニッパーが必要です。パーツのモールドを平らにするには、専用ツールの使用をお勧めいたします。本キットの組み立てには、プラ用接着剤が必要です。ゲームズワークショップはシタデル・ニッパー、プラ用接着剤、シタデル・モールドラインリムーバーを販売しておりますが、16歳以下の子供が大人の監督なしにこれらの道具を使用されることをお勧めしません。

中文 你需要一把模型剪将塑料部件从板件上剪下来。我们建议使用分模线刮刀来处理零件。组装时你还需要用到模型胶水。你可以从 Games Workshop 处购买到 Citadel Fine Detail Cutter 模型剪、Citadel Mouldline Remover 分模线刮刀和 Citadel Plastic Glue 模型胶，但 16 岁以下儿童不得在没有成年人监护的情况下使用这些产品。

- | | | |
|--|--|---|
| <p> • Special instruction - take care</p> <p>• Instruction spéciale - faites attention</p> <p>• Instrucciones especiales - presta atención</p> <p>• Besondere Anweisung - bitte beachten</p> <p>• Istruzioni speciali: prestare attenzione</p> <p>• Особая инструкция - Будьте осторожны</p> <p>• 特記事項 - 要注意</p> <p>• 特别说明 - 小心</p> | <p> • Variant assembly</p> <p>• Variante d'assemblage</p> <p>• Variante de montaje</p> <p>• Bauvariante</p> <p>• Assemblaggio alternativo</p> <p>• Варианты сборки</p> <p>• 組み立てバリエーション</p> <p>• 多种组装方式</p> | <p> • Choice of parts</p> <p>• Choix d'éléments</p> <p>• Modelos de componentes</p> <p>• Auswahl an Teilen</p> <p>• Scelta di componenti</p> <p>• Выбор деталей</p> <p>• パーツの選択</p> <p>• 选择部件</p> |
| <p> • Paint before assembly</p> <p>• Peindre avant assemblage</p> <p>• Pintar antes del montaje</p> <p>• Erst bemalen, dann zusammenbauen</p> <p>• Dipingi prima dell'assemblaggio</p> <p>• Покрасьте перед сборкой</p> <p>• 組み立て前にペイントすること</p> <p>• 组装前涂装</p> | <p> • Assembly sequence</p> <p>• Séquence d'Assemblage</p> <p>• Secuencia de montaje</p> <p> • Baureihenfolge</p> <p>• Sequenza di assemblaggio</p> <p>• Последовательность сборки</p> <p>• 組み立て手順</p> <p>• 拼装顺序</p> | <p> • Stage complete</p> <p>• Etape terminée</p> <p>• Paso completado</p> <p>• Schritt abgeschlossen</p> <p>• Fase completa</p> <p>• Этап завершён</p> <p>• このステージの完成</p> <p>• 完成</p> |

CHOOSE THE UNIT YOU WANT TO BUILD | CHOISISSEZ L'UNITÉ À ASSEMBLER

ESCOGE LA UNIDAD QUE QUIERES MONTAR | WÄHLE DIE EINHEIT, DIE DU BAUEN MÖCHTEST

SCEGLI L'UNITÀ CHE VUOI ASSEMBLARE | ВЫБЕРИТЕ ОТРЯД ДЛЯ СБОРКИ

組み立てたいユニットを選択 | 选择您想拼装的单位



 SCOUT SENTINEL

SENTINEL DE RECONNAISSANCE | SENTINEL EXPLORADOR
 WÄCHTER-SPÄHLÄUFER | SENTINEL ESPLORATORE
 РАЗВЕДЫВАТЕЛЬНЫЙ «ЧАСОВОЙ» | スカウト・センチネル
 侦查哨兵



 ARMoured SENTINEL

SENTINEL BLINDÉ | SENTINEL ACORAZADO
 WÄCHTER-STURMLÄUFER | SENTINEL CORAZZATO
 БРОНИРОВАННЫЙ «ЧАСОВОЙ» | タイラントガード
 暴君护卫



! 1-3

• Choose the variant you want to build

• Choisissez la variante à assembler

• Elige qué versión quieres montar

• Wähle die Variante, die du bauen möchtest

• Scegli la variante che vuoi assemblare

• Выберите тот вариант, который хотите собрать

• 組み立てバリエーションの選択

• 选择你喜欢的拼装方式

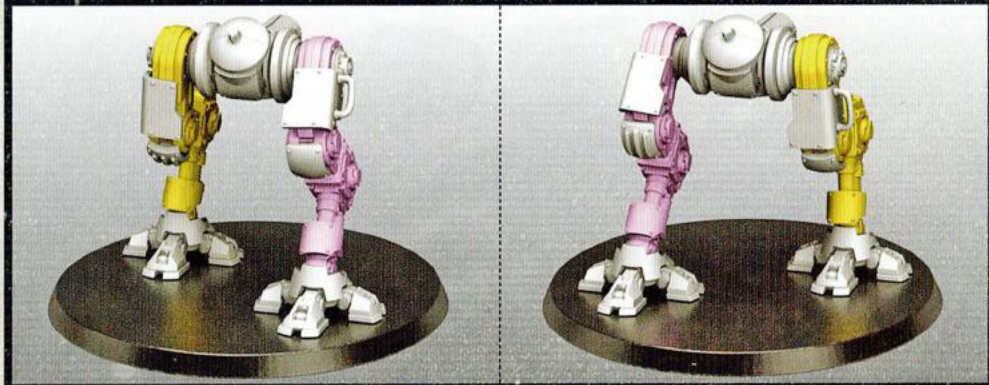

1

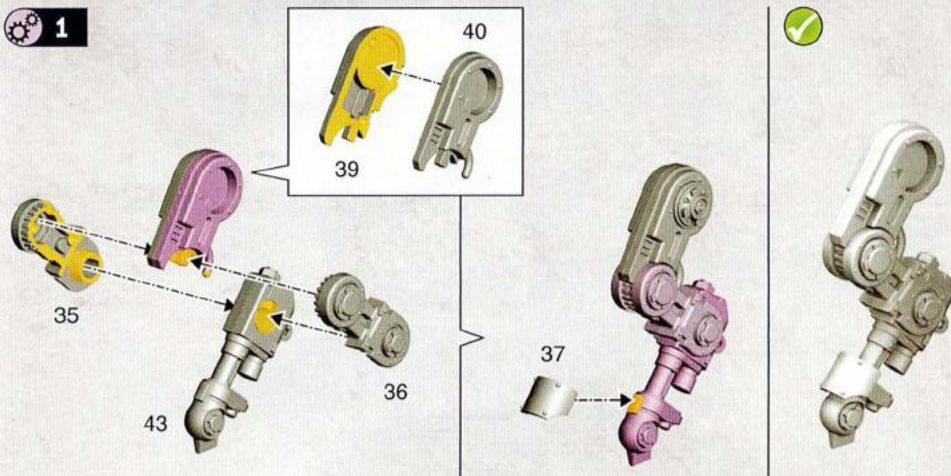

2

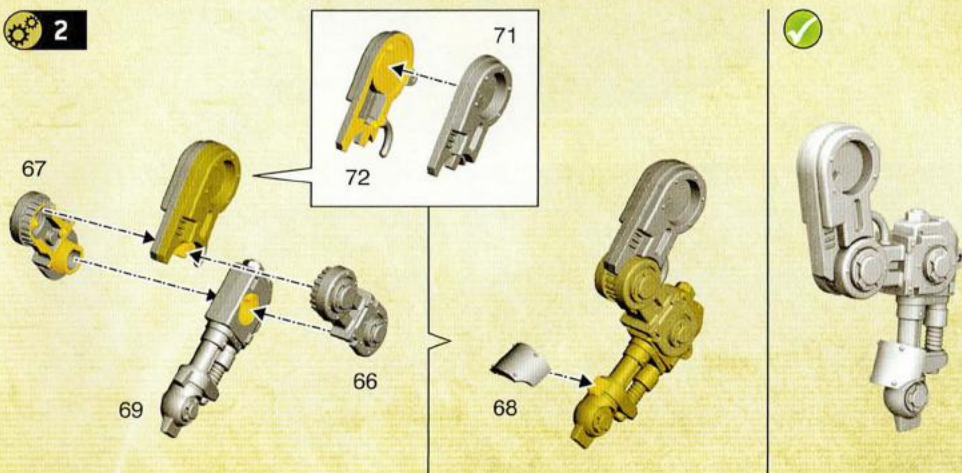

3 a

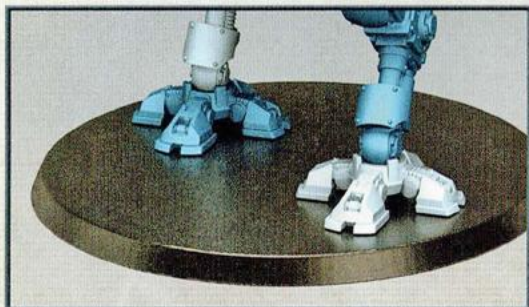
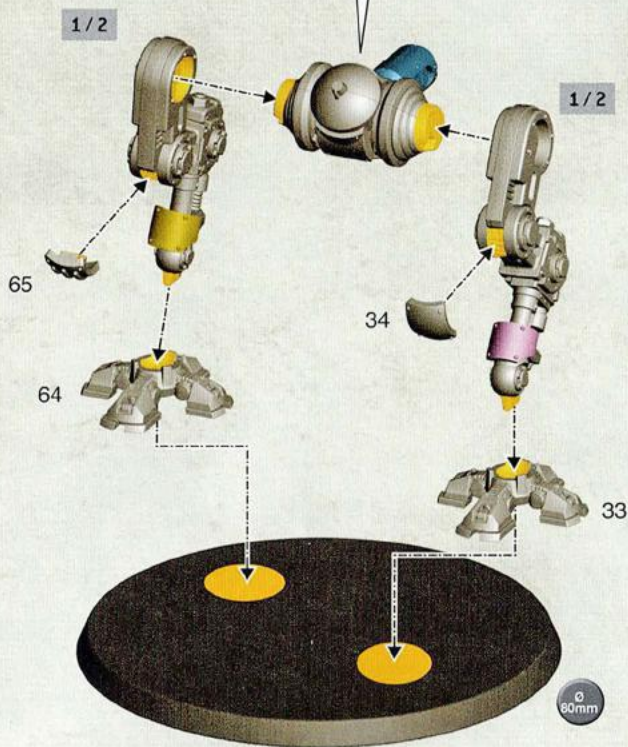
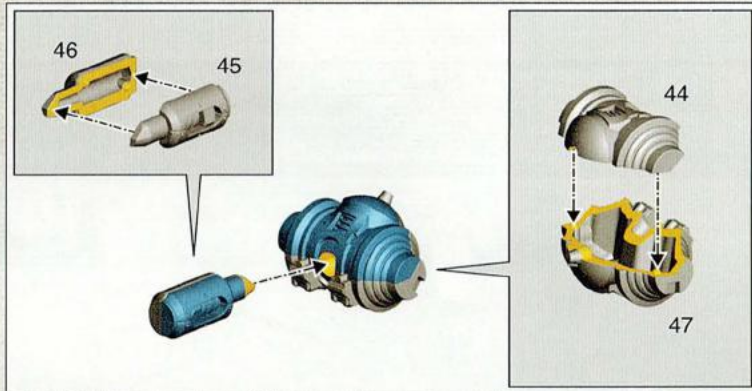

3 b

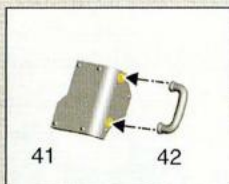

3 c

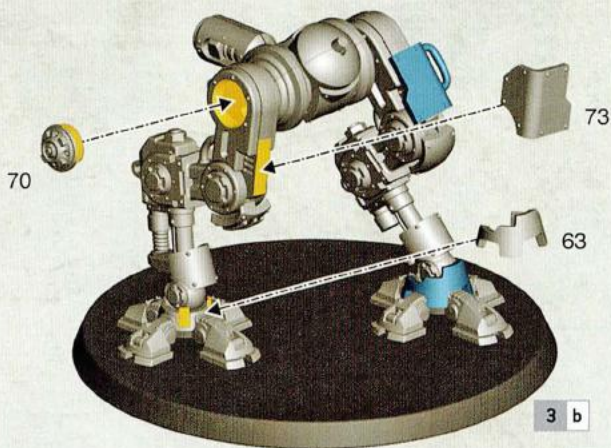

4 a

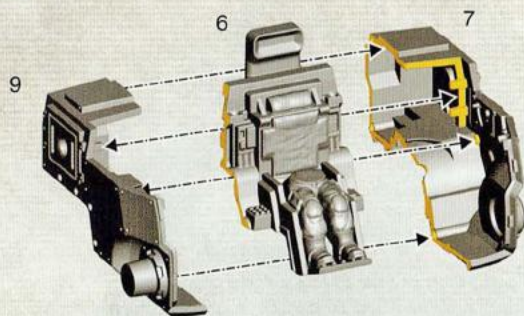

4 b

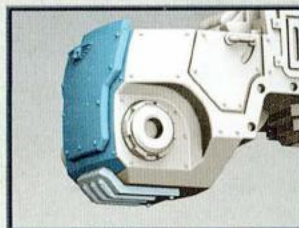
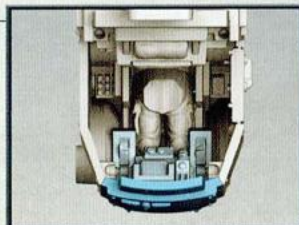
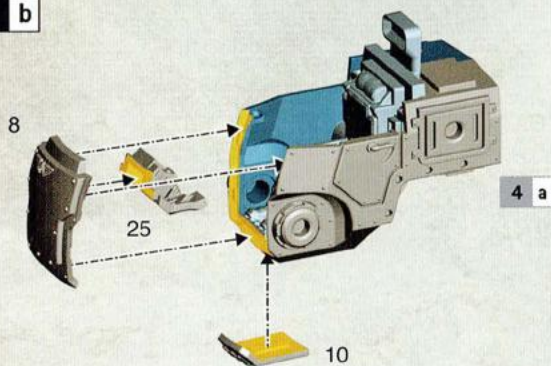

4 c

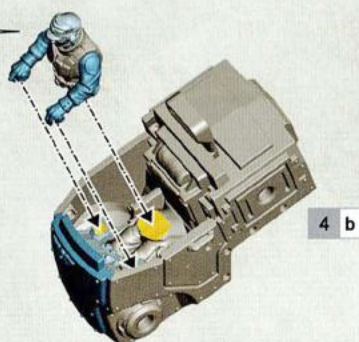
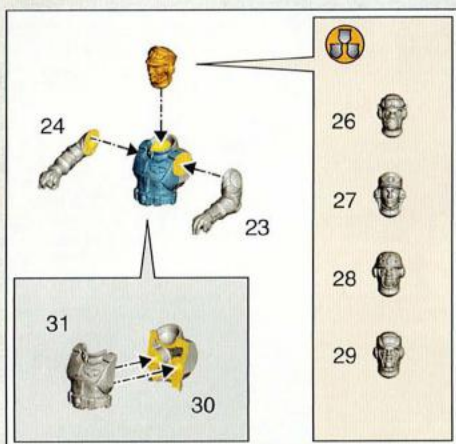

4 d

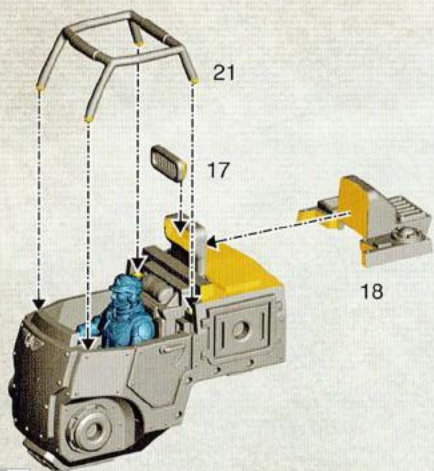

4 c

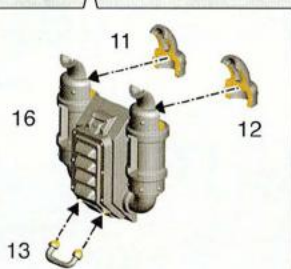

4 e

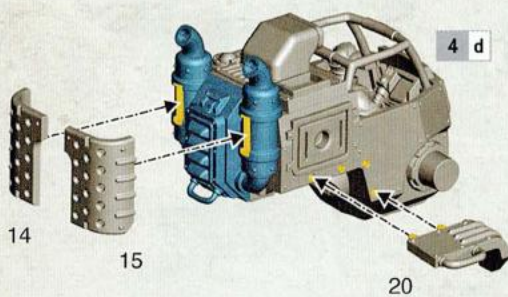

4 d

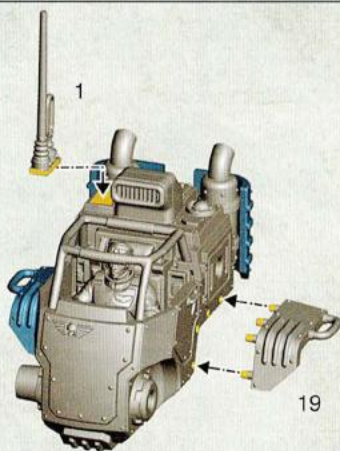

5 a

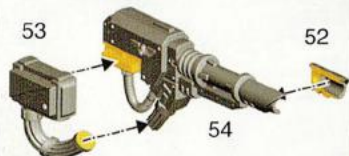

5 b

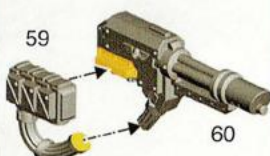

5 c

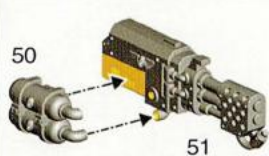
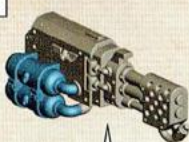

5 d

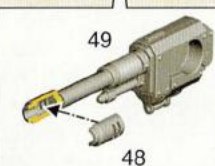

5 e

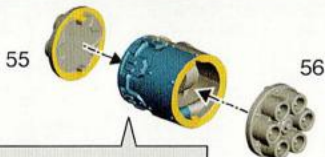

5 f

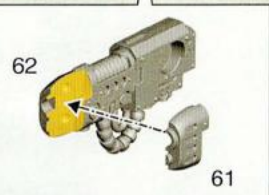

6 a

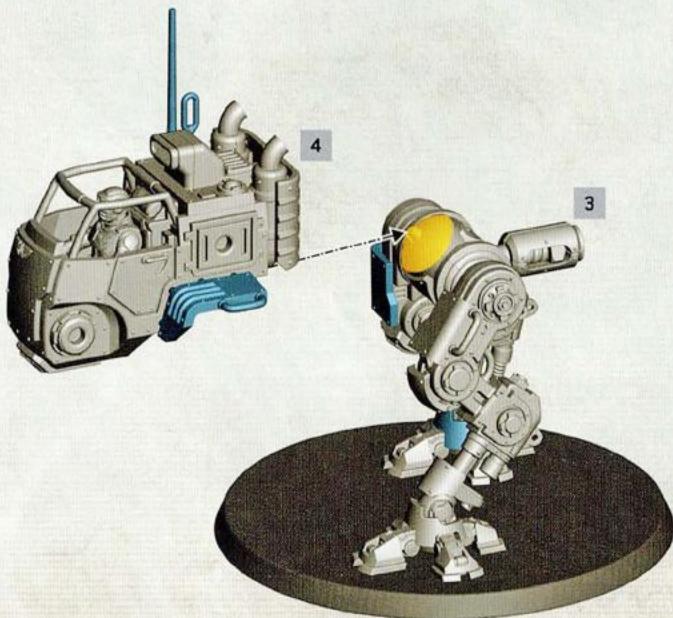

6 b



6 a



6 c

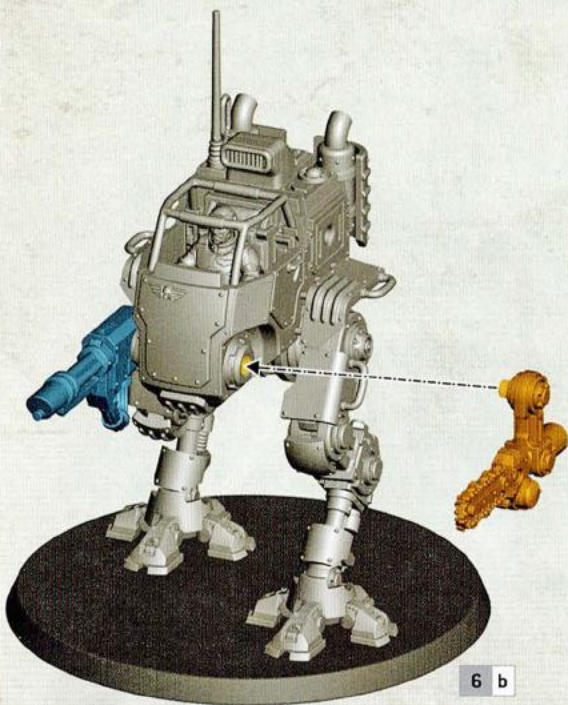

6 b

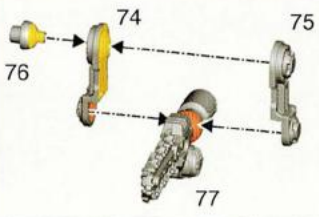
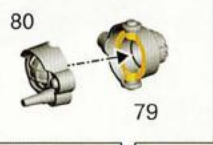

6 d

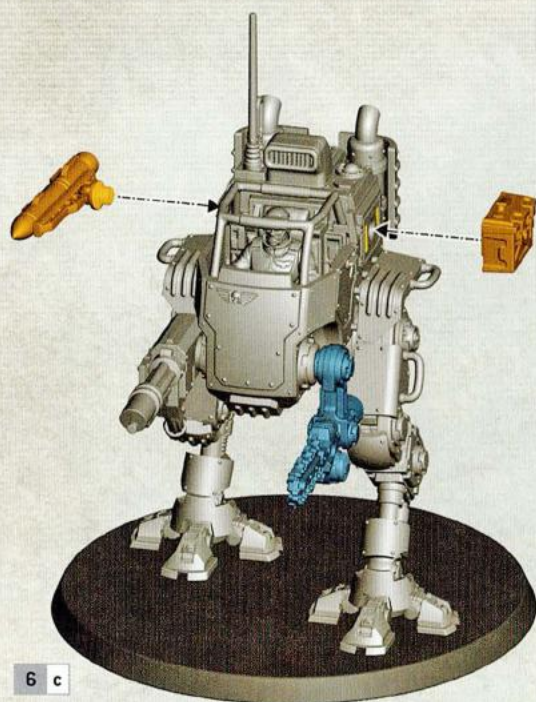

6 c



78

89



82



83

87



88



84



85



86

86

7 a

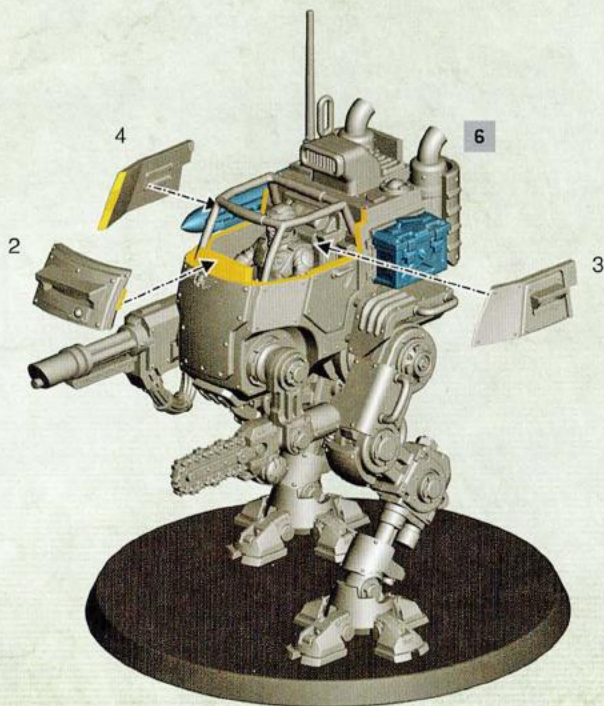

7 b

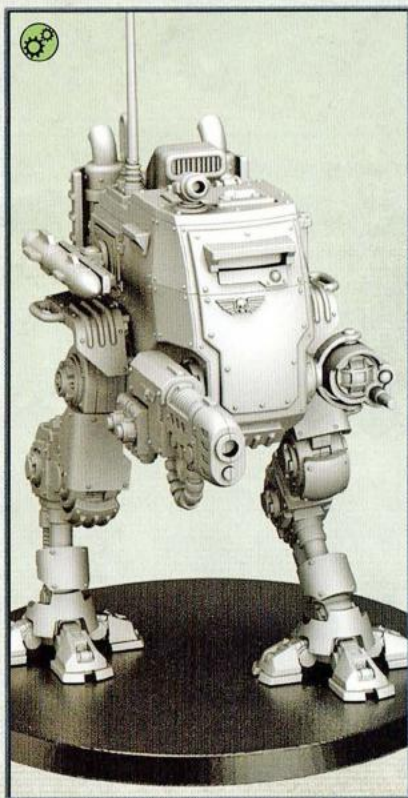
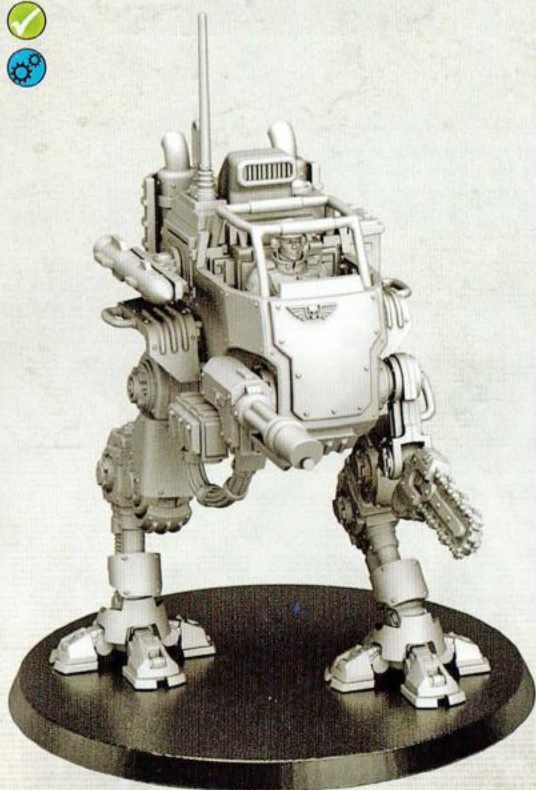
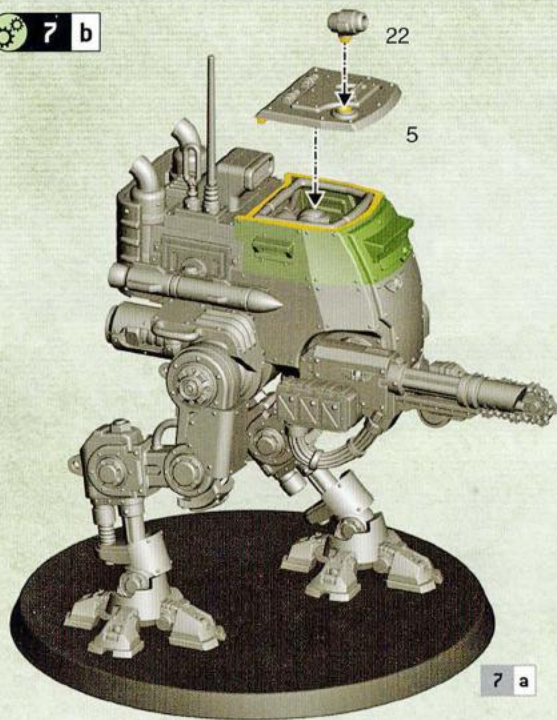

ENG Used alongside the core rules found on warhammer40000.com, the following essential rules will get your new unit on the battlefield. For the full rules for this unit, see the Codex relevant to your army.

FRE Utilisées avec les règles de base disponibles sur warhammer40000.com, les règles essentielles qui suivent vous permettront de jouer votre nouvelle unité. Pour connaître les règles complètes de cette unité, consultez le Codex correspondant à votre armée.

SPA Usadas junto con las reglas básicas que encontrarás en warhammer40000.com, las siguientes reglas esenciales te permiten desplegar esta nueva unidad en el campo de batalla. Para ver las reglas completas de esta unidad, consulta el Codex correspondiente a tu ejército.

GER Mit den Grundregeln auf warhammer40000.com und den folgenden grundlegenden Regeln kannst du deine neue Einheit direkt auf das Schlachtfeld führen. Die vollständigen Regeln für diese Einheit findest du im Codex deiner Armee.

ITA Con le seguenti regole fondamentali, usate assieme alle regole base che puoi trovare su warhammer40000.com, potrai schierare in campo la tua nuova unità. Per le regole complete di questa unità vedi il codex della tua armata.







RUS Следующие необходимые правила, используемые в сочетании с указанными на warhammer40000.com основными правилами, позволят вам задействовать новый отряд на игровом поле. Полные правила для этого отряда указаны в кодексе вашей армии.

日本語 warhammer40000.comに掲載されているコアルールと一緒に使用することで、以下の簡易版ルールでこのユニットを戦場で使用することができます。このユニットの完全版ルールについては、アーミーに対応したコデックスを参照してください。

中文 与 warhammer40000.com 上的核心规则一起使用，以下基本规则适用于您在战场上的新单位。有关该单位的完整规则，请参阅与您军队相关的典典。





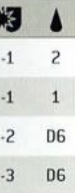
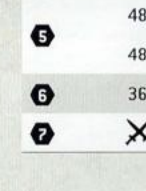
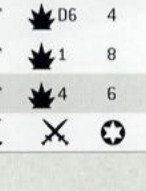
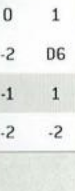

SCOUT SENTINEL

SENTINEL DE RECONNAISSANCE | SENTINEL EXPLORADOR | WÄCHTER-SPÄHLÄUFER | SENTINEL ESPLORATORE
РАЗВЕДЫВАТЕЛЬНЫЙ «ЧАСОВОЙ» | скаут-сенчнел | 偵查哨兵

Scout Sentinel	12"	4+	4+	6	6	7	2	7	4+
									
1	2	3	4	5	6	7	8	9	10
48"	12"	48"	48"	48"	48"	48"	48"	48"	36"
2	D6	1	1	D6	1	1	4	4	X
7	5	10	9	4	8	8	6	6	X
-1	-1	-2	-3	0	-2	-2	-1	-1	X
2	1	D6	D6	1	1	1	1	1	-2

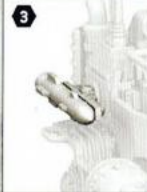
ARMoured SENTINEL

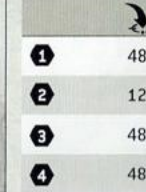
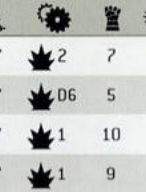
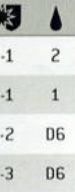
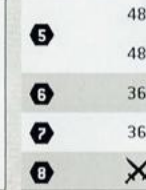
SENTINEL BLINDÉ | SENTINEL ACORAZADO | WÄCHTER-STURMLÄUFER | SENTINEL CORAZATO
БРНИРОВАННЫЙ «ЧАСОВОЙ» | Тайрант-гврд | 暴君护卫

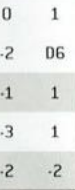
Armoured Sentinel	8"	4+	4+	6	6	7	2	7	3+
									
1	2	3	4	5	6	7	8	9	10
48"	12"	48"	48"	48"	48"	48"	48"	48"	36"
2	D6	1	1	D6	1	1	4	4	X
7	5	10	9	4	8	8	6	6	X
-1	-1	-2	-3	0	-2	-2	-1	-1	X
2	1	D6	D6	1	1	1	1	1	-2



WARHAMMER.COM

Games Workshop Limited, Willow Road, Nottingham, NG7 2WS, UK

© Copyright Games Workshop Limited 2023.

