



Free Downloads of Build Instructions,
Assembly Booklets & How To Guides

BuildInstructions.com

WARHAMMER
40,000

PROPHECY OF THE WOLF



- Assembly instructions • Instructions d'assemblage • Instrucción de montaje • Bauanleitung
- Istruzioni per l'assemblaggio • 拼装指导 • 組み立てガイド



• For illustrative purposes only • Image non contractuelle • Fines meramente ilustrativos • Dient lediglich zur Veranschaulichung
 • Solo a scopo illustrativo • 仅供说明之用 • 裝飾用パーツ

- STEPS • ÉTAPES
- PASOS • SCHRITTE
- FASI • 步骤 • ステップ

1

RAGNAR BLACKMANE



- STEPS • ÉTAPES
- PASOS • SCHRITTE
- FASI • 步骤 • ステップ

2 - 15

PRIMARIS INFILTRATOR SQUAD



x2

1:1

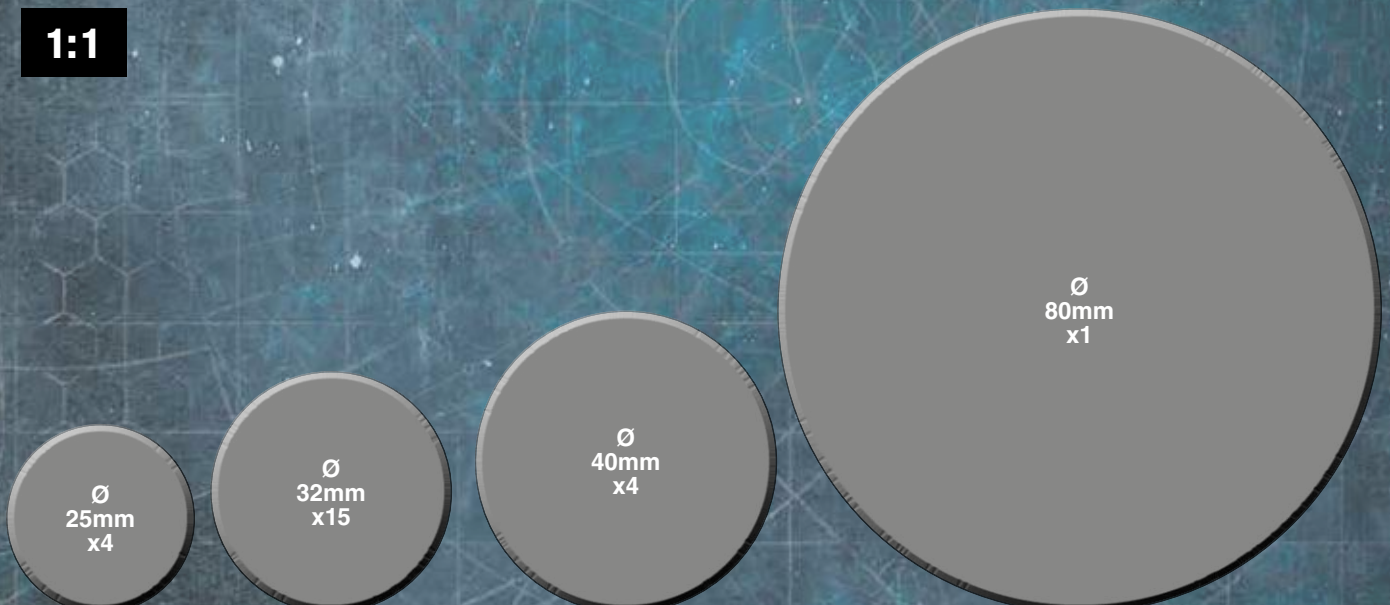

- STEPS • ÉTAPES
- PASOS • SCHRITTE
- FASI • 歩 驟 • ステ ッ プ

16 - 19

GHAZGHKULL THRAKA



- STEPS • ÉTAPES
- PASOS • SCHRITTE
- FASI • 歩 驟 • ステ ッ プ

20 - 24

ORK NOBZ

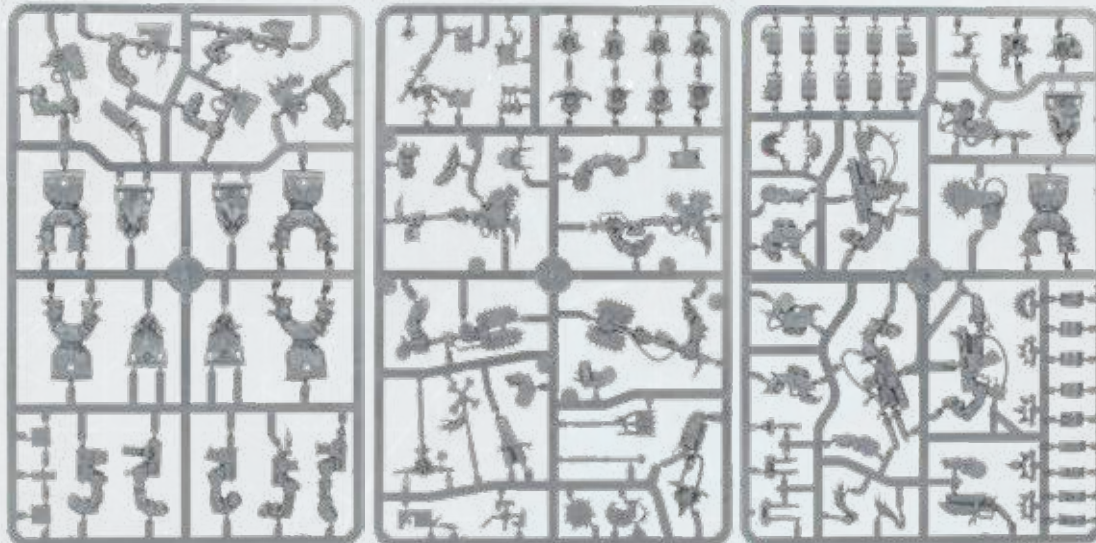

- STEPS • ÉTAPES
- PASOS • SCHRITTE
- FASI • 歩 驟 • ステ ッ プ

25 - 36

ORK MEGANOZ

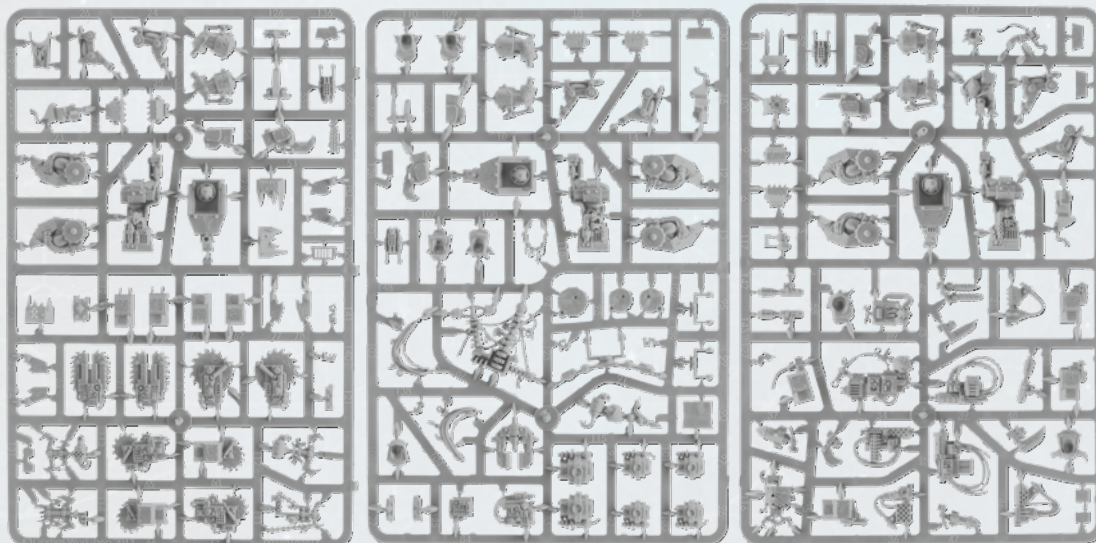



• READ THIS FIRST • À LIRE EN PREMIER • LEER ANTES DE MONTAR • LIES DIES ZUERST
 • LEGGI PRIMA QUESTO • 请优先阅读 • はじめにお読みください。

ENG BEFORE ASSEMBLING YOUR MINIATURES PLEASE READ THROUGH THE INSTRUCTIONS IN THIS BOOKLET CAREFULLY. A pair of plastic cutters is required to remove the plastic components in this kit from their frame. We advise using a mouldline scraping tool to clean up the parts. To assemble your model you will need plastic glue. Games Workshop sells Citadel Fine Detail Cutters, Citadel Mouldline Remover and Citadel Plastic Glue, but does not recommend these products for use by children under the age of 16 without adult supervision.

FRE AVANT D'ASSEMBLER VOS FIGURINES, VEUILLEZ LIRE ATTENTIVEMENT LES INSTRUCTIONS DE CE LIVRET. Une pince coupante est requise pour détacher chaque élément de sa grappe. Nous vous recommandons l'utilisation d'un grattoir pour ébarber les éléments. Pour l'assemblage, vous aurez également besoin de colle plastique. Games Workshop commercialise les Pinces de Précision Citadel, l'Ébarboir Citadel et la Colle Plastique Citadel, mais n'en recommande pas l'utilisation pour des enfants de moins de 16 ans sans la supervision d'un adulte.

SPA POR FAVOR, LEE CUIDADOSAMENTE ESTE LIBRETO DE INSTRUCCIONES ANTES DE EMPEZAR A MONTAR LAS MINIATURAS. Te harán falta unas tenazas para plástico a fin de separar las piezas de la matriz. También aconsejamos una herramienta para rebabas a fin de limpiar cada pieza. Para montar la miniatura necesitarás pegamento para plástico. Games Workshop vende Tenazas Citadel, Herramientas para rebabas Citadel y Pegamento para plástico Citadel, pero no recomienda estos productos a menores de 16 años sin la supervisión de un adulto.

GER VOR DEM ZUSAMMENBAU DER MINIATUREN BITTE DIE ANWEISUNGEN IN DIESER ANLEITUNG AUFMERKSAM DURCHLESEN. Du benötigst einen Kunststoffseitenschneider, um die Kunststoffbauteile aus dem Gussrahmen herauszutrennen, und Kunststoffkleber, um die Miniatur zusammenzubauen. Außerdem empfehlen wir, die Bauteile vorher mit einem Gussgratentferner zu säubern. Games Workshop bietet Präzisions-Kunststoffseitenschneider von Citadel sowie Citadel-Kunststoffkleber an, empfiehlt aber, dass Kinder unter 16 Jahren diese nur unter Aufsicht eines Erwachsenen benutzen.

ITA PRIMA DI ASSEMBLARE LE TUE MINIATURE LEGGI ATTENTAMENTE TUTTE LE ISTRUZIONI DI QUESTO LIBRETTO. Sono necessarie un paio di tronchesine per plastica per staccare i componenti dai loro sprue. Consigliamo di usare un attrezzo apposito per pulire i componenti. Per assemblare il modello avrai bisogno di colla per plastica. Games Workshop vende Tronchesine di precisione Citadel, Attrezzo per ripulire Citadel e Colla per plastica Citadel, ma non consiglia questi prodotti ad un pubblico minore di 16 anni senza la supervisione di un adulto.

CHN 在组装微缩模型之前，请先仔细阅读本手册中的说明。你需要一把模型剪将塑料部件从板件上剪下来。我们建议使用分模线刮刀来处理零件。组装时你还需要用到模型胶水。你可以从 Games Workshop 处购买到 Citadel Fine Detail Cutter 模型剪、Citadel Mouldline Remover 分模线刮刀和 Citadel Plastic Glue 模型胶，但 16 岁以下儿童不得在没有成年人监护的情况下使用这些产品。

JAP ミニチュアを組み立てる前に、必ずこの説明書をよくお読みください。本キット内のフレームからプラスチックパーツを切り離すためには、ニッパーが必要です。パーツのモールドを平らにするには、専用ツールの使用をお勧めいたします。本キットの組み立てには、プラ用接着剤が必要です。ゲームワークショップはシタデル・ニッパー、プラ用接着剤、シタデル・モールドラインリムーバーを販売しておりますが、16歳以下の子供が大人の監督なしにこれらの道具を使用されることをお勧めしません。

• EXPLANATION OF SYMBOLS • EXPLICATION DES SYMBOLES • EXPLICACIÓN DE SIMBOLOS
 • ERLÄUTERUNG DER SYMBOLE • LEGENDA DEI SIMBOLI • 符号说明 • アイコン解説



- Special instruction - Please read
- Instructions spéciales - Lire attentivement
- Instrucción especial: Por favor, léela
- Besondere Anweisung - Bitte lesen
- Istruzioni speciali - Leggi attentamente
- 特殊说明—请详阅
- 特記事項 - 必ずお読みください



- Choice of parts
- Choix d'éléments
- Modelos de componentes
- Auswahl an Teilen
- Scelta di componenti
- 选择部件
- パーツの選択



- Repeat process
- Répéter l'étape
- Repetir pasos
- Vorgang wiederholen
- Ripeti il processo
- 重复步骤
- 同じ作業を繰り返すこと



- Dry fit stage before gluing
- Tester avant de coller
- Comprobar el encaje antes de pegar
- Positionierung erst ohne Klebstoff ausprobieren
- Prova a secco prima di incollare
- 粘接前的假组阶段
- 粘接前にぴったり合わせること



- Variant assembly
- Variante d'assemblage
- Variante de montaje
- Bauvariante
- Assemblaggio alternativo
- 多种组装方式
- 組み立てバリエーション



- Stage complete
- Étape terminée
- Paso completado
- Schritt abgeschlossen
- Fase completa
- 完成
- このステージの完成

• GUIDE TO USING THESE INSTRUCTIONS • GUIDE D'UTILISATION DE CES INSTRUCTIONS
 • GUÍA DE USO DE ESTAS INSTRUCCIONES • ERKLÄRUNG DER ANWEISUNGEN
 • GUIDA ALLE ISTRUZIONI • 说明指南 • この説明の見方

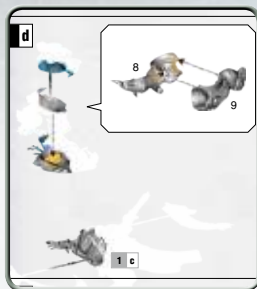

- Blue area - Previously assembled components
- Zone bleue - Éléments déjà assemblés
- Área azul - Partes montadas previamente
- Blau markiert: zuvor zusammengebaute Teile
- Area blu - Componenti precedentemente assemblati
- 蓝色区域 - 预组装零件
- 青色エリア - パーツを事前に組み立てておくこと

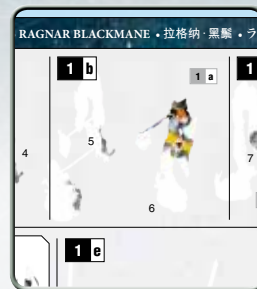

- Yellow area - Glue points
- Zone jaune - Points de colle
- Áreas amarillas - Aplicar pegamento en estos puntos
- Gelb markiert: Klebepunkte
- Area gialla - Punti di incollaggio
- 黄色区域 - 粘接点
- 黄色エリア - 接着すること

1

RAGNAR BLACKMANE

• RAGNAR BLACKMANE • 拉格纳·黑鬃 • ラグナー・ブラックメイン

1 a

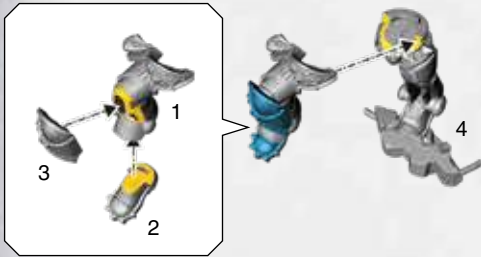

1 b

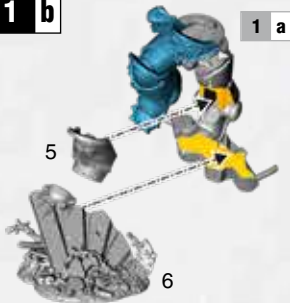

1 c



1 d

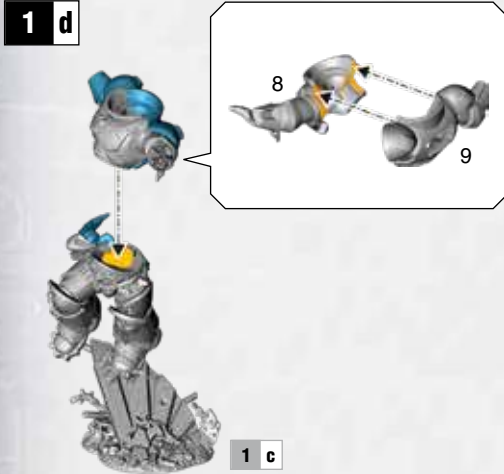

1 e

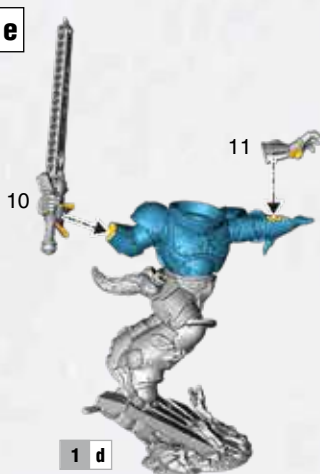

1 f



1 g

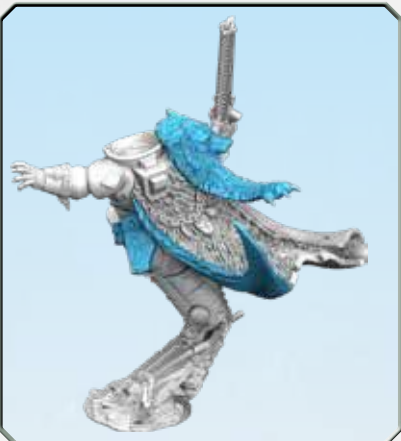
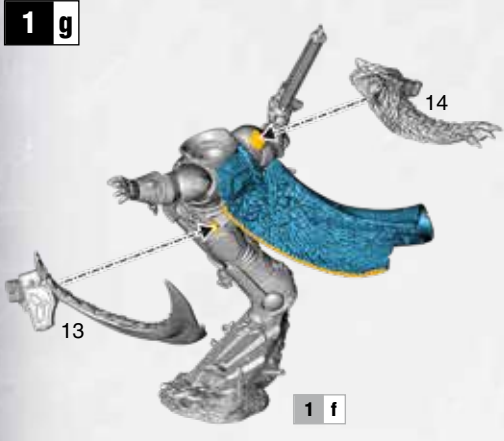

1 h

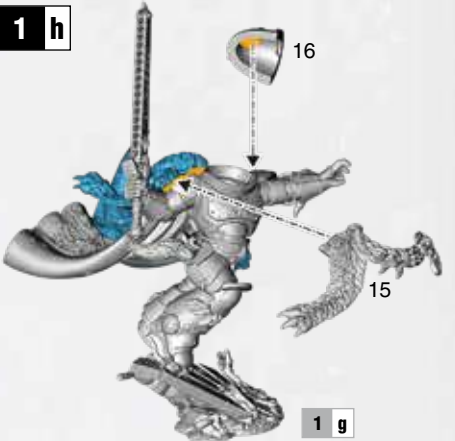

1 i

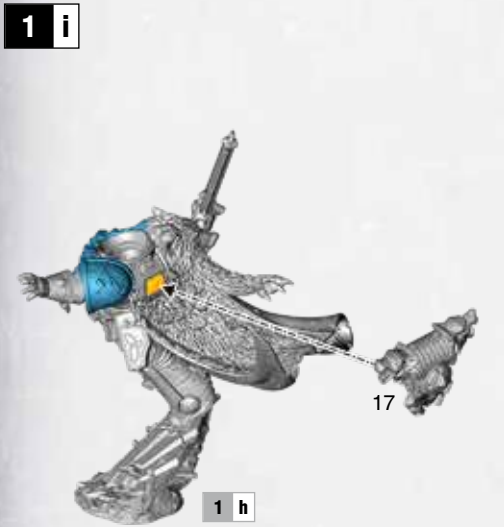

1 j

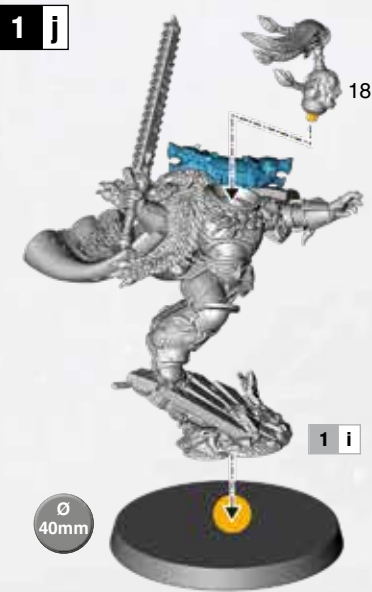

CHOOSE THE VARIANT YOU WANT TO BUILD
CHOISISSEZ LA VARIANTE À ASSEMBLER • ELIGE QUÉ VERSIÓN QUIERES MONTAR
WÄHLE DIE VARIANTE, DIE DU BAUEN MÖCHTEST • SCEGLI LA VARIANTE CHE VUOI ASSEMBLARE
选择你喜欢的拼装方式 • み立てバリエーションの

INFILTRATOR SQUAD

• Infiltrator Squad • 渗透者小队 • インフィルトレーター・スカッド

STEPS • ÉTAPES • PASOS
SCHRITTE • FASI

2 - 10



INCURSOR SQUAD

• Incursor Squad • 入侵者小队 • インカーサー・スカッド

STEPS • ÉTAPES • PASOS
SCHRITTE • FASI

2 - 6

11 - 15

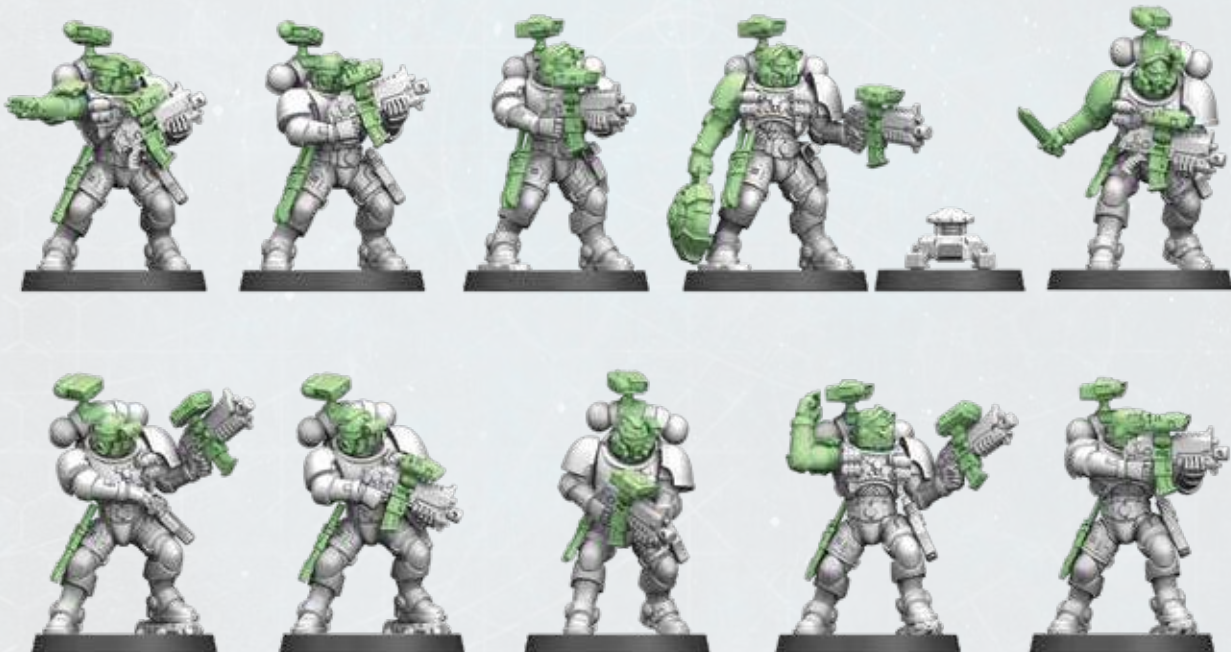



FOLLOW STEPS 2-6 FOR ALL VARIANTS • SUIVRE LES ÉTAPES 2-6 POUR TOUTES LES VARIANTES • SIGUE LOS PASOS 2-6 PARA TODAS LAS VARIANTES
 FOLGE DEN SCHRITTEN 2-6 FÜR ALLE VARIANTEN • SEGUI LE FASI DA 2 A 6 PER TUTTE LE VARIANTI
 所有组装方式请见第 2-6 步 • ステップ2 - 6は全バリエーション共通

2 a x2

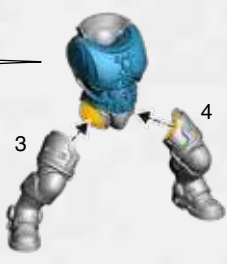
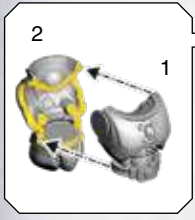

2 b

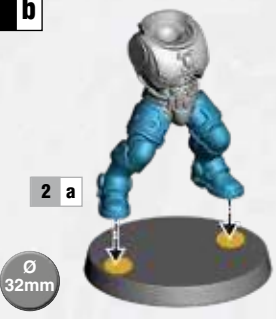

3 a x2



3 b

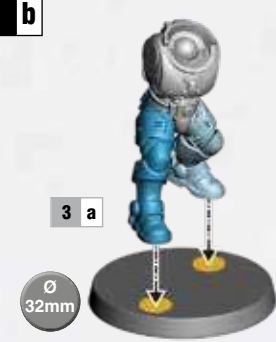

4 a x2

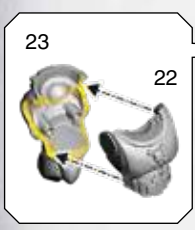

4 b

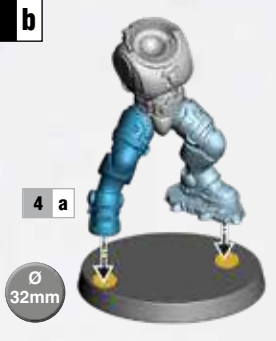

5 a x2

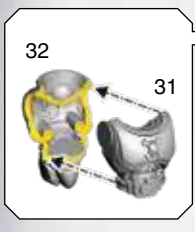

5 b



6 a x2

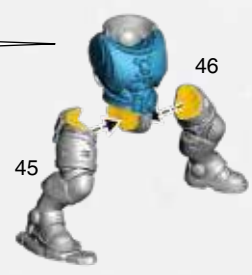
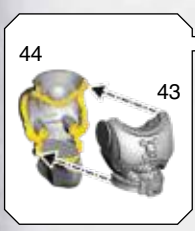

6 b

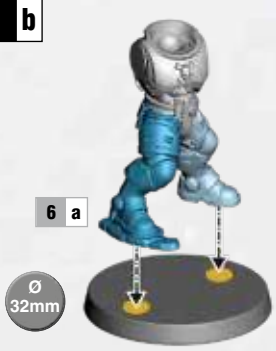

7 a • Infiltrator Sergeant • 滲透者軍士 • インフィルトレイター・サージェント



10 76



11

7 b



53 x10



7 a



7 c

- 82 x6
- 83 x4

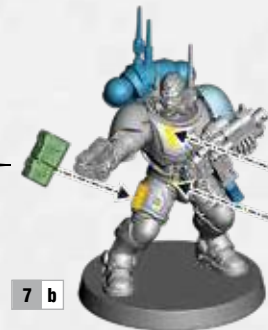

7 b

- 86 x2
- 84 x2 87 x2
- 85 x2 88 x2

- 94 x2 95 x2 96 x2 97 x2 98 x2 99 x2



8 a • Infiltrator Comms Array • 滲透者武器阵列 • インフィルトレイター通信装置



5

8 b

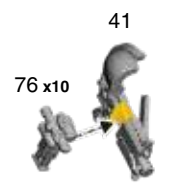

76 x10



8 a

8 c

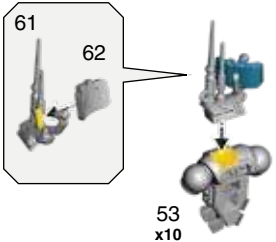

53 x10



8 b



9 a



5

2

6

76 x10

✓



9 b x2



16

3

18

17

76 x10

✓



9 c



26

4

28

27

76 x10

✓



9 d



29

4

30

76 x10

✓



9 e

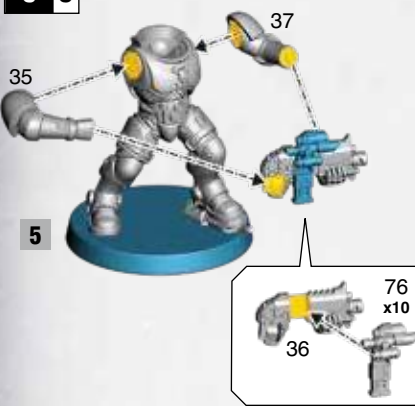

35

5

37

36

76 x10

✓

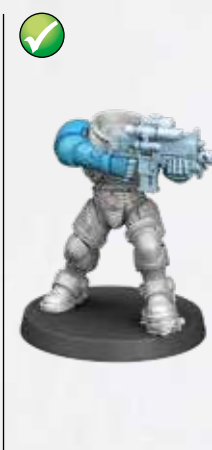

9 f x2

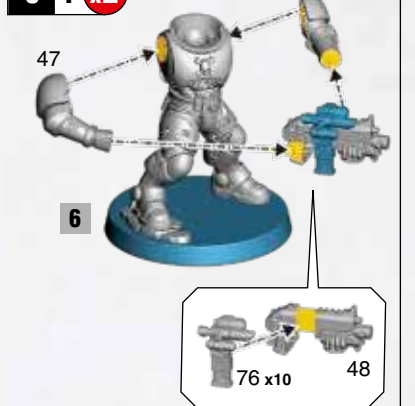

47

6

49

48

76 x10

✓



10 a x8

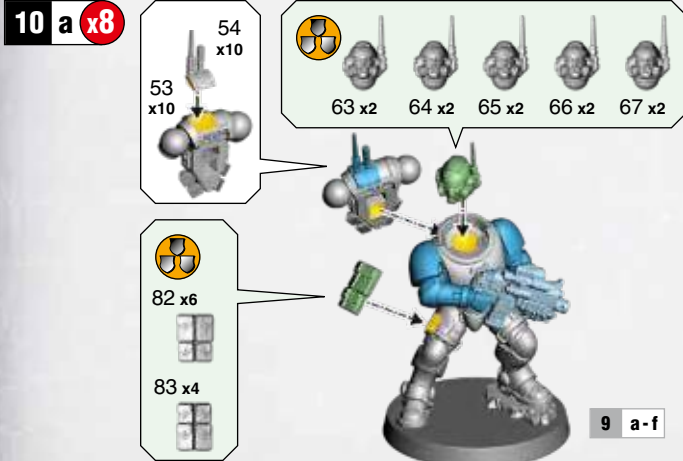

53 x10

54 x10

63 x2

64 x2

65 x2

66 x2

67 x2

82 x6

83 x4

9 a-f

10 b x8

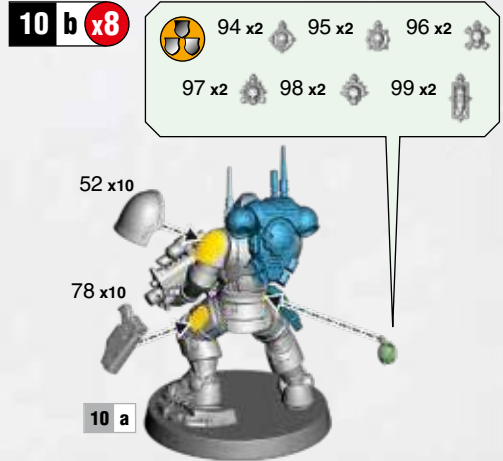

94 x2

95 x2

96 x2

97 x2

98 x2

99 x2

52 x10

78 x10

10 a

10 c x8

84 x2 85 x2
86 x2 87 x2 88 x2

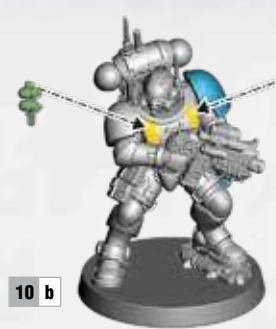

91 x2
89 x2 92 x2
90 x2 93 x2



11 - 15 INCURSORS • Incursors • 入侵者 • インカーサー

11 a • Incursor Sergeant • 入侵者軍士 • インカーサー・サージェント



10 77 x10
11

11 b

58 x2
53 x10



11 c

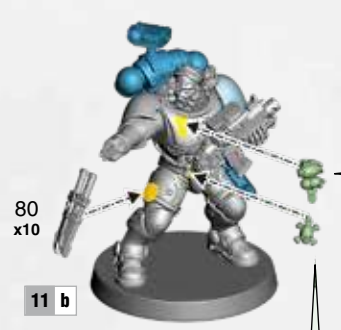

86 x2
84 x2 87 x2
85 x2 88 x2



94 x2 95 x2 96 x2 97 x2 98 x2 99 x2



12 a • Incursor with haywire mine • Incursor avec Mine Disruptrice • Incursor con mina de disruptión • Incursor mit Impulssprengladung
 • Incursor con mina electromagnetica • 装备缠丝地雷的入侵者 • インカーサー (ヘイワイア・メイン装備)

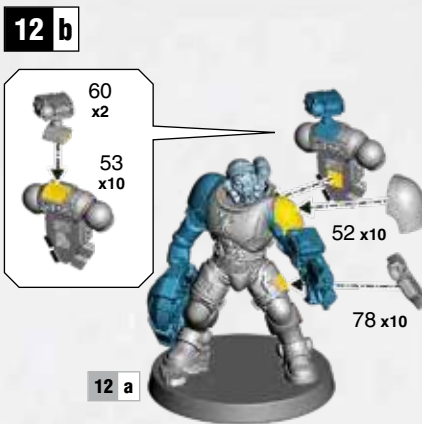
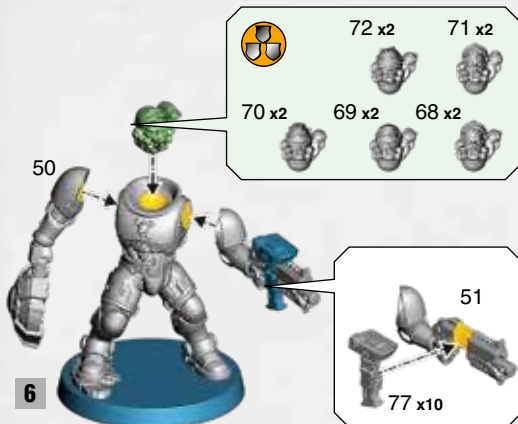

13 a • Haywire Mine
 • 缠丝地雷 • ヘイワイア・メイン

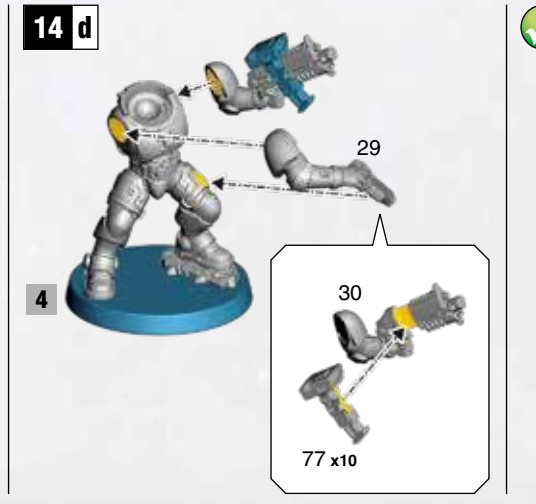
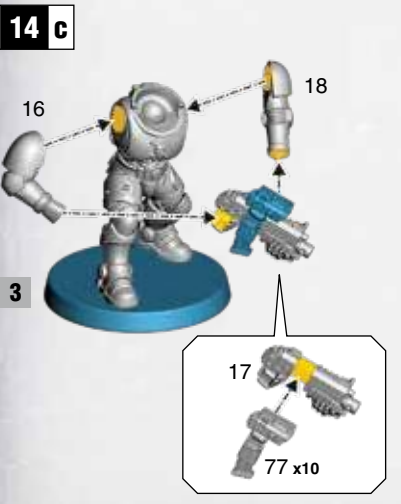
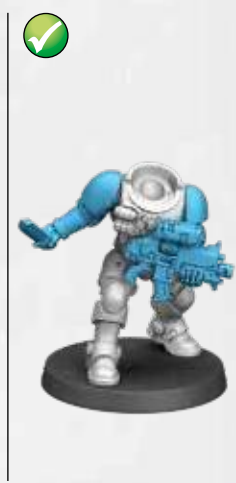
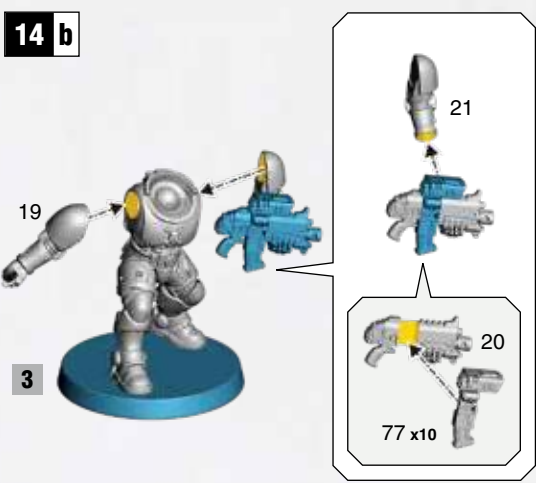
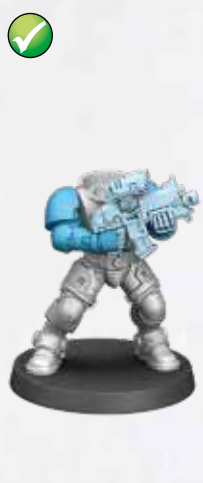
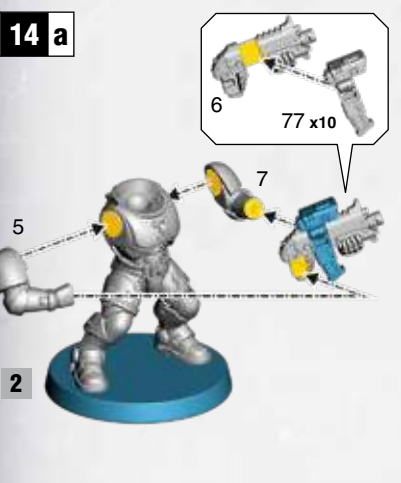
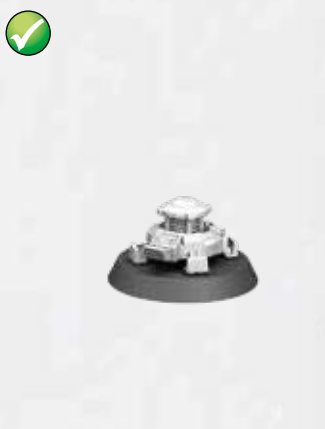
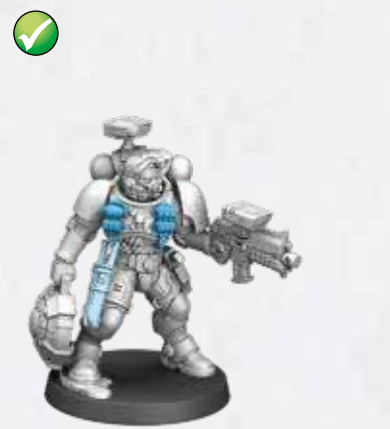
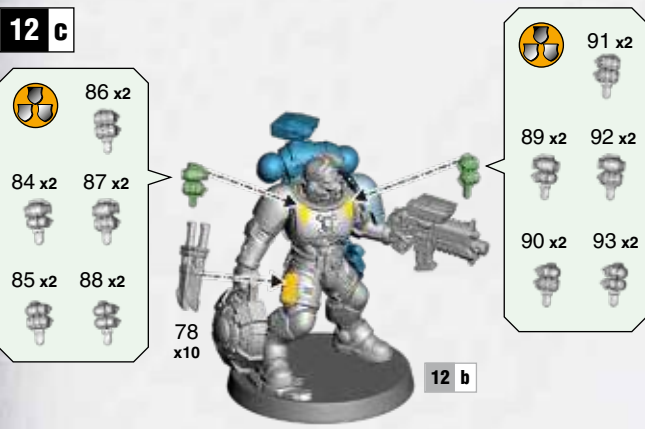
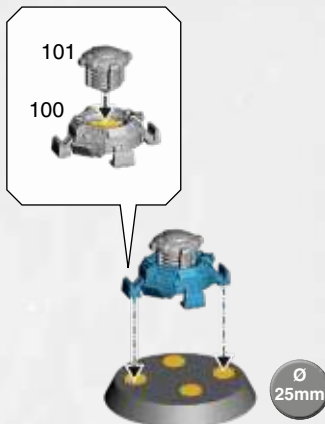

14 e

26

4

27

77 x10

14 f

38

5

39

77 x10

14 g

37

35

5

36

77 x10

14 h

49

47

6

48

77 x10

15 a x8

58 x2

56 x2

59 x2

57 x2

60 x2

53 x10

15 b x8

72 x2

71 x2

70 x2

69 x2

68 x2

81 x2

80 x10

14 a-h

15 c x8

84 x2

85 x2

86 x2

87 x2

88 x2

89 x2

90 x2

91 x2

92 x2

93 x2

15 b

16 a

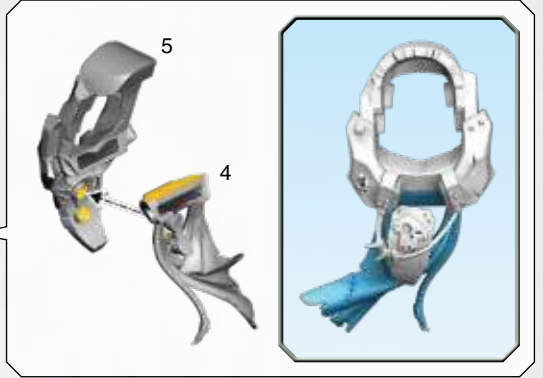
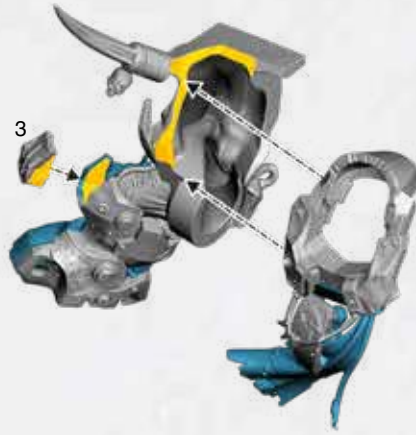
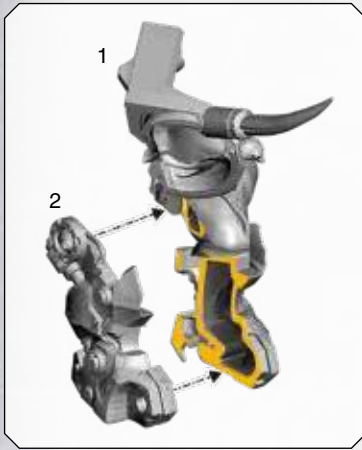

16 b

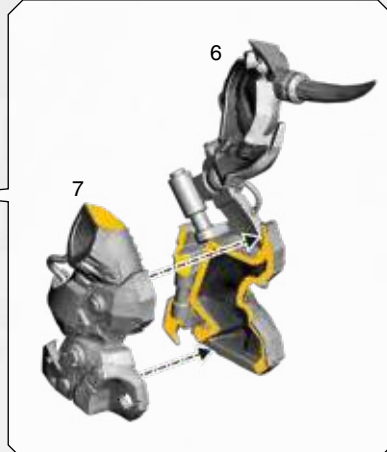
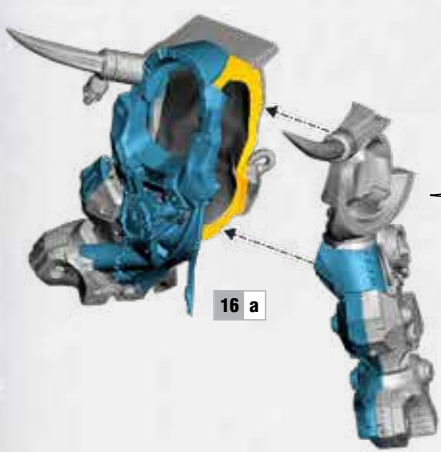

16 c



16 d

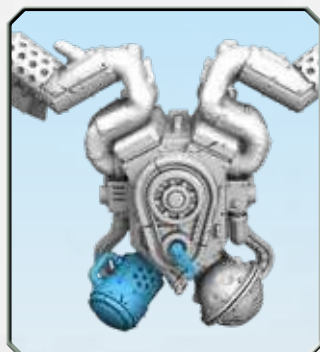
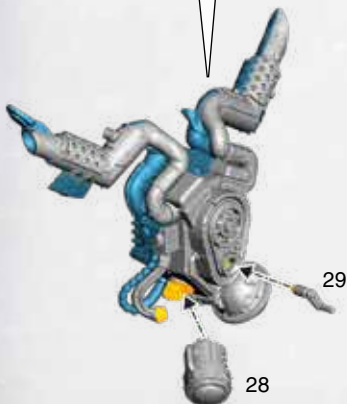
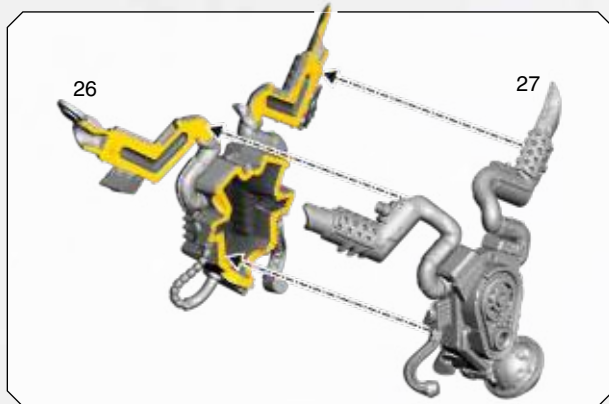

16 e

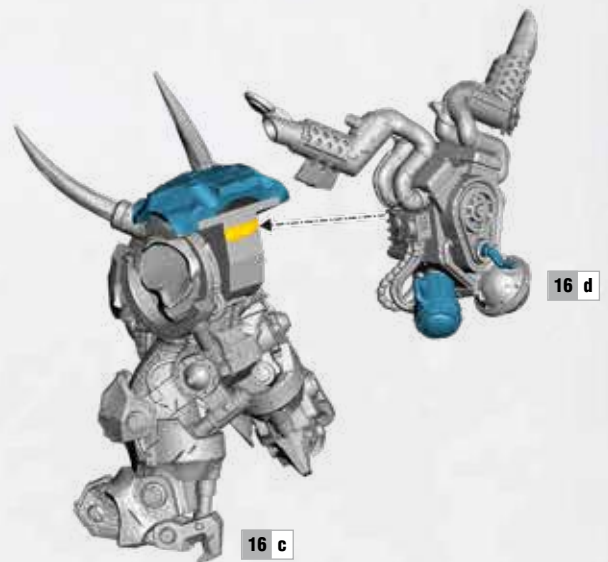

16 f

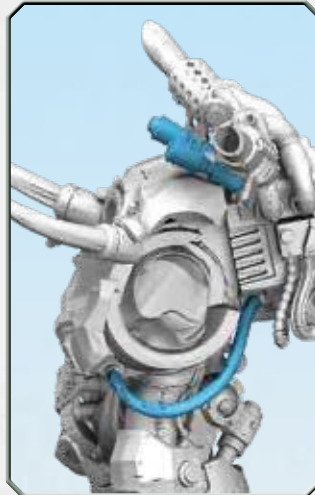
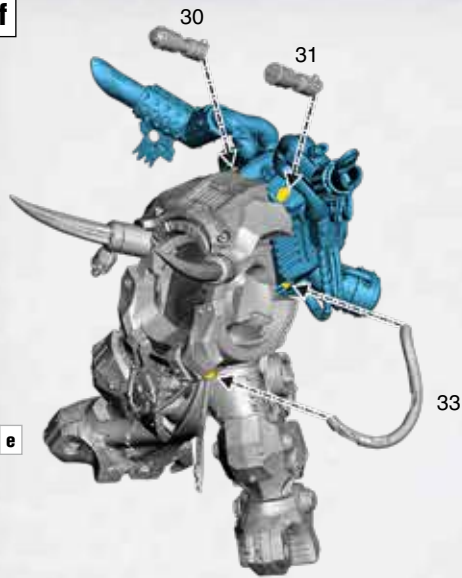

16 e

17 a

• Mork's Roar • Rugissement de Mork • Rugido de Mork • Morks Gebrüll • Ruggito di Mork • 摩克的咆哮 • モルクの怒鳴り

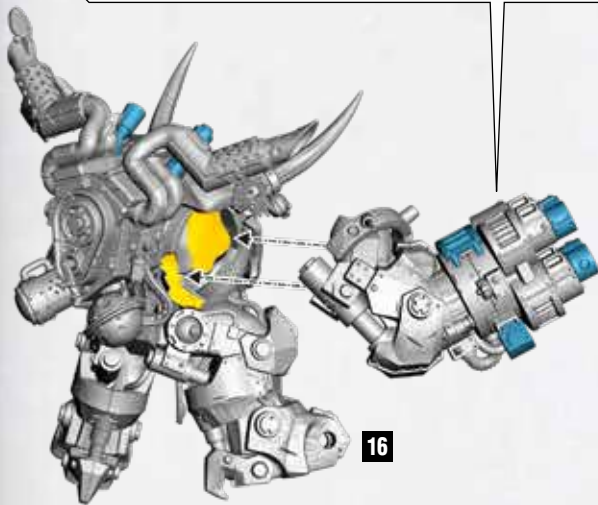
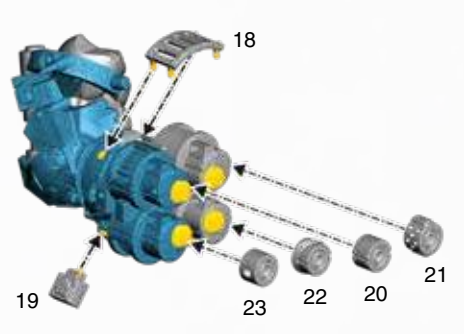
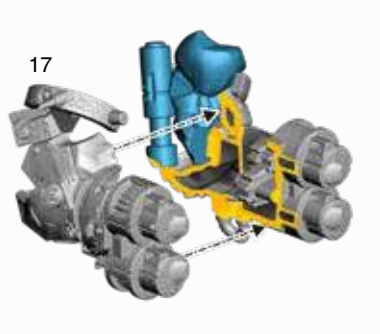
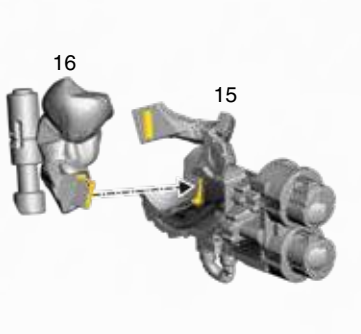

17 b

• Gork's Claw • Griffes de Gork • Garra de Gork • Gorks Krallä
• Kela di Gork • 格克的利爪 • ゴルクのクロオ

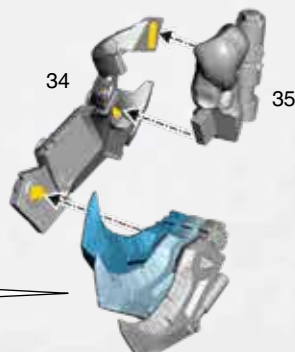
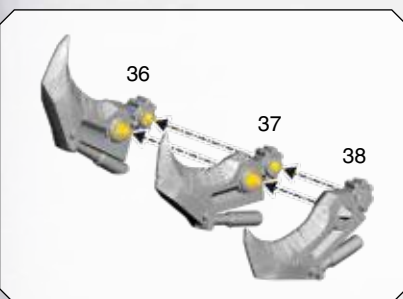

17 c

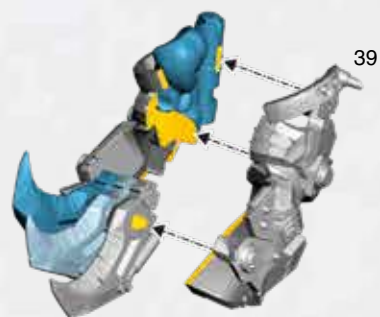

17 d

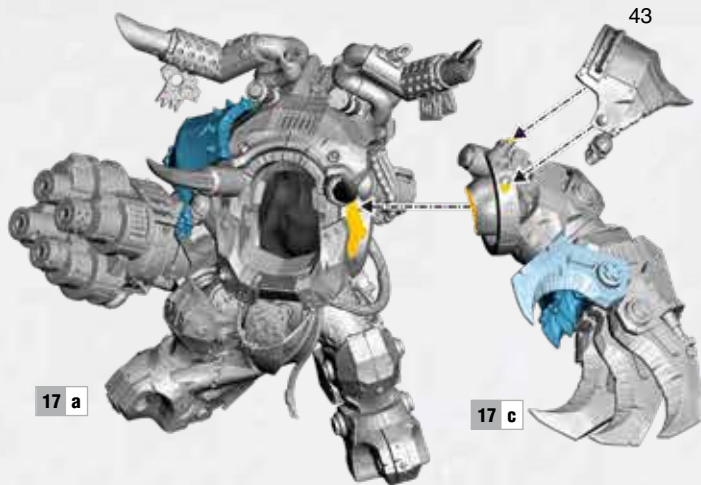

17 e



18 a



• Choose the variant you want to build • Choisissez la variante à assembler • Elige qué versión quieres montar
 • Wähle die Variante, die du bauen möchtest • Scegli la variante che vuoi assemblare • 选择你喜欢的拼装方式 • み立てバリエーションの



18 a 

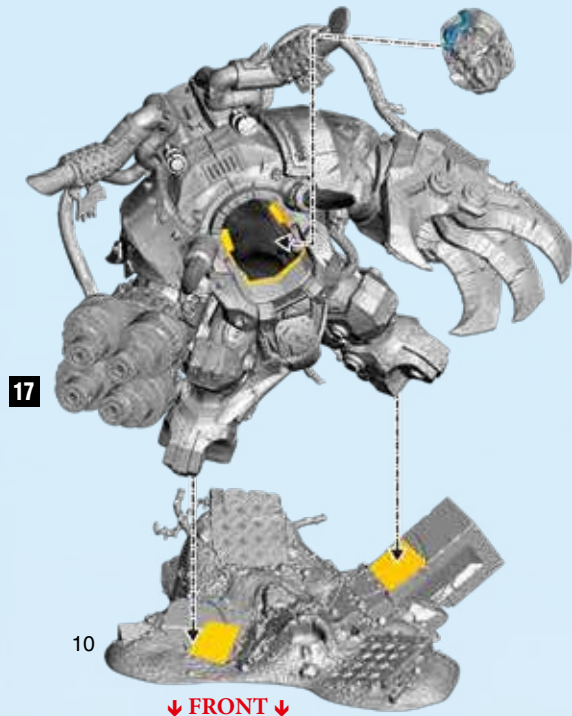

10

↓ FRONT ↓

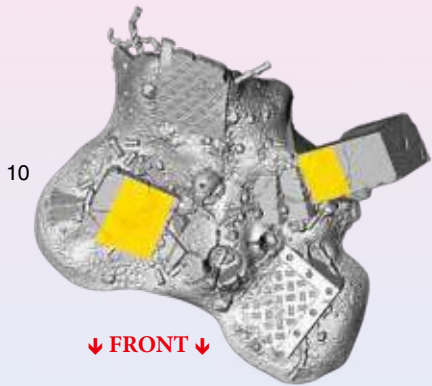

10

↓ FRONT ↓

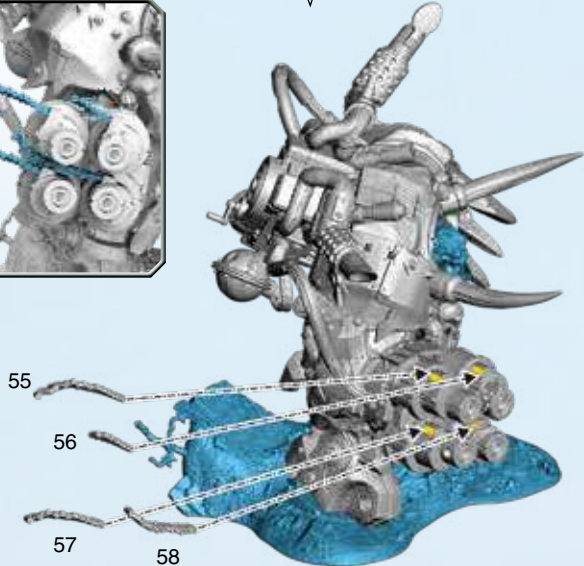
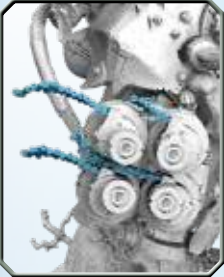

55

56

57

58

18 a 

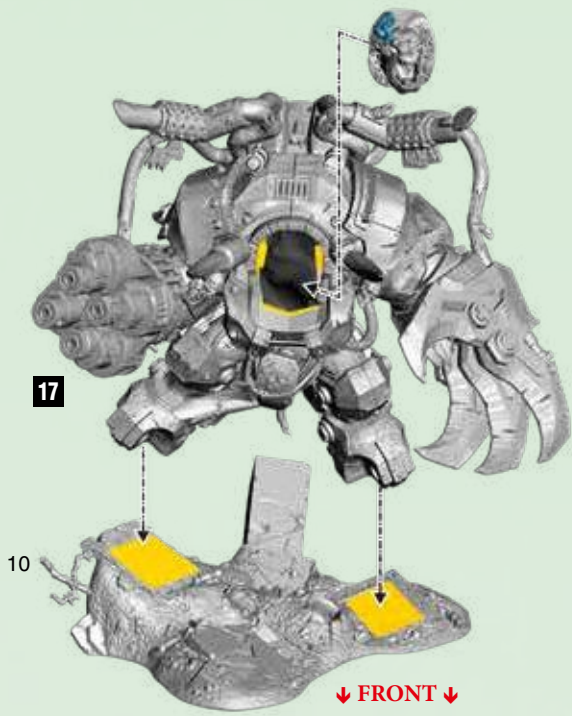

10

↓ FRONT ↓

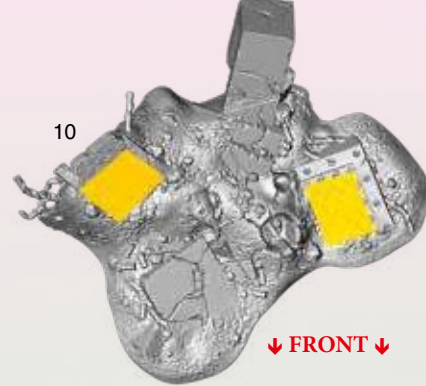

10

↓ FRONT ↓



59

60

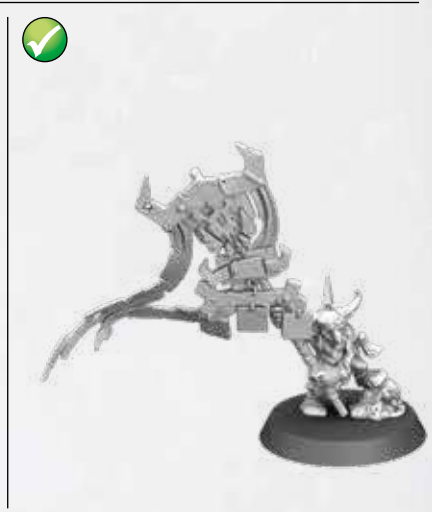
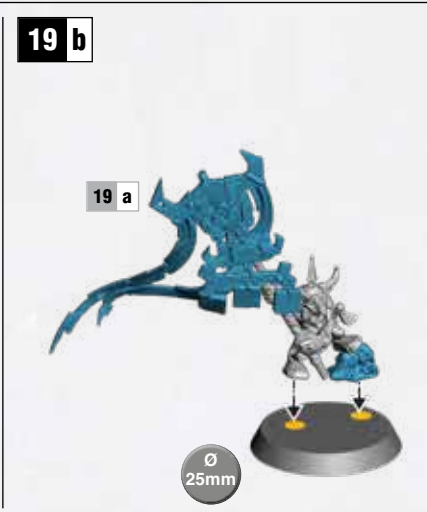

20 - 24 **ORK NOBZ** • Ork Nobz • 欧克强蛮人 • オルク・ノブ

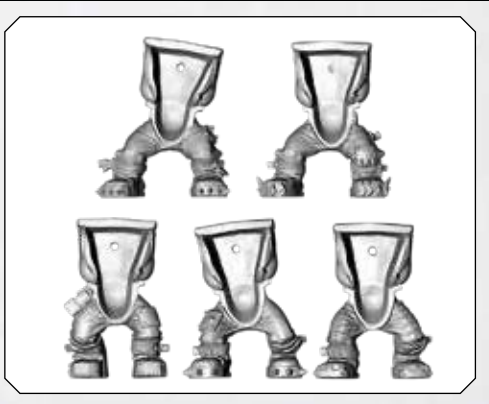

20 b x5



20 a



• INTERCHANGEABLE PARTS • ÉLÉMENTS INTERCHANGEABLES • PARTES INTERCAMBIABLES
 • AUSTAUSCHBARE TEILE • COMPONENTI INTERCAMBIABILI • 可互换的部件 • 交換可能なパーツ

21 a

• Choppas / sluggas • Kikoup' / kalibr' • Rebanadora / piztola • Spalta / Knarre
 • Zpakka / ferri • 砍刀/短銃 • チョップバ/スラッグ

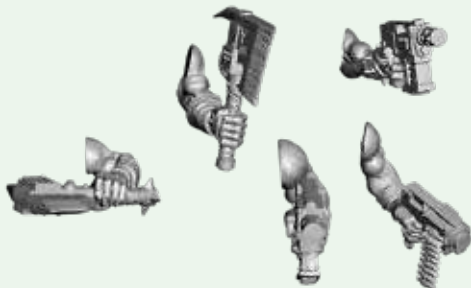

• Power stabba / killsaw • Marteau-pilon énergétique / Diskeuz'
 • Mekapincho / Motozierra • Energiestecha / Killasäga
 • Koltello potenziato / Zega azzazzina
 • 能量匕首/茶戮锯 • パワースタッパ/ブチ殺りノコギリ



• Power klaw • Pines kitu
 • Garraz de kombate • Energiekrallä
 • Kela potenziata
 • 能量爪 • パワークロオ

21 b

x3

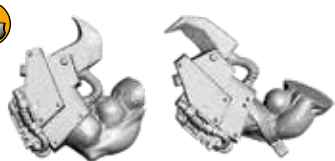
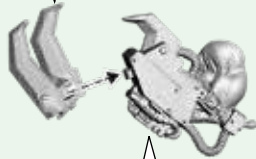

• Kombi-weapon with skorcha / kombi-weapon with rokkit launcha
 • Arme kombinée avec karbonizator / Arme kombinée avec lance-rokettes
 • Kombi-arma con kemakema / Kombi-arma con lanzako hetez
 • Kombiwumme mit Gitbrenna / Kombiwumme mit Bazzukka
 • Kombiarma con zkotta / Kombiarma con zparamizzili
 • 带有喷火器的双联武器 / 带有火箭发射器的双联武器
 • コンビスコーチャ/コンビロケット

21 c

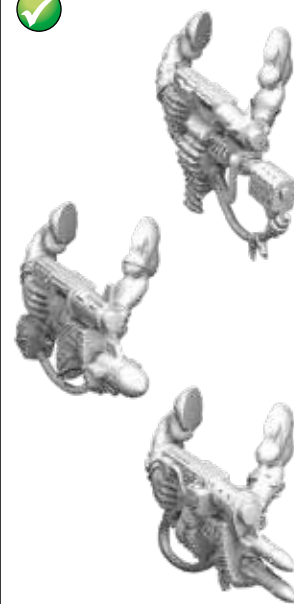
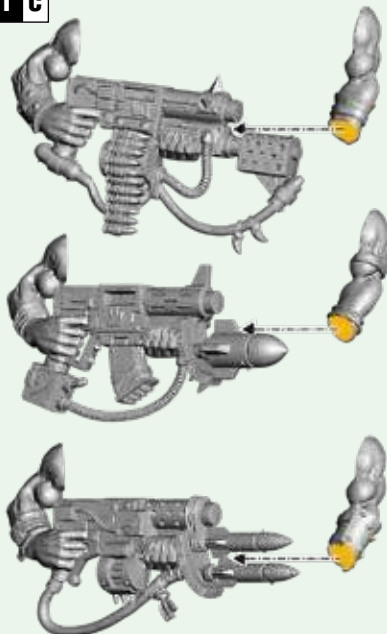



• USE MATCHING PARTS • UTILISER LES ÉLÉMENTS CORRESPONDANTS • USA LAS PIEZAS QUE CORRESPONDAN
 • VERWENDE DIE PASSENDEN TEILE • USA LE PARTI CORRISPONENTI • 使用匹配部件 • 適合するパーツを使用

21 d

• Big choppa • Gros kikoup' • Gran rebanadora • Fetter Spalta • Zpakka Grozzo • 大砍刀 • ビッグチョッパ

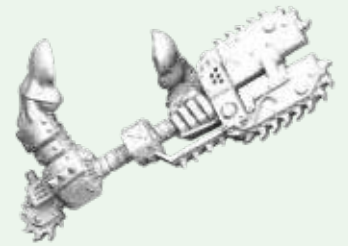
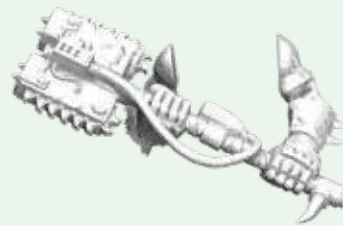
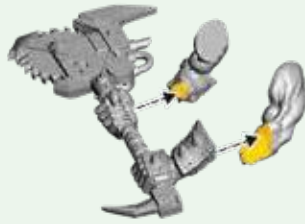

22 a x5

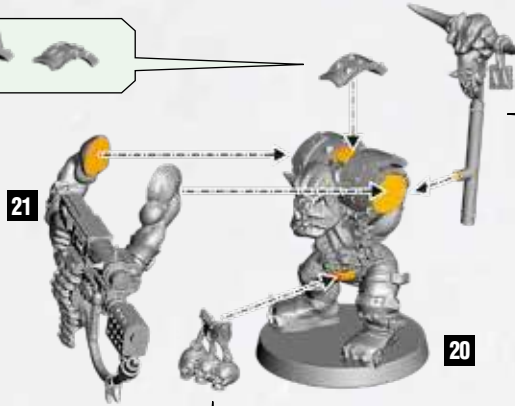

21

20

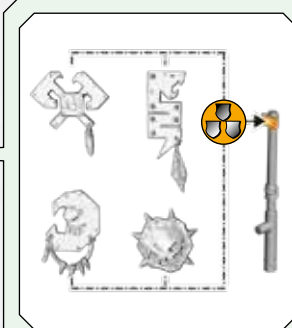
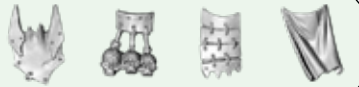

23 a • Boss Nob • 強蛮人头目 • ポスノブ

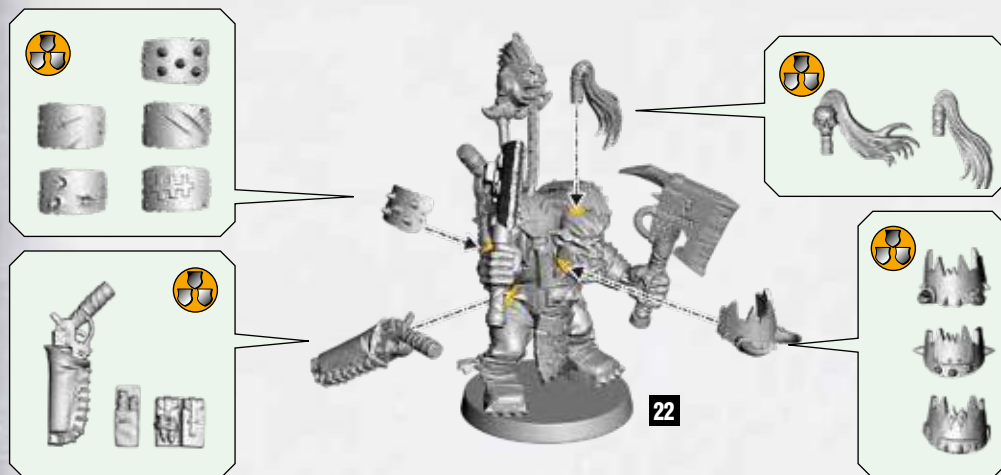

24 a • Ammo Runt • 弾薬尻精
• アーモラント



24 b



24 c

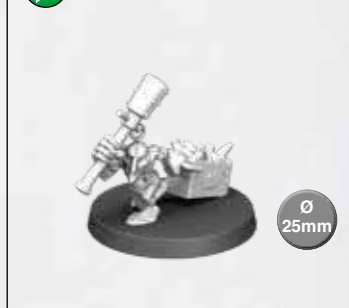

25 - 39

ORK MEGANOBZ

• Ork Meganobz • 欧克重甲强蛮人 • オルク・メガノブ

25 a

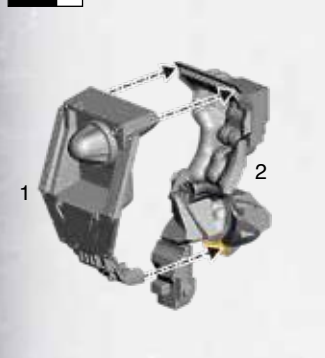

25 b

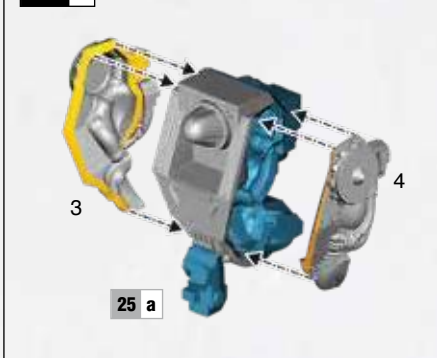

25 c

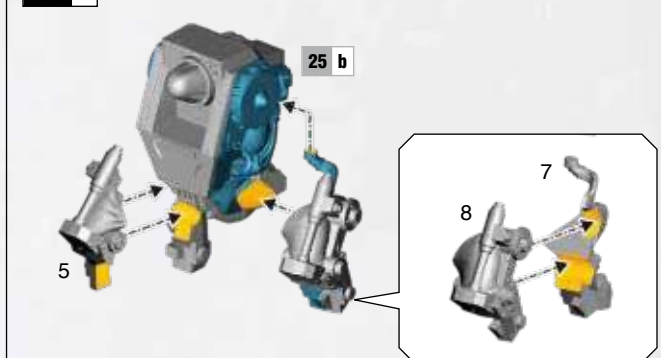

25 d

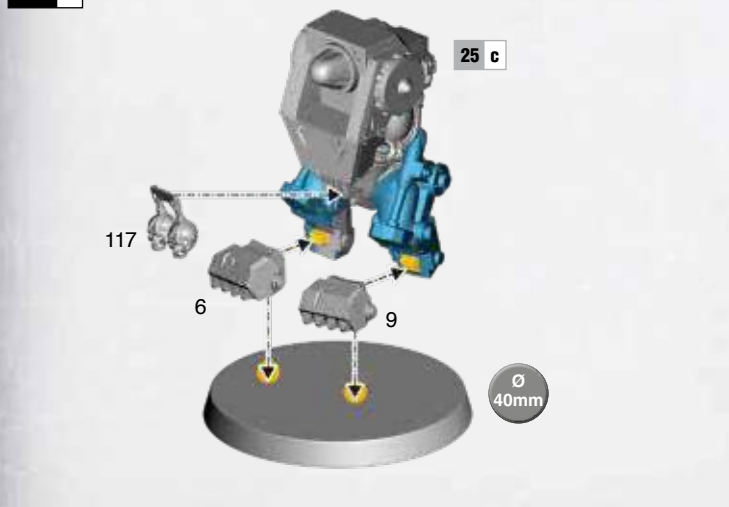

26 a

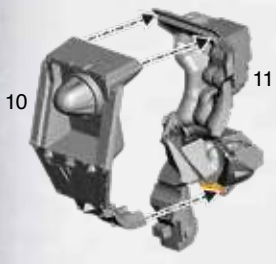

26 b

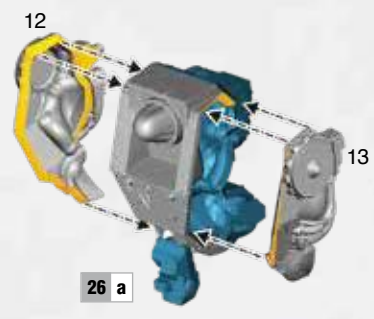

26 c

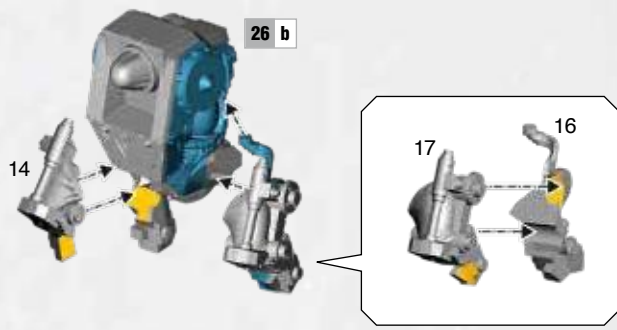

26 d

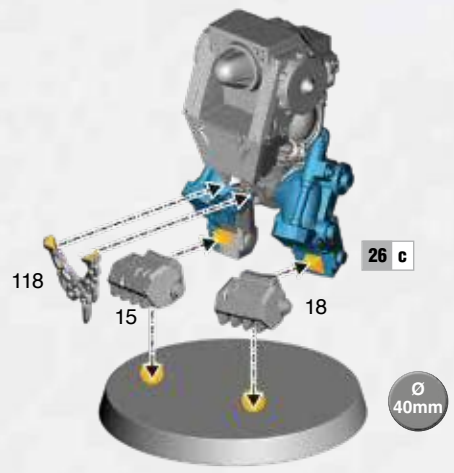

27 a

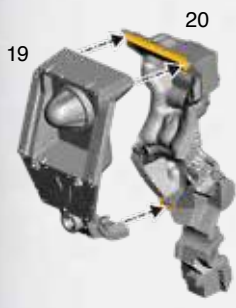

27 b

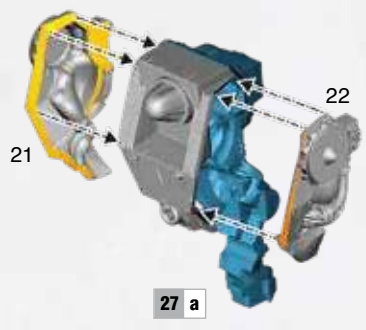

27 c

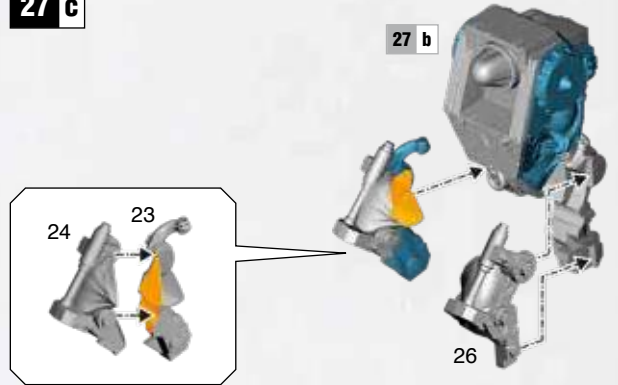

27 d

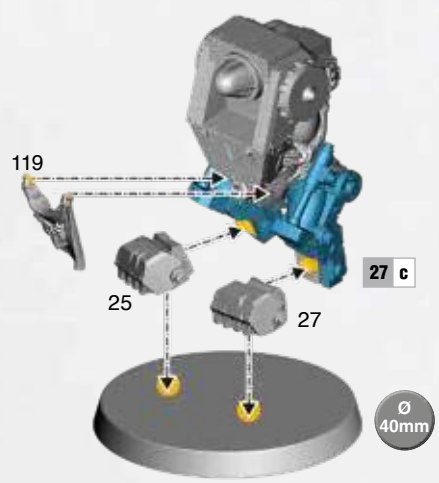

CHOOSE THE UNIT YOU WANT TO BUILD
 • CHOISISSEZ L'UNITÉ À ASSEMBLER • ESCOGE LA UNIDAD QUE QUIERES MONTAR
 • WÄHLE DIE EINHEIT, DIE DU BAUEN MÖCHTEST • SCEGLI L'UNITÀ CHE VUOI ASSEMBLARE
 选择你想 组装的单位 • 組み立てたいユニットを選択

BIG MEK & MEGANOBZ • 蛮人大技师和重甲强蛮人 • ビッグメク&メガノブ

36 - 37 **x1**, 38 - 39 **x2**



MEGANOBZ • 重甲强蛮人 • メガノブ

38 - 39 **x2**



• INTERCHANGEABLE PARTS • ÉLÉMENTS INTERCHANGEABLES • PARTES INTERCAMBIABLES
 • AUSTAUSCHBARE TEILE • COMPONENTI INTERCAMBIABILI • 可互换的部件 • 交換可能なパーツ

28



29

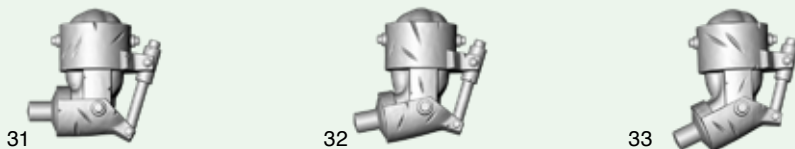

30

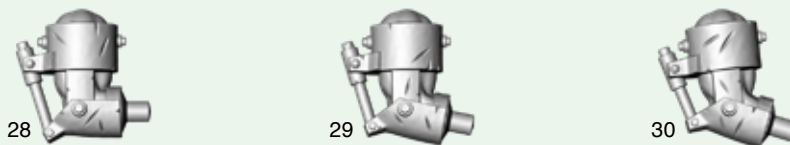

31



32 a

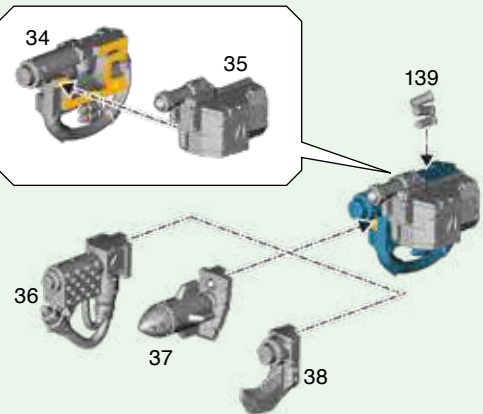

- Kombi weapon with skorcha
- Arme Combinée avec Karbonizator
- Kombi-arma kon kemakema
- Kombiwumme mit Gitbrenna
- kombiarma kon zkotta
- 带有喷火器的双联武器
- コンビスコーチャ



- Kombi weapon with rokkit launcha
- Arme Combinée avec Lance-rokettes
- Kombi-arma kon lanzakohetez
- Kombiwumme mit Bazzukka
- kombiarma kon zparamizzili
- 带有火箭发射器的双联武器
- コンビロキット



- Kustom shoota
- Fling' kustom
- Akribillador personalizado
- Aufgemotztä Wumme
- zpara zumizura
- 強化冲锋枪
- カスタムシュータ

32 b

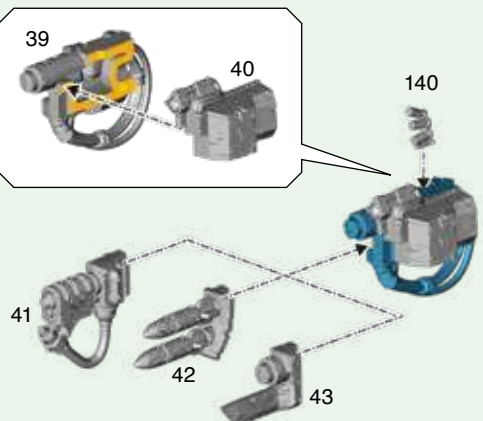

- Kombi weapon with skorcha
- Arme Combinée avec Karbonizator
- Kombi-arma kon kemakema
- Kombiwumme mit Gitbrenna
- kombiarma kon zkotta
- 带有喷火器的双联武器
- コンビスコーチャ



- Kombi weapon with rokkit launcha
- Arme Combinée avec Lance-rokettes
- Kombi-arma kon lanzakohetez
- Kombiwumme mit Bazzukka
- kombiarma kon zparamizzili
- 带有火箭发射器的双联武器
- コンビロキット



- Kustom shoota
- Fling' kustom
- Akribillador personalizado
- Aufgemotztä Wumme
- zpara zumizura
- 強化冲锋枪
- カスタムシュータ

32 c

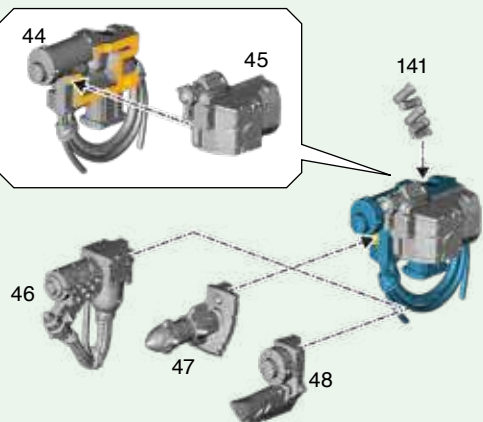

- Kombi weapon with skorcha
- Arme Combinée avec Karbonizator
- Kombi-arma kon kemakema
- Kombiwumme mit Gitbrenna
- kombiarma kon zkotta
- 带有喷火器的双联武器
- コンビスコーチャ



- Kombi weapon with rokkit launcha
- Arme Combinée avec Lance-rokettes
- Kombi-arma kon lanzakohetez
- Kombiwumme mit Bazzukka
- kombiarma kon zparamizzili
- 带有火箭发射器的双联武器
- コンビロキット



- Kustom shoota
- Fling' kustom
- Akribillador personalizado
- Aufgemotztä Wumme
- zpara zumizura
- 強化冲锋枪
- カスタムシュータ

32 d

• Big Mek
• 蛮人大技师 • ビッグメク

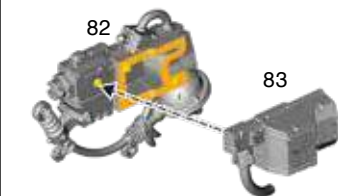

- Kuston mega-blaster
- Méga-klateur kustom
- Mega pipa ezpezial
- Aufgemotzta Mega-Blasta
- Megazkoppia zumizura
- 自制超级爆枪
- カスタム・メガブラスタ

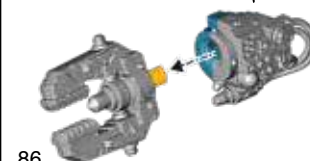
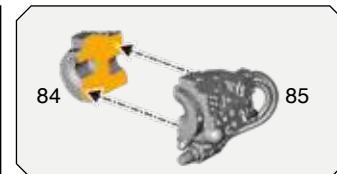

- Power klaw
- Pince énergetik'
- Garra de combate
- Energiekrallä
- kela potenziata
- 能量爪
- パワークロー

• Power claw • Pincas kitu • Garraz de kombate • Energiekrallä • Kela potenziata • 能量爪 • パワークロオ

33 a

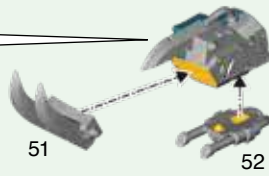

33 a

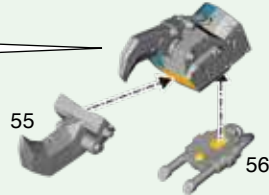
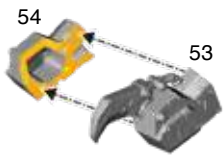

33 a

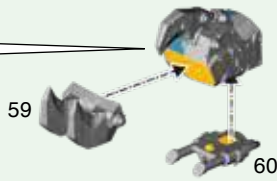
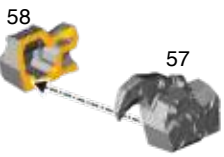

• Killsaws • Diskeuz' • Motozierraz • Killasägä • Zeghe azzazine • 杀戮锯 • プチ殺りノコギリ

34 a

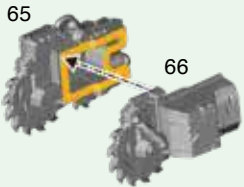

34 b



34 c

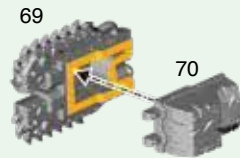

35 a

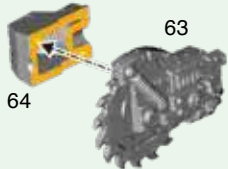

35 b

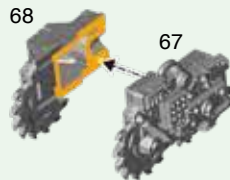

35 c

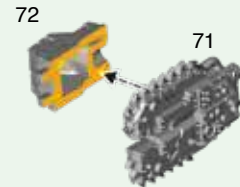

36 a

• Big Mek • 蛮人大技师 • ビッグメク



36 b



36 c



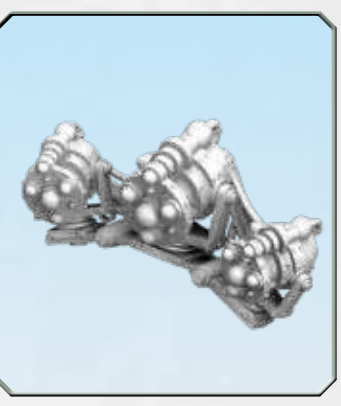
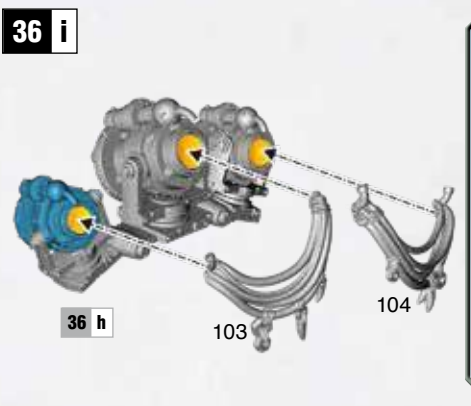
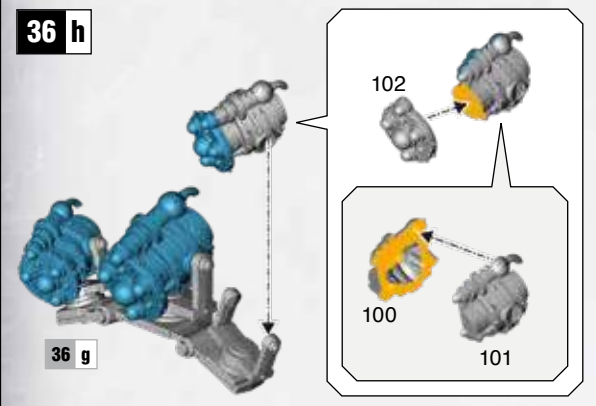
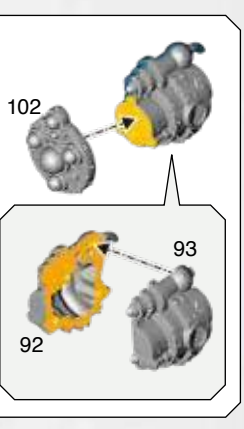
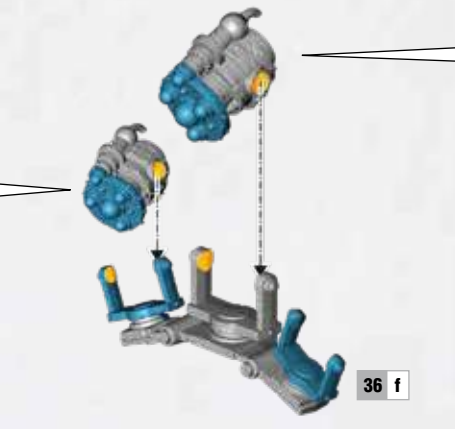
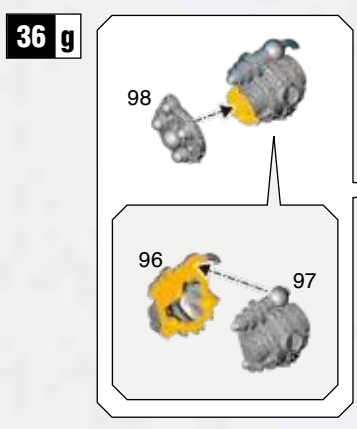
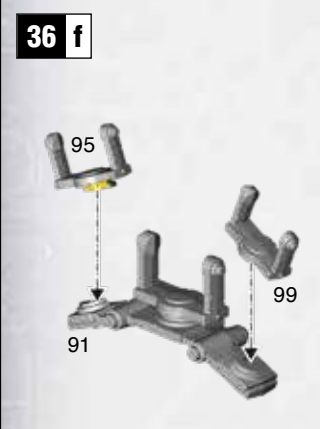
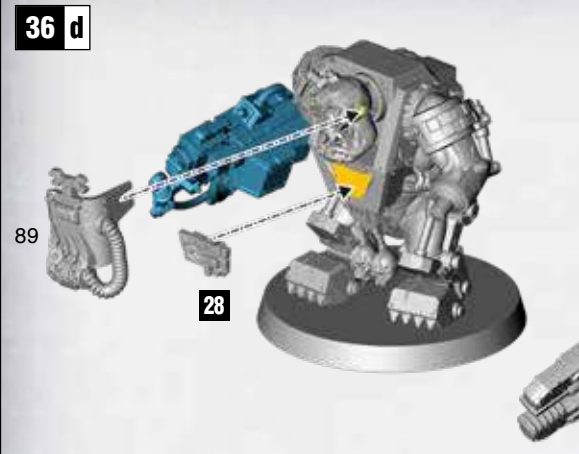

38 a • Meganobz • 重甲強蛮人 • メガノブ

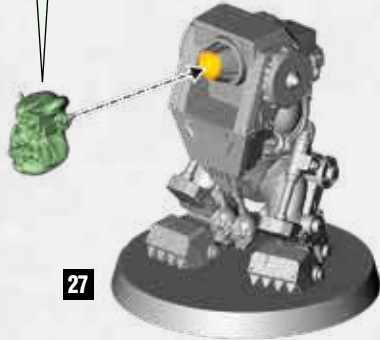

27

38 b

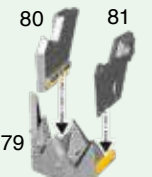
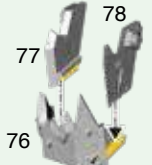
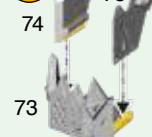

38 a

38 c



38 b

38 d



29

38 c

38 e



30

38 d

38 f

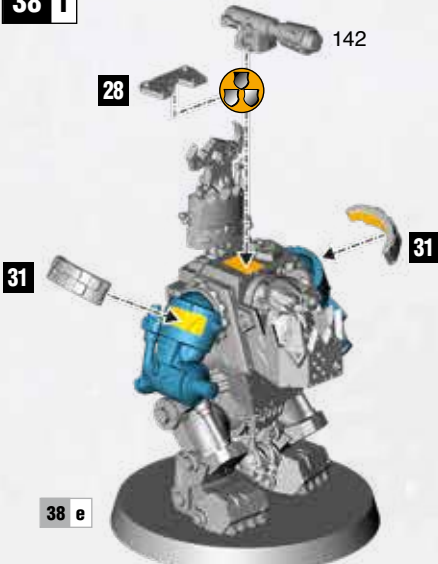

28

142

31

31

38 e





- CHOOSE THE VARIANT YOU WANT TO BUILD
- CHOISISSEZ LA VARIANTE À ASSEMBLER
- ELIGE QUÉ VERSIÓN QUIERES MONTAR
- WÄHLE DIE VARIANTE, DIE DU BAUEN MÖCHTEST
- SCEGLI LA VARIANTE CHE VUOI ASSEMBLARE
- 选择你喜欢的拼装方式
- 組み立てバリエーションの選択

39



39



39 a

Meganob with kombi-weapon with skorcha & power klaw • Meganob avec arme combinée avec Karbonizator & pince énergétique • Meganob con kombi-arma con kemakema y garra de combate
 Meganob mit Kombiwumme mit Gitbrenna & Energiokrallä • Meganob con kombiarma kon zkotta e kela potenziata • 装备带有喷火器的双联武器和能量爪的重甲强蛮人。
 メガノブ(コンビスコーチャ&パワークロオ装備)



39 a

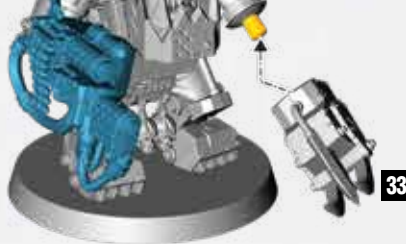

39 a

Meganob with killsaws • Meganob avec diskeuz' • Meganob con motozierraz • Meganob mit Killasägän • Meganob con zeghe azzazine
 装备杀戮锯的重甲强蛮人。メガノブ(ブチ殺りノコギリ装備)

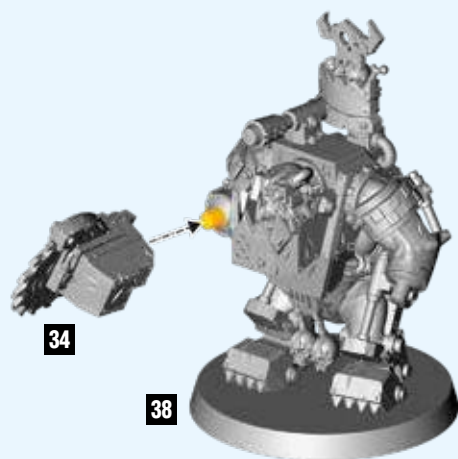

39 a



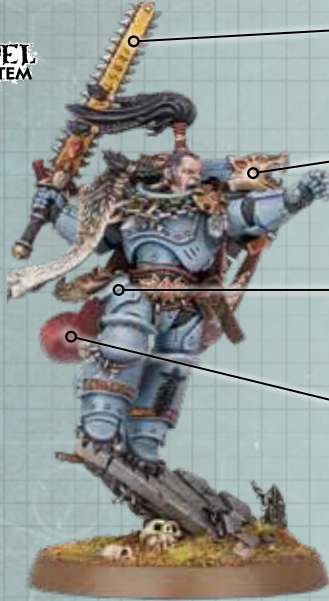

BASE **AVERLAND SUNSET**

SHADE **CASANDORA YELLOW**

LAYER **YRIEL YELLOW**

LAYER **SCREAMING SKULL**

BASE **BALTHASAR GOLD**

SHADE **AGRAX EARTHSHADE**

LAYER **RUNELORD BRASS**

LAYER **STORMHOST SILVER**

BASE **THE FANG**

SHADE **AGRAX EARTHSHADE**

LAYER **RUSS GREY**

LAYER **FENRISIAN GREY**

BASE **KHORNE RED**

SHADE **CARROBURG CRIMSON**

LAYER **WAZDAKKA RED**

LAYER **TUSKGOR FUR**

BASE **WAAAGH! FLESH**

SHADE **BIEL-TAN GREEN**

LAYER **SKARSNIK GREEN**

LAYER **NURGLING GREEN**

BASE **KHORNE RED**

SHADE **NULN OIL**

LAYER **EVIL SUNZ SCARLET**

LAYER **FIRE DRAGON BRIGHT**

BASE **RHINOX HIDE**

LAYER **TALLARN SAND**

LAYER **USHABTI BONE**

LAYER **SCREAMING SKULL**

BASE **ABADDON BLACK**

LAYER **DARK REAPER**

LAYER **DAWNSTONE**

LAYER **ADMINISTRATUM GREY**



BASE **MORGHAST BONE**

SHADE **SERAPHIM SEPIA**

LAYER **USHABTI BONE**

LAYER **SCREAMING SKULL**

BASE **RAKARTH FLESH**

SHADE **AGRAX EARTHSHADE**

LAYER **PALLID WYCH FLESH**

LAYER **WHITE SCAR**

BASE **LEADBELCHER**

SHADE **NULN OIL**

LAYER **IRONBREAKER**

LAYER **STORMHOST SILVER**

BASE **BARAK-NAR BURGUNDY**

SHADE **NULN OIL**

LAYER **WAZDAKKA RED**

LAYER **KARAK STONE**

