

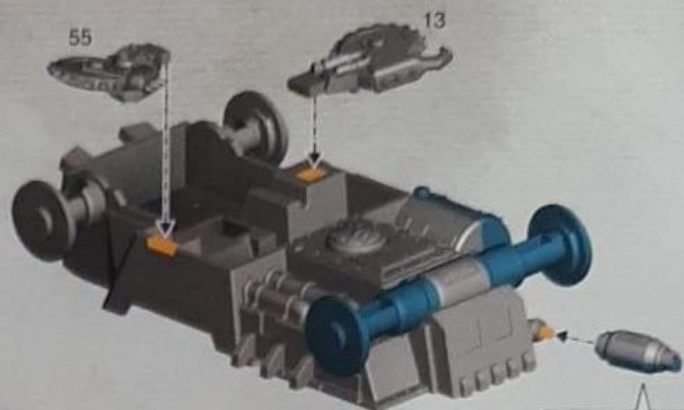

Free Downloads of Build Instructions,
Assembly Booklets & How To Guides

BuildInstructions.com

1 a



1 b

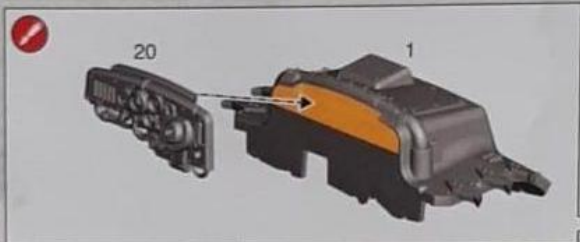

1 c

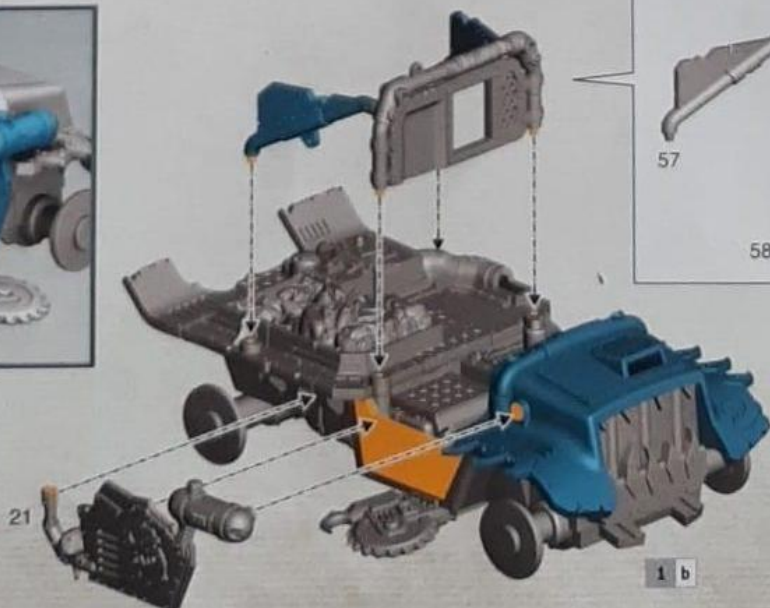

1 b

1 d

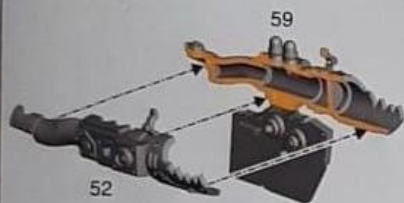
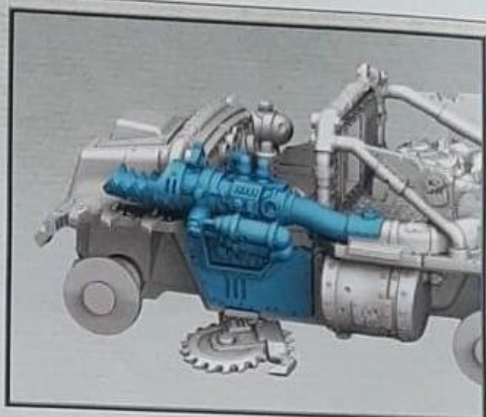
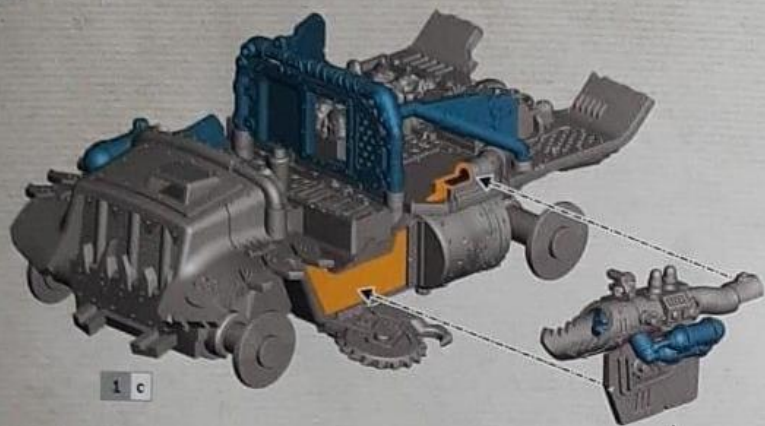

1 e

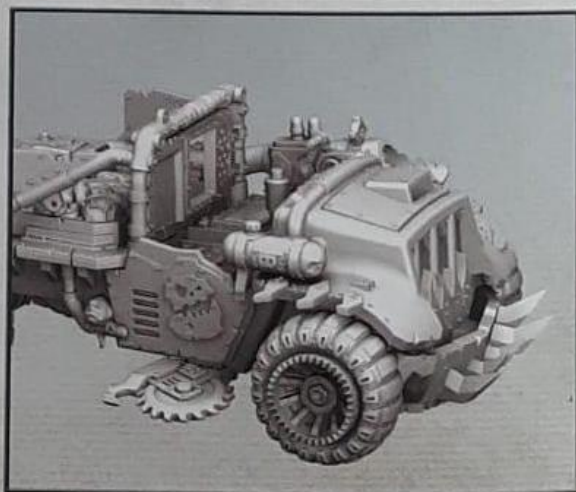
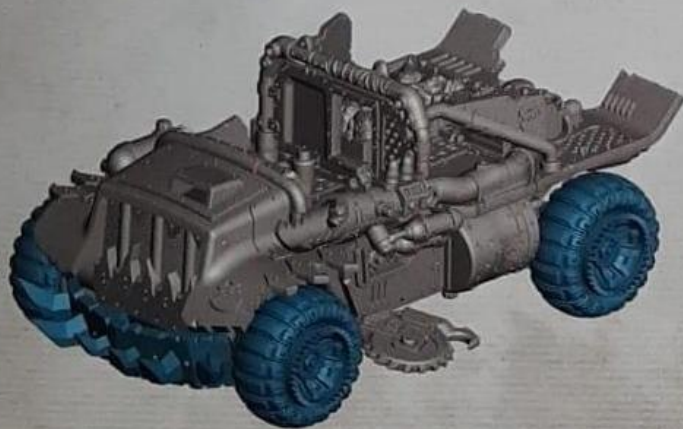
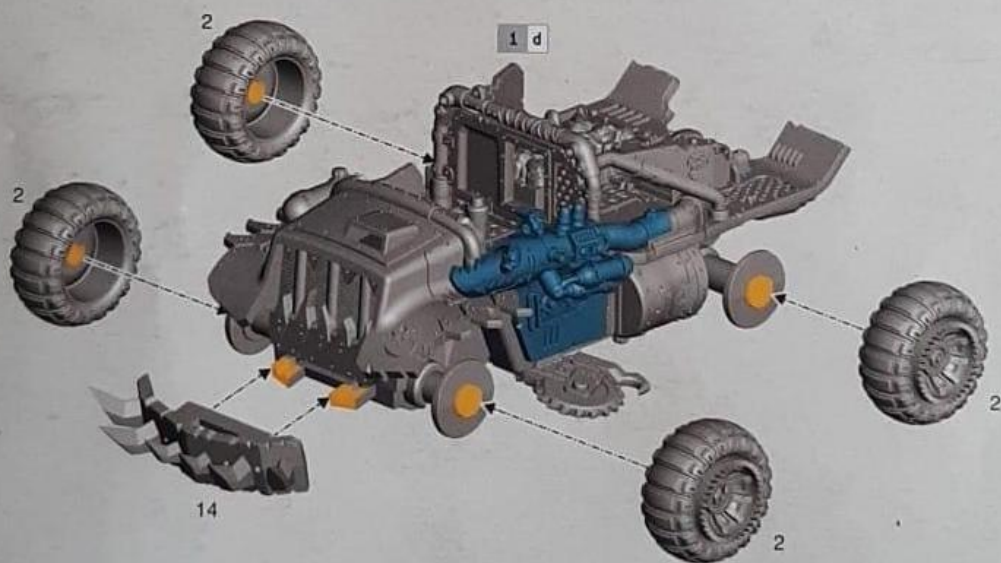

2 a

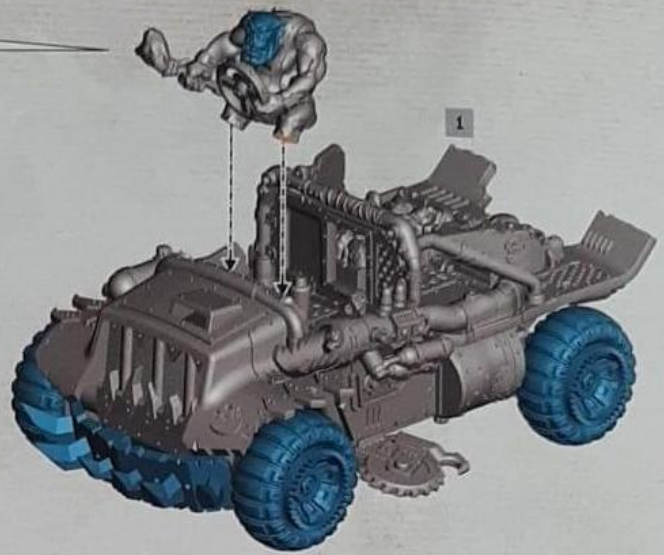
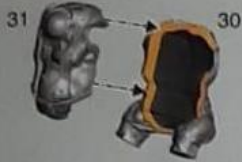

2 b

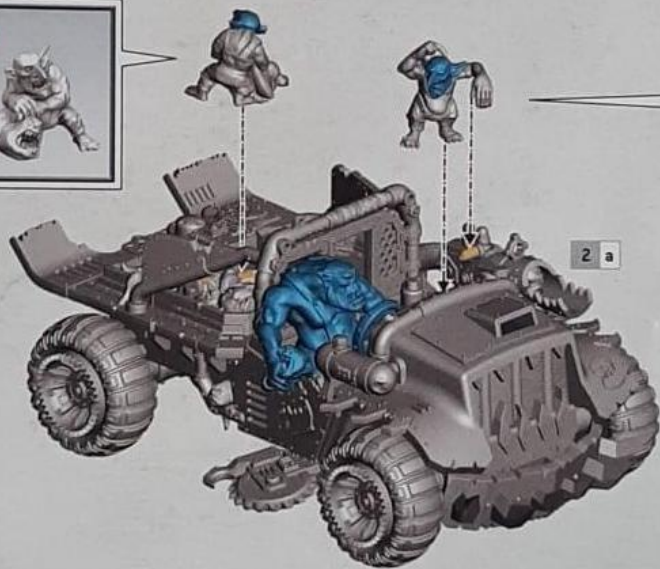
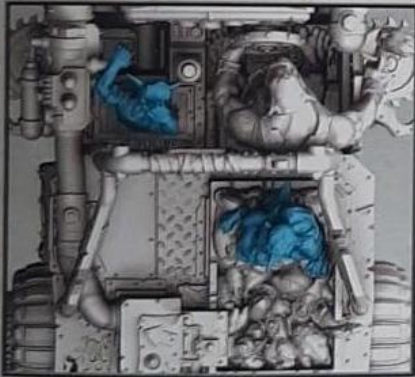
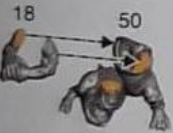

2 c

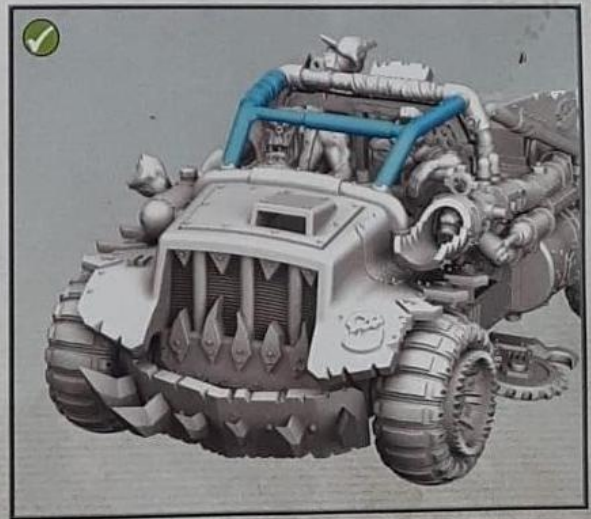
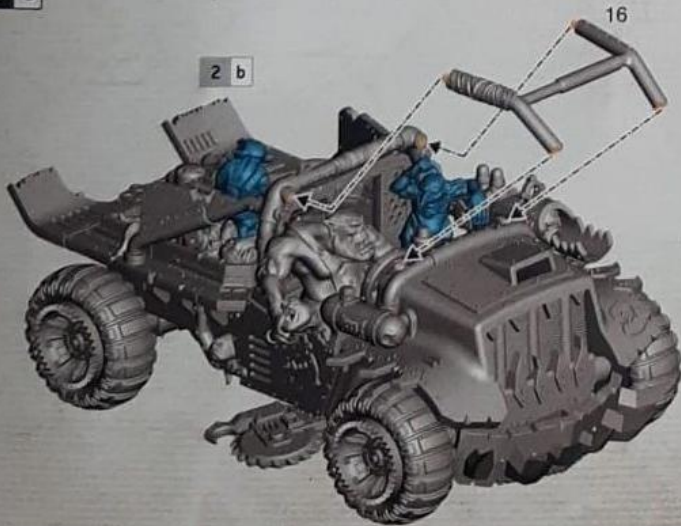

3 a

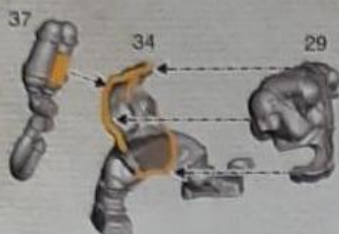

3 b



4 a

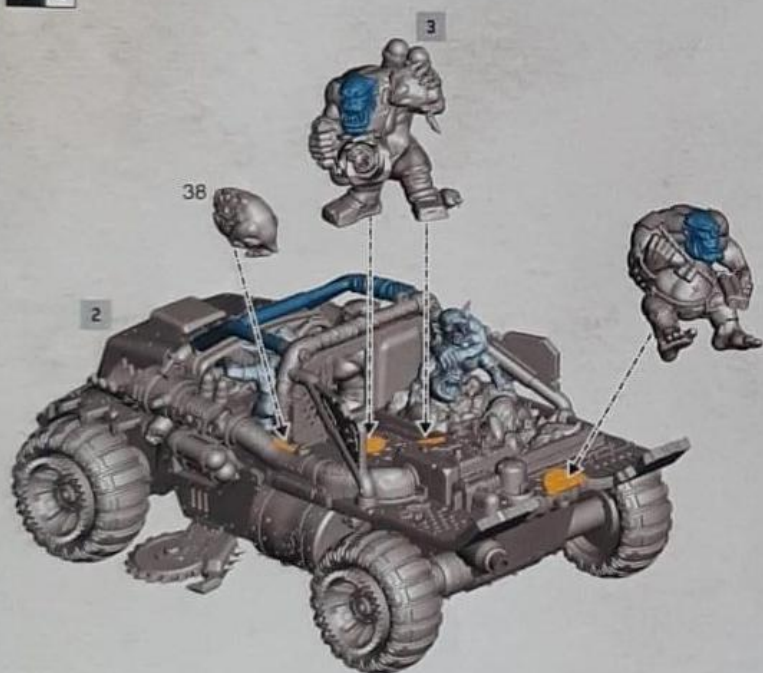

4 b



12



19



25





Ø 160mm

ENG Used alongside the core rules found on warhammer40000.com, the essential rules below will get your new unit on the battlefield. For the full rules for this unit, see the Codex relevant to your army.

FRA Utilisées avec les règles de base de warhammer40000.com les règles essentielles ci-dessous vous permettront de jouer votre nouvelle unité sur le champ de bataille. Pour les règles complètes de cette unité, référez-vous au Codex correspondant à votre armée.

ESP Usadas junto a las reglas básicas que encontrarás en warhammer40000.com, las siguientes reglas esenciales pondrán tu nueva unidad en el campo de batalla. Para ver las reglas completas de esta unidad, consulta el Codex de tu ejército.

GER Wenn du die Regeln unten zusammen mit den Grundregeln auf warhammer40000.com verwendest, kannst du deine Einheit direkt auf das Schlachtfeld führen. Die vollständigen Regeln für diese Einheit findest du im entsprechenden Codex für deine Armee.

ITA Usate assieme alle regole base che puoi trovare su warhammer40000.com, le regole essenziali in basso ti aiuteranno a portare sul campo di battaglia la tua nuova unità. Per le regole complete di questa unità, consulta il Codex corrispondente alla tua armata.

CHN warhammer40000.com 上掲載されているコアルールとともに以下のユニット用基本ルールを使用することで、このユニットを戦場に配備することができます。このユニットの完全版ルールについては、このユニットが属するアーミーのコデックスを参照してください。

JPN 下方的基本規則需搭配 warhammer40000.com 上的《核心規則》使用，可助您将新单位部署到战场上。有关该单位的完整规则，请参见与您的军队相关的《圣典》。

RUKKATRUKK SQUIGBUGGY | BUGGY FOURRE-SQUIGS | GARRAPATONETA | FRESSBUDEN-SQUIGBUGGY | FUORIZTRADA SQUIGBUGGY | ラッカトラック・スクイッグバギー | 跳坑越野战车

Rukkattrukk Squigbuggy	10"	4+	5+	5	6	9	4	7	4+
1									
2									
3									
4									

1	36"	▲ 206	5	-2	2
2	12"	▲ 2	4	0	1
3	18"	▲ 06	5	-2	2
4	×	×	+2	-2	2



warhammer.com
 Games Workshop Limited, Willow Road, Nottingham, NG7 2WS, UK
 © Copyright Games Workshop Limited 2021.

