



Free Downloads of Build Instructions,  
Assembly Booklets & How To Guides

**BuildInstructions.com**

# NECROMUNDA

## ESCHER CUTTERS

**! READ THIS FIRST:** Before assembling your model kit, please read through the instructions in this booklet carefully. A pair of plastic cutters is required to remove the plastic components in this kit from their frame. We advise using a mouldline scraping tool to clean up the parts. To assemble your model, you will need plastic glue. Games Workshop sells Citadel Fine Detail Cutters, Citadel Mouldline Removers and Citadel Plastic Glue, but does not recommend these products for use by children under the age of 16 without adult supervision.

**! À LIRE EN PREMIER :** Avant de vous lancer dans l'assemblage de ce kit, veuillez lire attentivement les instructions de ce livret. Une pince coupante est requise pour détacher chaque élément de sa grappe. Nous vous recommandons l'utilisation d'un grattoir pour ébarber les éléments. Pour l'assemblage, vous aurez également besoin de colle plastique. Games Workshop commercialise les Pinces de Précision Citadel, l'Ébarboir Citadel et la Colle Plastique Citadel, mais n'en recommande pas l'utilisation pour des enfants de moins de 16 ans sans la supervision d'un adulte.

**! LEER ANTES DE MONTAR:** Antes de montar el contenido de este kit, lee estas instrucciones cuidadosamente. Te harán falta unas tenazas para plástico a fin de separar las piezas de la matriz. También aconsejamos una herramienta para rebabas a fin de limpiar cada pieza. Para montar la miniatura necesitarás pegamento para plástico. Games Workshop vende Tenazas Citadel, Herramientas para rebabas Citadel y Pegamento para plástico Citadel, pero no recomienda estos productos a menores de 16 años sin la supervisión de un adulto.

**! LIES DIES ZUERST:** Bitte lies diese Anleitung sorgfältig, bevor du mit dem Zusammenbau deines Modells beginnst. Du benötigst einen Kunststoffseitenschneider, um die Kunststoffbauteile aus dem Gussrahmen herauszutrennen, und Kunststoffkleber, um die Miniatur zusammenzubauen. Außerdem empfehlen wir, die Bauteile vorher mit einem Gussgratentferner zu säubern. Games Workshop bietet Präzisions-Kunststoffseitenschneider von Citadel sowie Citadel-Kunststoffkleber an, empfiehlt aber, dass Kinder unter 16 Jahren diese nur unter Aufsicht eines Erwachsenen benutzen.

**! LEGGI PRIMA QUESTO:** Prima di assemblare il tuo modello, leggi le istruzioni di questo libretto con attenzione. Sono necessarie un paio di tronchesine per plastica per staccare i componenti dai loro sprue. Consigliamo di usare un attrezzo apposito per pulire i componenti. Per assemblare il modello avrai bisogno di colla per plastica. Games Workshop vende Tronchesine di precisione Citadel, Attrezzo per ripulire Citadel e Colla per plastica Citadel, ma non consiglia questi prodotti ad un pubblico minore di 16 anni senza la supervisione di un adulto.

**! 优先阅读:** 组装模型前, 请先仔细阅读本手册中的说明。需要用模型剪钳将塑料部件从板上剪下。我们推荐使用合模线清理工具来清理零件。用塑料粘接剂来组装模型。Games Workshop 销售 Citadel 精密剪钳、Citadel 合模线刮刀和 Citadel 塑料粘接剂, 但不建议未满 16 岁的儿童在没有成人的监护下使用此类产品。

**! 最初にお読みください:** ミニチュアを組み立てる前に、この冊子の説明をよくお読みください。本セット内フレームからプラスチックパーツを切り取るためにプラスチック用ニッパーが必要となります。その後パーツを滑らかにするため、モールドラインを削るためのツールの使用を推奨します。モデルの組み立てには、プラスチック接着剤が必要となります。ゲームズワークショップでは「シタデルファインディテールニッパー」「シタデルモールドラインリムーバー」「シタデルプラスチック接着剤」を販売していますが、これらは保護者の監督なしでの16歳以下のお子様の使用を推奨しません。

 Choice of parts  
Choix d'éléments  
Modelos de componentes  
Auswahl an Teilen  
Scelta di componenti  
零件选择  
パーツ選択

 Variant assembly  
Variante d'assemblage  
Variante de montaje  
Bauvariante  
Assemblaggio alternativo  
多种组装方案  
組み立てのバリエーション

 Rotate part  
Faire pivoter  
Girar la pieza  
Teil drehen  
Ruota il componente  
旋转部件  
向きを変更

 Detail view  
Vue détaillée  
Vista detallada  
Alternative Ansicht  
Visuale del dettaglio  
局部放大视图  
拡大

 Repeat process  
Répéter l'étape  
Repetir pasos  
Vorgang wiederholen  
Ripeti il componente  
重复步骤  
プロセスを繰り返す

 Stage complete  
Étape terminée  
Paso completado  
Schritt abgeschlossen  
Fase completa  
部件组装完成  
完了

16+



Citadel Plastic Glue  
Colle plastique liquide Citadel  
Pegamento para plástico fluido  
Citadel-Kunststoffkleber  
Colla per plastica fluida Citadel  
Citadel 塑料灌缝粘胶  
シタデルプラスチック接着剤流し込みタイプ



Citadel Fine Detail Cutters  
Pinces de précision Citadel  
Tenazas Citadel  
Präzisions-Kunststoffseitenschneider  
Tronchesine di precisione Citadel  
Citadel 精密剪钳  
シタデルファインディテールニッパー



Citadel Mouldline Remover  
Ebarboir Citadel  
Herramienta para rebabas Citadel  
Gussgratentferner  
Atrezzo per ripulire Citadel  
Citadel 合模线刮刀  
シタデルモールドラインリムーバー

CITADEL

© Copyright 2022 Games Workshop Ltd. All rights reserved.



993105990423

# ESCHER CUTTERS

1

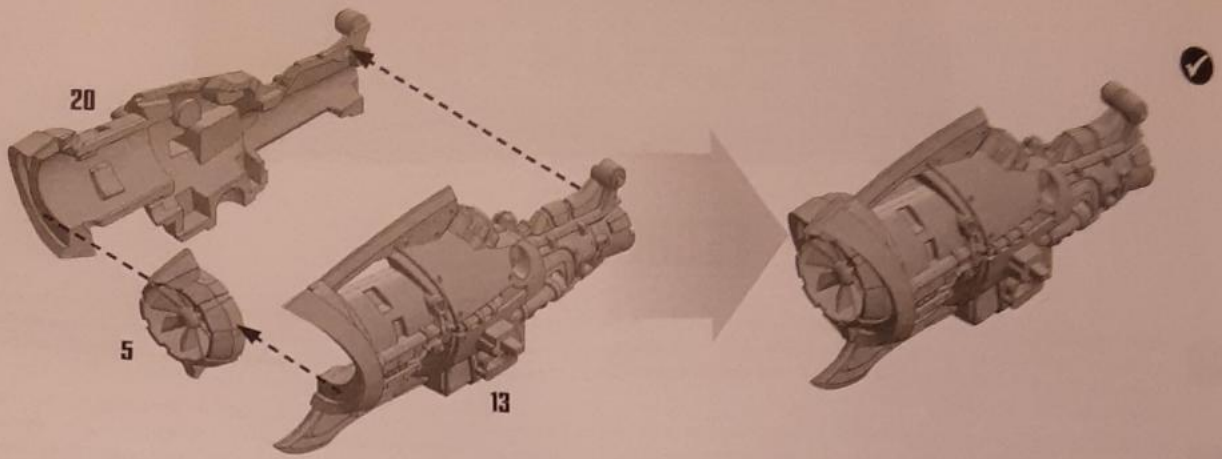

2

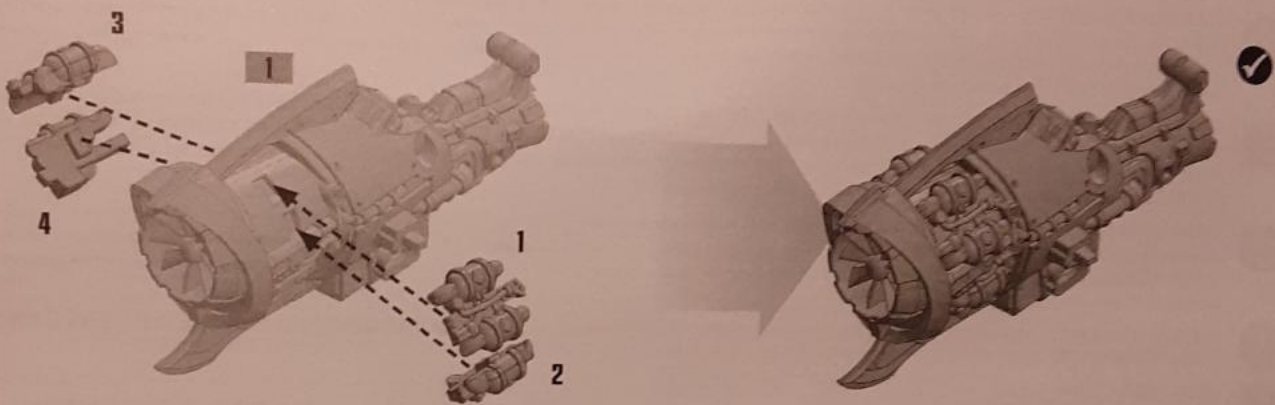

3

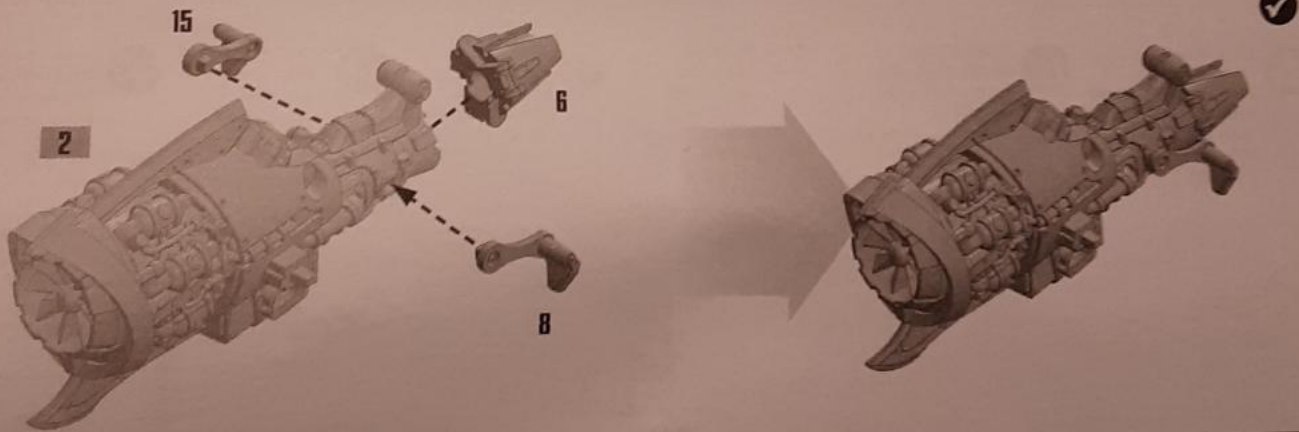

4



GAS TRAP LAUNCHER



**RIGHT HEAVY STUBBER**

**5A**

**16**

**17**



**LEFT HEAVY STUBBER**

**5B**

**10**

**9**



**RIGHT PLASMA GUN**

**6A**

**18**

**19**



**LEFT PLASMA GUN**

**6B**

**12**

**11**



**RIGHT GRENADE LAUNCHER**

**7A**

**27**

**23**

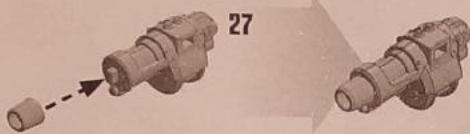

**LEFT GRENADE LAUNCHER**

**7B**

**26**

**23**



**8**

**5A**

**6A**

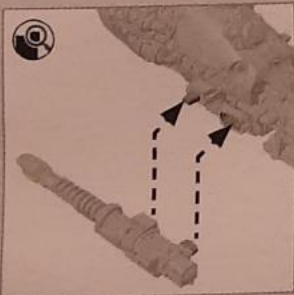
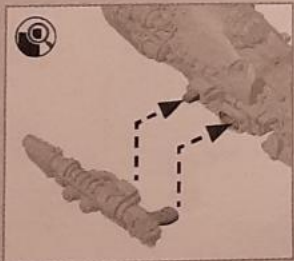
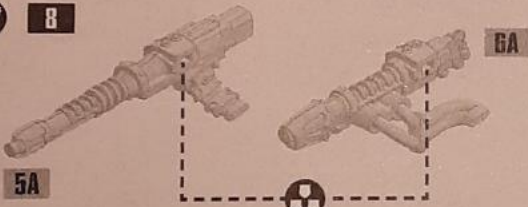

**4**

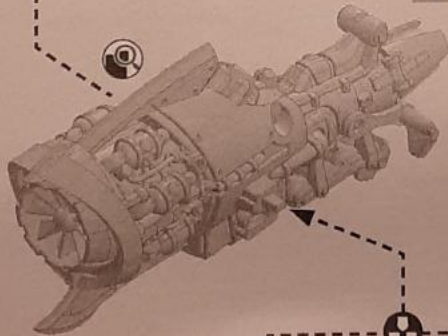

**5B**

**6B**

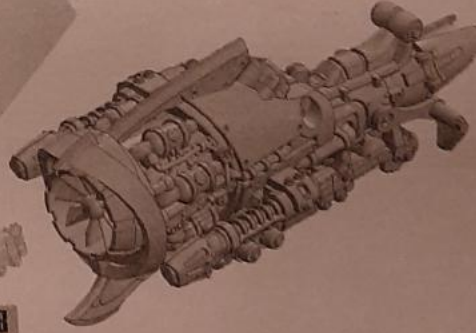
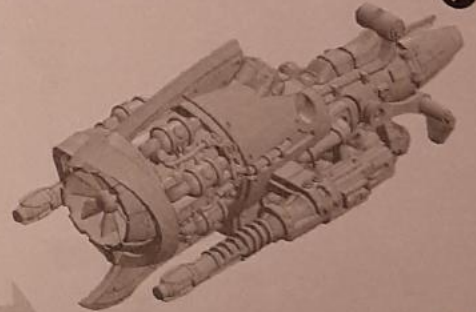
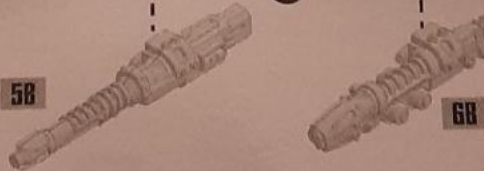

**7A**

**4**

**25**

**24**

**7B**

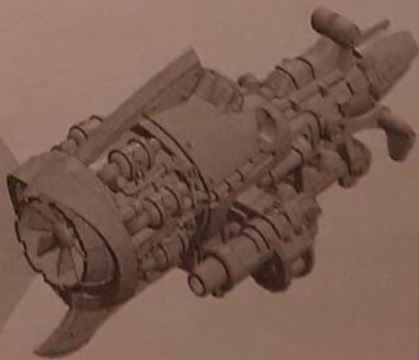
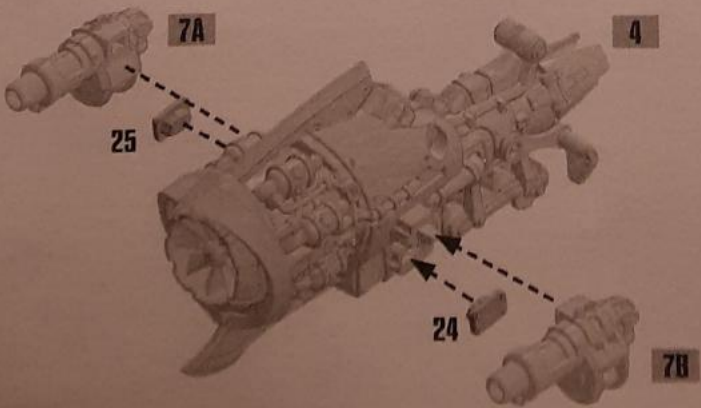

9A

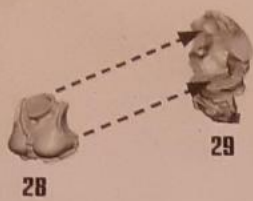

9B

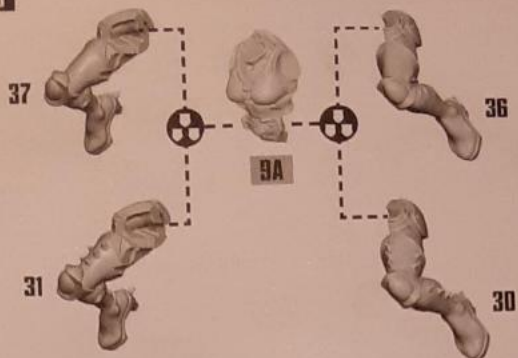

9C

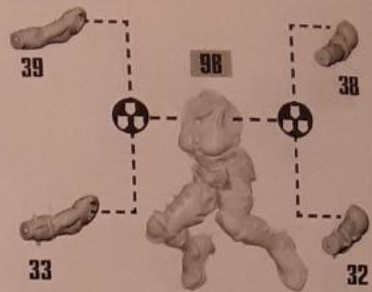

9D

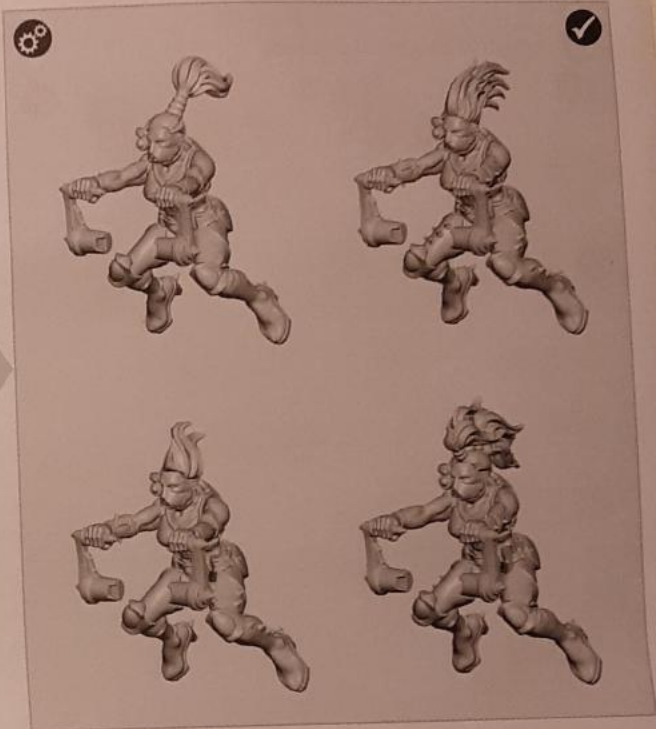
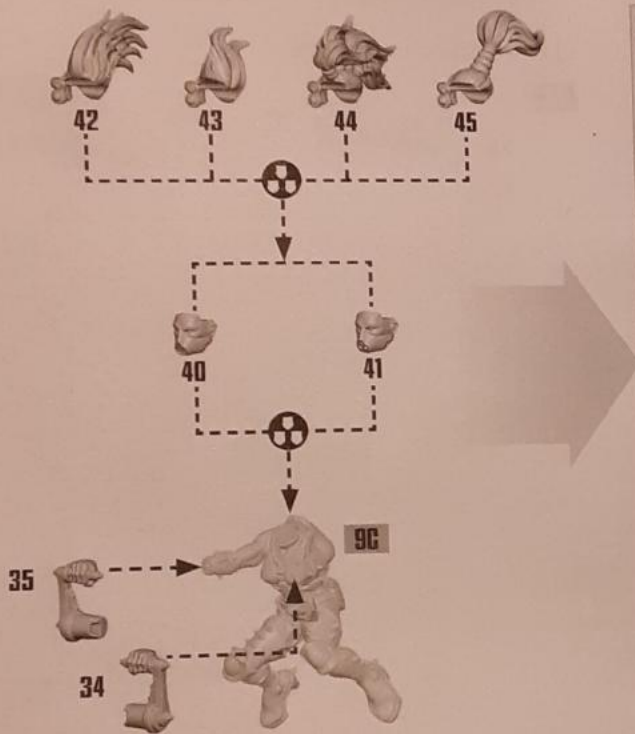

10A

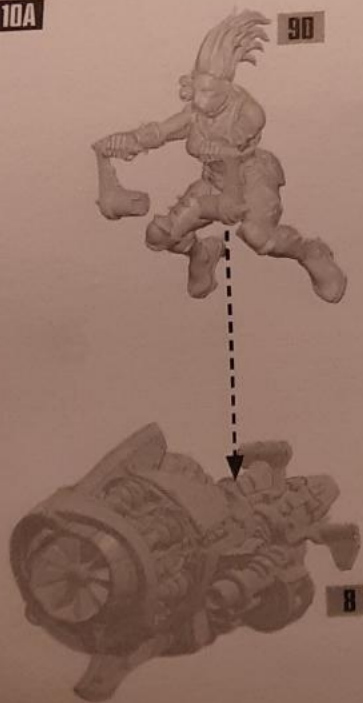

10B

