



Free Downloads of Build Instructions,
Assembly Booklets & How To Guides

BuildInstructions.com

IMPERIAL™ ARMOUR

CASTELLAX BATTLE-AUTOMATA WITH MULTI-MELTA RESIN COMPONENTS LIST

CASTELLAX BATTLE-AUTOMATA WITH MULTI-MELTA

99590108096

1. Left Foot
2. Right Foot
3. Right Foot Raised
4. Upper Torso
5. Right Leg
6. Left Leg
7. Sensor Skull
8. Weapon Mount
9. Lower Torso
10. Multi-Melta
11. Fuel Cell
12. Power Feed
13. Hips
14. Left Flamer
15. Right Flamer
16. Left Bolter
17. Right Bolter
18. Shoulder x2
19. Left Power Blade (check the direction of the blade)
20. Right Power Blade (check the direction of the blade)
21. Right Arm Guard
22. Left Arm Guard
23. Arm 1 *
24. Arm 2 *
25. Arm Mount x2

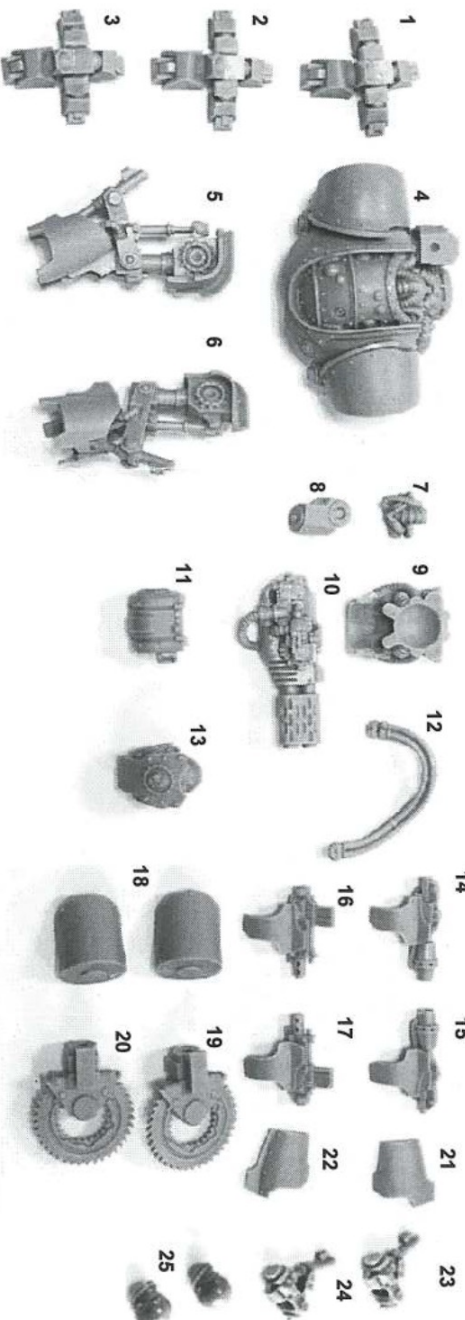

* These items are not sided and can be used for the left or right arm

This kit contains all the pieces required to build the Castellax Battle-Automata with Multi-Melta
To glue the resin pieces together and to plastic kit parts
use Citadel Super Glue.

NOTE: We have cast this kit using the most advanced techniques and the best quality resin, but due to the nature of the casting process your model may contain very slight air bubbles. These can easily be filled with model filler or super glue. Any slight warpage of thin parts can easily be corrected by immersing the part in hot tap water for about 1 minute then carefully bending it back into shape.

THIS IS NOT A TOY

Not suitable for children under 15 years of age.

WARNING: Resin dust can be harmful if inhaled. Always wear a dust mask or respirator when sanding or sawing resin parts.

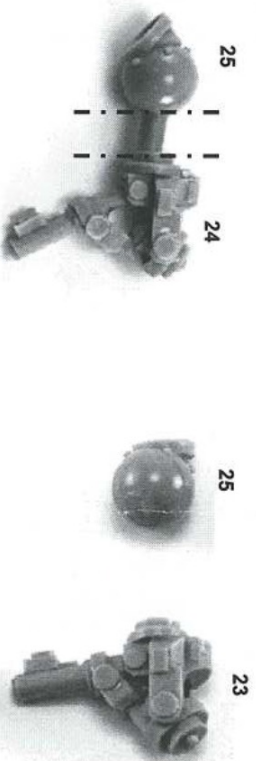

The Arms and Arm Mounts are cast as a single piece. Divide them as shown above

The copyright on the model designs and components within this box is the exclusive property of Games Workshop Ltd. Copyright Games Workshop Ltd., 2014. All rights reserved.

4. Upper Torso

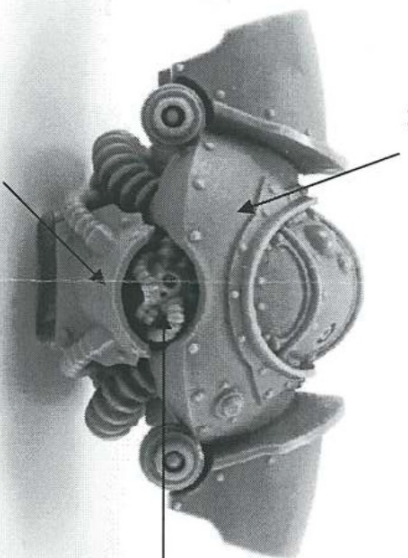

7. Sensor Skull

9. Lower Torso



5. Right Leg

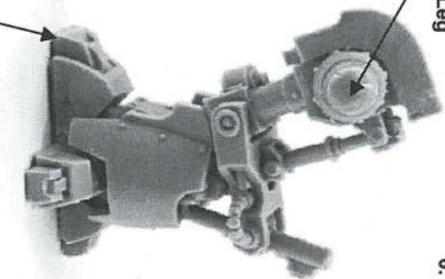

6. Left Leg

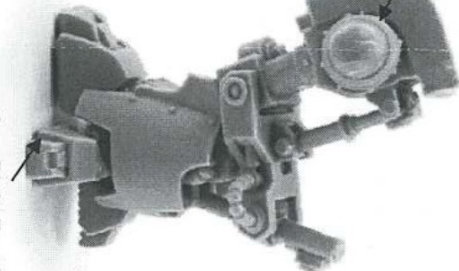

2. Right Foot

3. Right Foot Raised

The right foot has two options available. One for a static pose and a raised one for a walking pose.

10. Multi-Melta



8. Weapon Mount

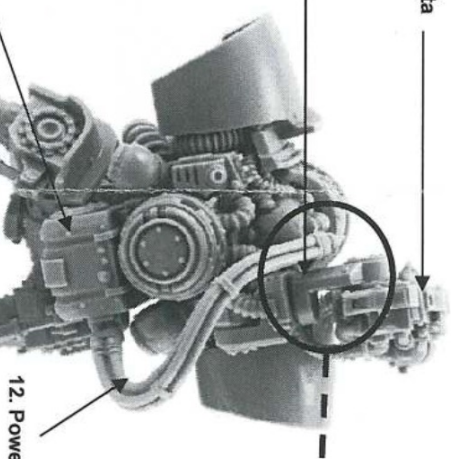

12. Power Feed

11. Fuel Cell

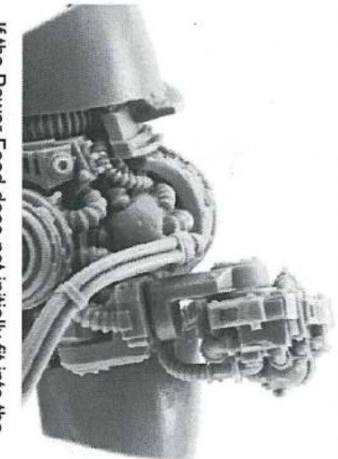
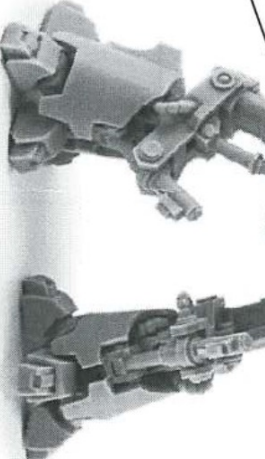

If the Power Feed does not initially fit into the Multi-Melta (as shown above), simply apply some gentle heat to the Power Feed either using a hair dryer or hot water and bend the Power Feed to the Multi-Melta (as shown below)

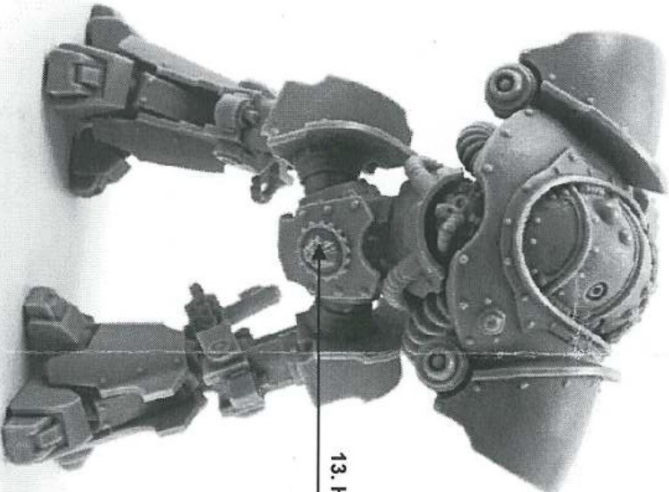
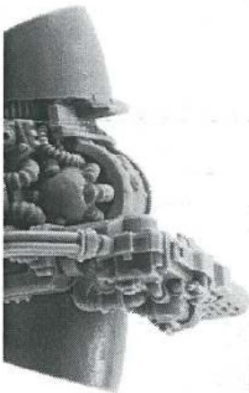

13. Hips

20. Right Power Blade

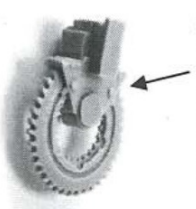

19. Left Power Blade

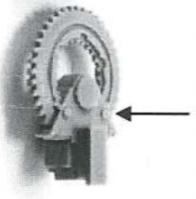

17. Right Bolter

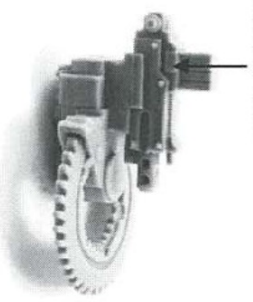

14. Left Flamer

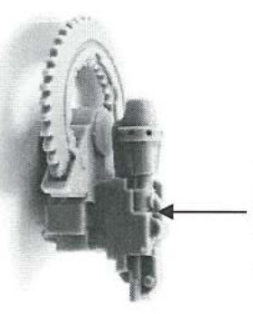

23. Right Arm Guard

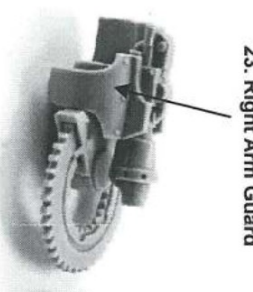

24. Left Arm Guard

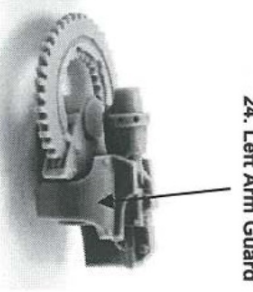

25. Arm Mount

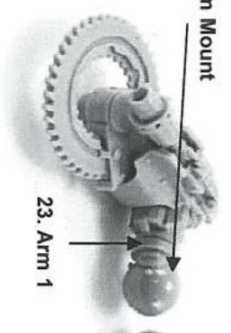

23. Arm 1



25. Arm Mount

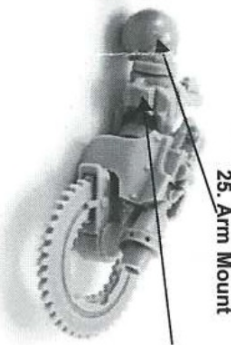

24. Arm 2



18. Shoulder

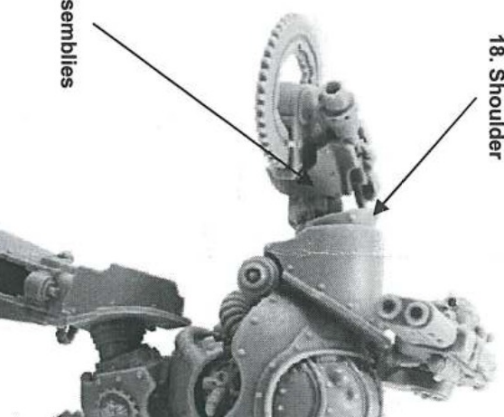

18. Shoulder

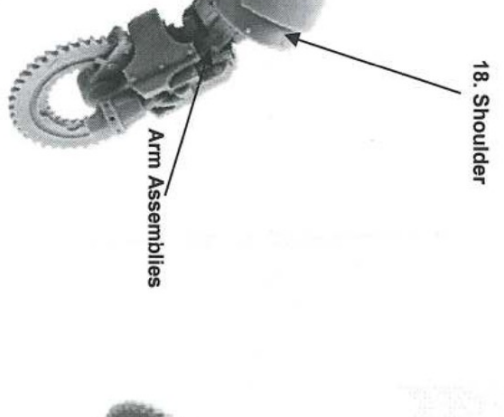

Arm Assemblies

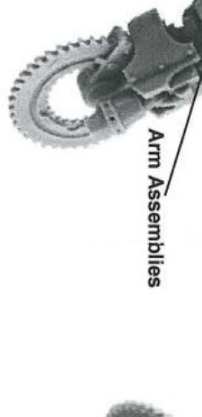

Arm Assemblies

