



Free Downloads of Build Instructions,
Assembly Booklets & How To Guides

BuildInstructions.com



TRIAROS ARMoured CONVEYOR

1a

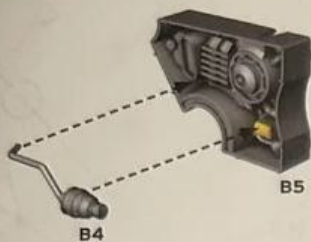

1b

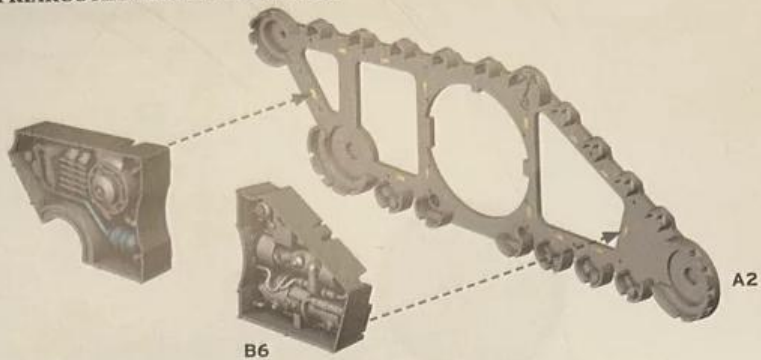

1c

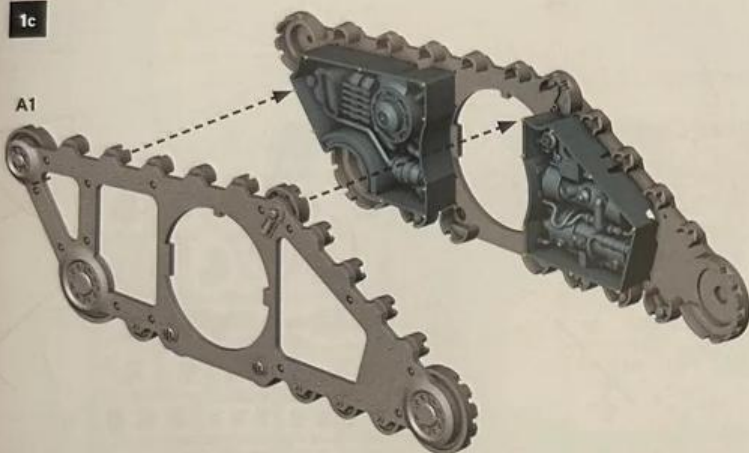

1d

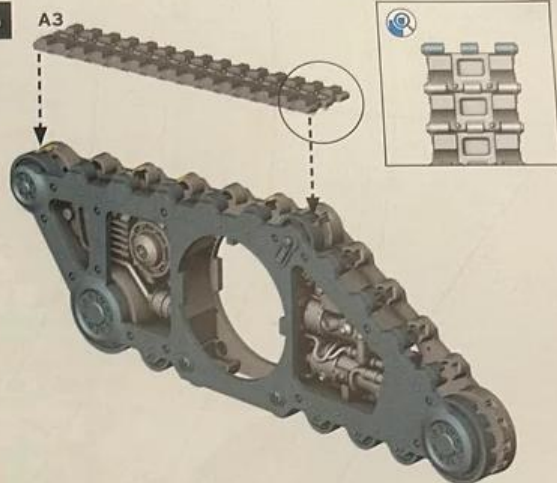

1e

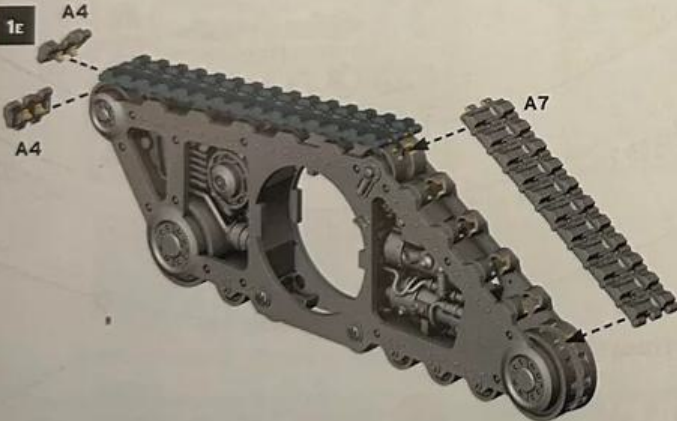

1f

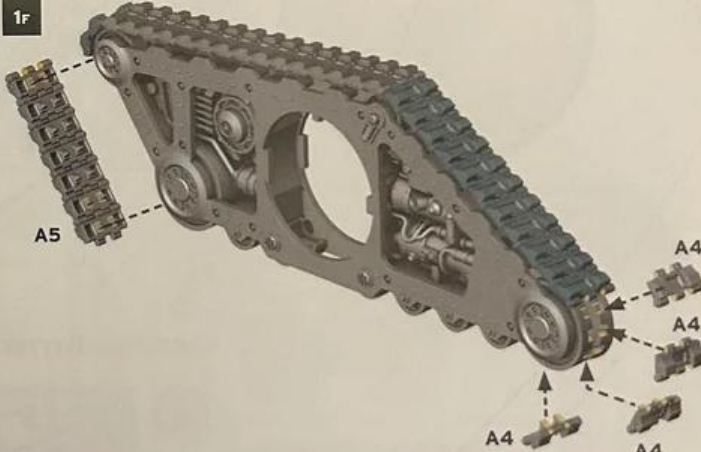

1g

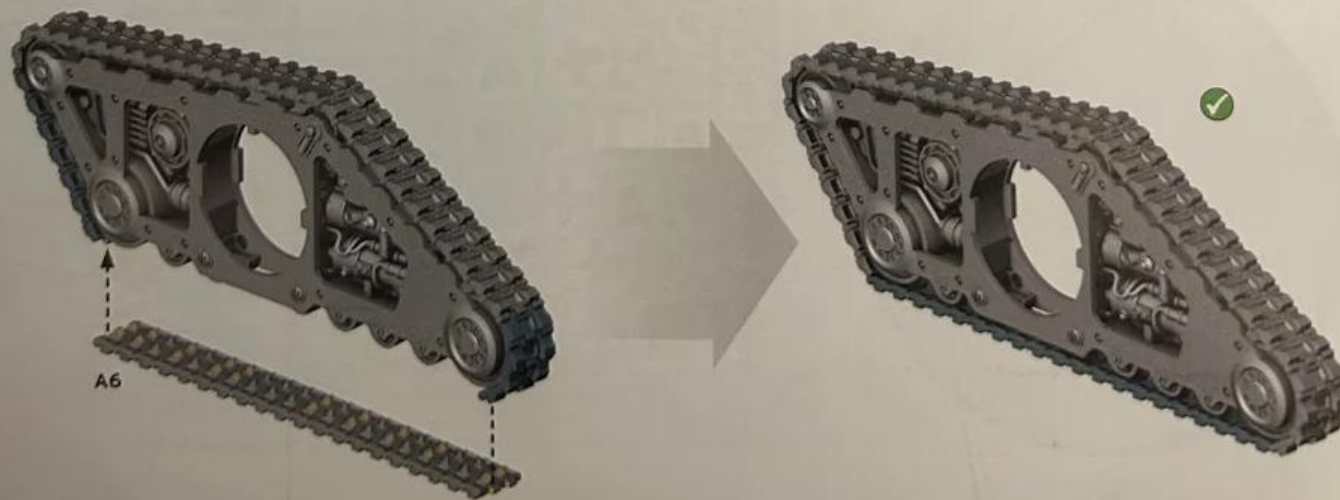

2A

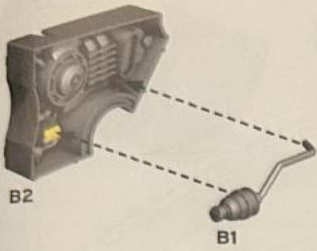

2B

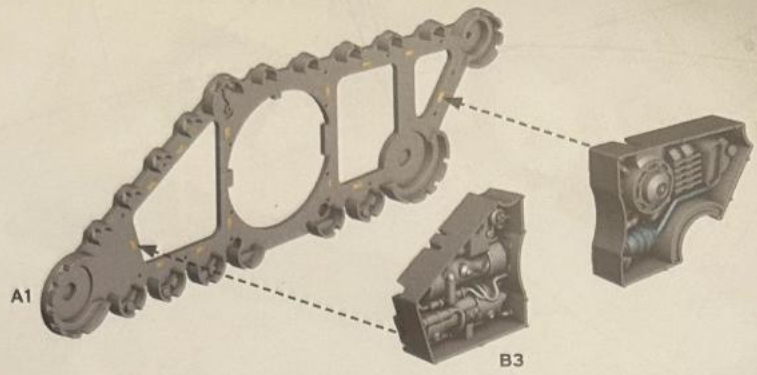

2C

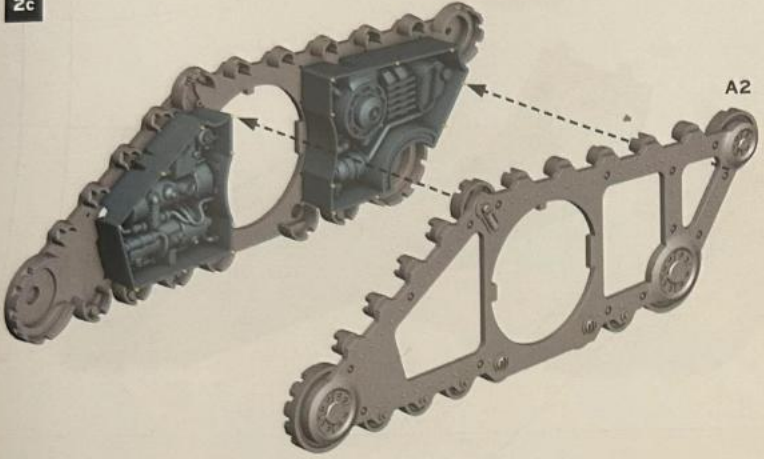

2D

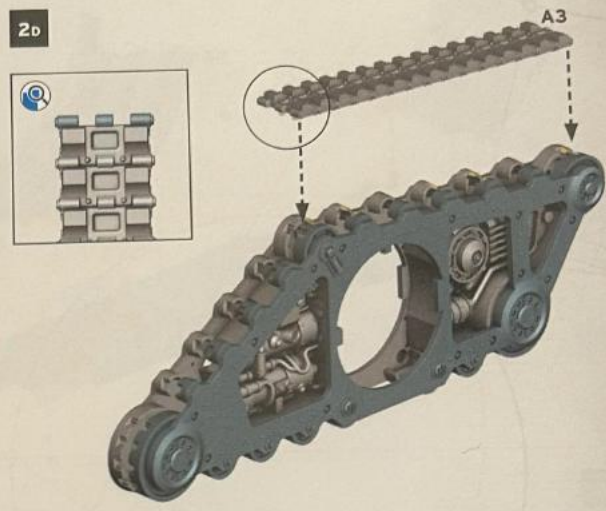

2E

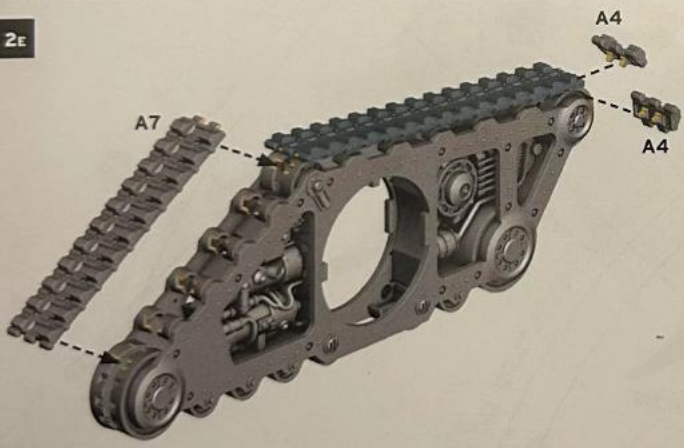

2F

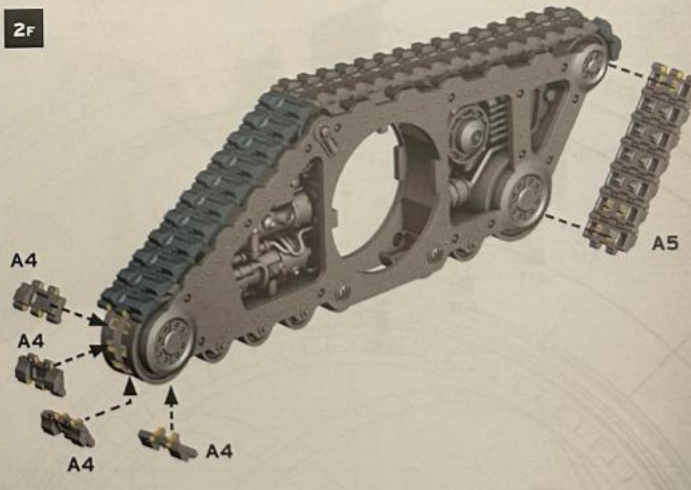

2G

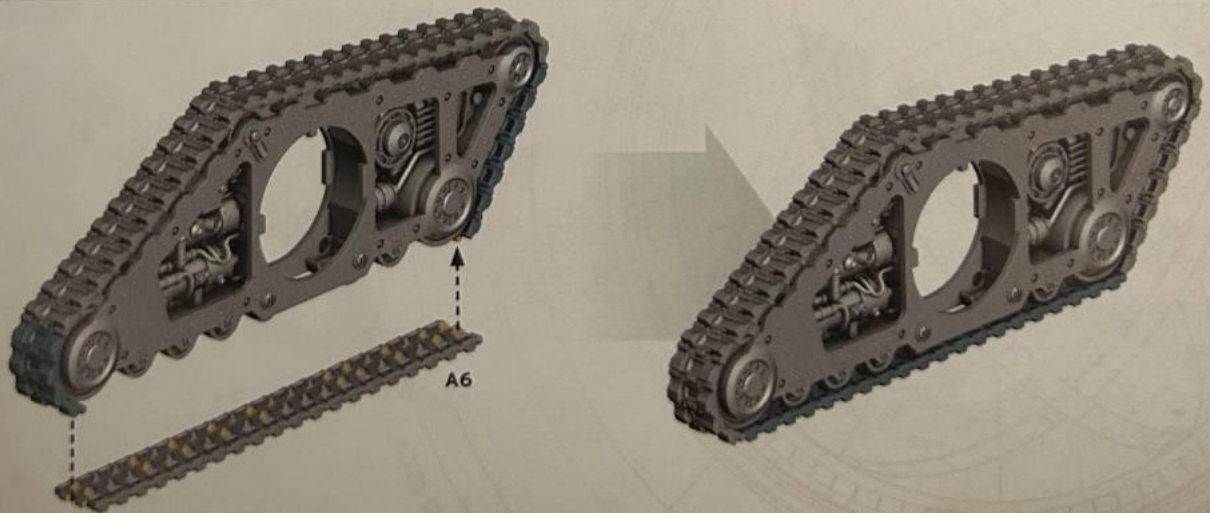

3a

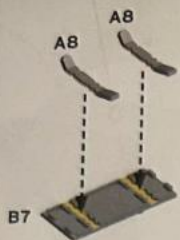

3b

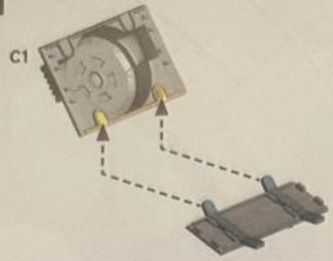

3c

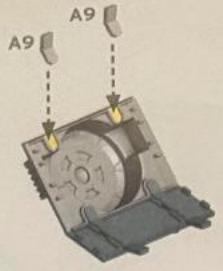

3d

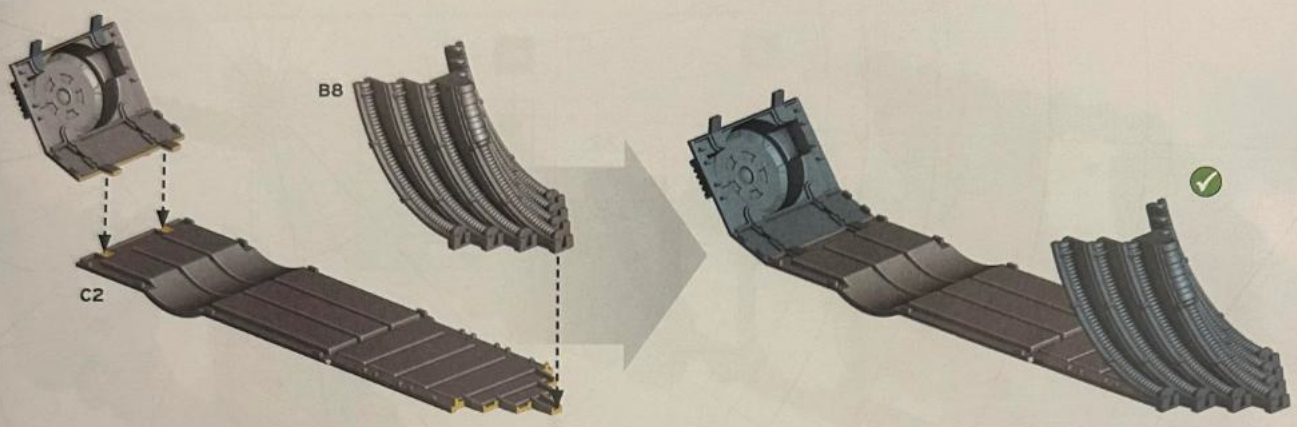

4

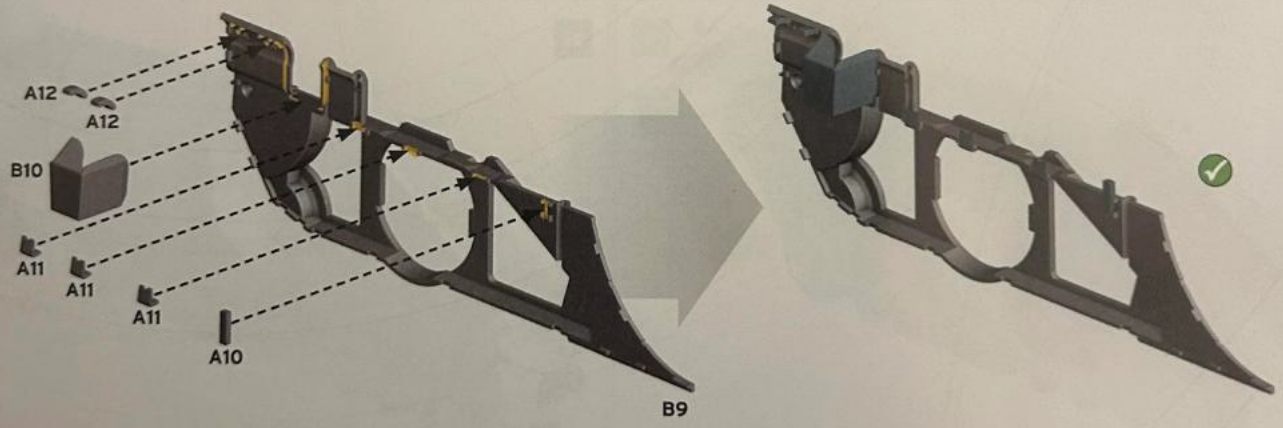

5

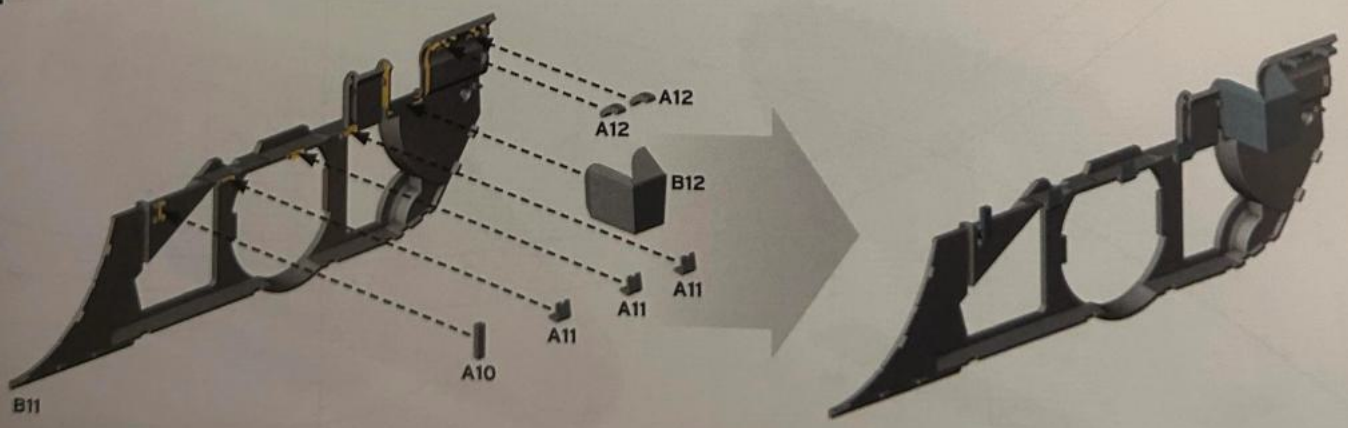

6A

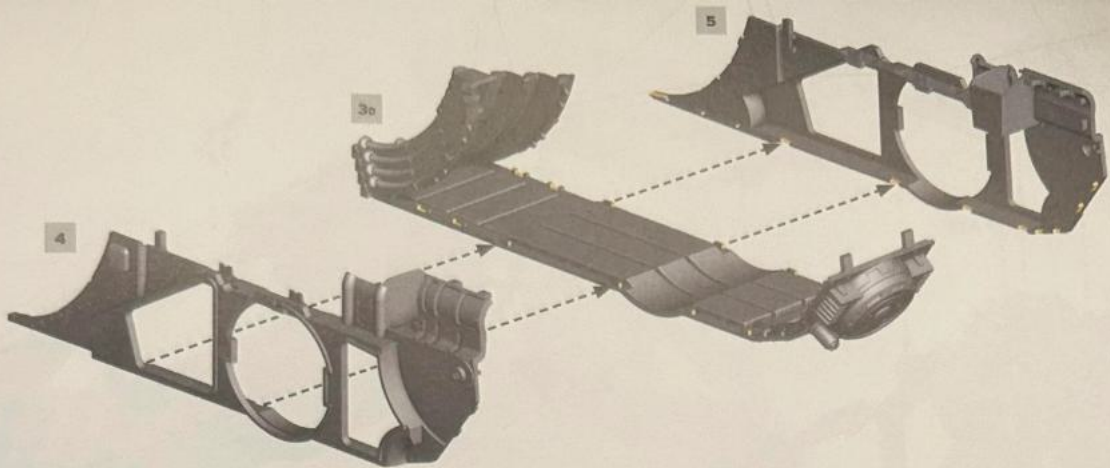

6B



6c

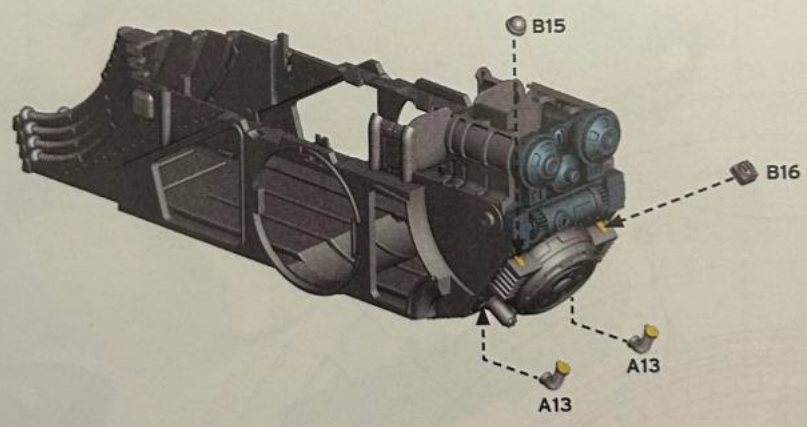

6D



7

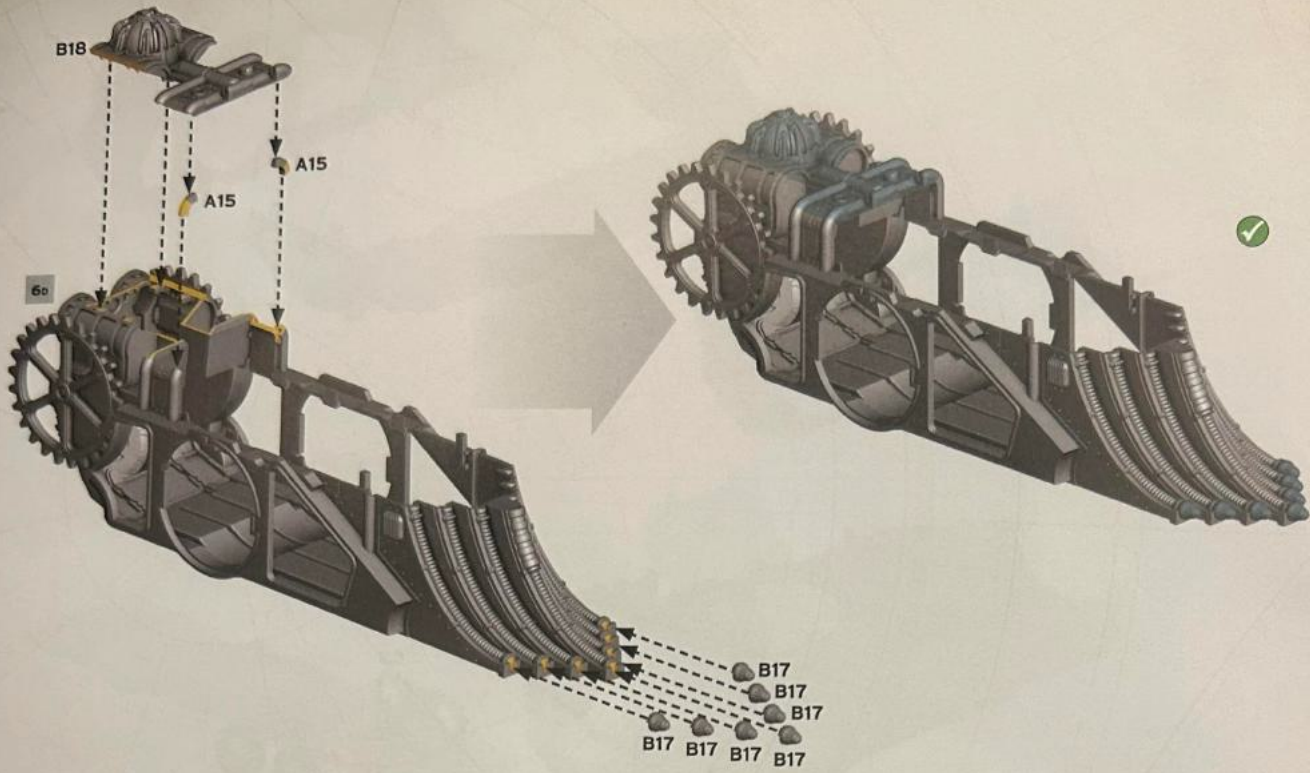

8A

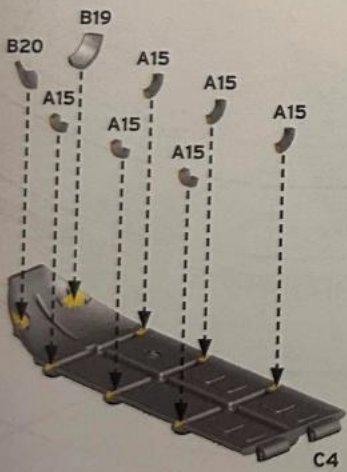

8B

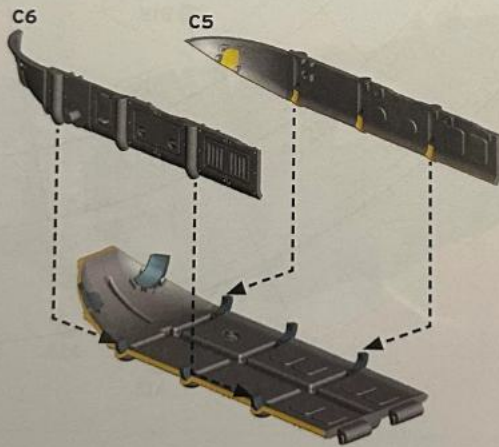

8c



9A

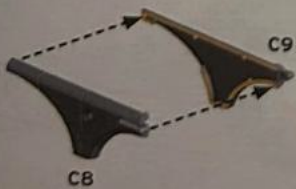

9B



10A

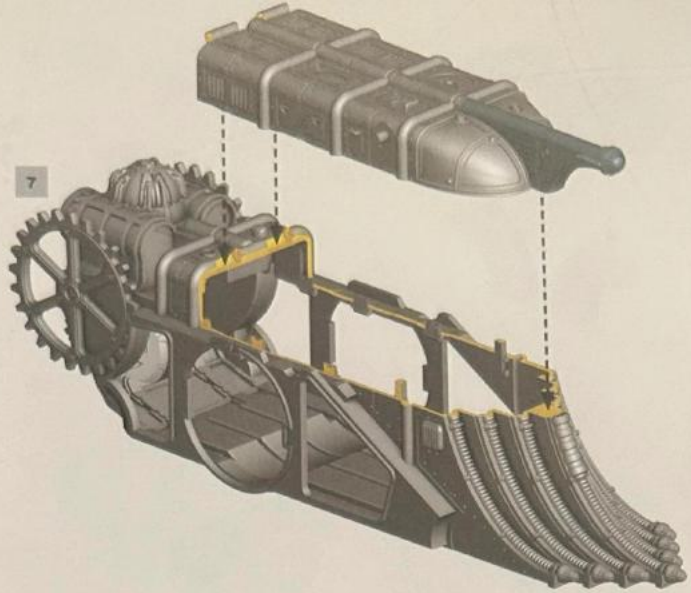

10B

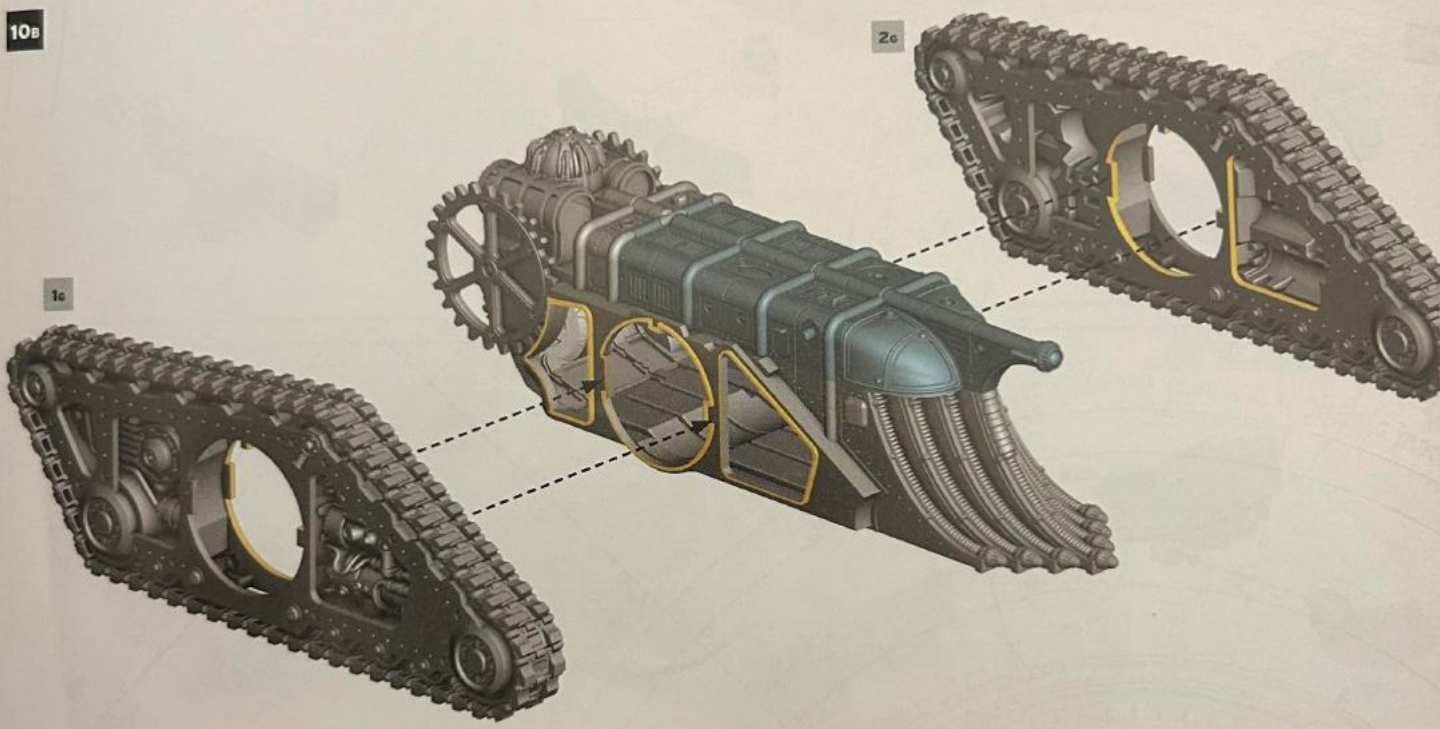

10c

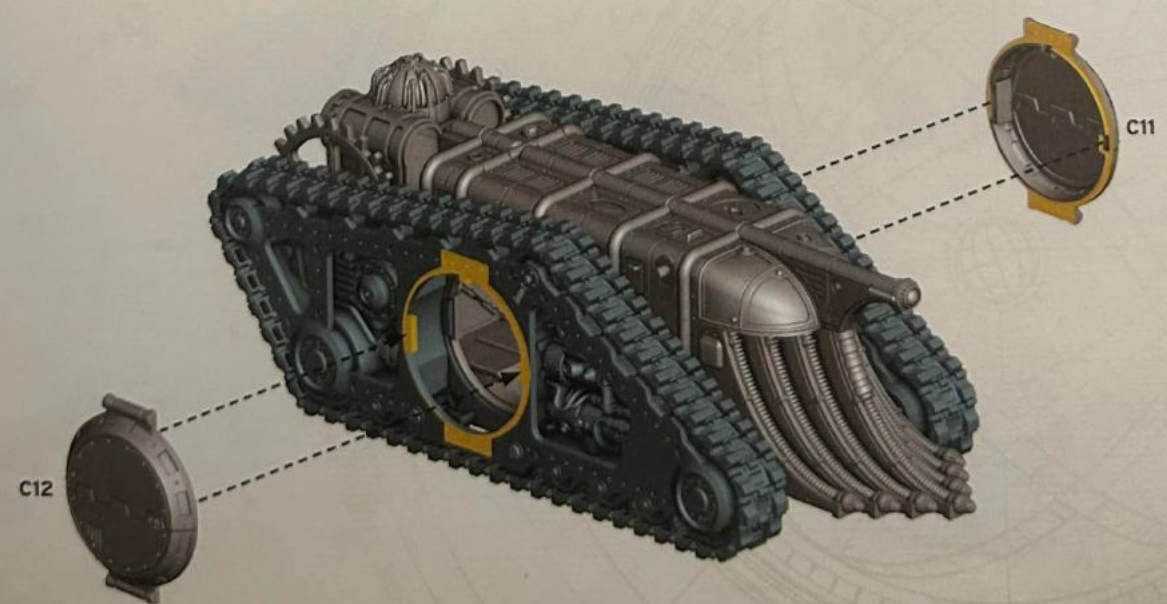

FLARE SHIELD

11a **x2**



11b

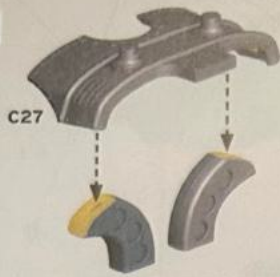

11c



VOLKITE CALIVER

12a



12b



13a

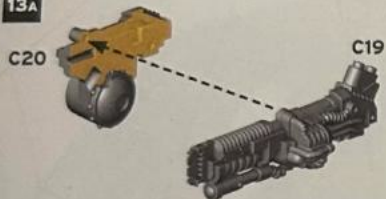

13b

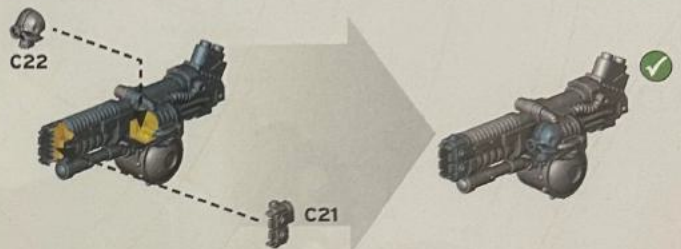

MAULER BOLT CANNON

14a

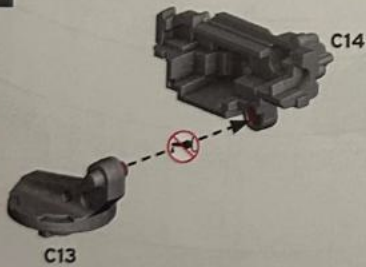

14b

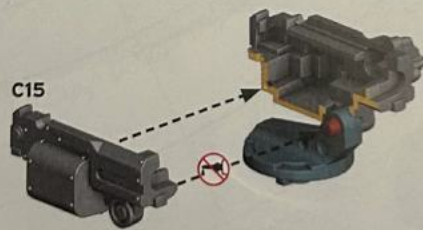

14c



14d



SEARCHLIGHT

15

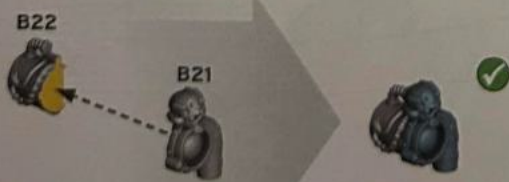

HUNTER-KILLER MISSILE

16



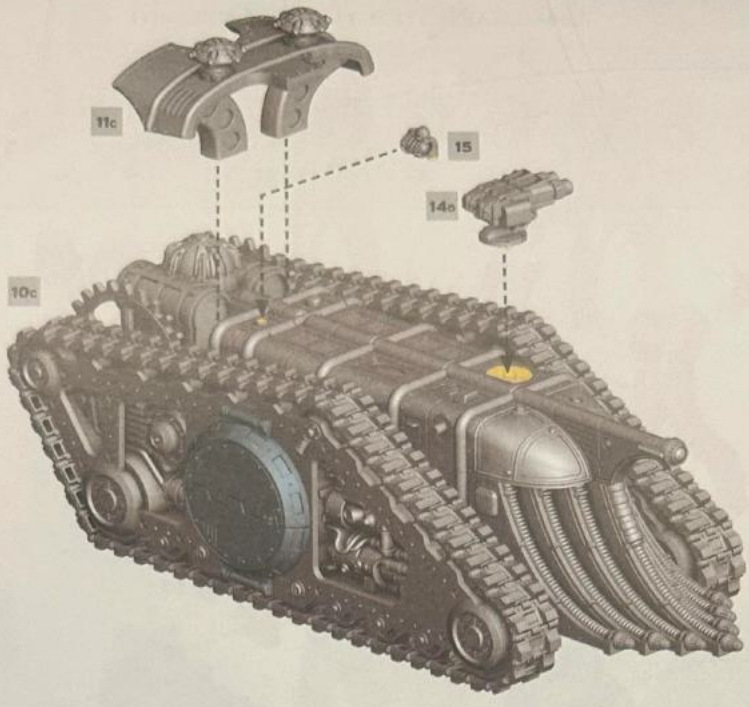

ADSECULARIS TECH-THRALLS COVENANT



TECH-THRALL 1

18A 1, 2, 3

18B 4, 6

18C 5, 7

18D 9, 10

18E 55

19 67, 8, 11, 12

Assembly steps for Tech-Thrall 1:

- 18A:** Attach pieces 1, 2, and 3 to the torso.
- 18B:** Attach pieces 4 and 6 to the chest.
- 18C:** Attach piece 5 to the back and piece 7 to the head.
- 18D:** Attach pieces 9 and 10 to the waist.
- 18E:** Attach piece 55 to the waist.
- 19:** Attach piece 67 to the head, piece 8 to the hand, and piece 11 to the hand. Place the figure on base 12.

TECH-THRALL 2

20A 13, 14

20B 12, 18

20C 15, 17

20D 16

20E 19, 20

20F 55

20G 21, 58, 12

Assembly steps for Tech-Thrall 2:

- 20A:** Attach pieces 13 and 14 to the torso.
- 20B:** Attach pieces 12 and 18 to the chest.
- 20C:** Attach pieces 15 and 17 to the back.
- 20D:** Attach piece 16 to the waist.
- 20E:** Attach pieces 19 and 20 to the waist.
- 20F:** Attach piece 55 to the waist.
- 20G:** Attach piece 21 to the hand, piece 58 to the head, and place the figure on base 12.

TECH-THRALL 3

21A 22, 23

21B 24

21C 25, 28

21D 26, 27

Assembly steps for Tech-Thrall 3:

- 21A:** Attach pieces 22 and 23 to the legs.
- 21B:** Attach piece 24 to the waist.
- 21C:** Attach pieces 25 and 28 to the chest.
- 21D:** Attach pieces 26 and 27 to the back.

21c



21f



21e



TECH-THRALL 4

22a



22b



22c



22d



22e



22f

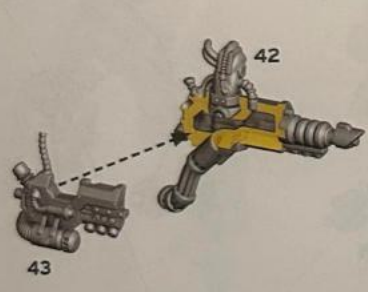

22g

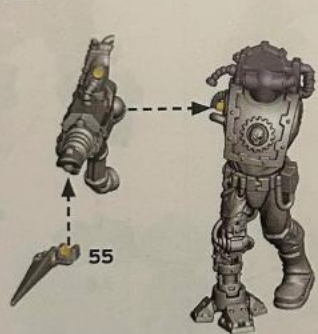

22h



TECH-THRALL 5

23a



23b



23c



23d



23e



23f



THALLAX COHORT



A1

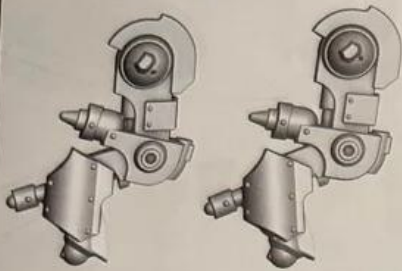

24A-B

25A-B



A7

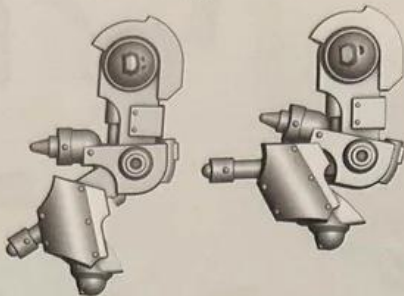

26A-B

27A-B



A10

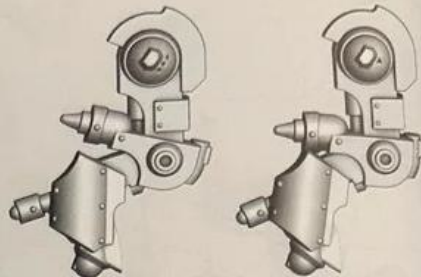

28A-B

29A-B

24A



A4

A5

24c

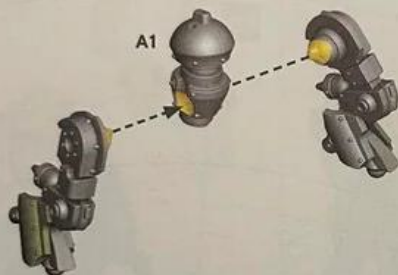

A1

24d

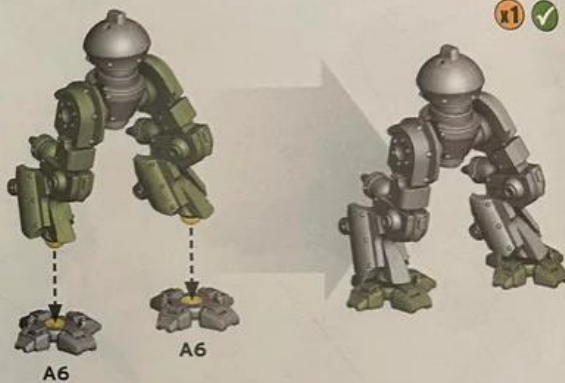

A6

A6

24B



A2

A3

25c

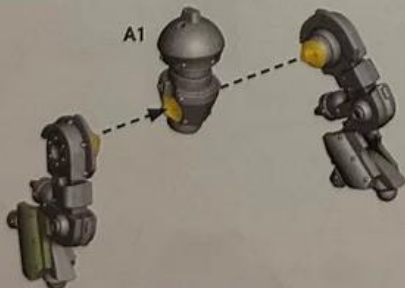

A1

25e



A15

A6

25A

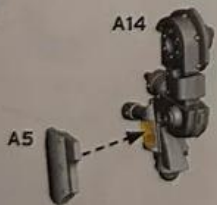

A14

A5

25B



A13

A3

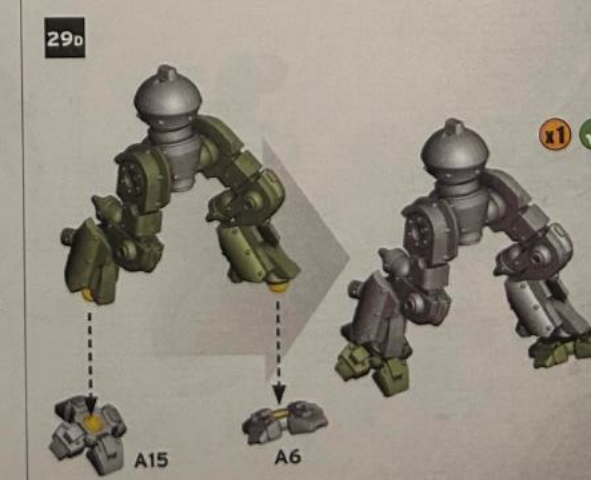
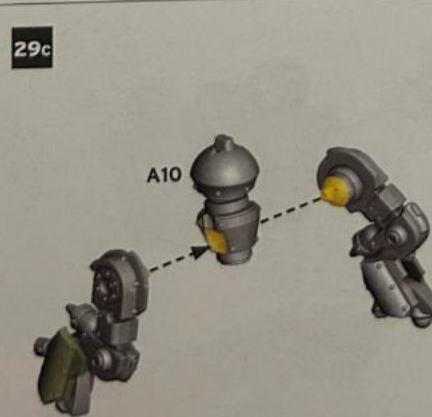
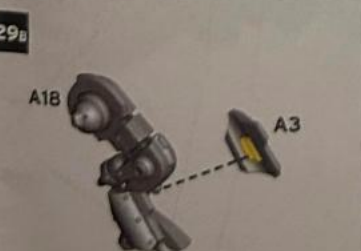
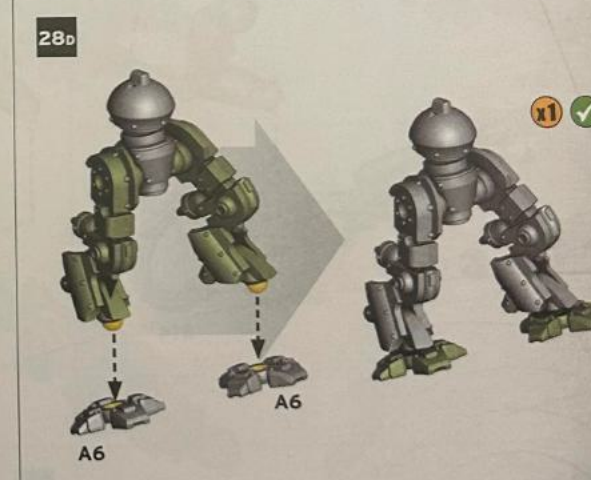
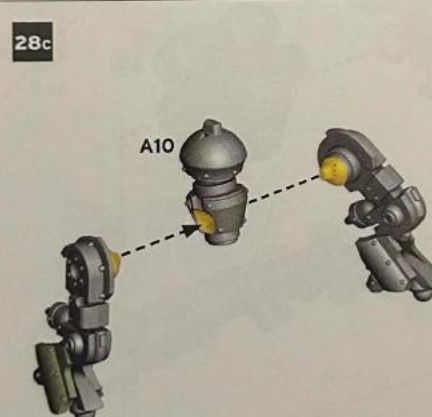
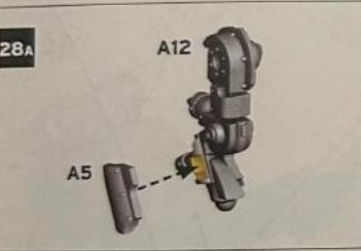
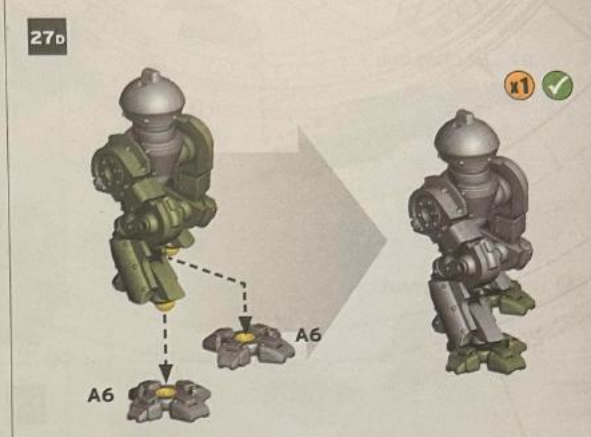
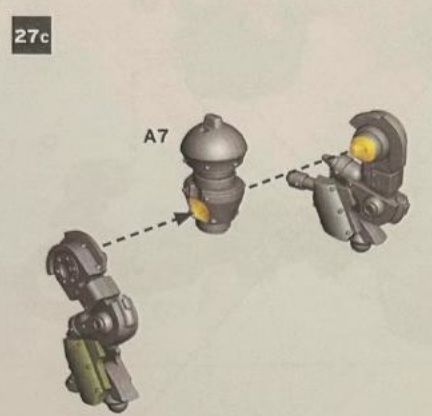
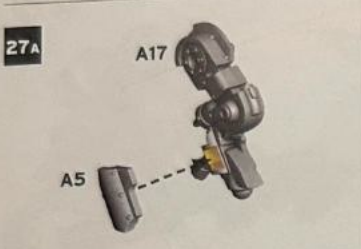
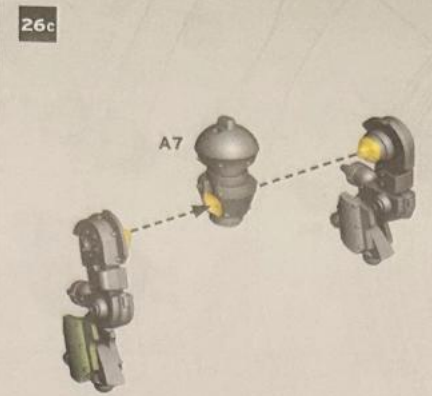
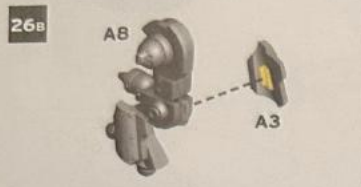
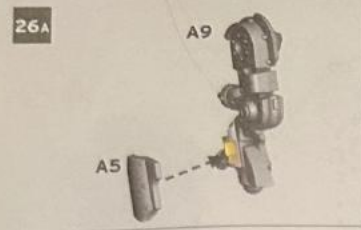

30A



30B



30c

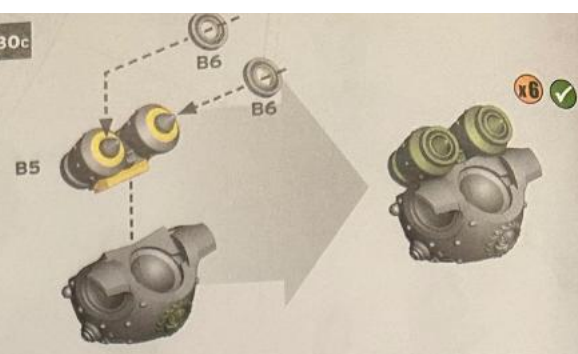

31A



31B

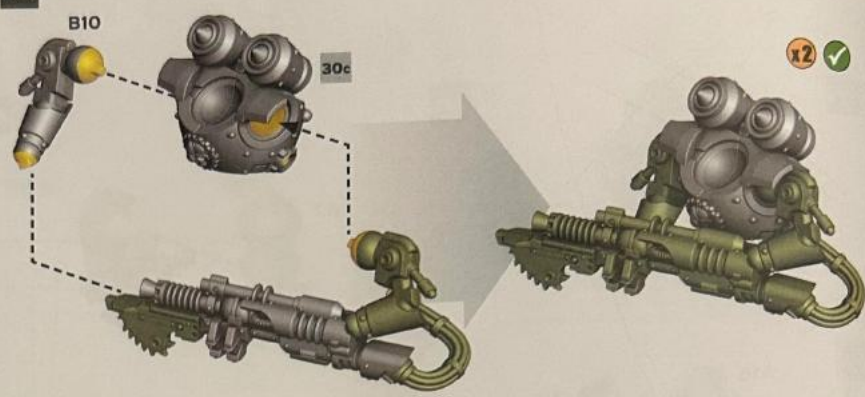

B11. Chain bayonet

32A

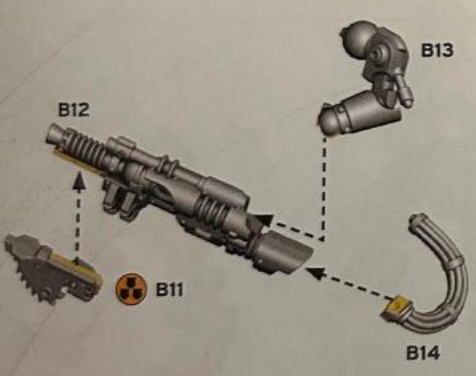

32B

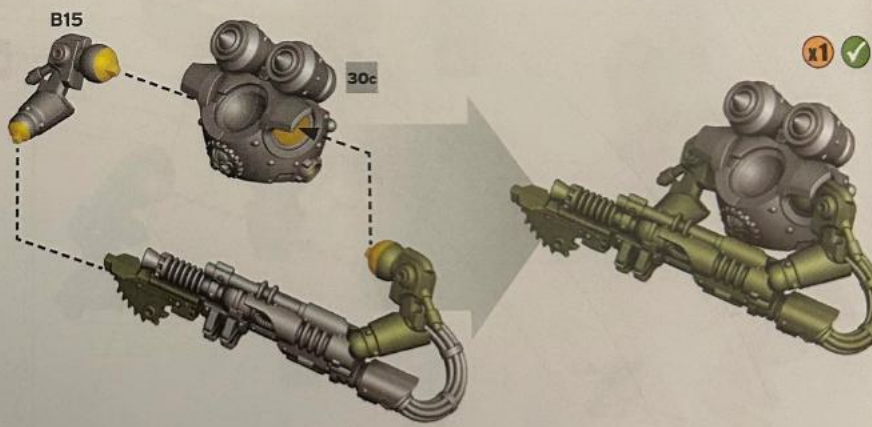

33A

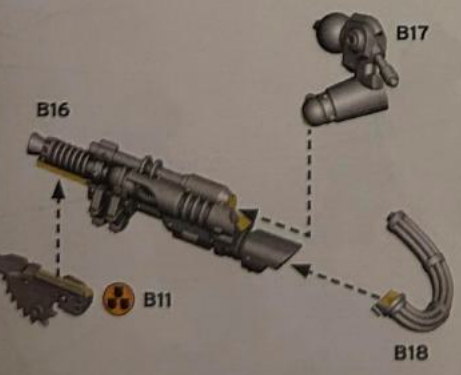

33B

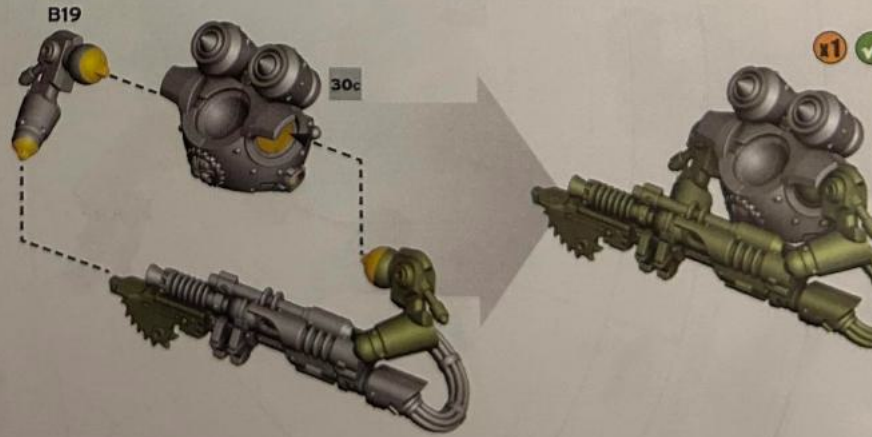

2

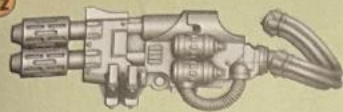

MULTI-MELTA



PHASED PLASMA-FUSIL

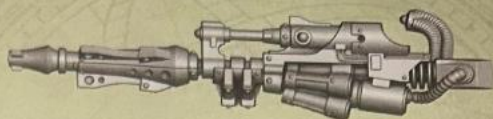

PHOTON THRUSTER

MULTI-MELTA

34A

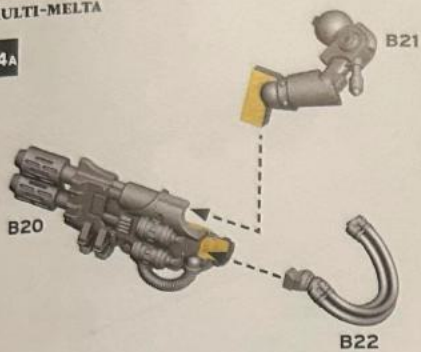

34B

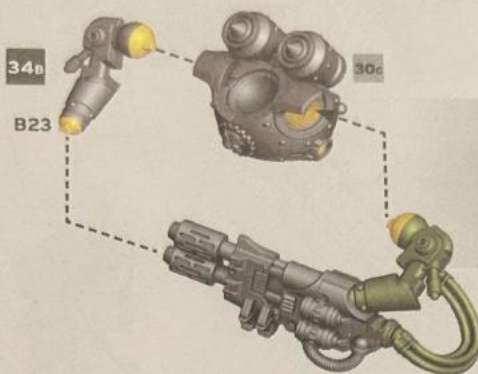

PHASED PLASMA-FUSIL

35A

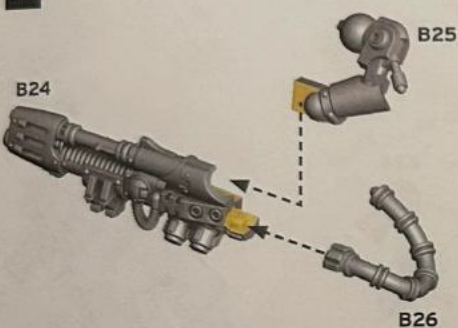

35B

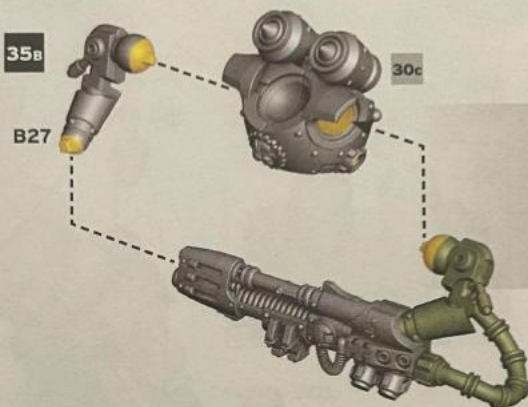

PHOTON THRUSTER

36A

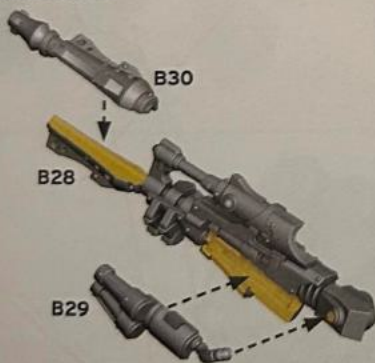

36B



36C

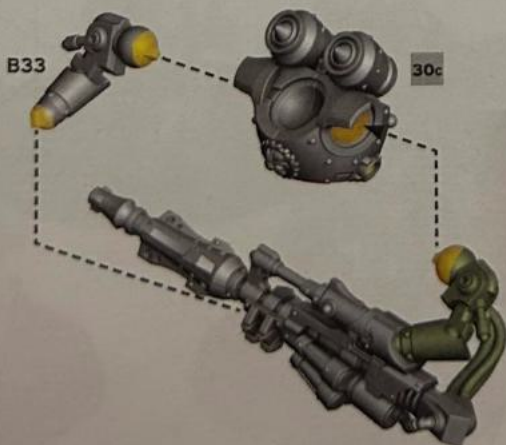

37A

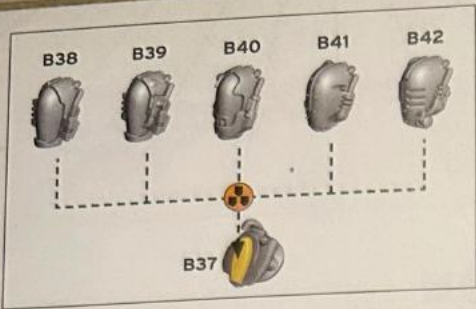

37B

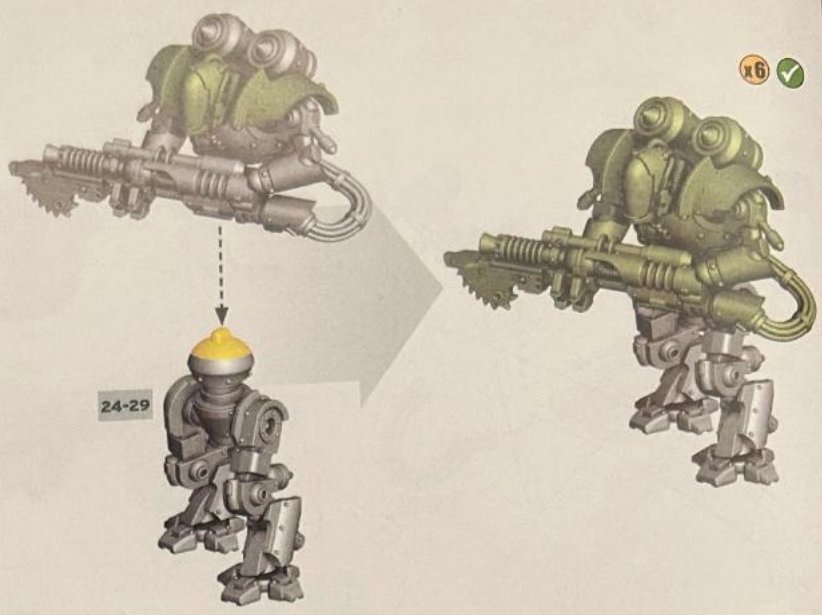

A22 A21



38A

37B



38B

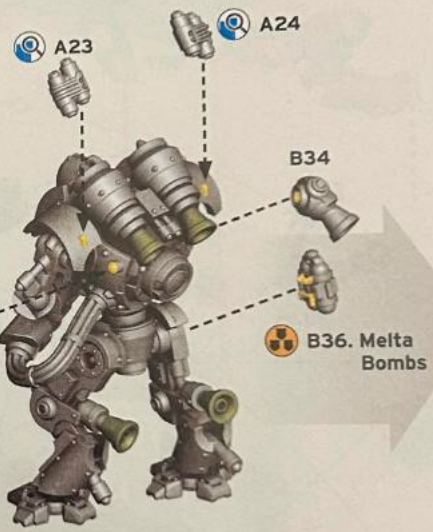
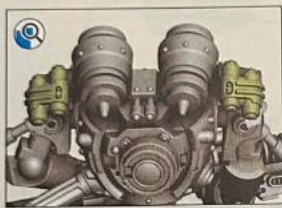

x6 ✓



CASTELLAX BATTLE-AUTOMATA MANIPLE

39A



39B



39c



40A



40B

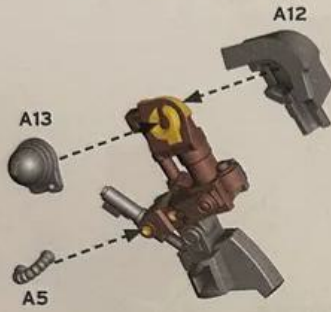

40c

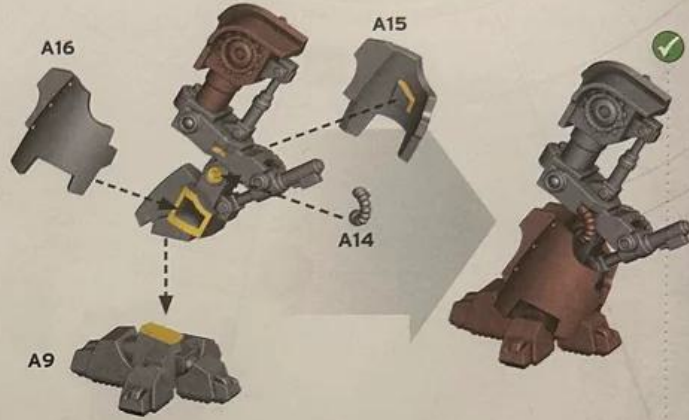

41A



41B

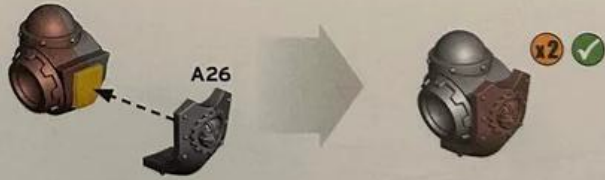

42



43A



43B

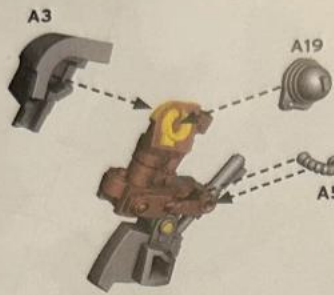

43c

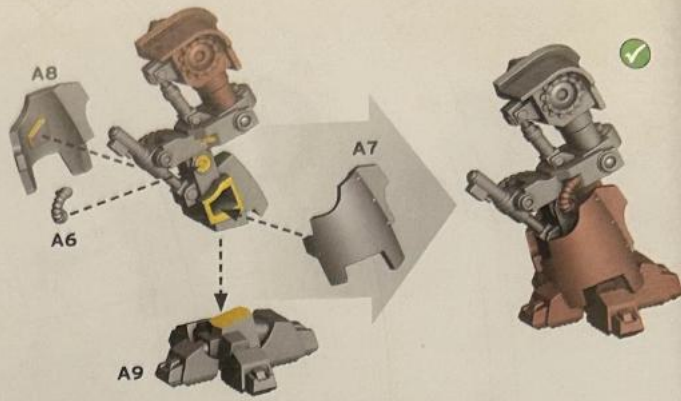

44A



44B

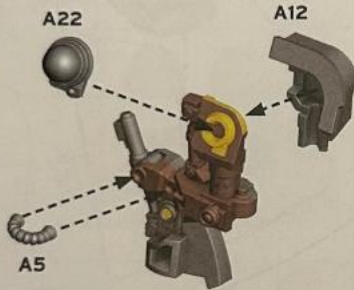

44c

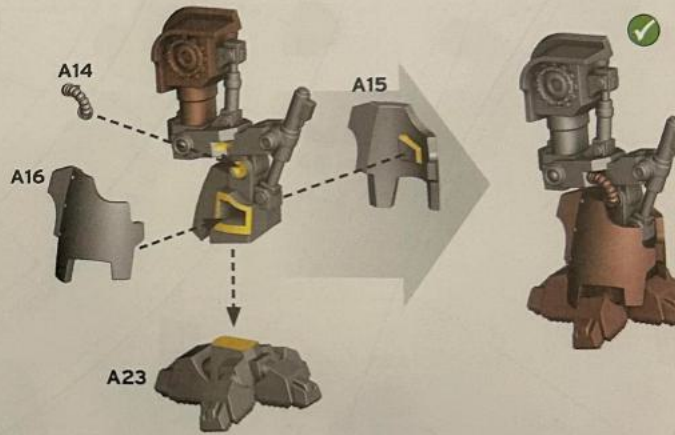

45

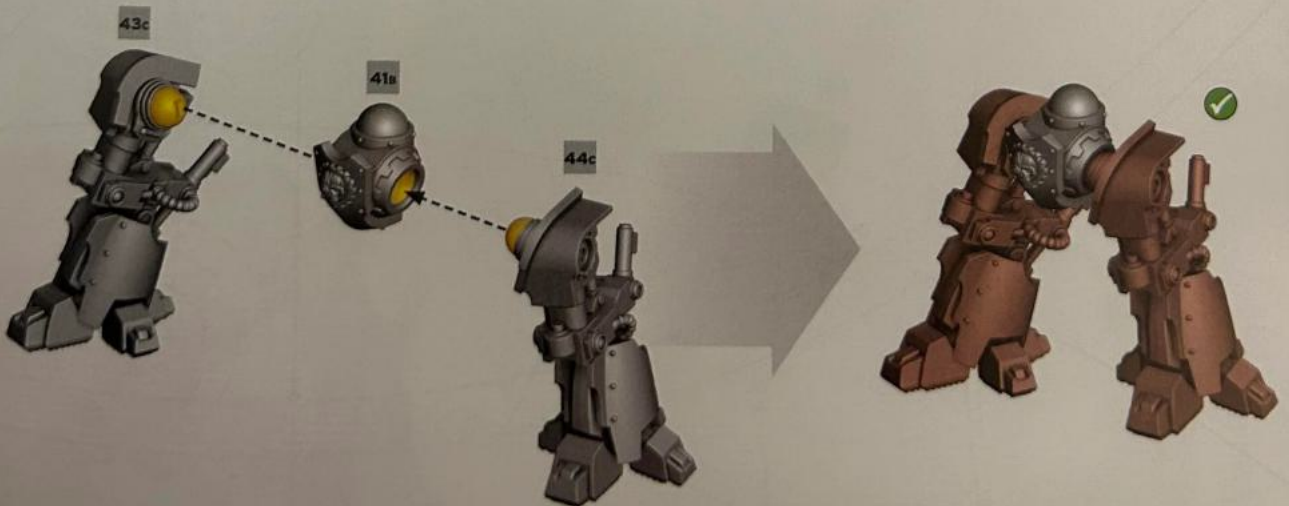

46A



46B

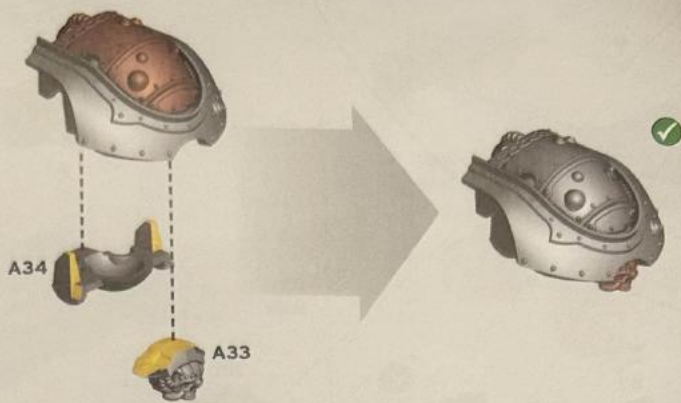

47A

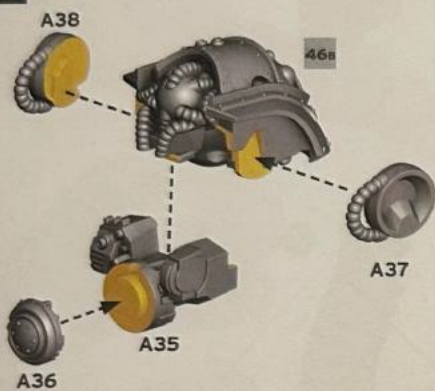

47B

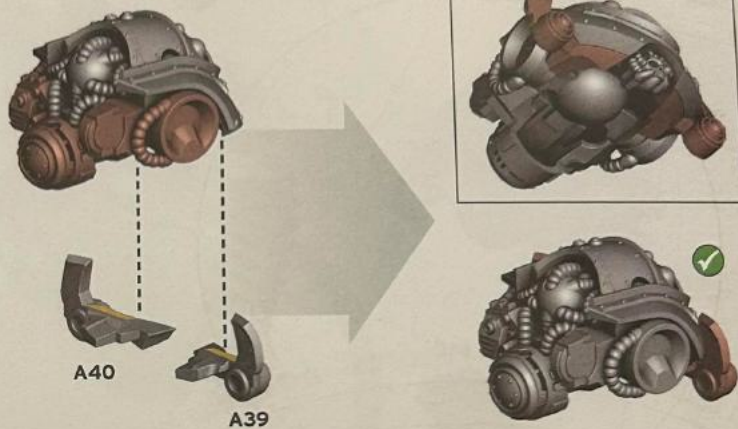

48



49A

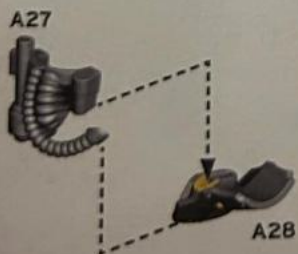

49B



MAULER BOLT CANNON

50A

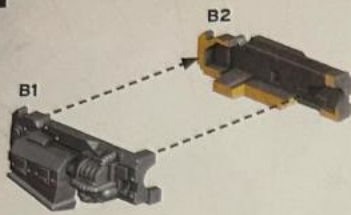

50B

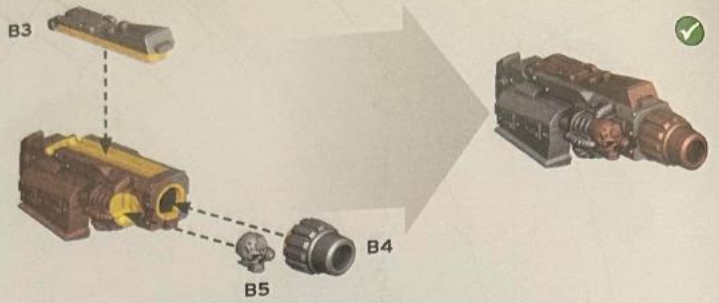

51

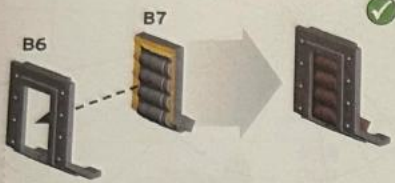

52A

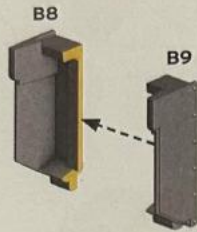

52B

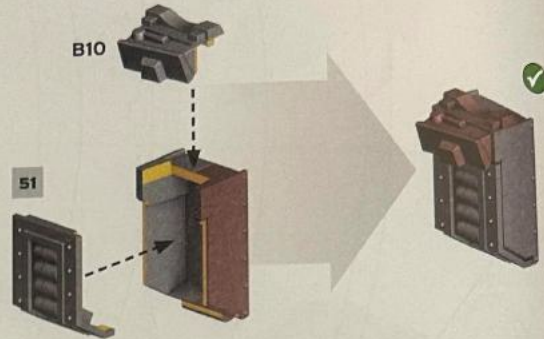

53

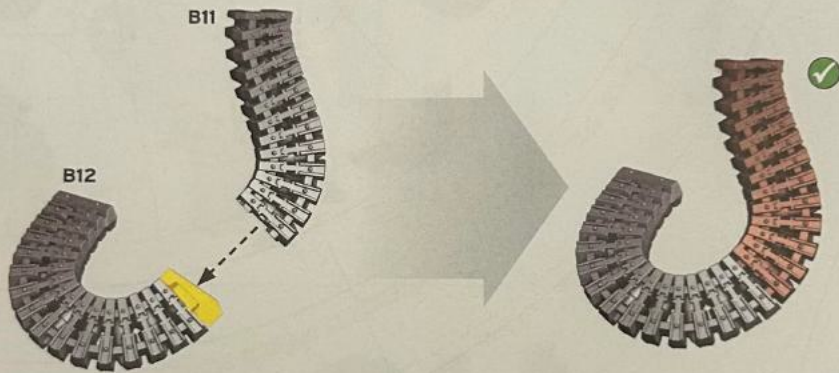

54A



54B

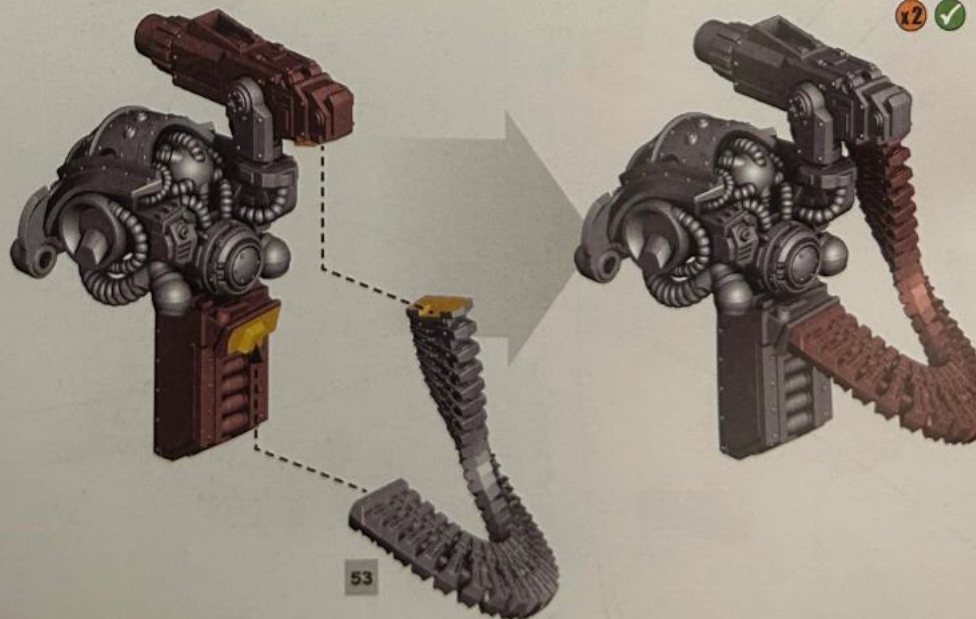



DARKFIRE CANNON



MULTI-MELTA

DARKFIRE CANNON

55

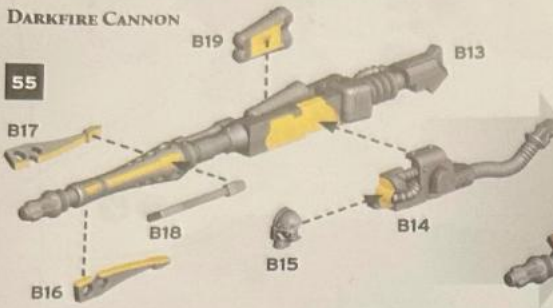

56A

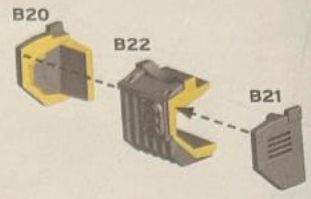

56B



56C

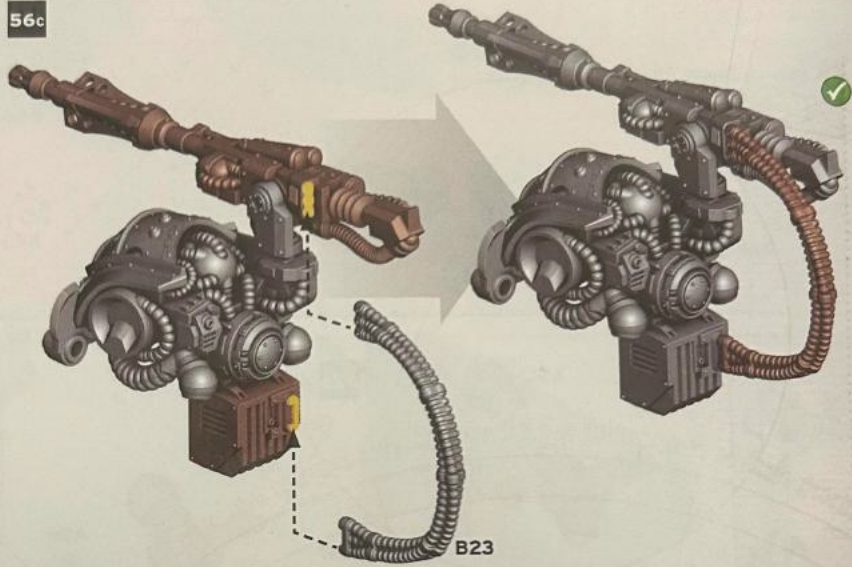

MULTI-MELTA

57



58A

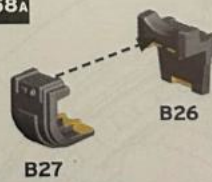

58B



58C



58D

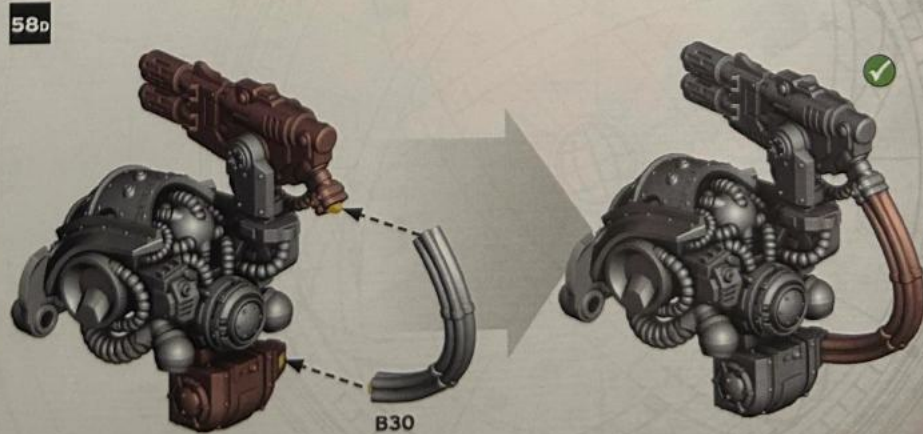

SHOCK CHARGERS

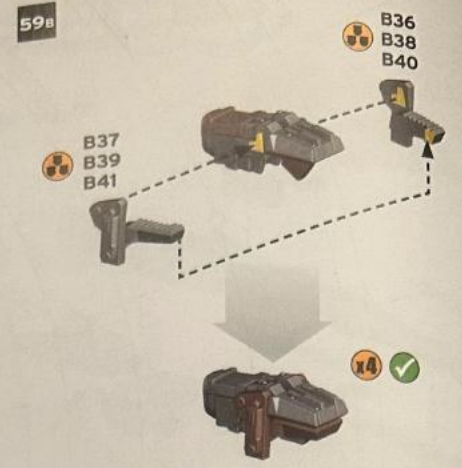
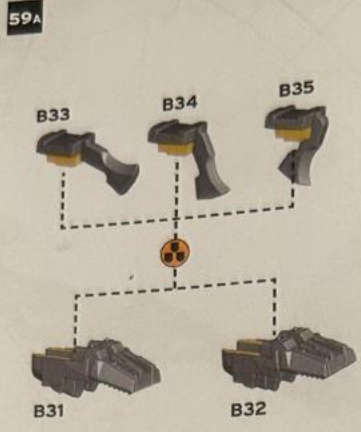

POWER BLADE ARRAY

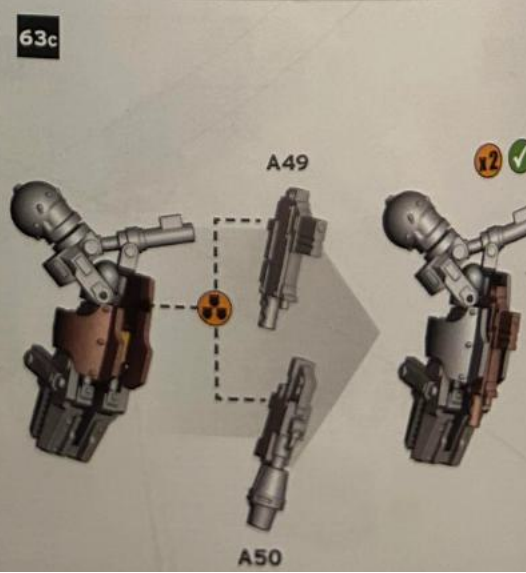
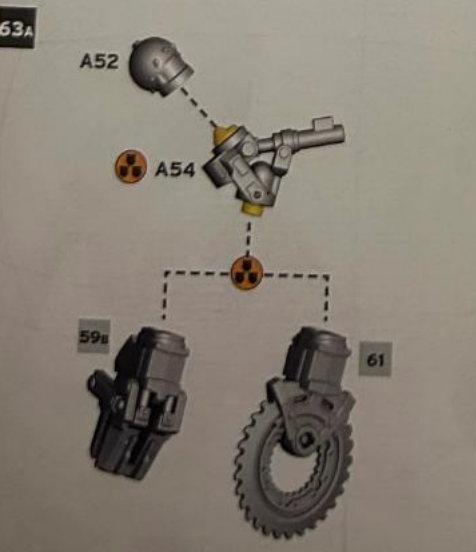
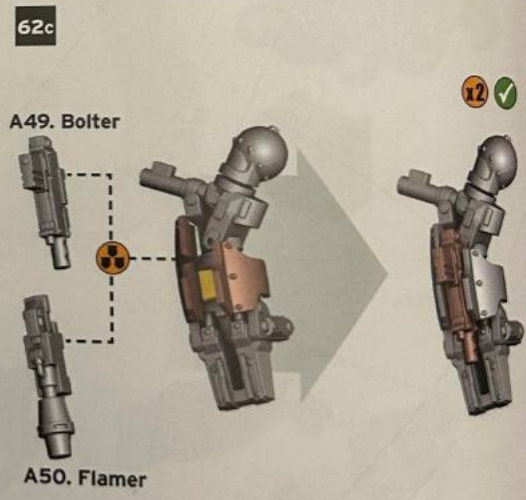
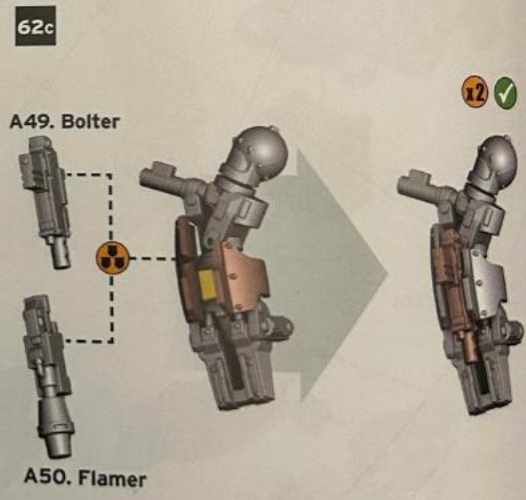
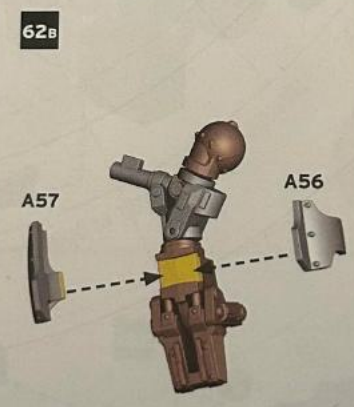
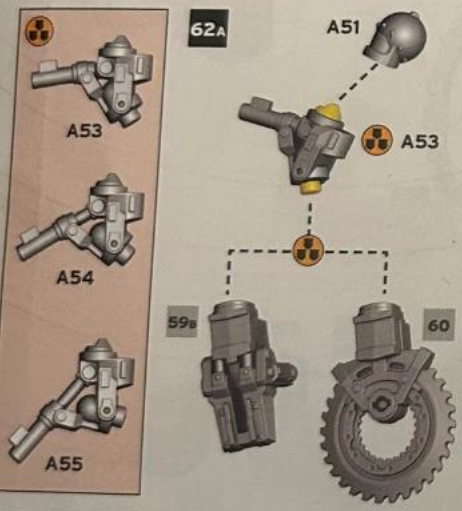
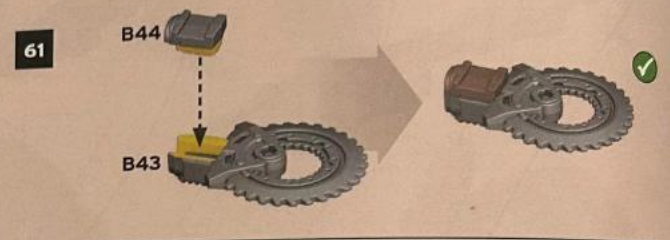

64A

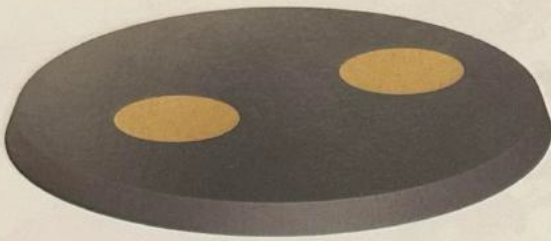
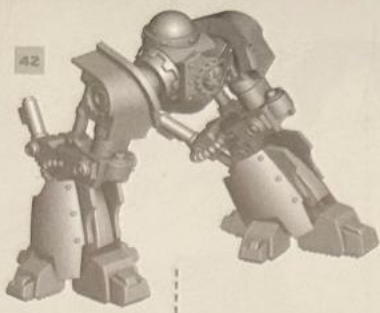

45

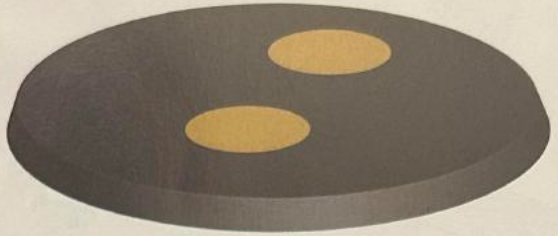

64B

54B

A44

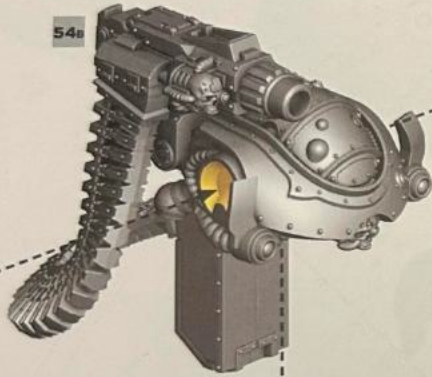

54B

A44

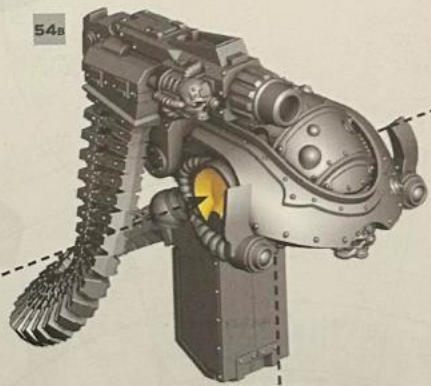

49B



49B



64c

