



Free Downloads of Build Instructions,
Assembly Booklets & How To Guides

BuildInstructions.com

MARS PATTERN WARLORD TITAN

BELICOSA VOLCANO CANNON

The volcano cannon is the most devastating energy weapon produced by the forges of the Mechanicum, short of the continent-razing weapons mounted on the warships of the Imperialis Armada. Volcano cannon are often classified by the chassis that they are mounted on and the potency of the plasma core that powers them. One of the mightiest and most devastating is the Belicosa pattern volcano cannon, a weapon so fearsome that only the plasma reactor of a mighty Warlord Titan can feed its ravenous appetite for energy and make possible the destruction of the most terrible foes of Mankind.

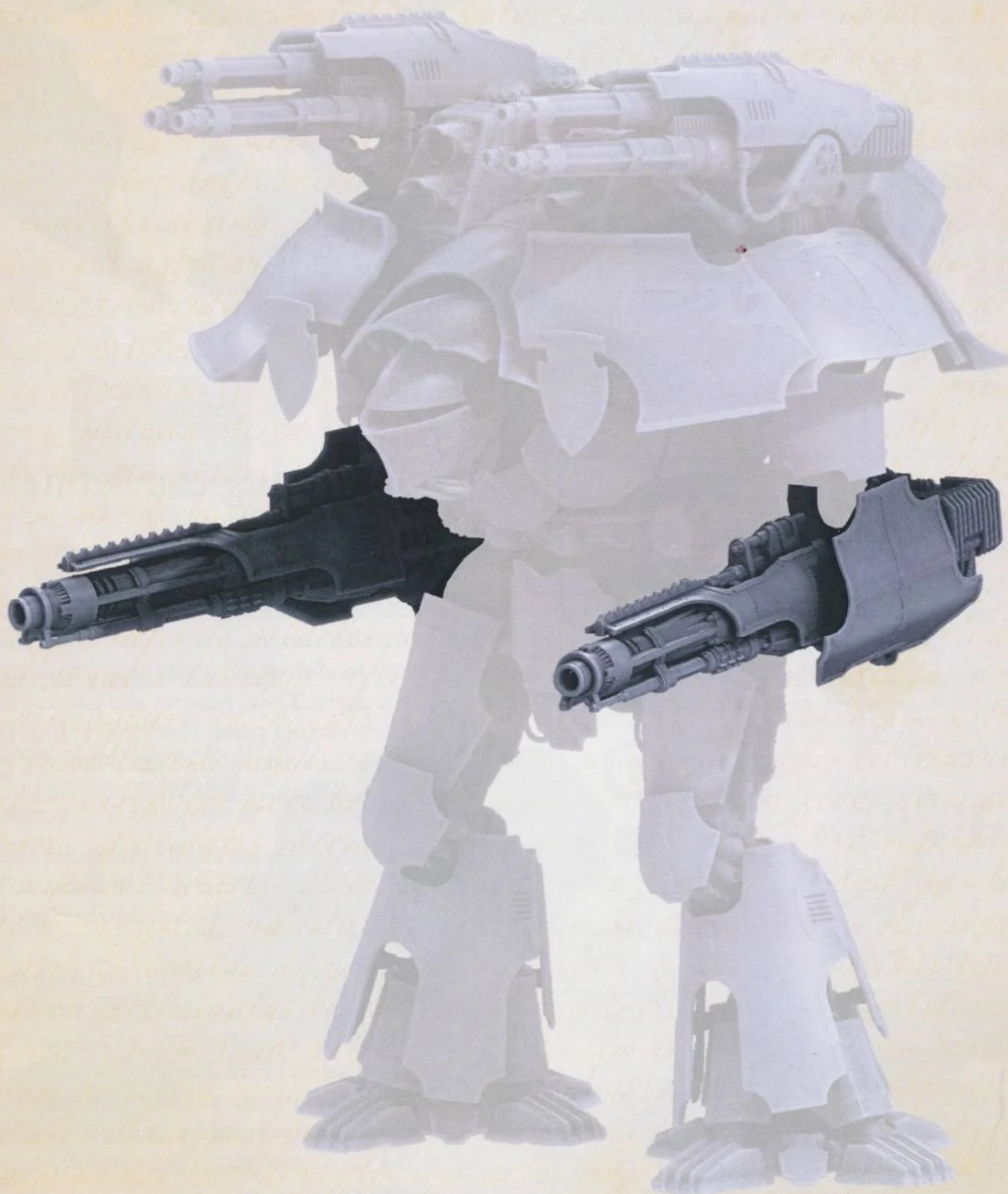

THIS IS NOT A TOY

Not suitable for children under 15 years of age.

WARNING: Resin dust can be harmful if inhaled. Always wear a dust mask or respirator when sanding or sawing resin parts.

www.forgeworld.co.uk

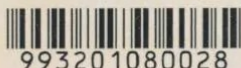

993201080028

Components

Before assembly, check that none of the components are missing.

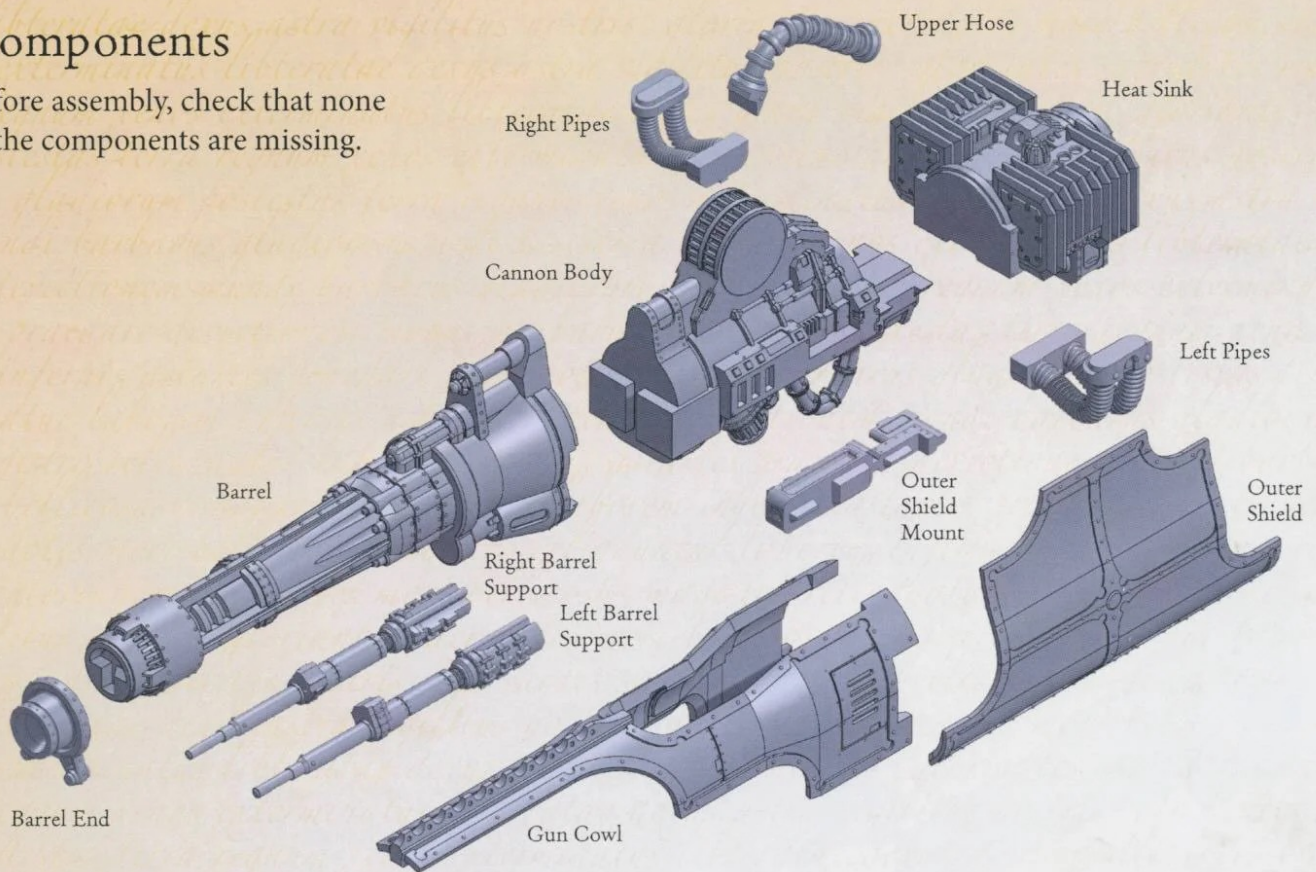

Assembly Legend

Shim to be Removed



Parts for Assembly



Note



Optional Assembly



Glue Contact Area



Preparing the Model for Assembly

Before assembling the model, wash each part thoroughly with an abrasive brush, such as a toothbrush, to remove any model release agent that may still be on the surface of the parts. Then, remove any excess resin such as mould lines, casting gates, vents and shims. For a more detailed guide to working with resin models, go to the Downloads section of the Forge World website.

This kit contains all the pieces required to construct a Mars pattern Warlord Titan Belicosa Volcano Cannon. To glue the resin pieces together, use Citadel Super Glue.

NOTE: We have cast this kit using the most advanced techniques and the best quality resin, but due to the nature of the casting process, your model may contain small air bubbles. These can easily be filled with model filler or super glue. Any slight warpage of thin parts can easily be corrected by immersing the part in hot tap water for about 1 minute, then carefully bending it back into shape.

If you need to contact the Forge World Customer Service team regarding this model, you can get in touch via email - forgeworld@gwplc.com - or call:

0115 900 4995 within the UK

011 44 115 900 4995 from the USA and Canada

0011 44 115 900 4995 from Australia

011 44 115 900 4995 from Europe and the rest of the world.

I

Heat Sink

Cannon Body

Barrel

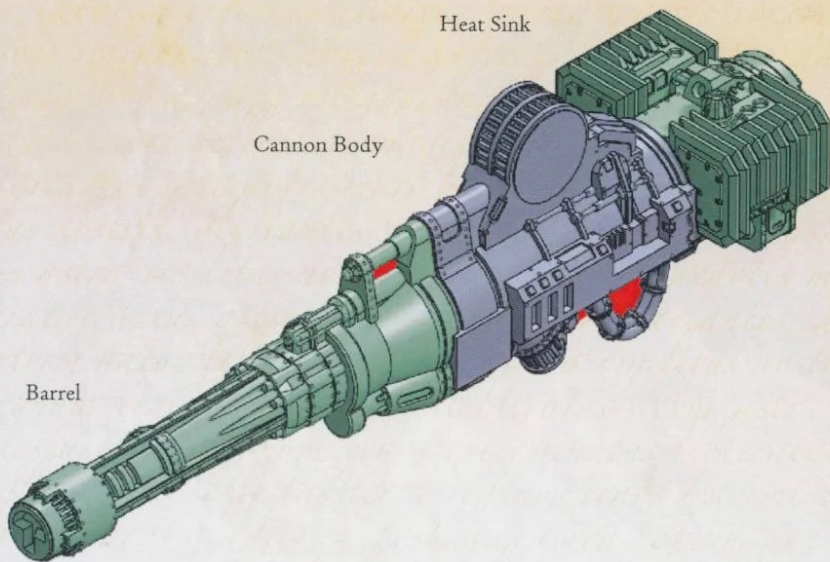

Ia
Use a pair of clippers to remove any vents and casting gates. The Working with Resin guide on the Forge World website goes into more detail about cleaning up resin components.

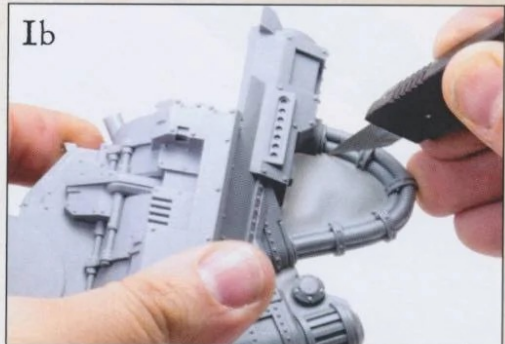

Ib
Remove shims as indicated in red on the construction diagram to the left.

2a

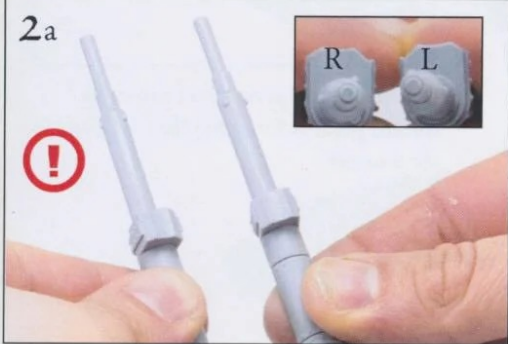

Check to make sure the Left and Right Barrel Supports are properly identified. If in doubt, dry fit them to the model to see if they locate. The image insert shows the orientation of the Barrel Supports when looking from the front.



The Outer Shield Mount (highlighted in blue on this diagram) can be placed on the left or the right side of the Volcano Cannon, depending on which side of the Titan you would like the arm mounted to. In the example shown here, the arm would be mounted on the Warlord Titan's left side.

Upper Hose

Left Pipes

Right Barrel Support

Outer Shield Mount

Left Barrel Support

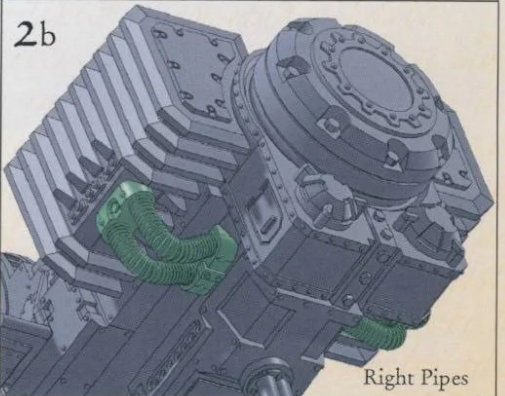
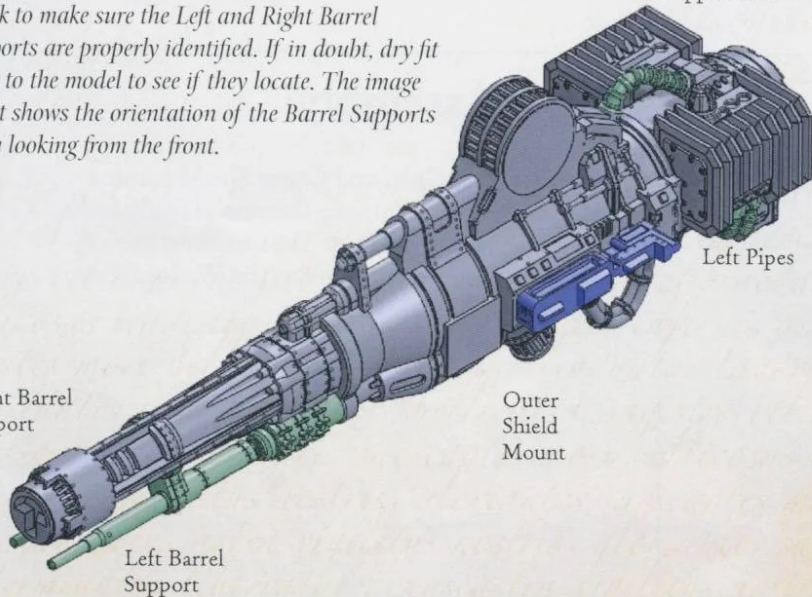

2b

Right Pipes



The Left and Right Pipes are mounted as shown above. To aid with identification, the pipe to the rear of each piece is slightly longer.

2

3a

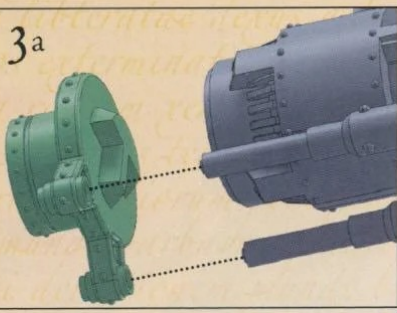

The Barrel End locates as shown.

Barrel End

3

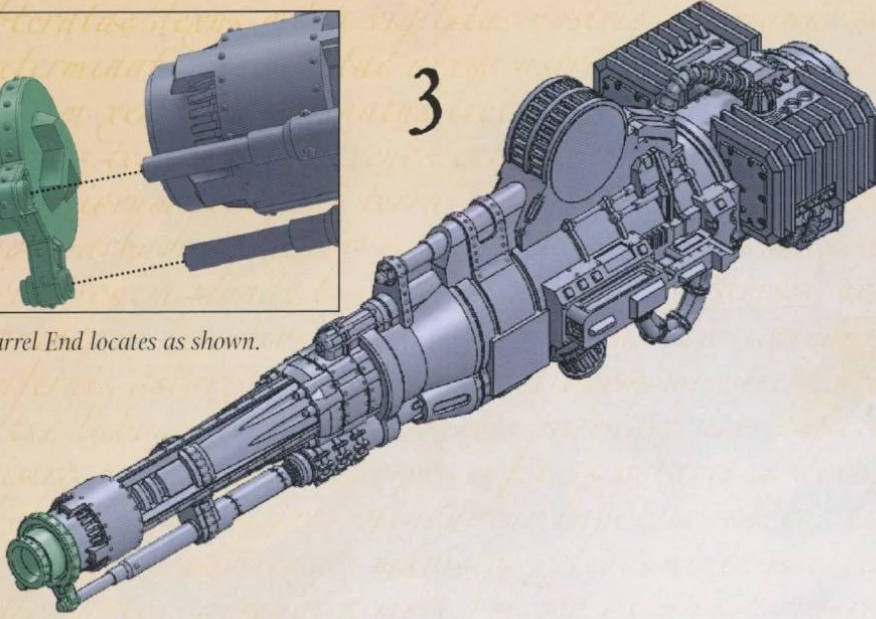

Painting

It is a good idea to paint the model at this stage as attaching the Gun Cowl and Outer Shield will obscure areas of the Volcano Cannon, making the application of paint to those areas considerably more difficult.

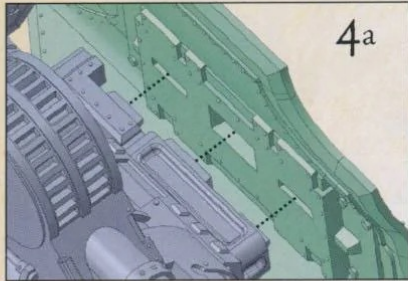

4a

The Outer Shield attaches to the mount as shown above.

Gun Cowl

4

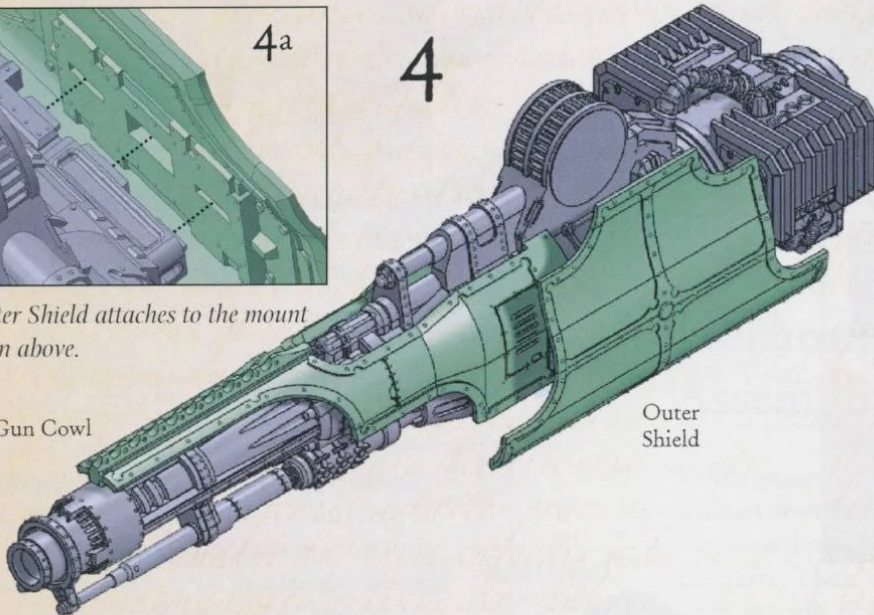

Outer Shield

4b

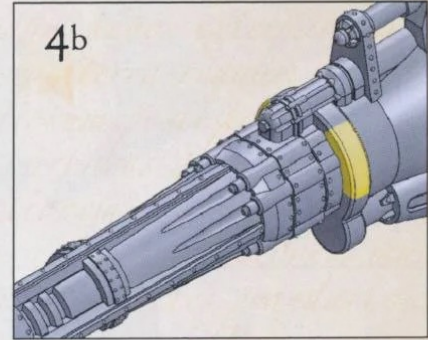

The highlighted area shows where the contact point is for gluing the Gun Cowl to the weapon.

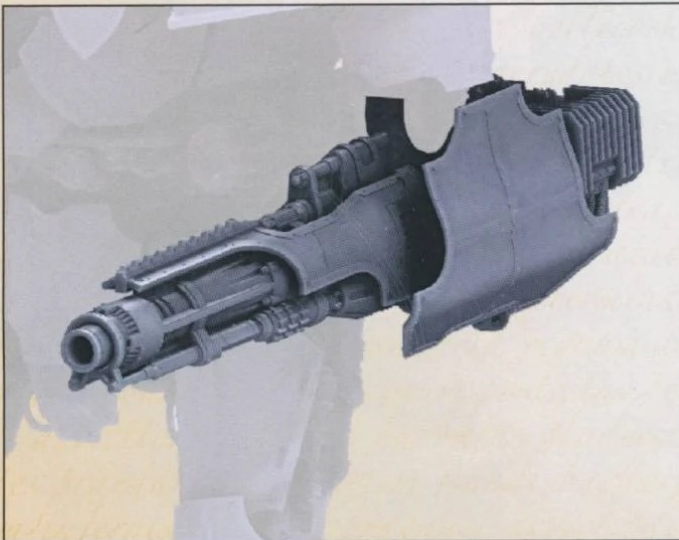

Final Assembly

With the Gun Cowl and Outer Shield painted and attached, the Volcano Cannon is ready to be mounted on to the Titan. The image on the left shows how the weapon fits to the Warlord Titan's arm.