



Free Downloads of Build Instructions,
Assembly Booklets & How To Guides

BuildInstructions.com

WARHAMMER 40,000

BATTLEZONE: MANUFACORUM

MUNITORIUM ARMoured CONTAINERS

ZONE DE BATAILLE: MANUFACORUM // CONTENEURS BLINDÉS DU MUNITORIUM | ZONA DE BATALLA: MANUFACORUM // CONTENEDORES BLINDADOS MUNITORIUM

BATTLEZONE: MANUFACORUM // GEPANZERTE MUNITORIUM-CONTAINER | ZONA DI BATTAGLIA: MANUFACORUM // CONTAINER CORAZZATI DEL MUNITORIUM

戦闘領域: 聖工場 // 兵務局装甲コンテナ | 战区: 铸造厂 // 指挥所装甲集装箱



READ THIS FIRST | À LIRE EN PRIORITÉ | BITTE BEACHT E | LEE ESTO PRIMERO | LEGGI PRIMA QUESTO | 最初にお読みください。| 请优先阅读

ENG BEFORE ASSEMBLING YOUR MINIATURES, PLEASE READ THROUGH THE INSTRUCTIONS IN THIS BOOKLET CAREFULLY. A pair of plastic cutters is required to remove the plastic components in this kit from their frame. We advise using a mouldline scraping tool to clean up the parts. To assemble your model you will need plastic glue. Games Workshop sells Citadel Fine Detail Cutters, Citadel Mouldline Remover and Citadel Plastic Glue, but does not recommend these products for use by children under the age of 16 without adult supervision.

FRE AVANT D'ASSEMBLER VOS FIGURINES, VEUILLEZ LIRE ATTENTIVEMENT LES INSTRUCTIONS DE CE LIVRET. Une pince coupante est requise pour détacher chaque élément de sa grappe. Nous vous recommandons l'utilisation d'un grattoir pour ébarber les éléments. Pour l'assemblage, vous aurez également besoin de colle plastique. Games Workshop commercialise les Pinces de Précision Citadel, l'Ébarboir Citadel et la Colle Plastique Citadel, mais n'en recommande pas l'utilisation pour des enfants de moins de 16 ans sans la supervision d'un adulte.

ESP POR FAVOR, LEE CUIDADOSAMENTE ESTE LIBRETO DE INSTRUCCIONES ANTES DE EMPEZAR A MONTAR LAS MINIATURAS. Te harán falta unas tenazas para plástico a fin de separar las piezas de la matriz. También aconsejamos una herramienta para rebabas a fin de limpiar cada pieza. Para montar la miniatura necesitarás pegamento para plástico. Games Workshop vende Tenazas Citadel, Herramientas para rebabas Citadel y Pegamento para plástico Citadel, pero no recomienda estos productos a menores de 16 años sin la supervisión de un adulto.

GER VOR DEM ZUSAMMENBAU DER MINIATUREN BITTE DIE ANWEISUNGEN IN DIESER ANLEITUNG AUFMERKSAM DURCHLESEN. Du benötigst einen

Kunststoffseitenschneider, um die Kunststoffbauteile aus dem Gussrahmen herauszutrennen, und Kunststoffkleber, um die Miniatur zusammenzubauen. Außerdem empfehlen wir, die Bauteile vorher mit einem Gussgratenferner zu säubern. Games Workshop bietet Präzisions-Kunststoffseitenschneider von Citadel sowie Citadel-Kunststoffkleber an, empfiehlt aber, dass Kinder unter 16 Jahren diese nur unter Aufsicht eines Erwachsenen benutzen.

ITA PRIMA DI ASSEMBLARE LE TUE MINIATURE LEGGI ATTENTAMENTE TUTTE LE ISTRUZIONI DI QUESTO LIBRETTO. Sono necessarie un paio di tronchesine per plastica per staccare i componenti dai loro sprue. Consigliamo di usare un attrezzo apposito per pulire i componenti. Per assemblare il modello avrai bisogno di colla per plastica. Games Workshop vende Tronchesine di precisione Citadel, Attrezzo per ripulire Citadel e Colla per plastica Citadel, ma non consiglia questi prodotti ad un pubblico minore di 16 anni senza la supervisione di un adulto.

日本語 本キット内のフレームからプラスチックパーツを切り離すためには、ニッパーが必要です。パーツのモールドを平らにするには、専用ツールを使用をお勧めいたします。本キットの組み立てには、プラ用接着剤が必要です。ゲームワークショップはシタデル・ニッパー、プラ用接着剤、シタデル・モールドラインリムーバーを販売しておりますが、16歳以下の子供が大人の監督なしにこれらの道具を使用されることをお勧めしません。

中文 你需要一把模型剪将塑料部件从版件上剪下来。我们建议使用分模线刮刀来处理零件。组装时你还需要用到模型胶水。你可以从 Games Workshop 处购买到 Citadel Fine Detail Cutter 模型剪、Citadel Mouldline Remover 分模线刮刀和 Citadel Plastic Glue 模型胶。但 16 岁以下儿童不得在没有成年人监护的情况下使用这些产品。

- x2**
- Repeat process
 - Répéter l'étape
 - Repetir pasos
 - Vorgang wiederholen
 - Ripeti il processo
 - 同じ作業を繰り返すこと
 - 重复步骤

- 
- Variant assembly
 - Variante d'assemblage
 - Variante de montaje
 - Bauvariante
 - Assemblaggio alternativo
 - 組み立てバリエーション
 - 多种组装方式

- 
- Do not glue the components
 - Ne pas coller les éléments
 - No pegar los componentes
 - Bitte die Teile nicht kleben
 - Non incollare i componenti
 - このパーツは接着不可
 - 请勿粘接

- 
- Stage complete
 - Étape terminée
 - Paso completado
 - Schritt abgeschlossen
 - Fase completa
 - このステージの完成
 - 完成

1 a **x3**

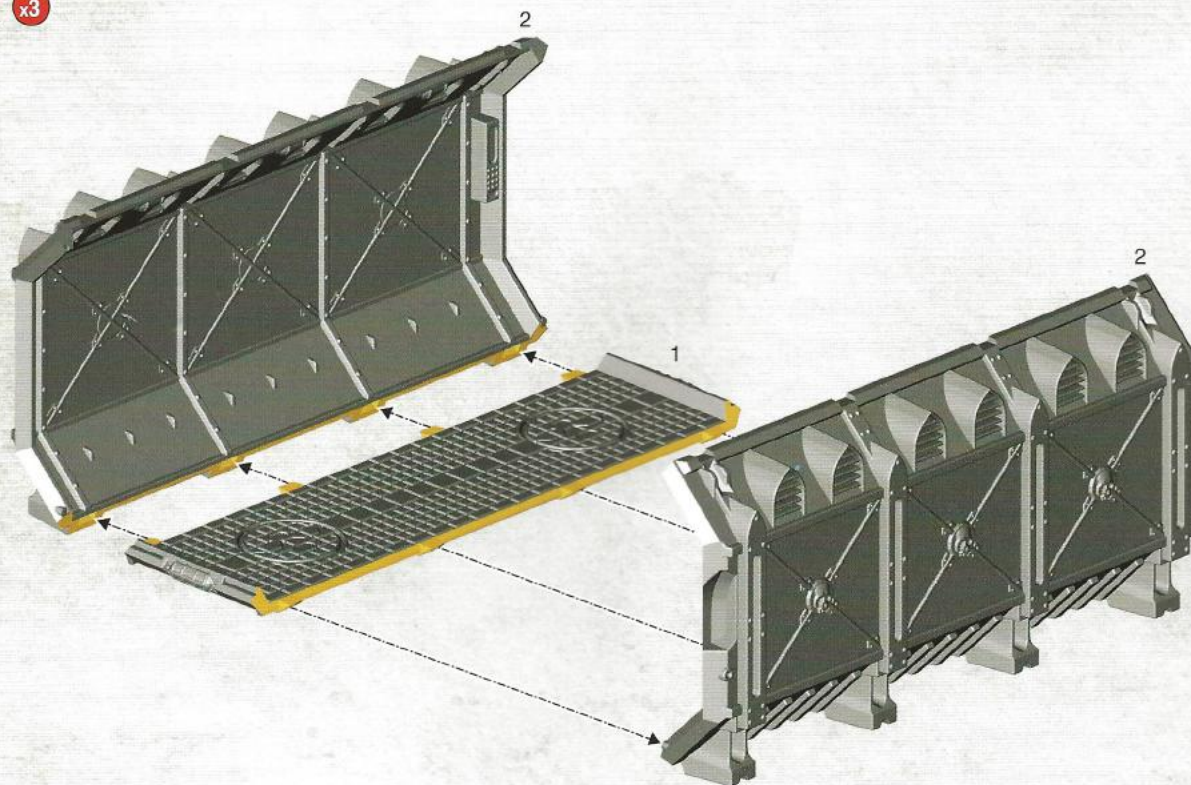

1 b **x3**

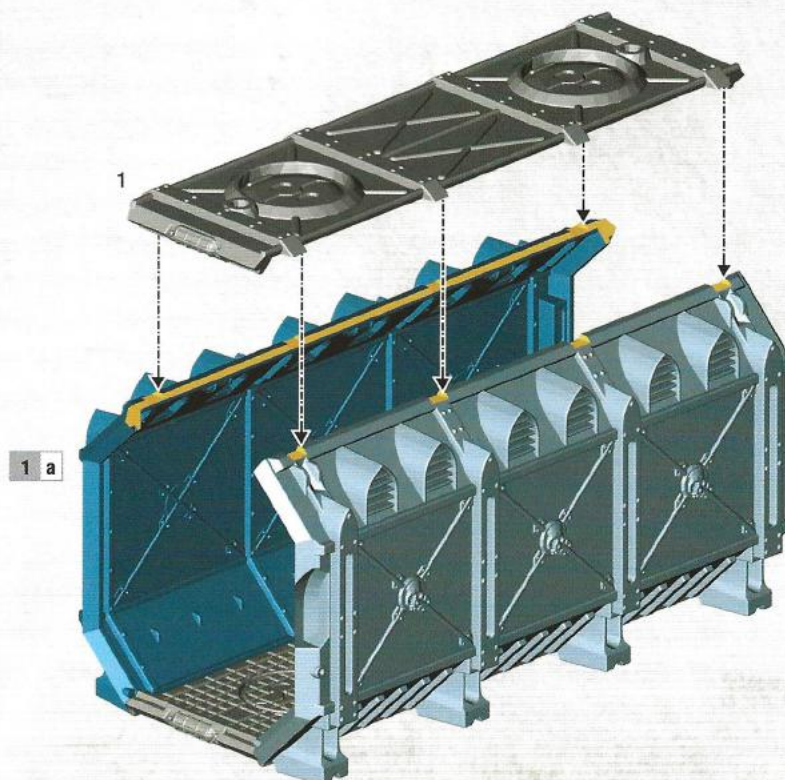

1 c x3

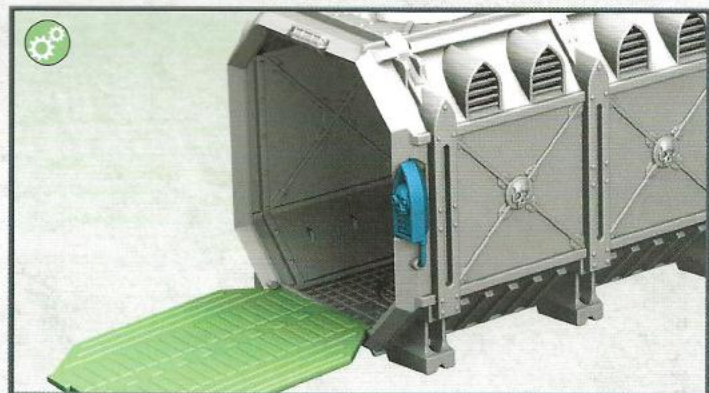
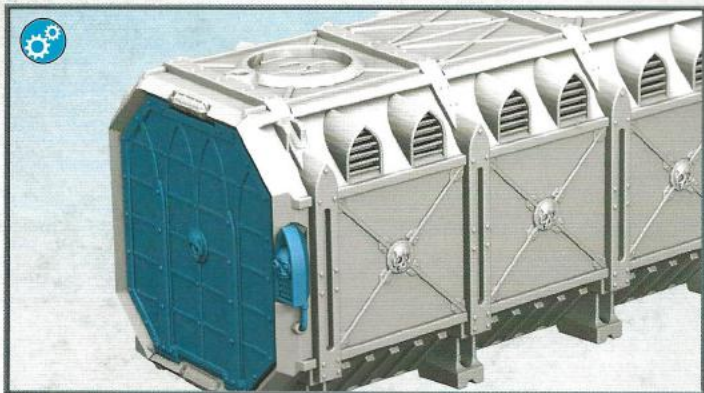
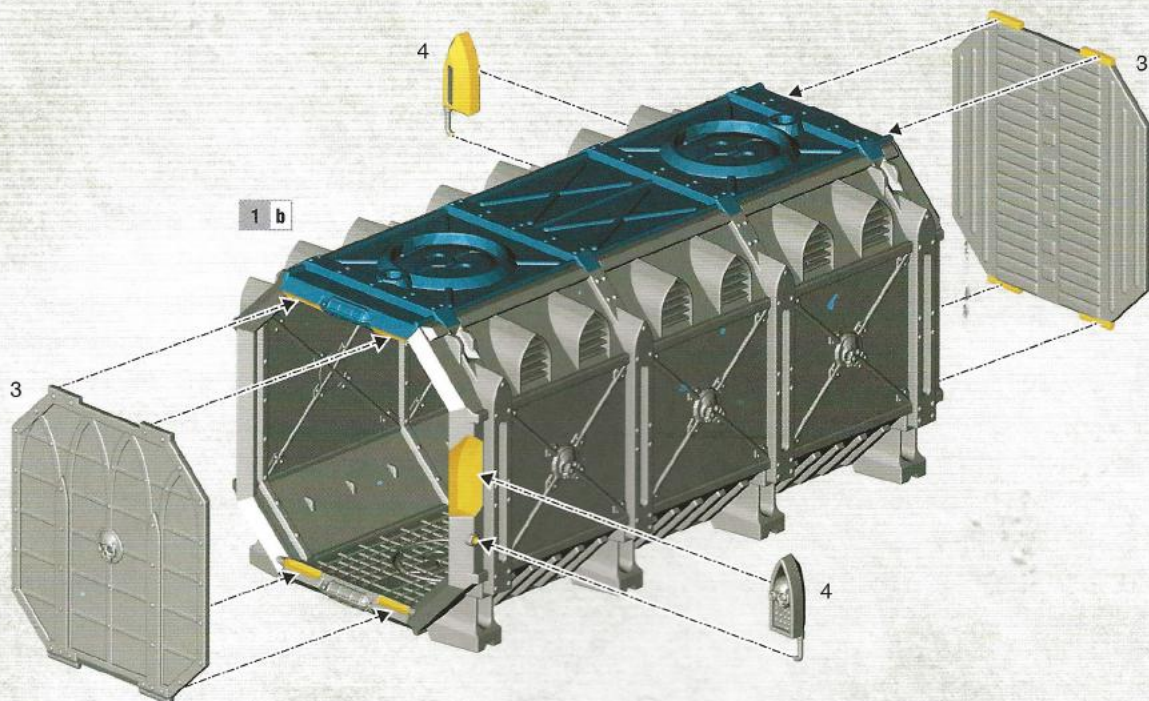

1 d x3

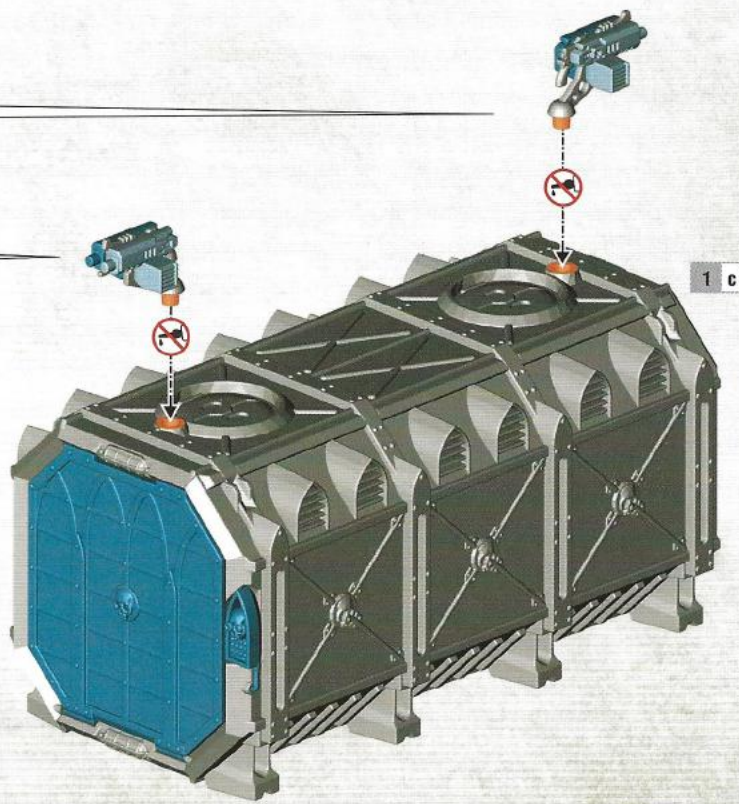
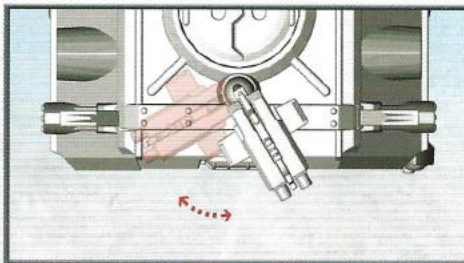
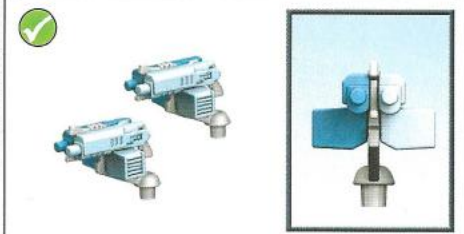
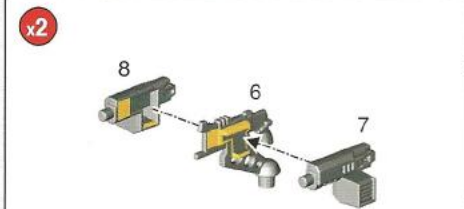

1 e x3

5

1 d

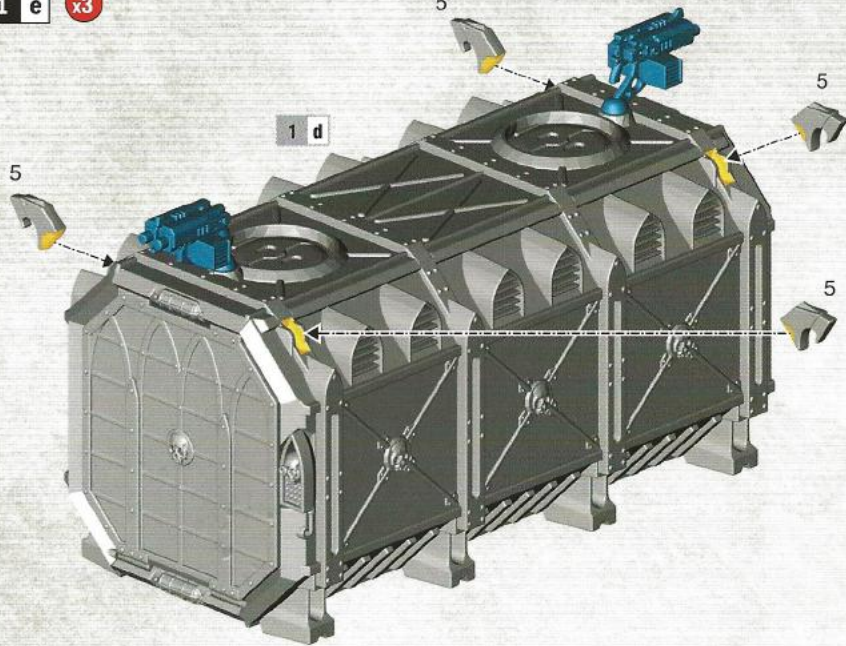

2 x9

9

10

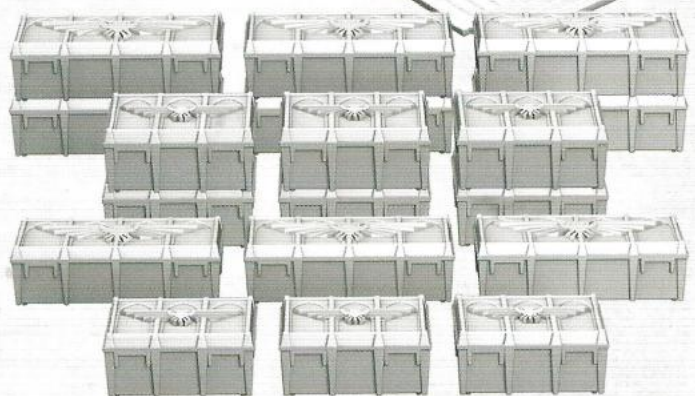
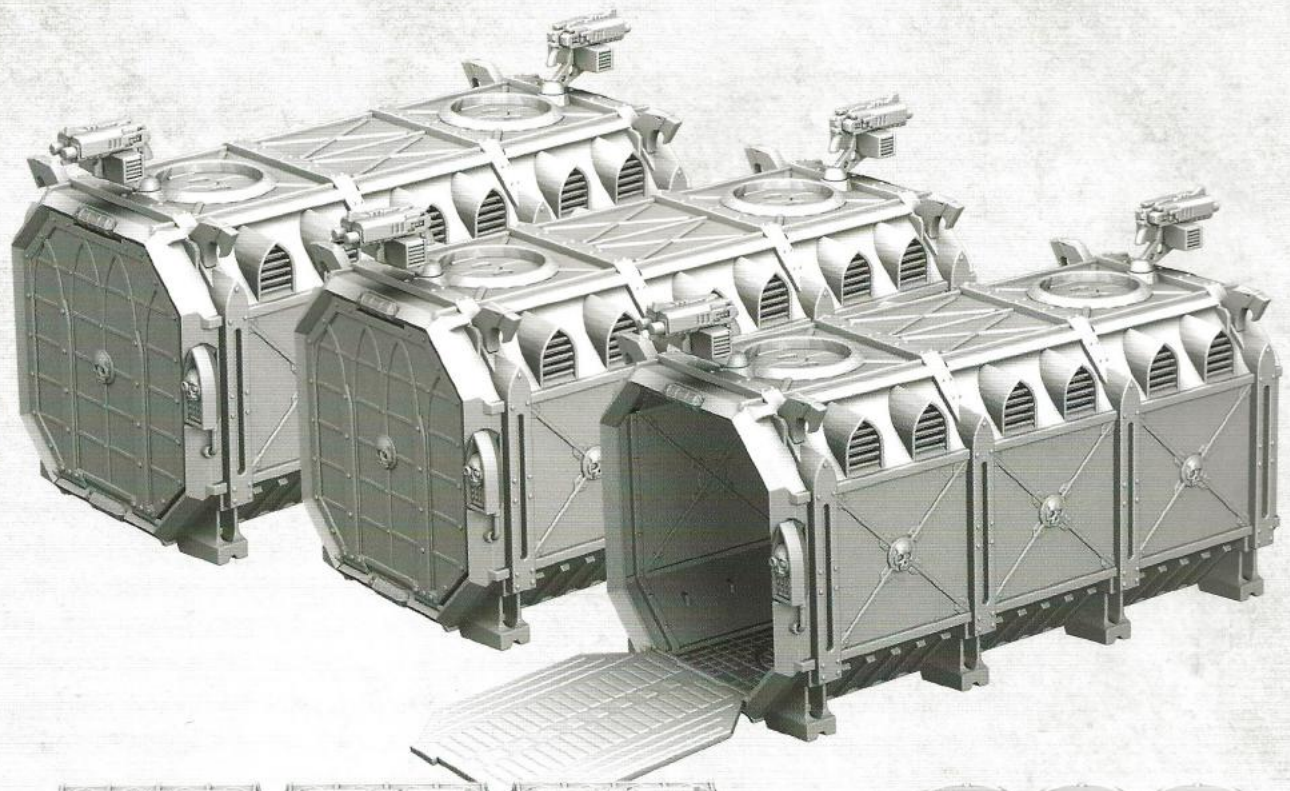

warhammer.com

Games Workshop Limited, Willow Road, Nottingham, NG7 2WS, UK
© Copyright Games Workshop Limited 2020.

