



Free Downloads of Build Instructions,
Assembly Booklets & How To Guides

BuildInstructions.com

CHOOSE THE VARIANT YOU WANT TO BUILD • CHOISISSEZ LA VARIANTE À ASSEMBLER • ELIGE QUÉ VERSIÓN QUIERES MONTAR
WÄHLE DIE VARIANTE, DIE DU BAUEN MÖCHTEST • SCEGLI LA VARIANTE CHE VUOI ASSEMBLARE

STORMCAST ETERNALS

LORD-CELESTANT ON STARDRAKE

STEPS
ÉTAPES • PASOS
SCHRITTE • FASI

1 - 17



DRAKESWORN TEMPLAR ON STARDRAKE

STEPS
ÉTAPES • PASOS
SCHRITTE • FASI

1 - 15;
18 - 19



Special instruction - Please read
 Instructions spéciales - Lire attentivement
 Instrucción especial: Por favor, léela
 Besondere Anweisung - Bitte lesen
 Istruzioni speciali - Leggi attentamente



Stage complete
 Étape terminée
 Paso completado
 Schritt abgeschlossen
 Fase completa



Detail view
 Vue détaillée
 Vista detallada
 Alternative Ansicht
 Visuale del dettaglio



Dry fit stage before gluing
 Tester avant de coller
 Comprobar el encaje antes de pegar
 Positionierung erst ohne Klebstoff ausprobieren
 Prova a secco prima di incollare



Choice of parts
 Choix d'éléments
 Modelos de componentes
 Auswahl an Teilen
 Scelta di componenti



Repeat process
 Répéter l'étape
 Repetir pasos
 Vorgang wiederholen
 Ripeti il processo



Variant assembly
 Variante d'assemblage
 Variante de montaje
 Bauvariante
 Assemblaggio alternativo



Do not glue the components
 Ne pas coller les éléments
 No pegar los componentes
 Bitte die Teile nicht kleben
 Non incollare i componenti



Rotate part
 Faire pivoter
 Girar la pieza
 Teil drehen
 Ruota il componente



READ THIS FIRST: Before assembling your model kit please read through the instructions in this booklet carefully. A pair of plastic cutters is required to remove the plastic components in this kit from their frame. We advise using a mouldline scraping tool to clean up the parts. To assemble your model you will need plastic glue. Games Workshop sells Citadel Fine Detail Cutters, Citadel Mouldline Remover and Citadel Plastic Glue, but does not recommend these products for use by children under the age of 16 without adult supervision.

À LIRE EN PREMIER : Avant de vous lancer dans l'assemblage de ce kit, veuillez lire attentivement les instructions de ce livret. Une pince coupante est requise pour détacher chaque élément de sa grappe. Nous vous recommandons l'utilisation d'un grattoir pour ébarber les éléments. Pour l'assemblage, vous aurez également besoin de colle plastique. Games Workshop commercialise les Pinces de Précision Citadel, l'Ébarboir Citadel et la Colle Plastique Citadel, mais n'en recommande pas l'utilisation pour des enfants de moins de 16 ans sans la supervision d'un adulte.

LEER ANTES DE MONTAR: Antes de montar el contenido de este kit, lee estas instrucciones cuidadosamente. Te harán falta unas tenazas para plástico a fin de separar las piezas de la matriz. También aconsejamos una herramienta para rebabas a fin de limpiar cada pieza. Para montar la miniatura necesitarás pegamento para plástico. Games Workshop vende Tenazas Citadel, Herramientas para rebabas Citadel y Pegamento para plástico Citadel, pero no recomienda estos productos a menores de 16 años sin la supervisión de un adulto.

LIES DIES ZUERST: Bitte lies diese Anleitung sorgfältig, bevor du mit dem Zusammenbau deines Modells beginnst. Du benötigst einen Kunststoffseitenschneider, um die Kunststoffbauteile aus dem Gussrahmen herauszutrennen, und Kunststoffkleber, um die Miniatur zusammenzubauen. Außerdem empfehlen wir, die Bauteile vorher mit einem Gussgratentferner zu säubern. Games Workshop bietet Präzisions-Kunststoffseitenschneider von Citadel sowie Citadel-Kunststoffkleber an, empfiehlt aber, dass Kinder unter 16 Jahren diese nur unter Aufsicht eines Erwachsenen benutzen.

LEGGI PRIMA QUESTO: prima di assemblare il tuo modello, leggi le istruzioni di questo libretto con attenzione. Sono necessarie un paio di tronchesine per plastica per staccare i componenti dai loro sprue. Consigliamo di usare un attrezzo apposito per pulire i componenti. Per assemblare il modello avrai bisogno di colla per plastica. Games Workshop vende Tronchesine di precisione Citadel, Attrezzo per ripulire Citadel e Colla per plastica Citadel, ma non consiglia questi prodotti ad un pubblico minore di 16 anni senza la supervisione di un adulto.

16+
 ATTENZIONE • AGE • AGE • AGEN
 16+



Citadel plastic glue thick
 Colle plastique épaisse Citadel
 Pegamento para plástico espeso
 Citadel-kunststoffkleber (Dickflüssig)
 Colla per plastica densa Citadel



Citadel plastic glue thin
 Colle plastique liquide Citadel
 Pegamento para plástico fluido
 Citadel-kunststoffkleber (Dünnflüssig)
 Colla per plastica fluida Citadel



Citadel fine detail cutters
 Pinces de précision Citadel
 Tenazas Citadel
 Präzisions-kunststoffseitenschneider
 Tronchesine di precisione Citadel



Citadel mouldline remover
 Ébarboir Citadel
 Herramienta para rebabas Citadel
 Gussgratentferner
 Attrezzo per ripulire Citadel



Follow step 1-15 for all variants • Suivre les étapes 1-15 pour toutes les variantes • Sigue los pasos 1-15 para todas las variantes
 Folge den Schritten 1-15 für alle Varianten • Segui le fasi da 1 a 15 per tutte le varianti

1 a



1 b

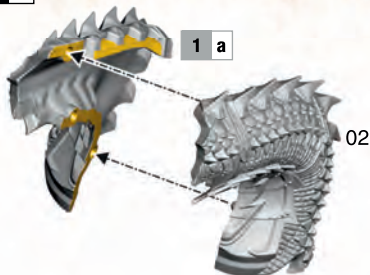

1 c

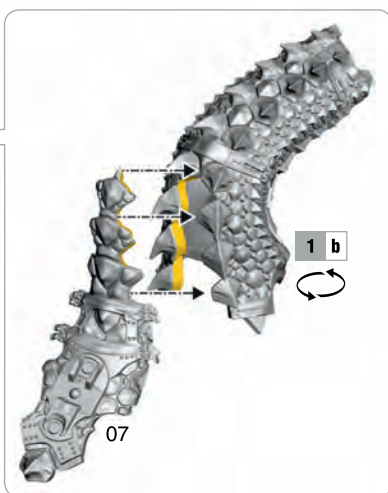
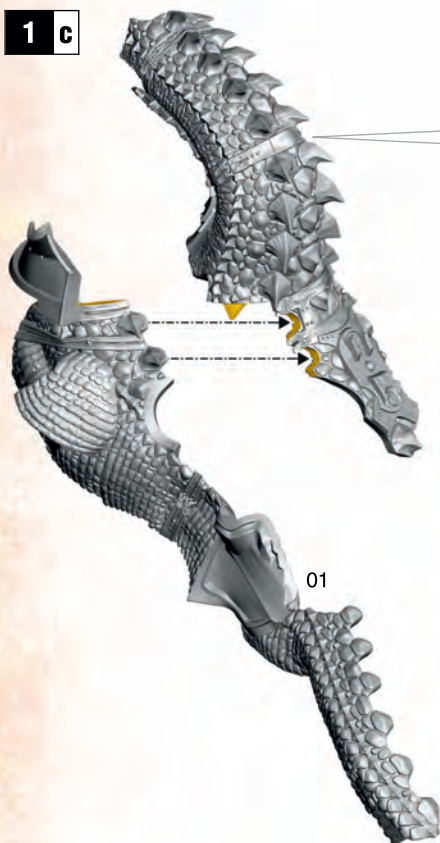

1 d

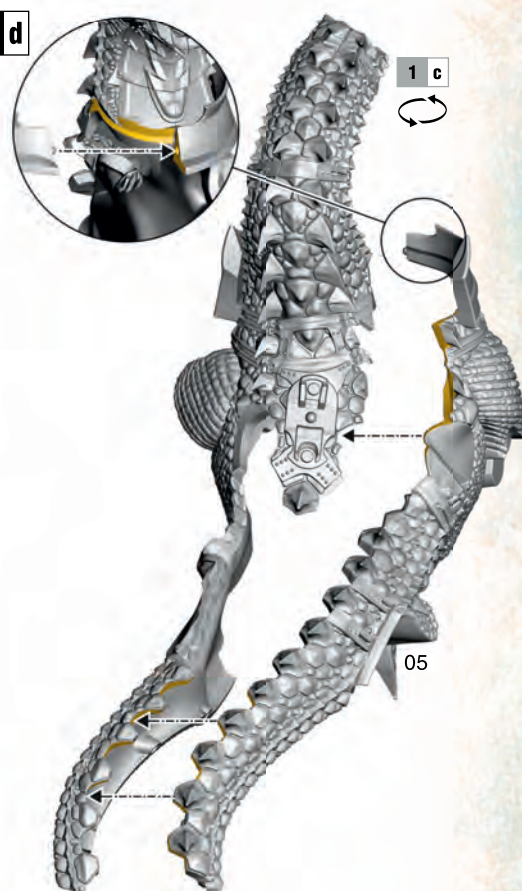

1 e

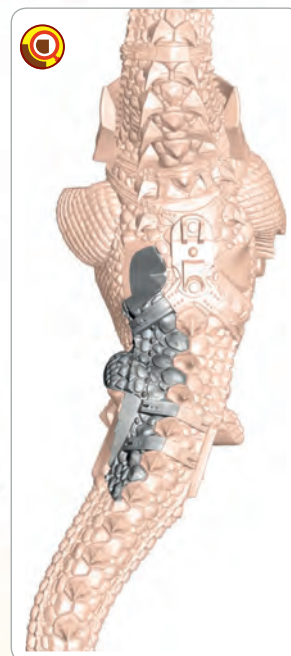
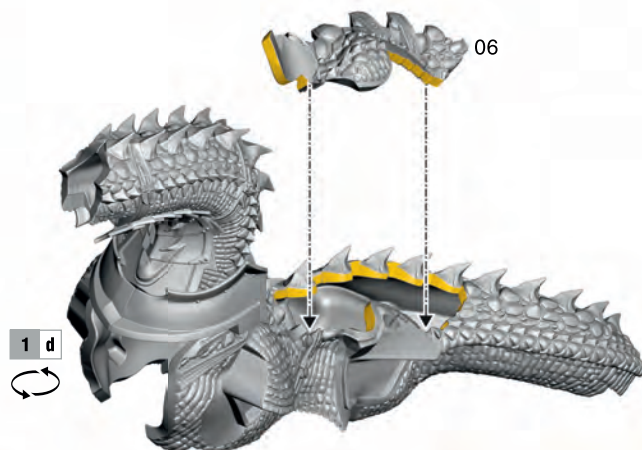

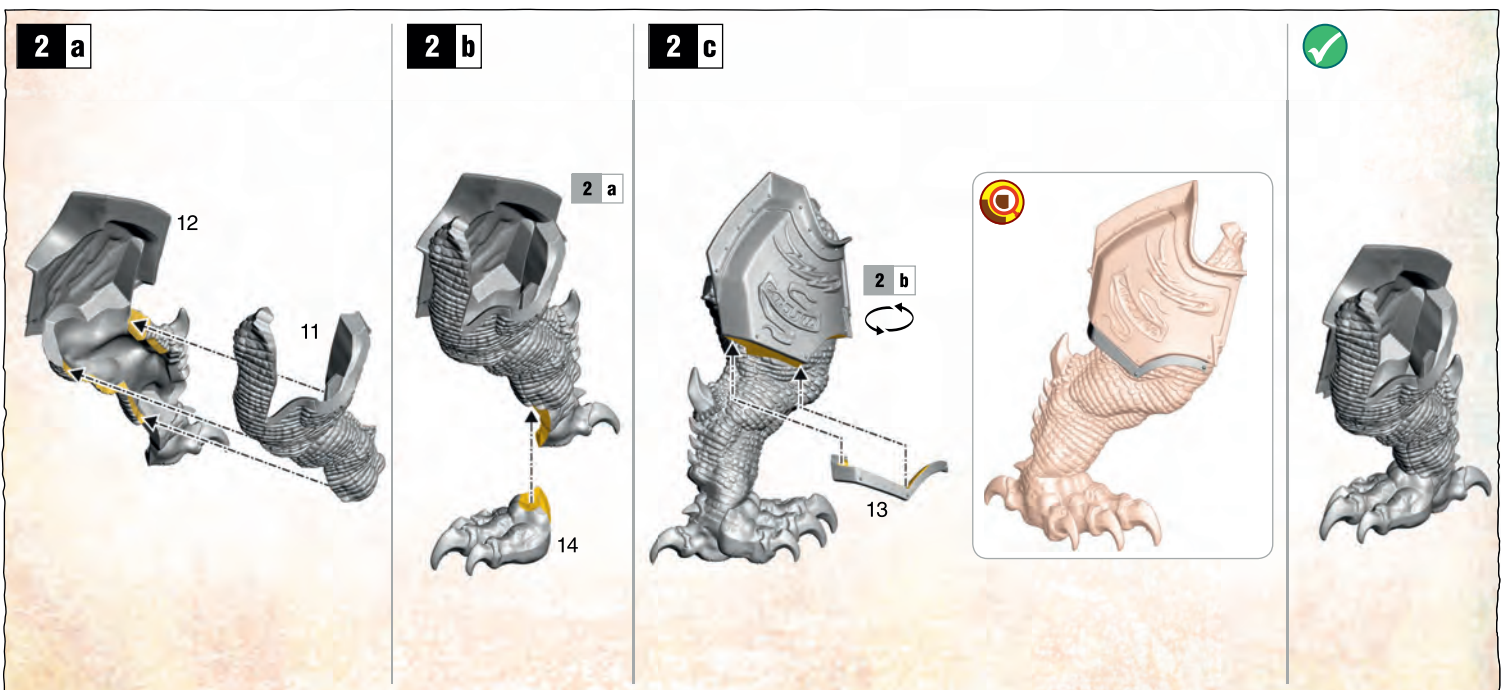
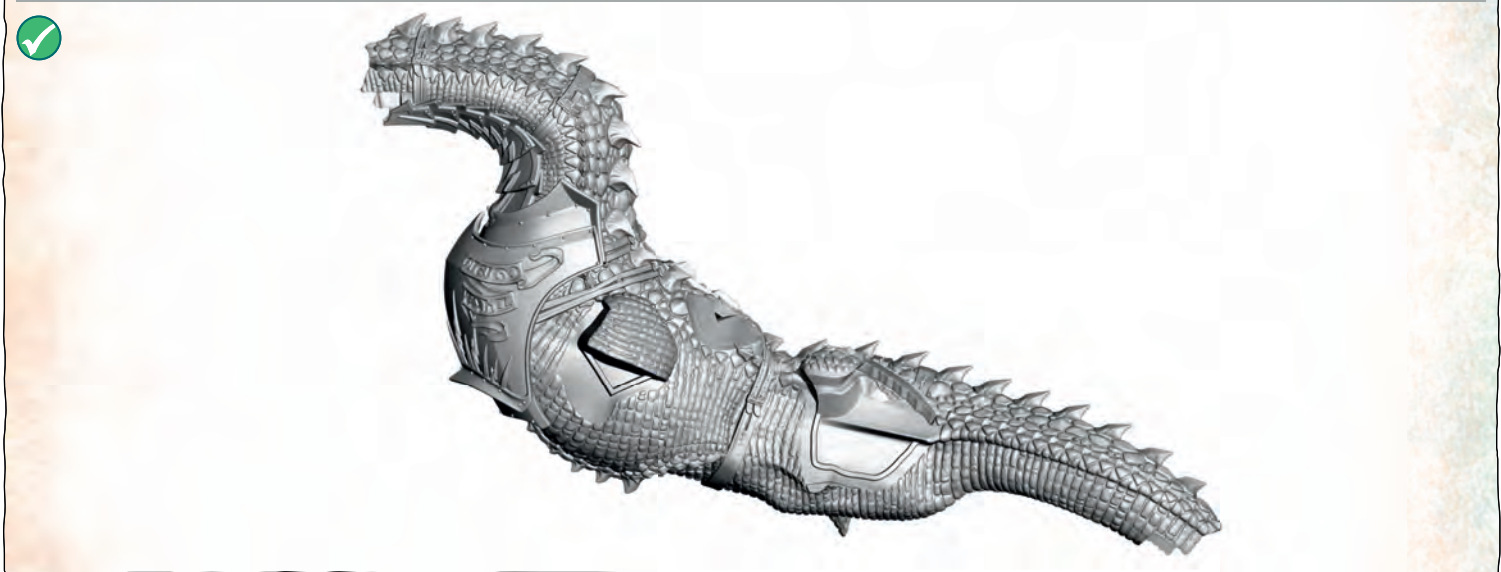
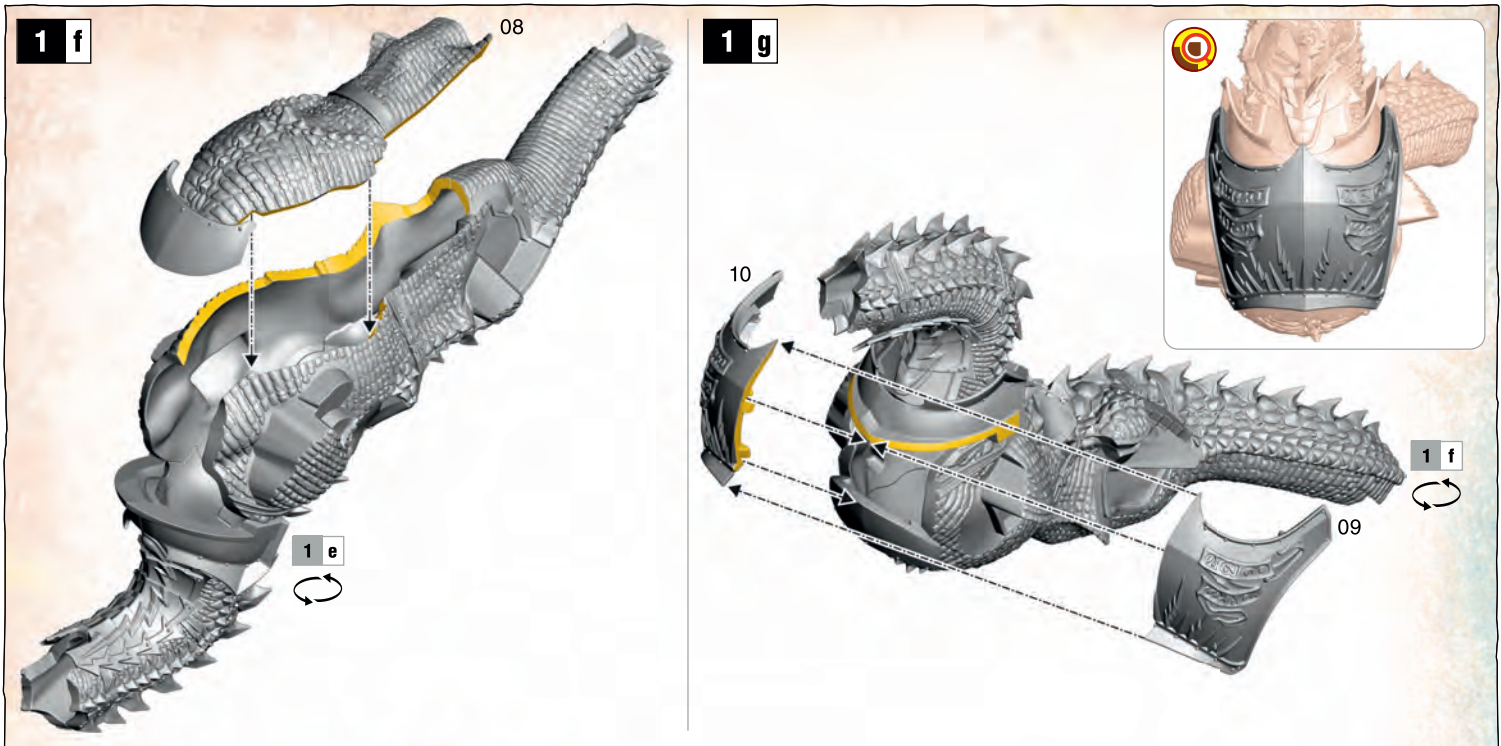

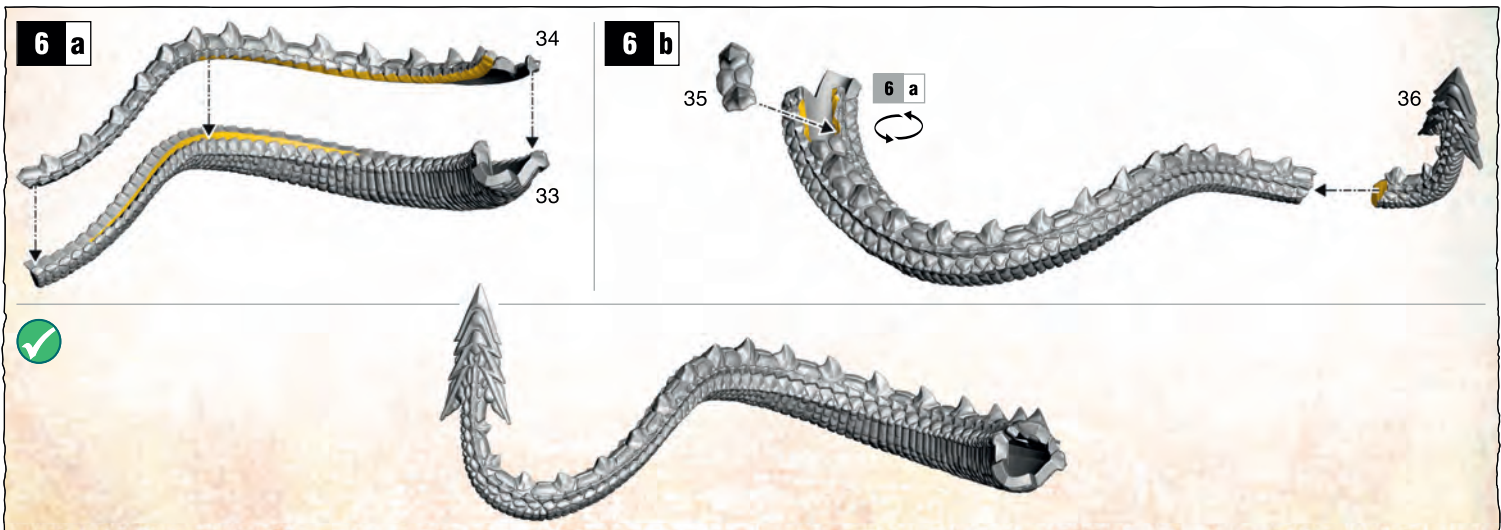
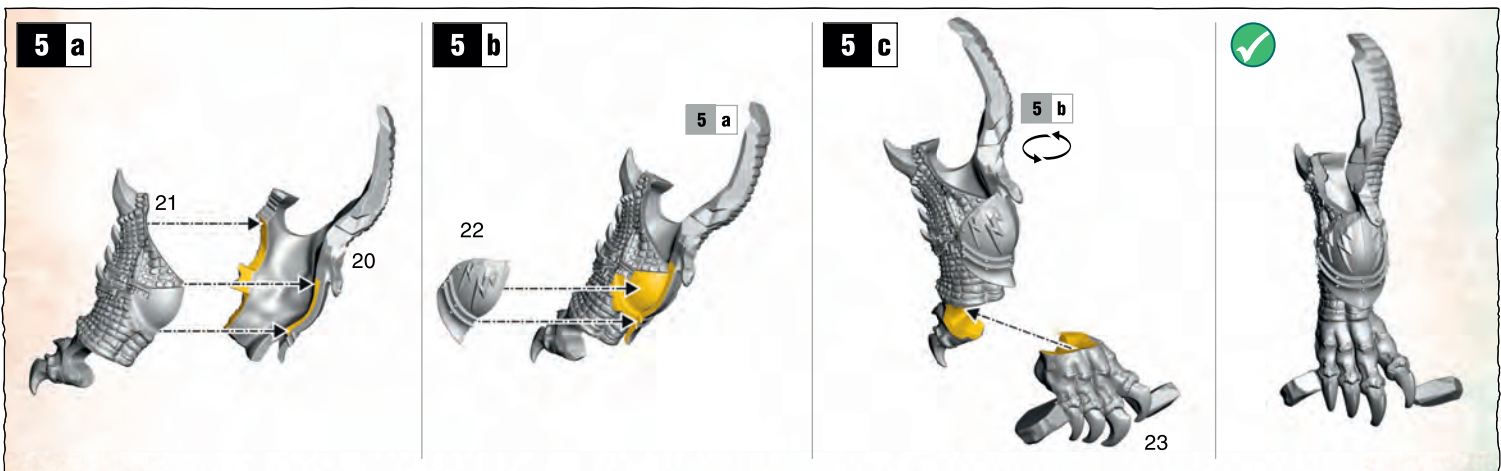
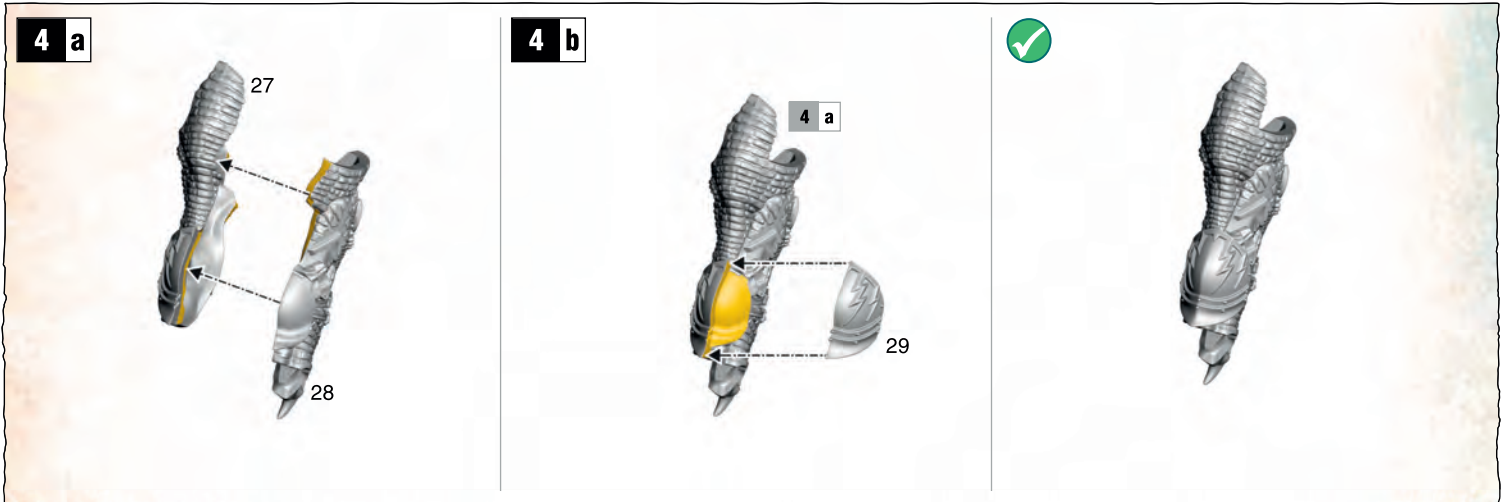
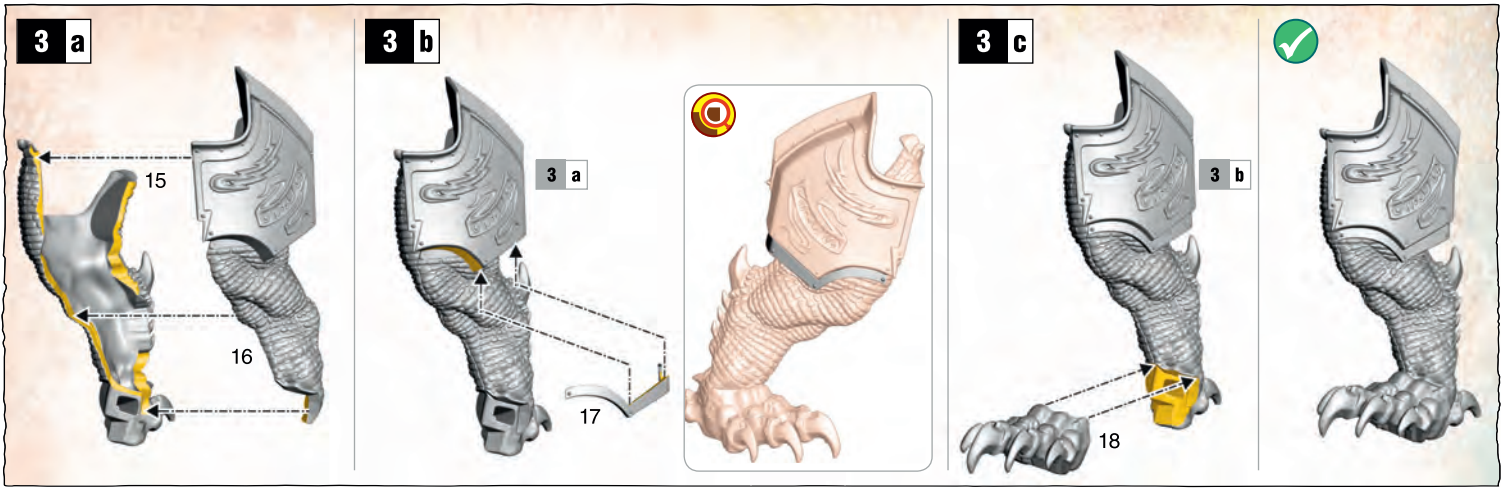

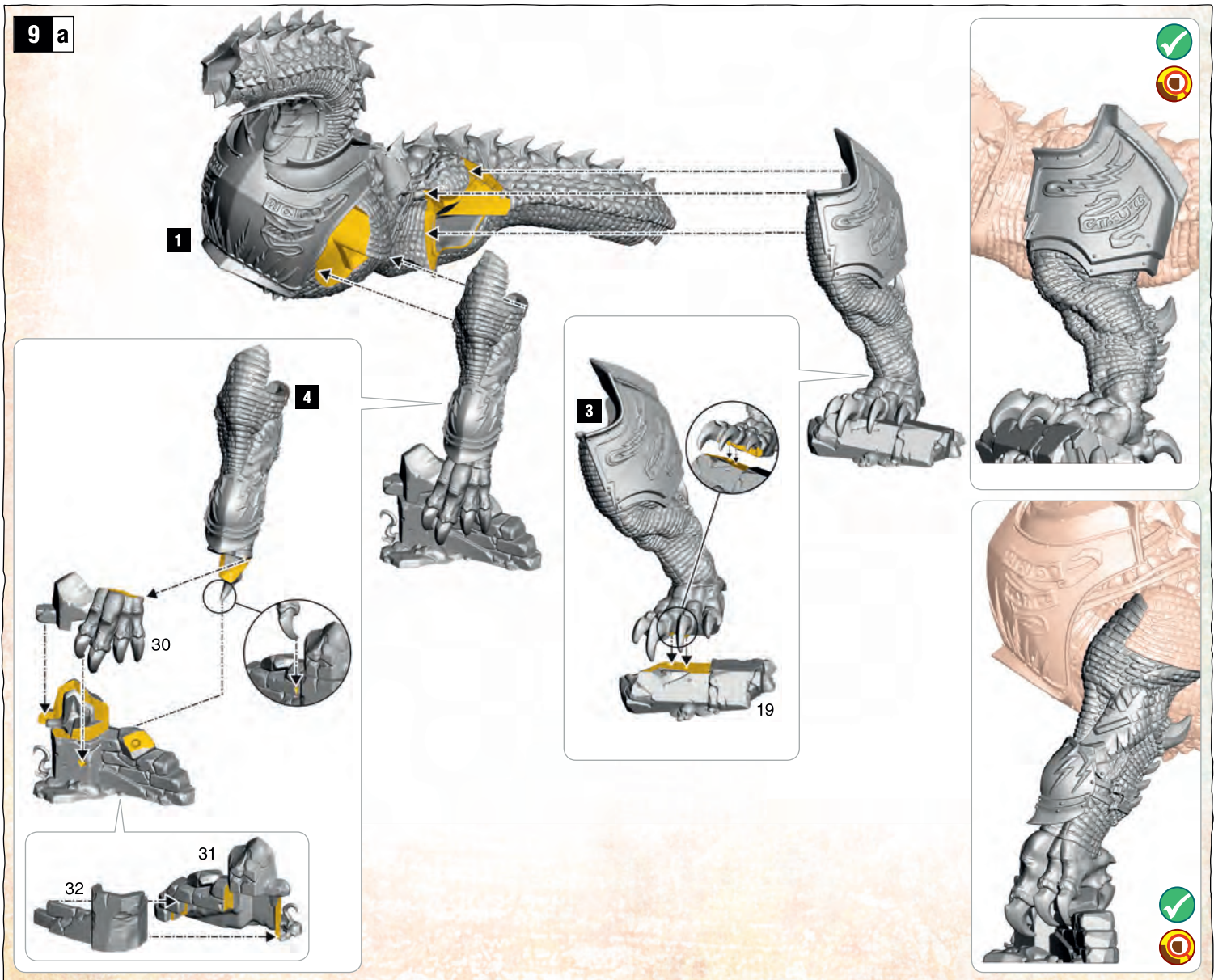
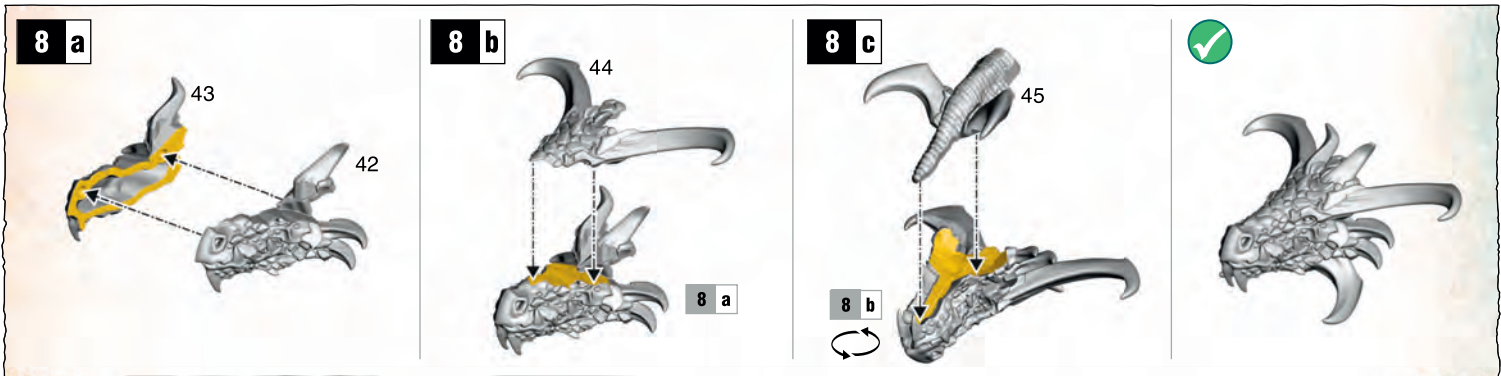
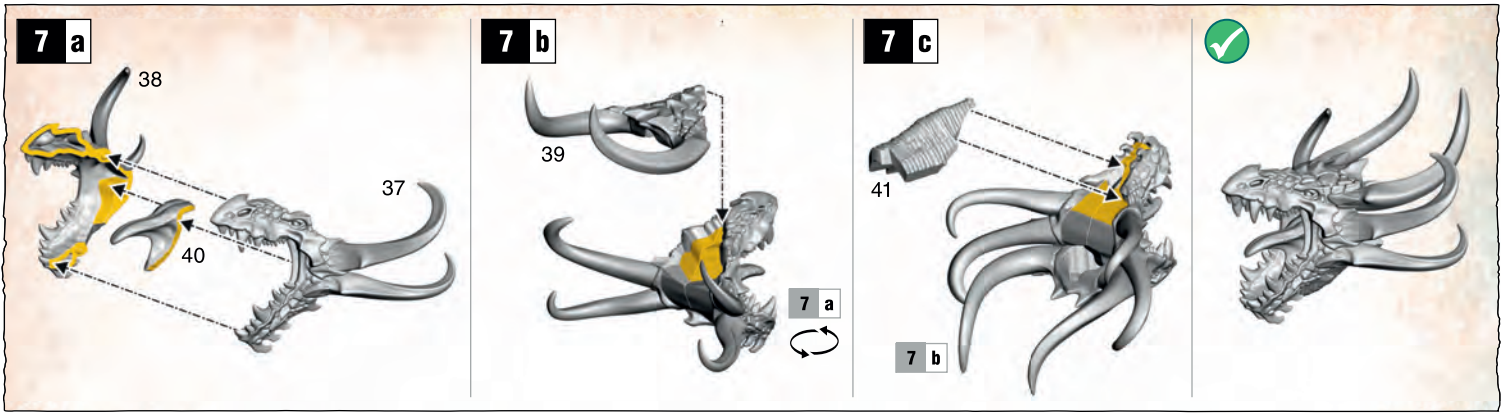

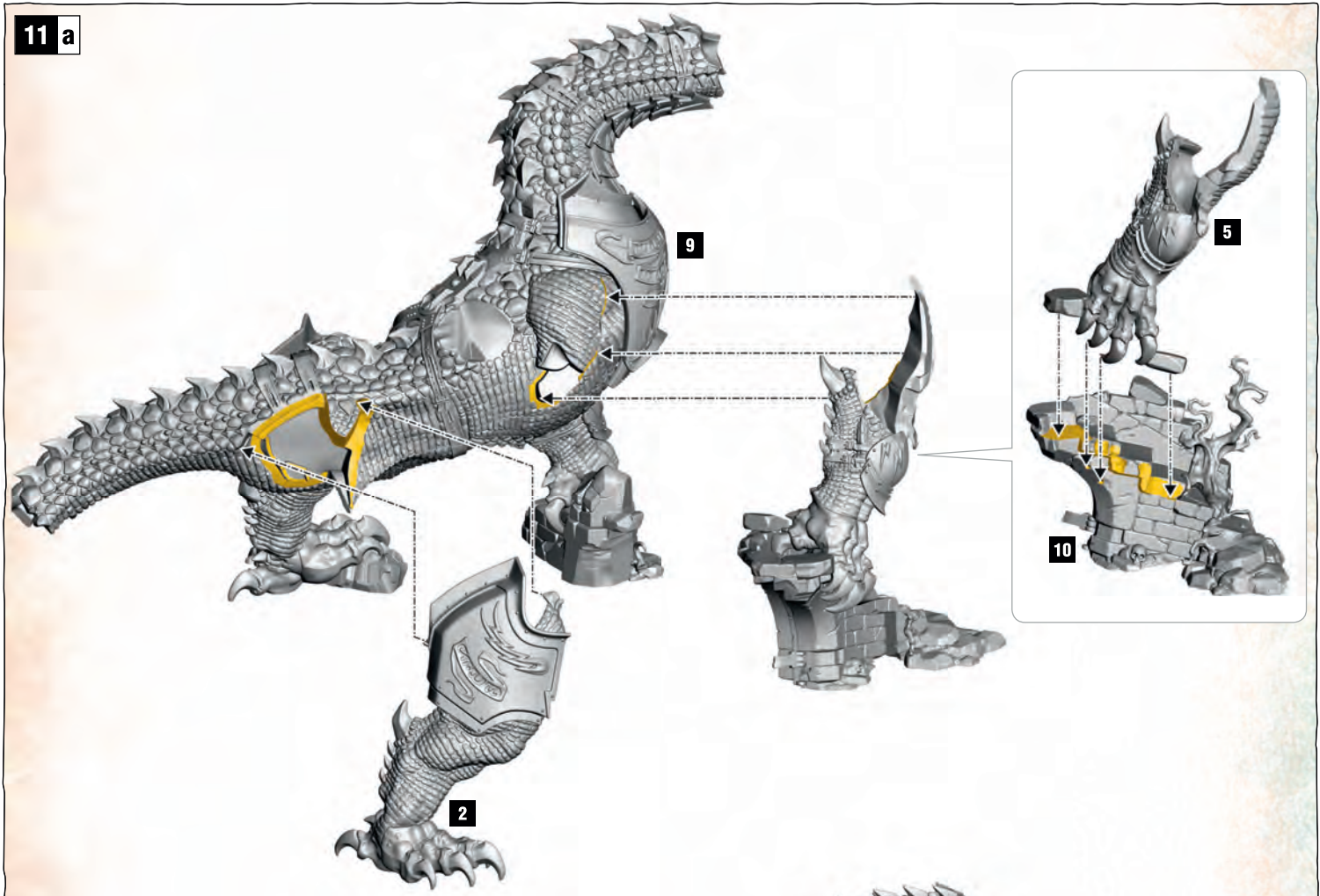
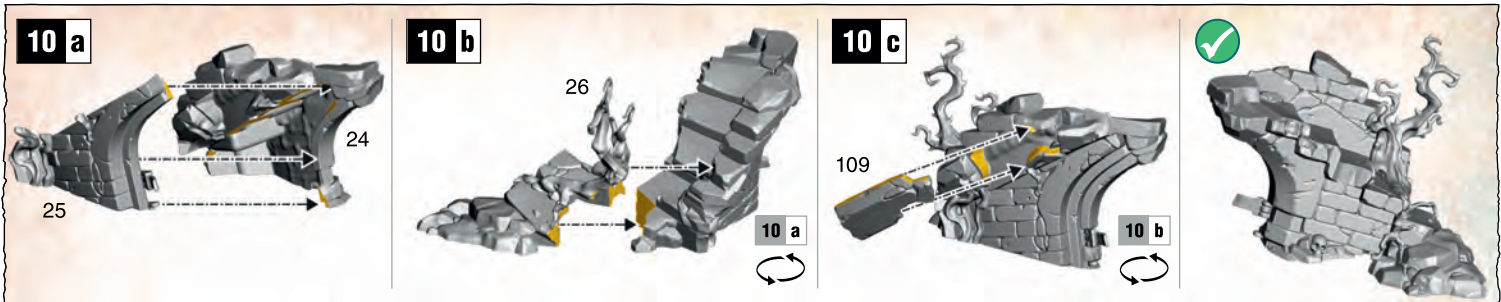

12 a

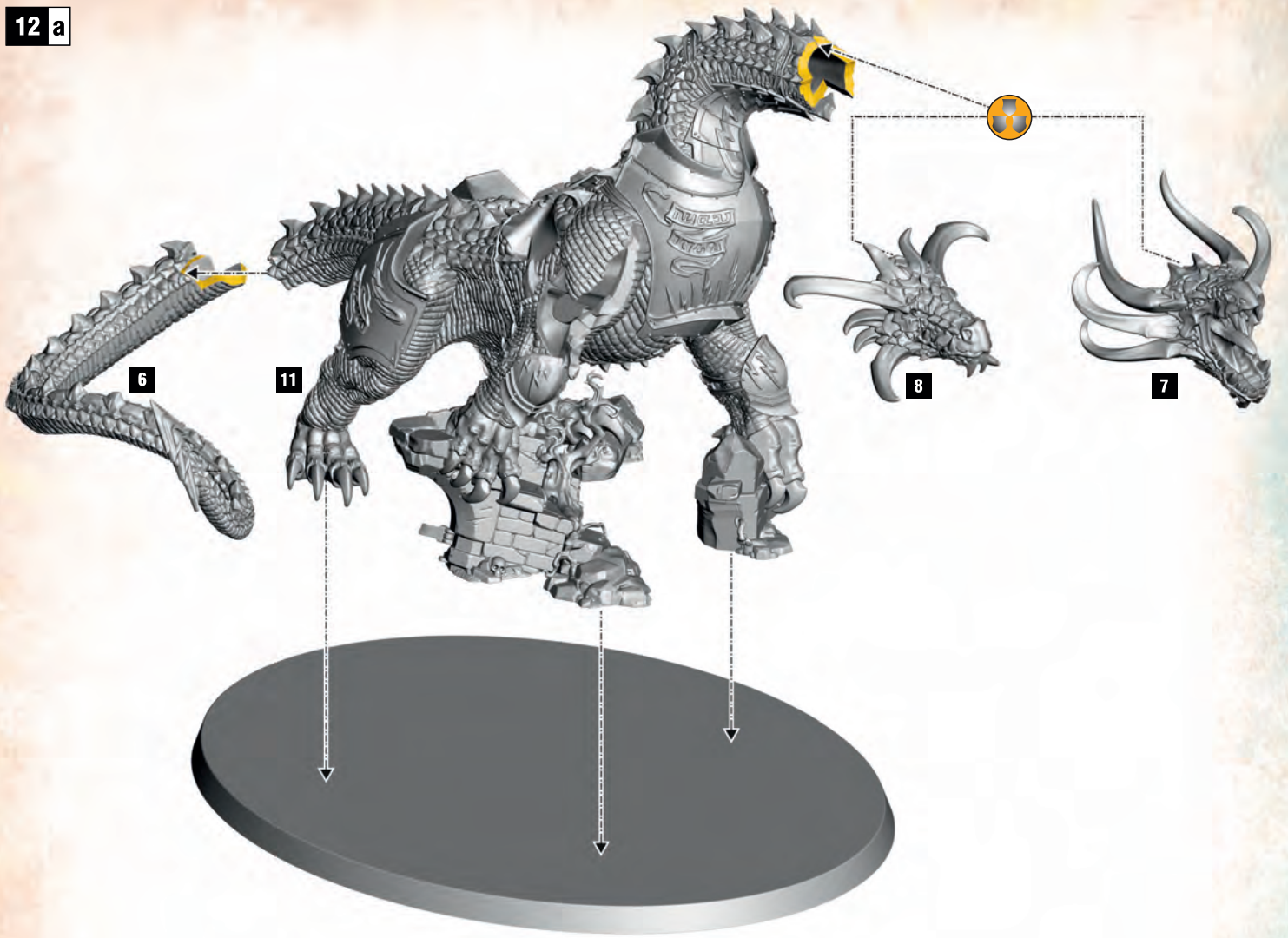

13 a

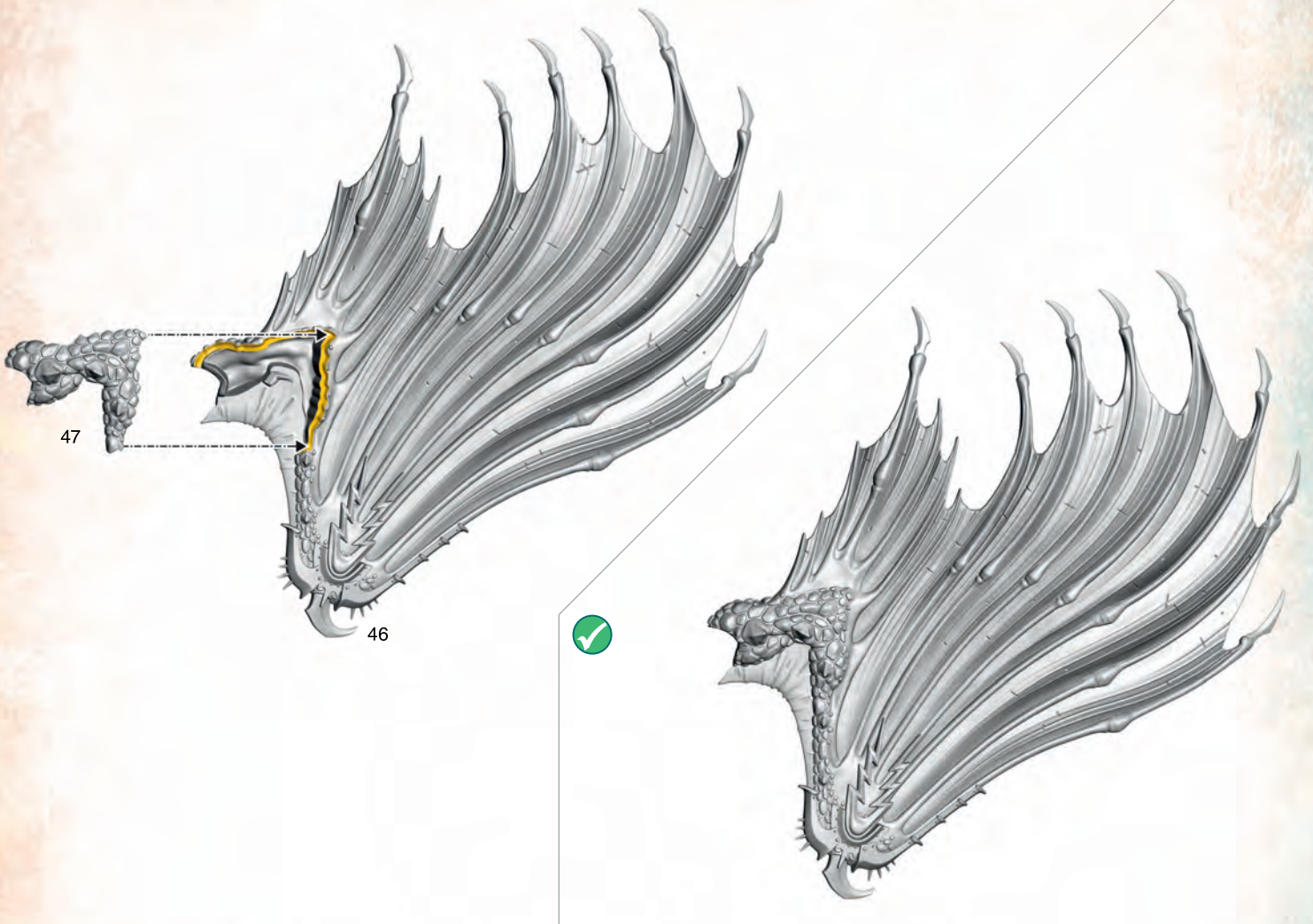

14 a

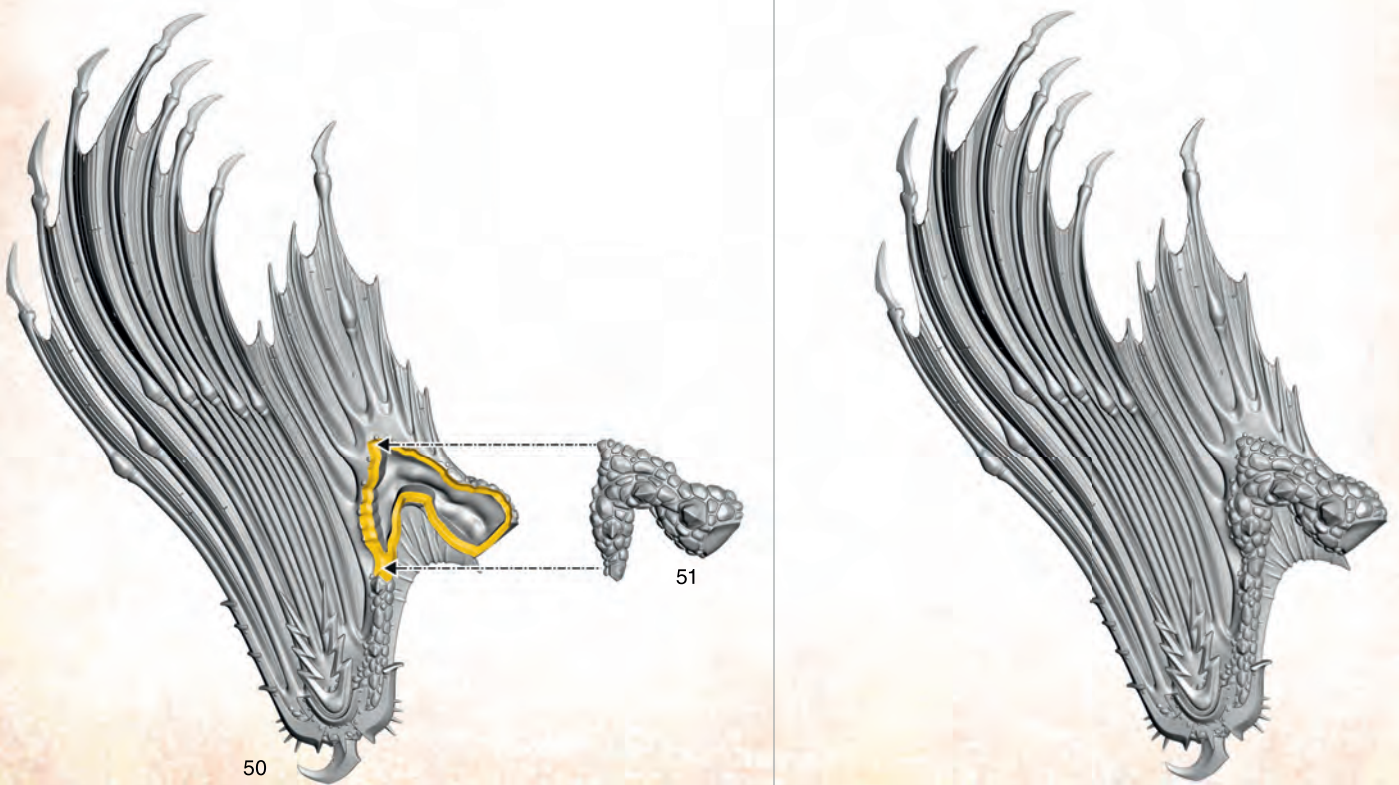

15 a

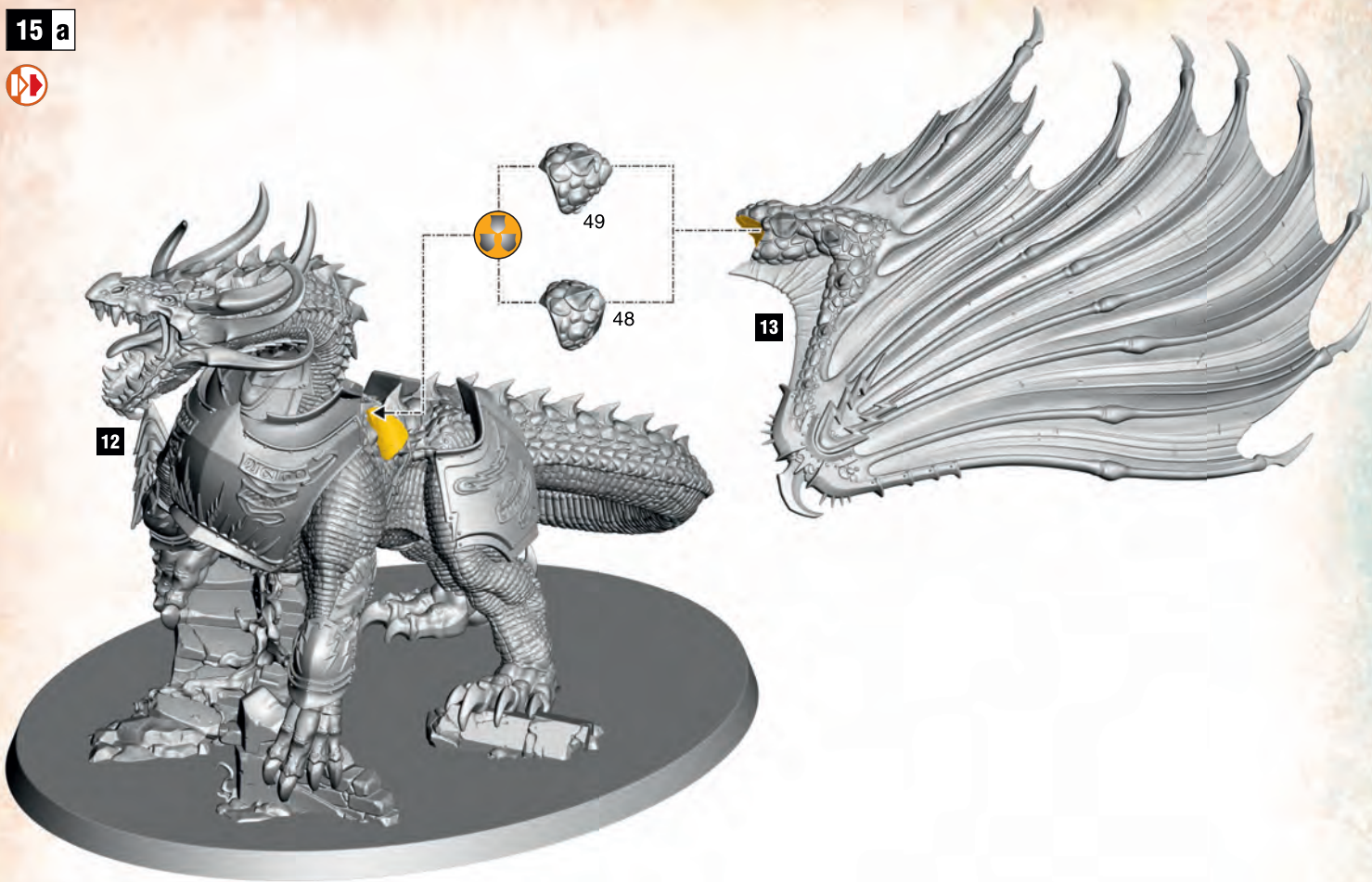

15 b

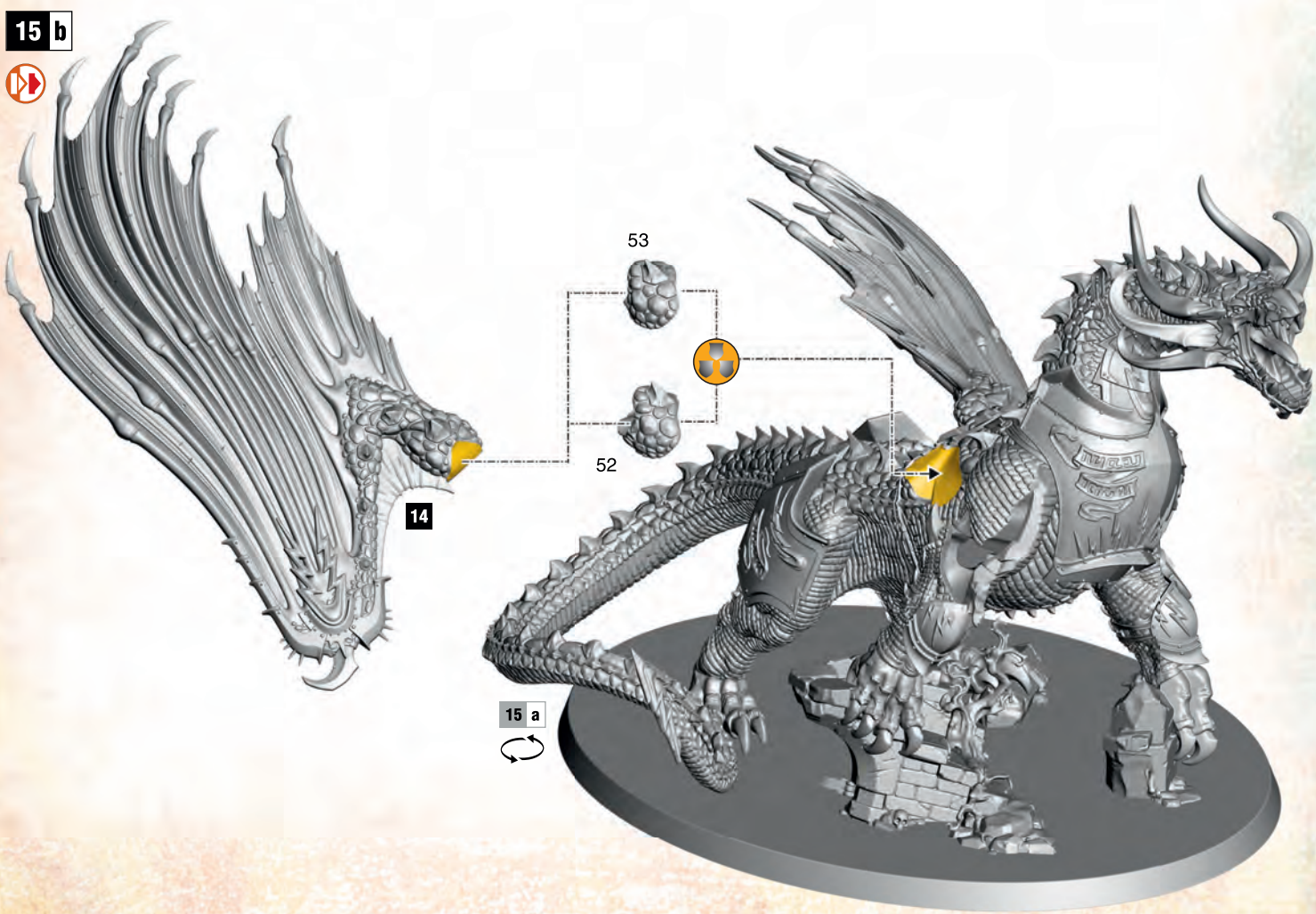

16 - 17 LORD CELESTANT ON STARDRAKE

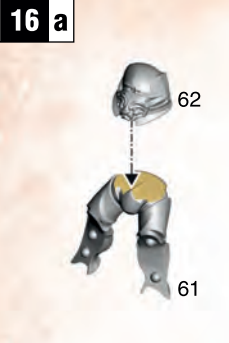
16 a 

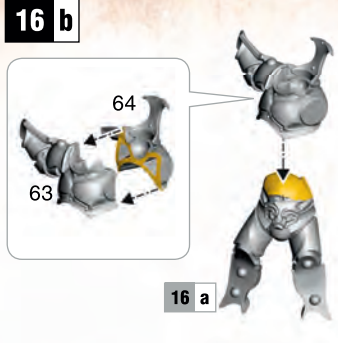
16 b 

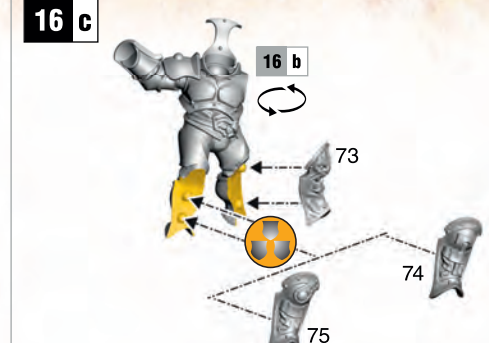
16 c 

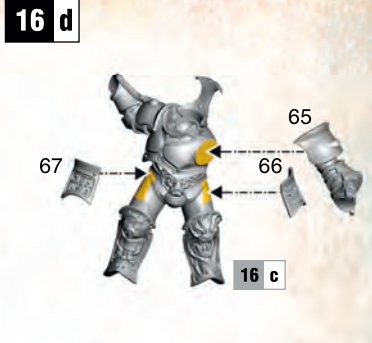
16 d 

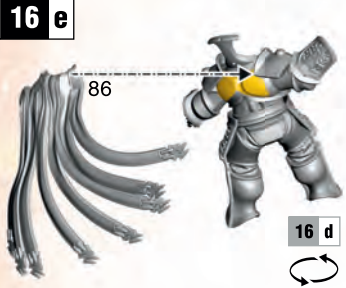
16 e 

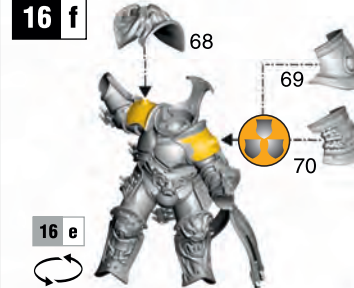
16 f 

Hammers of Sigmar 

Scions of Sigmar 

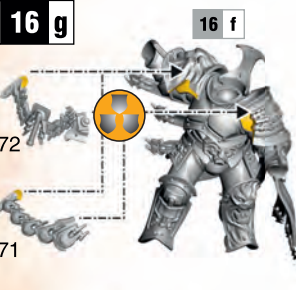
16 g 

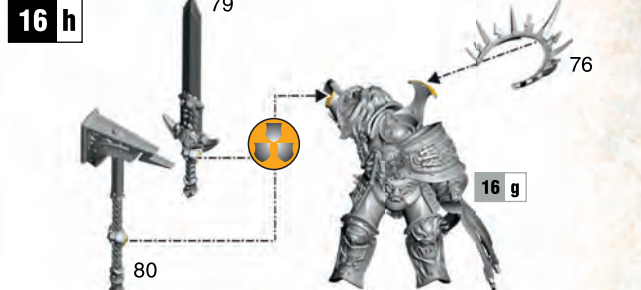
16 h 

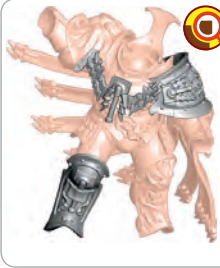
Hammers of Sigmar 

Scions of Sigmar 

16 i 

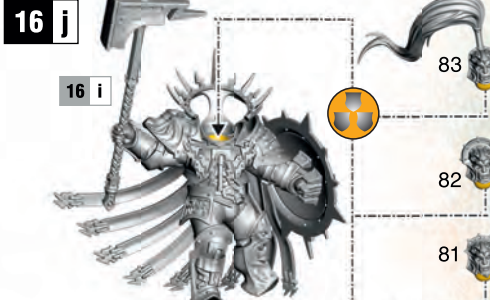
16 j 

Hammers of Sigmar 

Scions of Sigmar 

16 k 

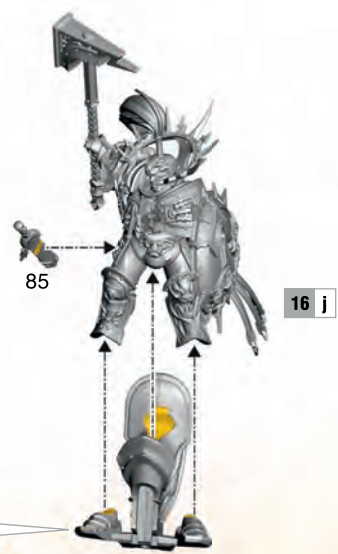
16 l 

Hammers of Sigmar 

Scions of Sigmar 

17 a

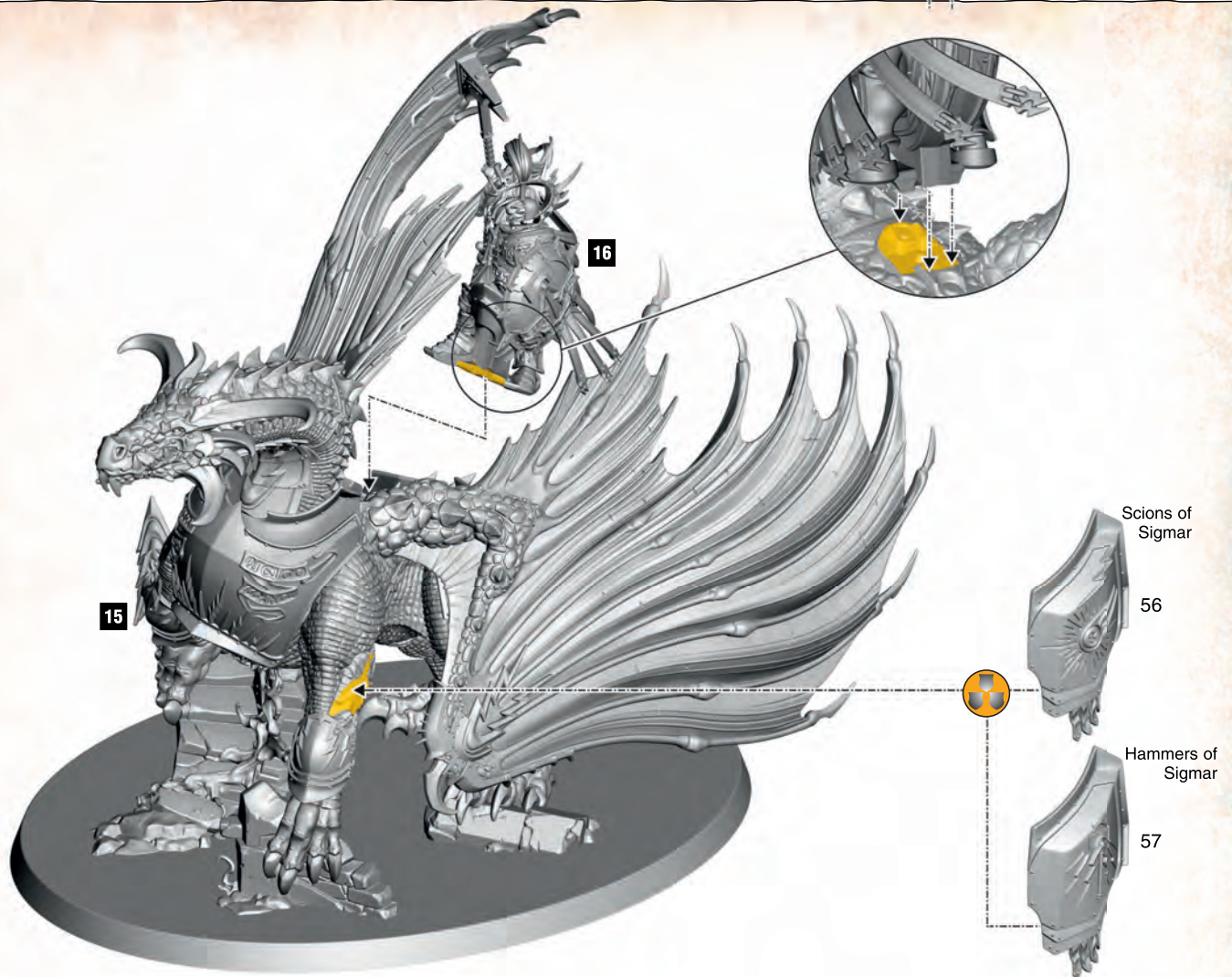

Hammers of Sigmar



Scions of Sigmar

17 b



Hammers of Sigmar



Scions of Sigmar



LORD CELESTANT ON STARDRAKE

MOVE
 WOUNDS 16
 BRAVERY 9
 SAVE 3+



MELEE WEAPONS	Range	Attacks	To Hit	To Wound	Rend	Damage
Celestine Hammer	2"	3	3+	2+	-1	D3
Stormbound Blade	2"	3	3+	4+	-1	2
Stardrake's Great Claws	1"	4	*	3+	-1	D3

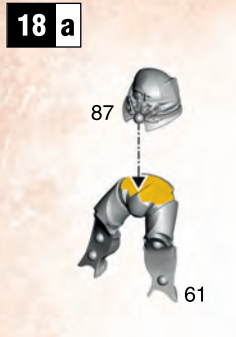
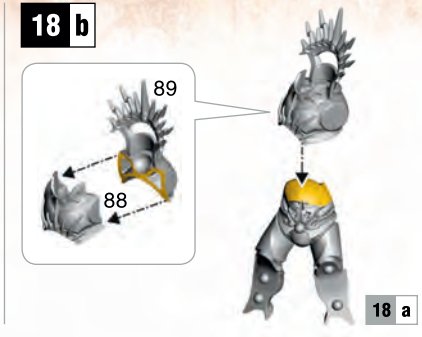
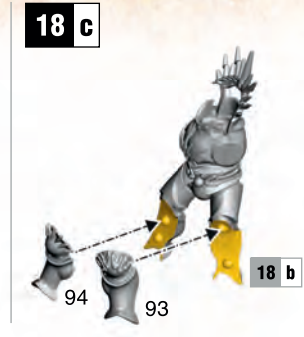
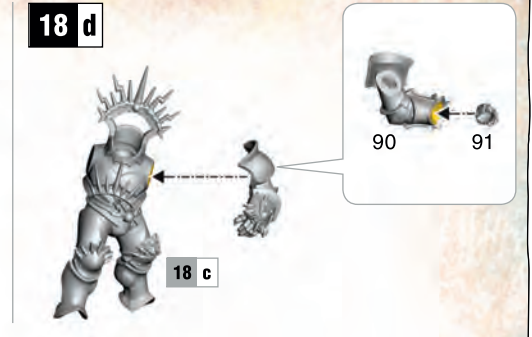

Wounds Suffered	DAMAGE TABLE		
	Move	Great Claws	Cavernous Jaws
0-4	12"	3+	3
5-8	11"	3+	3
9-11	10"	4+	2
12-13	8"	4+	2
14+	6"	5+	1

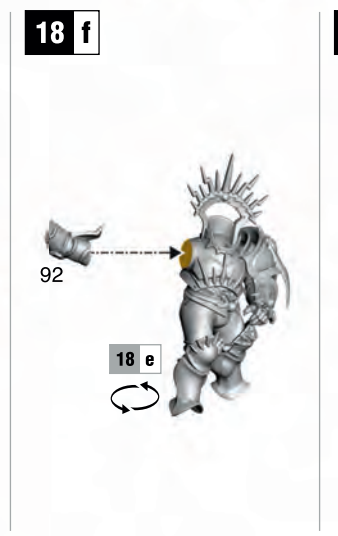
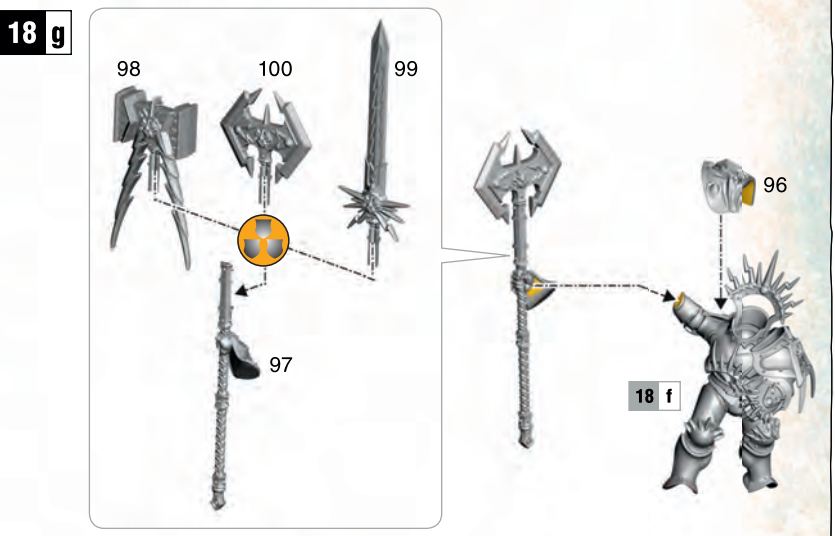
18 - 19 DRAKESWORN TEMPLAR

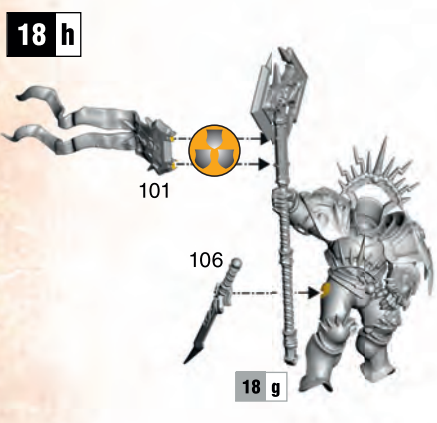
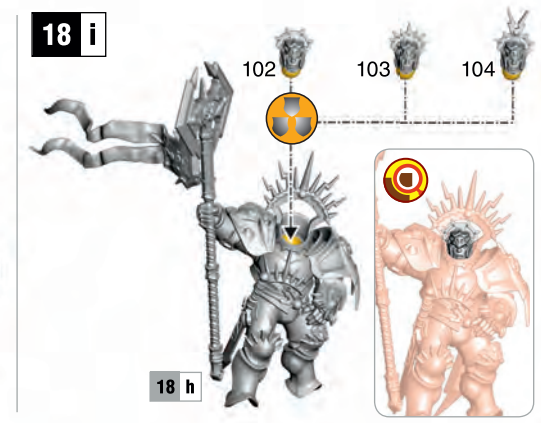
18 a  **18 b**  **18 c**  **18 d** 

18 e  **18 f**  **18 g** 

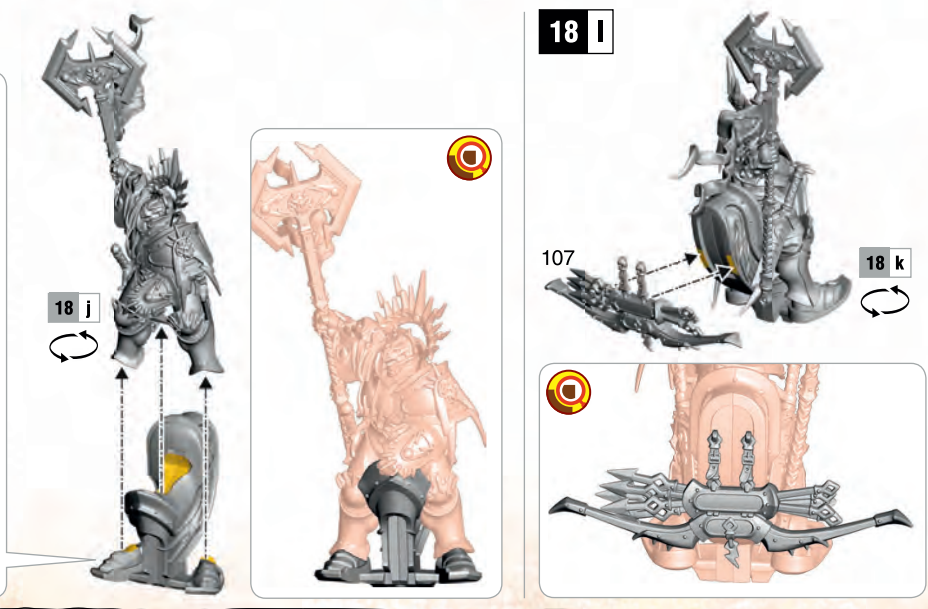
18 h  **18 i**  **18 j** 

18 k  **18 l**  

19 a

19 a

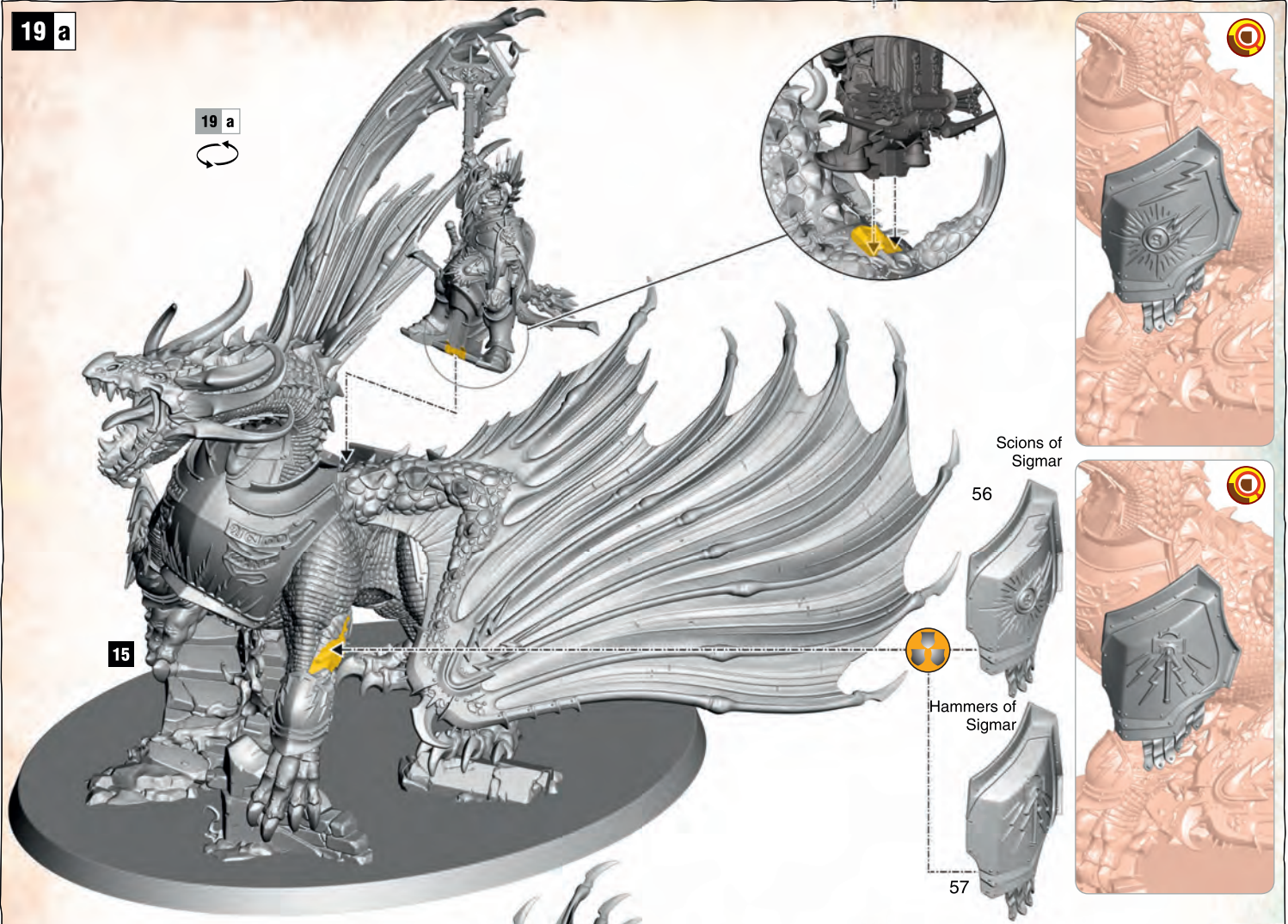

15

Scions of Sigmar

56

Hammers of Sigmar

57

19 b



Scions of Sigmar

54



Hammers of Sigmar

55



19 a





DRAKESWORN TEMPLAR

MOVE
 WOUNDS 16
 BRAVERY 9
 SAVE 3+

MISSILE WEAPONS		Range	Attacks	To Hit	To Wound	Rend	Damage
Skybolt Bow		24"	1	3+	3+	-1	1
MELEE WEAPONS		Range	Attacks	To Hit	To Wound	Rend	Damage
Tempest Axe		2"	6	3+	3+	-	1
Arc Hammer		1"	2	3+	3+	-1	3
Stormlance		3"	3	3+	3+	-1	2
Stardrake's Great Claws		1"	4	*	3+	-1	D3

DAMAGE TABLE			
Wounds Suffered	Move	Great Claws	Cavernous Jaws
0-4	12"	3+	3
5-8	11"	3+	2
9-11	10"	4+	2
12-13	8"	4+	1
14+	6"	5+	1