



Free Downloads of Build Instructions,  
Assembly Booklets & How To Guides

**BuildInstructions.com**

# WARHAMMER

AGE OF SIGMAR

• CHOOSE THE VARIANT YOU WANT TO BUILD  
• CHOISISSEZ LA VARIANTE À ASSEMBLER • ELIGE QUÉ VERSIÓN QUIERES MONTAR  
• WÄHLE DIE VARIANTE, DIE DU BAUEN MÖCHTEST • SCEGLI LA VARIANTE CHE VUOI ASSEMBLARE

## AVENTIS FIRESTRIKE MAGISTER OF HAMMERHAL



### LORD-ARCANUM



STEPS  
ETAPES • PASOS  
SCHRITTE • FASI

6

STEPS  
ETAPES • PASOS  
SCHRITTE • FASI

1 - 5

CITADEL

© Copyright 2018 Games Workshop Ltd. All rights reserved.



993202180147

# LORD-ARCANUM ON TAURALON





• **READ THIS FIRST** • À LIRE EN PREMIER  
 • **LEER ANTES DE MONTAR** • LIES DIES ZUERST  
 • **LEGGI PRIMA QUESTO**

**ENG** BEFORE ASSEMBLING YOUR MINIATURES PLEASE READ THROUGH THE INSTRUCTIONS IN THIS BOOKLET CAREFULLY. A pair of plastic cutters is required to remove the plastic components in this kit from their frame. We advise using a mouldline scraping tool to clean up the parts. To assemble your model you will need plastic glue. Games Workshop sells Citadel Fine Detail Cutters, Citadel Mouldline Remover and Citadel Plastic Glue, but does not recommend these products for use by children under the age of 16 without adult supervision.

**FRE** AVANT D'ASSEMBLER VOS FIGURINES, VEUILLEZ LIRE ATTENTIVEMENT LES INSTRUCTIONS DE CE LIVRET. Une pince coupante est requise pour détacher chaque élément de sa grappe. Nous vous recommandons l'utilisation d'un grattoir pour ébarber les éléments. Pour l'assemblage, vous aurez également besoin de colle plastique. Games Workshop commercialise les Pinces de Précision Citadel, l'Ébarboir Citadel et la Colle Plastique Citadel, mais n'en recommande pas l'utilisation pour des enfants de moins de 16 ans sans la supervision d'un adulte.

**SPA** POR FAVOR, LEE CUIDADOSAMENTE ESTE LIBRETO DE INSTRUCCIONES ANTES DE EMPEZAR A MONTAR LAS MINIATURAS. Te harán falta unas tenazas para plástico a fin de separar las piezas de la matriz. También aconsejamos una herramienta para rebabas a fin de limpiar cada pieza. Para montar la miniatura necesitarás pegamento para plástico. Games Workshop vende Tenazas Citadel, Herramientas para rebabas Citadel y Pegamento para plástico Citadel, pero no recomienda estos productos a menores de 16 años sin la supervisión de un adulto.

**GER** VOR DEM ZUSAMMENBAU DER MINIATUREN BITTE DIE ANWEISUNGEN IN DIESER ANLEITUNG AUFMERKSAM DURCHLESEN. Du benötigst einen Kunststoffseitenschneider, um die Kunststoffbauteile aus dem Gussrahmen herauszutrennen, und Kunststoffkleber, um die Miniatur zusammenzubauen. Außerdem empfehlen wir, die Bauteile vorher mit einem Gussgratentferner zu säubern. Games Workshop bietet Präzisions-Kunststoffseitenschneider von Citadel sowie Citadel-Kunststoffkleber an, empfiehlt aber, dass Kinder unter 16 Jahren diese nur unter Aufsicht eines Erwachsenen benutzen.

**ITA** PRIMA DI ASSEMBLARE LE TUE MINIATURE LEGGI ATTENTAMENTE TUTTE LE ISTRUZIONI DI QUESTO LIBRETTO. Sono necessarie un paio di tronchesine per plastica per staccare i componenti dai loro sprue. Consigliamo di usare un attrezzo apposito per pulire i componenti. Per assemblare il modello avrai bisogno di colla per plastica. Games Workshop vende Tronchesine di precisione Citadel, Attrezzo per ripulire Citadel e Colla per plastica Citadel, ma non consiglia questi prodotti ad un pubblico minore di 16 anni senza la supervisione di un adulto.

• **EXPLANATION OF SYMBOLS** • **EXPLICATION DES SYMBOLES**  
 • **EXPLICACIÓN DE SIMBOLOS** • **ERLÄUTERUNG DER SYMBOLE**  
 • **LEGENDA DEI SIMBOLI**



- Special instruction - Please read
- Instructions spéciales - Lire attentivement
- Instrucción especial: Por favor, léela
- Besondere Anweisung - Bitte lesen
- Istruzioni speciali - Leggi attentamente



- Choice of parts
- Choix d'éléments
- Modelos de componentes
- Auswahl an Teilen
- Scelta di componenti



- Assembly sequence
- Séquence d'Assemblage
- Secuencia de montaje
- Baureihenfolge
- Sequenza di assemblaggio



- Dry fit stage before gluing
- Tester avant de coller
- Comprobar el encaje antes de pegar
- Positionierung erst ohne Klebstoff ausprobieren
- Prova a secco prima di incollare



- Variant assembly
- Variante d'assemblage
- Variante de montaje
- Bauvariante
- Assemblaggio alternativo



- Stage complete
- Étape terminée
- Paso completado
- Schritt abgeschlossen
- Fase completa

16+



- Citadel plastic glue
- Colle plastique Citadel
- Pegamento para plástico
- Citadel-Kunststoffkleber
- Colla per plastica Citadel



- Citadel fine detail cutters
- Pinces de précision Citadel
- Tenazas Citadel
- Präzisions-Kunststoffseitenschneider
- Tronchesine di precisione Citadel



- Citadel mouldline remover
- Ébarboir Citadel
- Herramienta para rebabas Citadel
- Gussgratentferner
- Attrezzo per ripulire Citadel



· FOLLOW STEPS 1-2 FOR ALL VARIANTS · SUIVRE L'ÉTAPE 1-2 POUR TOUTES LES VARIANTES  
· SIGUE EL PASO 1-2 PARA TODAS LAS VARIANTES · FOLGE SCHRITT 1-2 FÜR ALLE VARIANTEN  
· SEGUI LE FASI 1-2 PER TUTTE LE VARIANTI

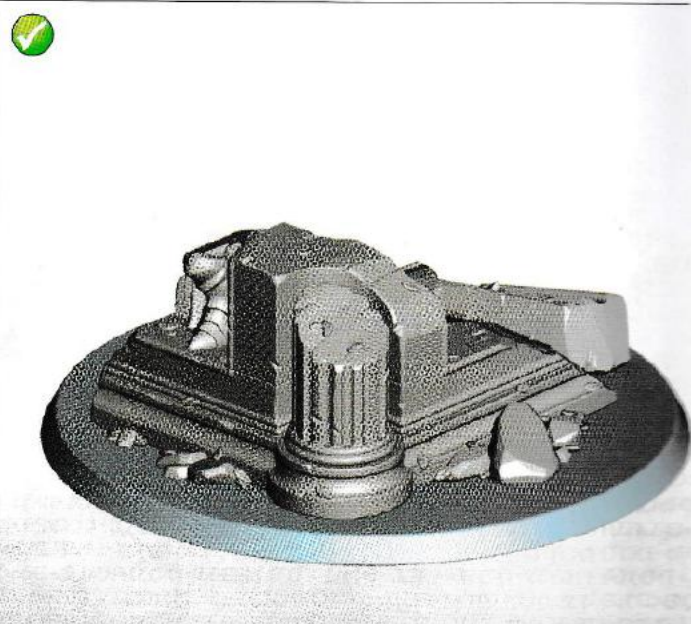
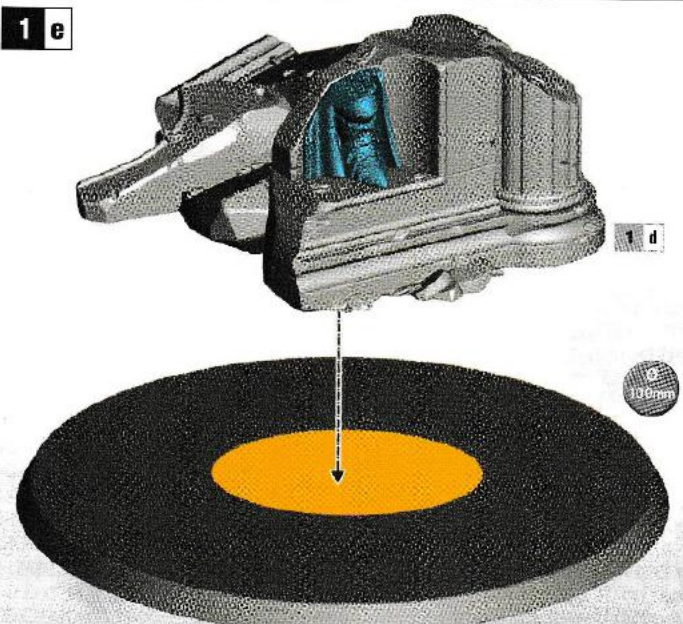
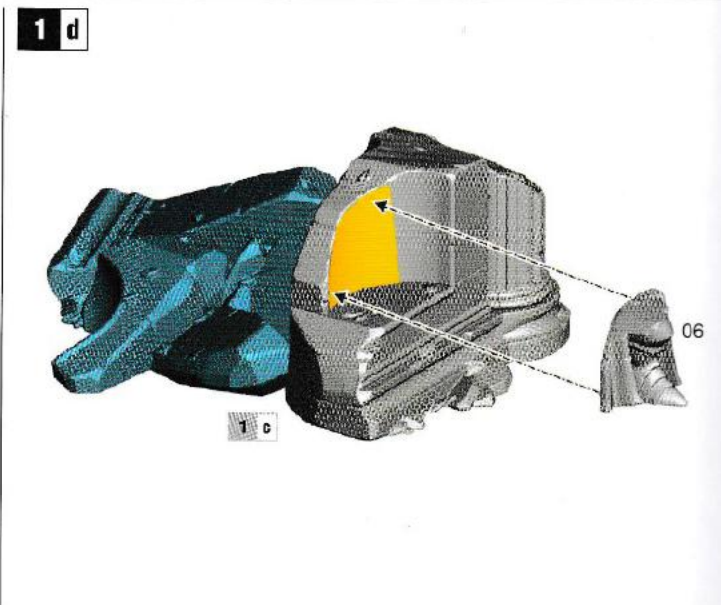
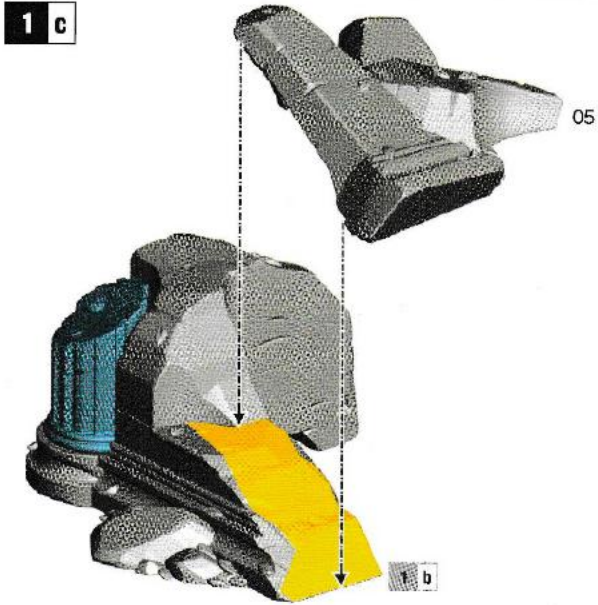
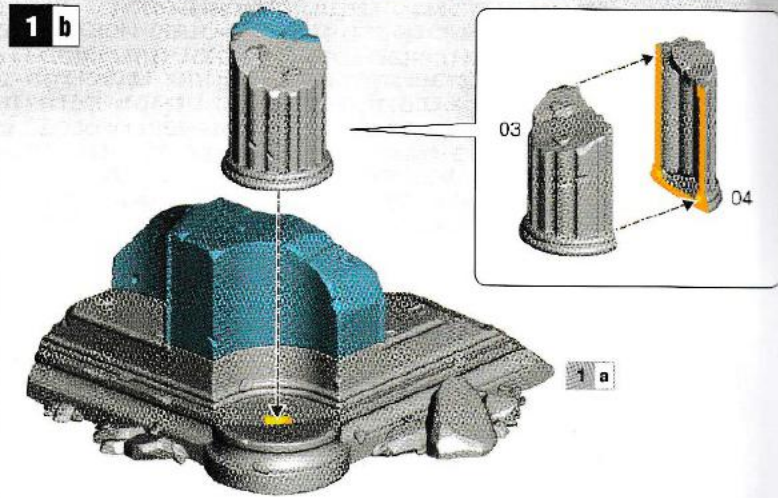
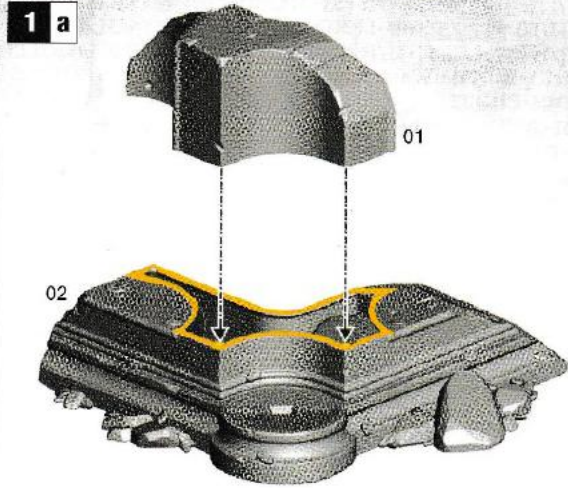

2 a

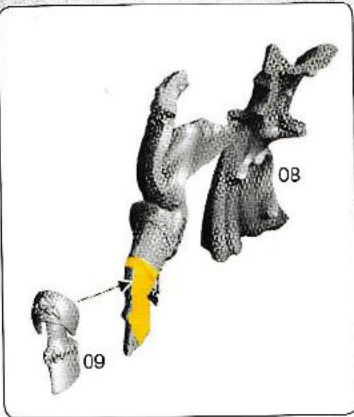

2 b

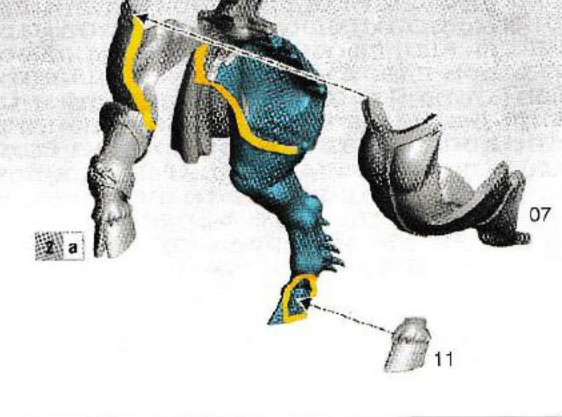

2 c

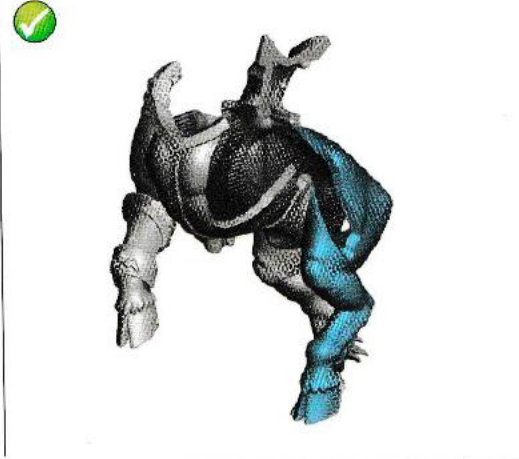
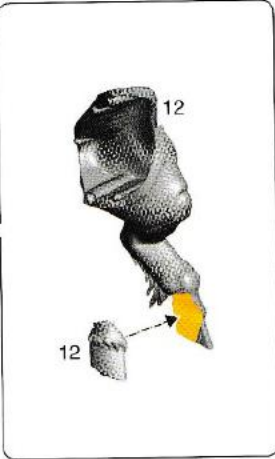
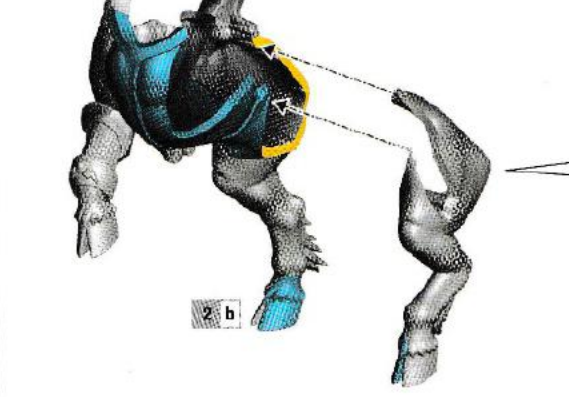

3 - 5 AVENTIS FIRESTRIKE, MAGISTER OF HAMMERHAL

3 a

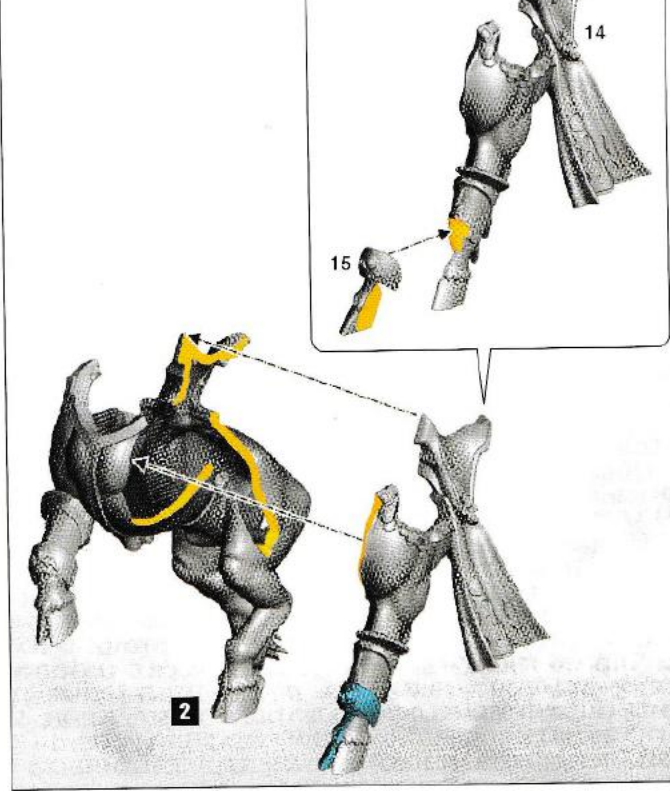

3 b

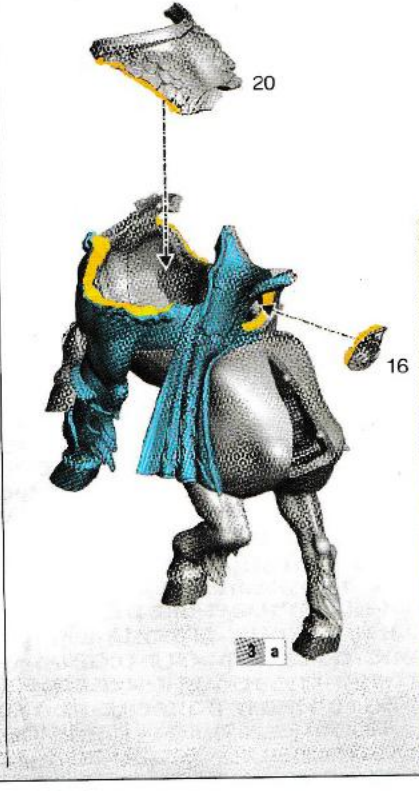

3 c

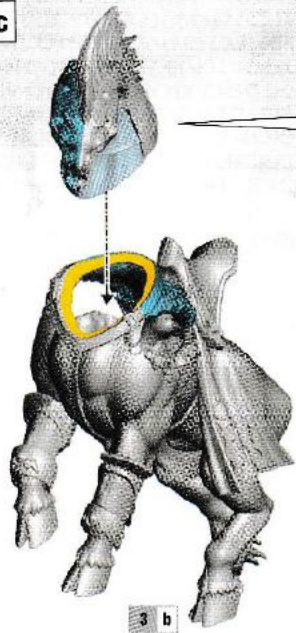

18

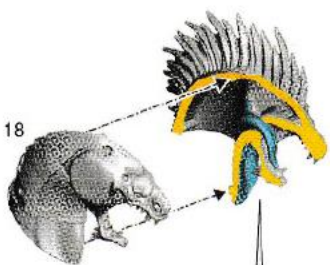

19



17

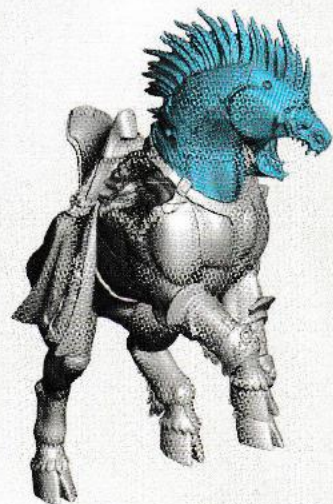

3 d

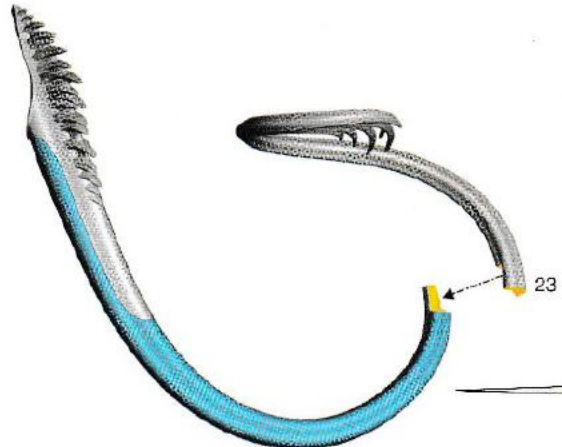

23

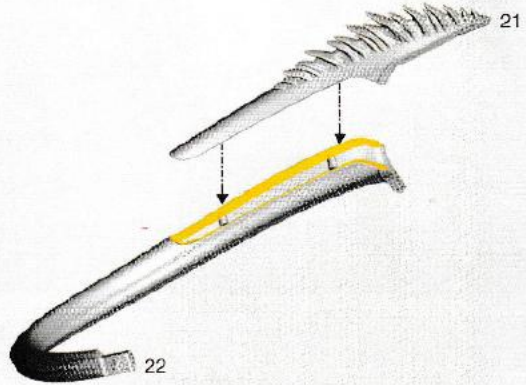

21

22

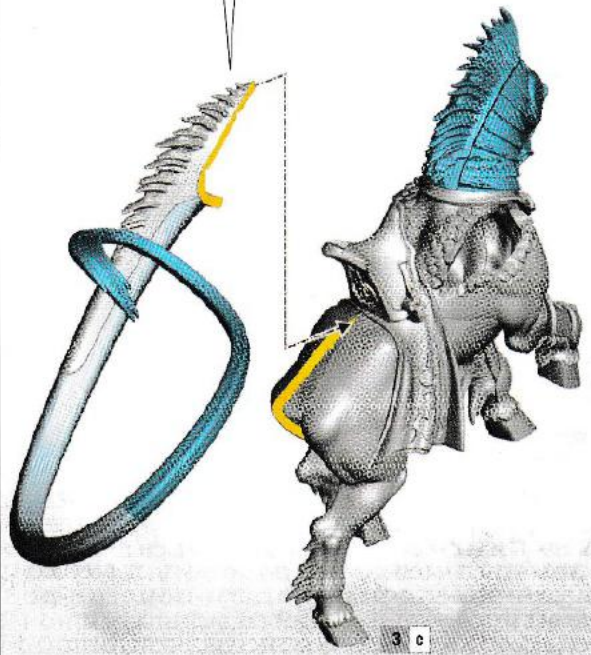

3 c



3 e

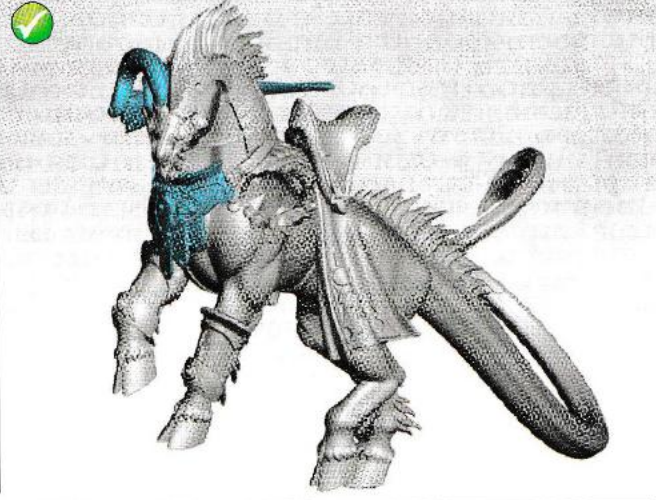
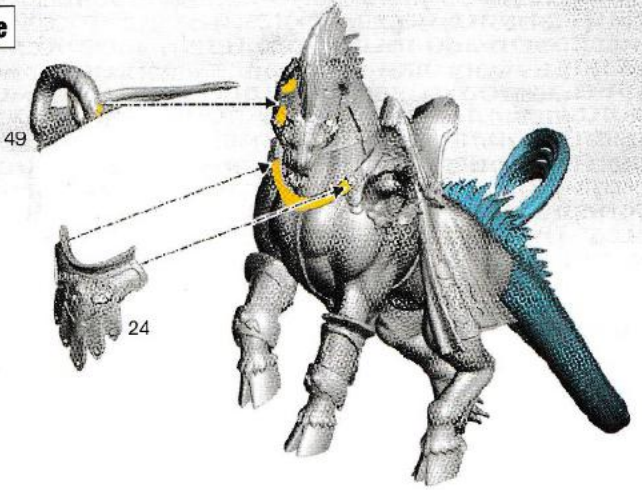

4 a

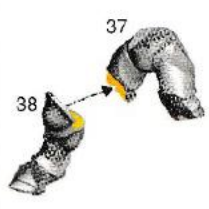

4 b

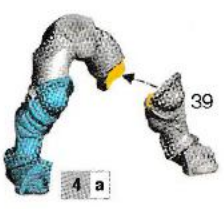

4 c

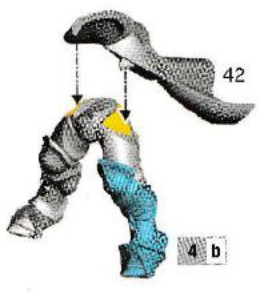

4 d

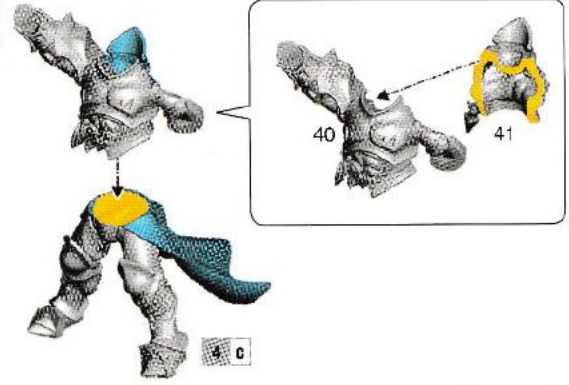

4 e

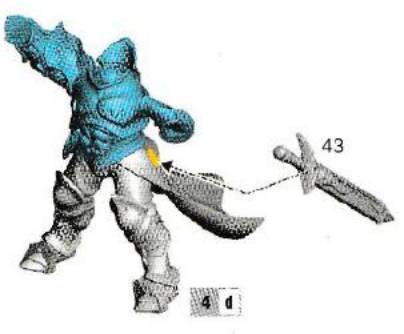

4 f



4 g



4 h

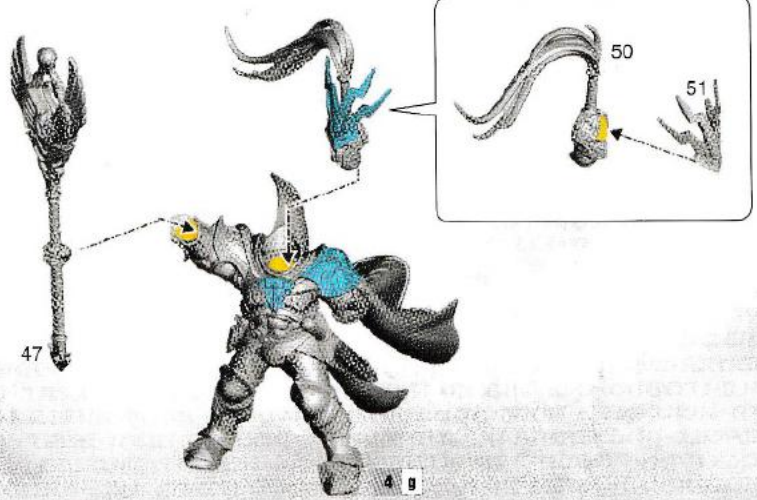



5 a

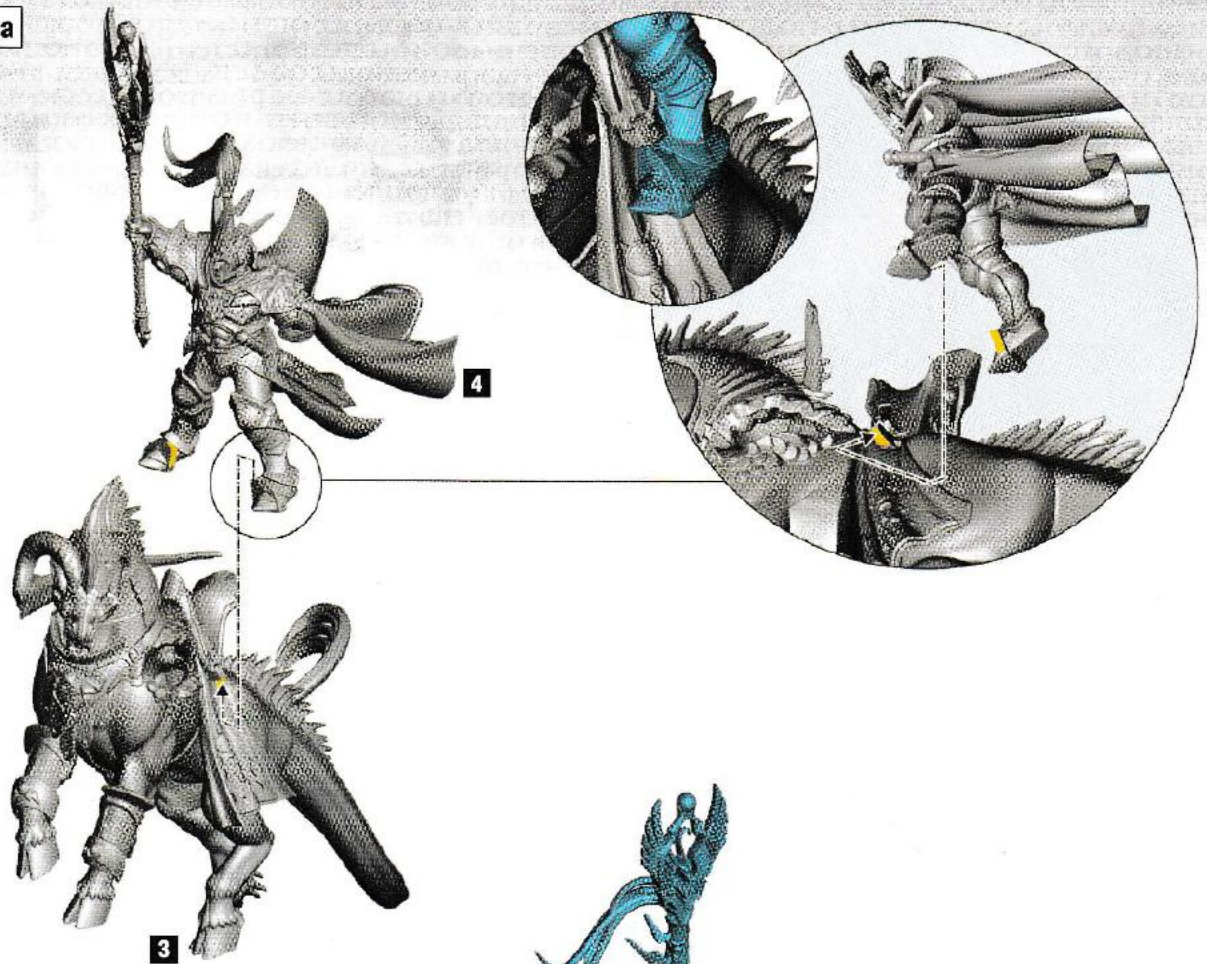

5 b



5 c



5 d

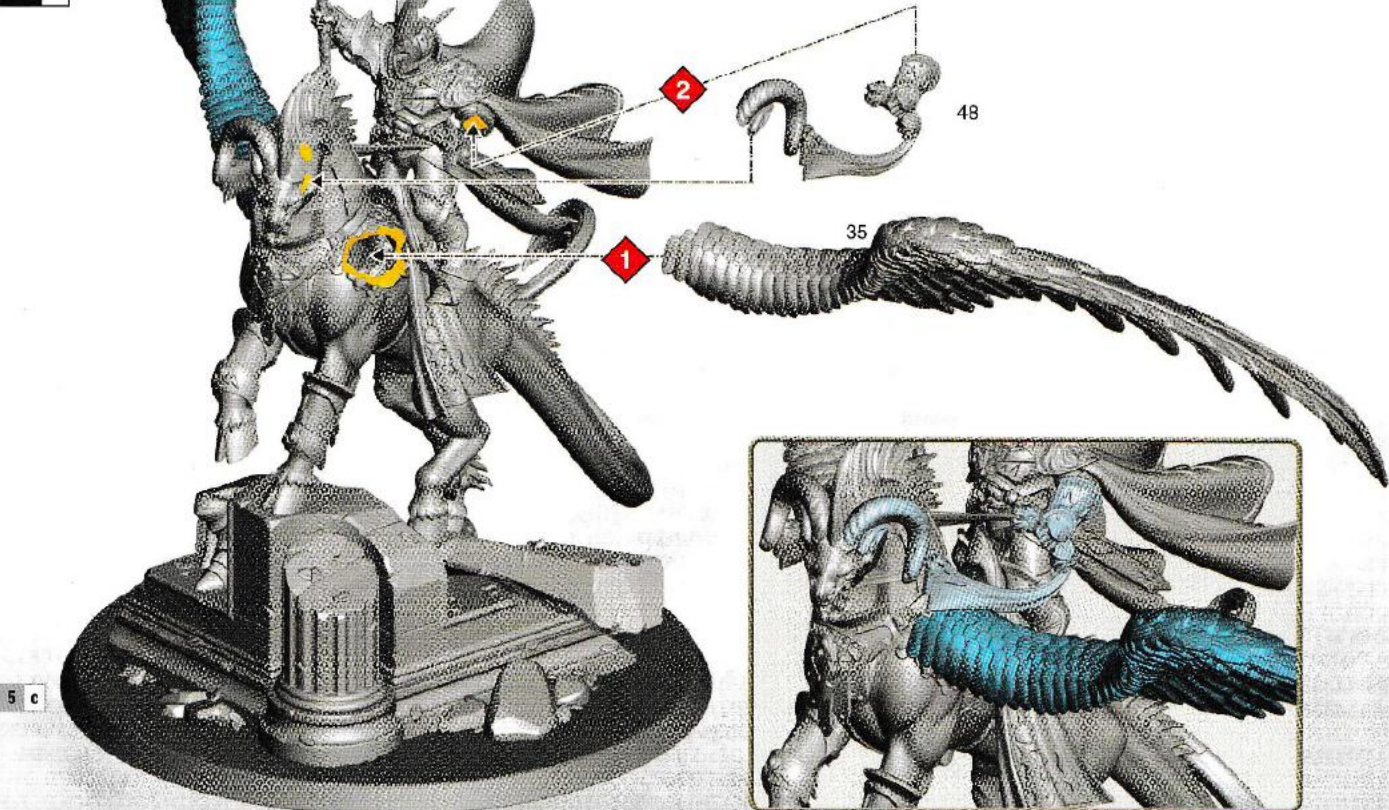



# 6 LORD-ARCANUM

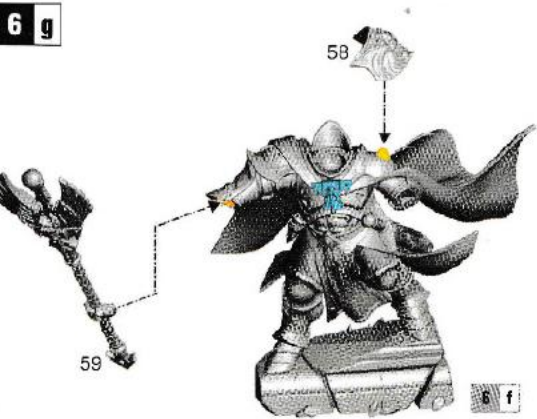
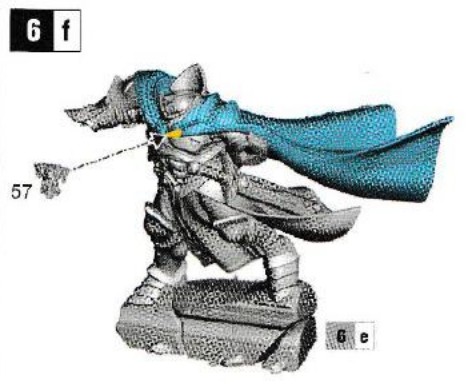
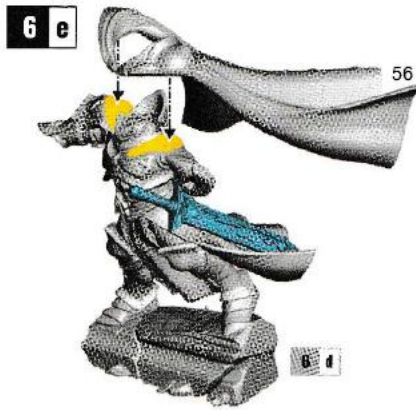
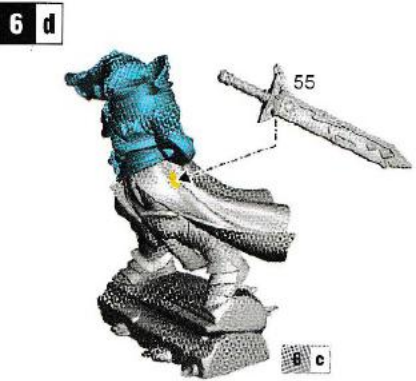
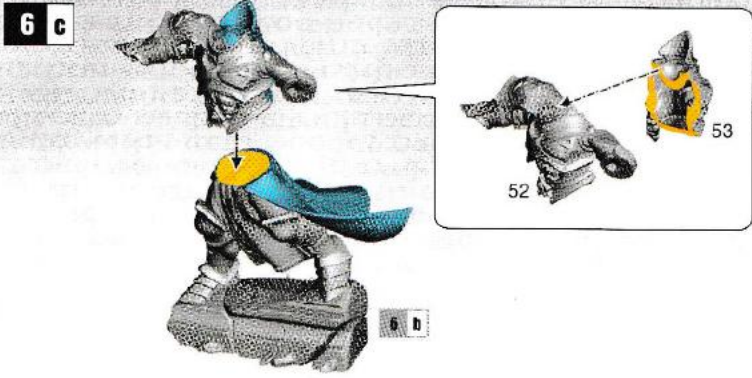
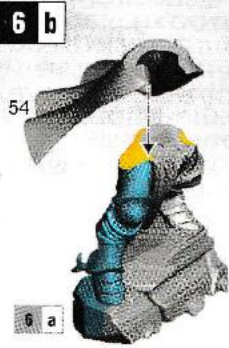
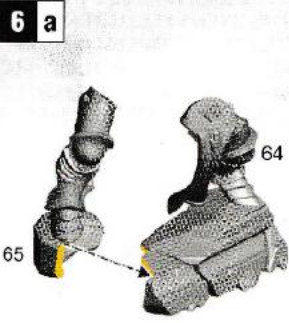

7 - 9 LORD-ARCANUM ON TAURALON

7 a

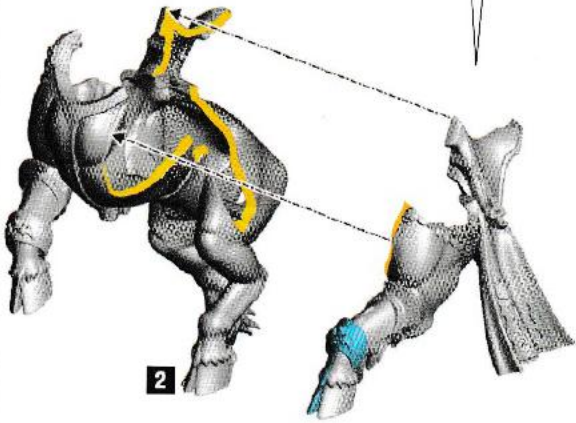
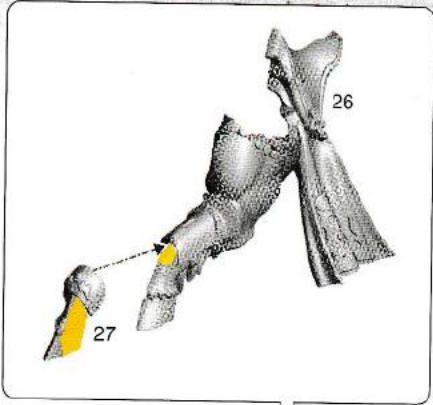

7 b

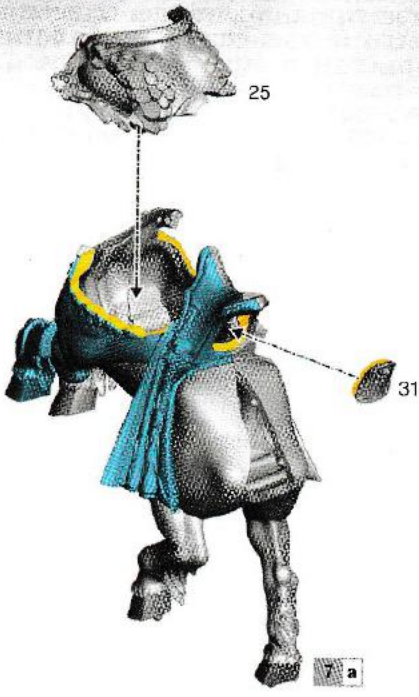

7 c

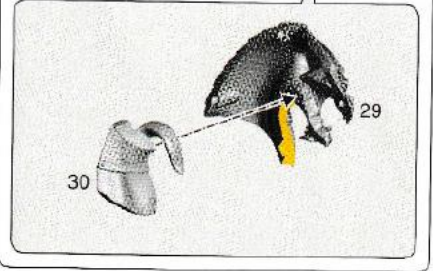
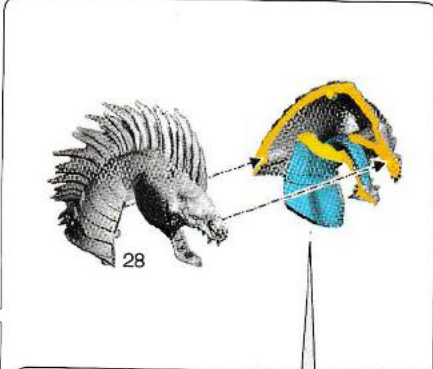
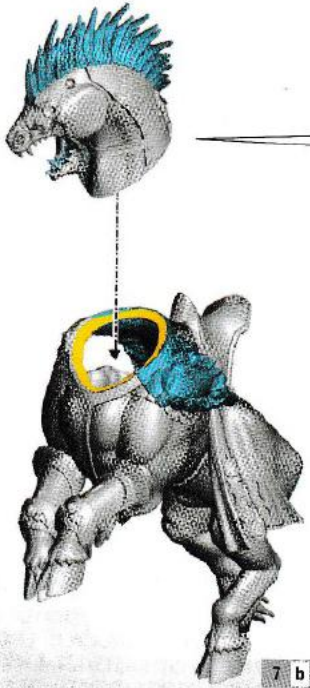

7 d

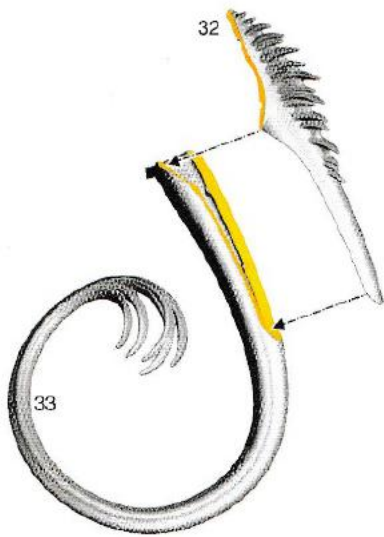

7 e

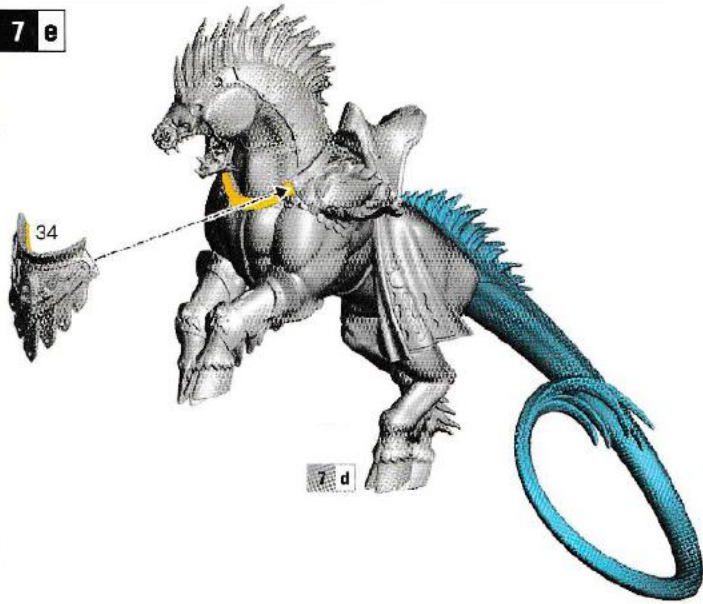

7 f

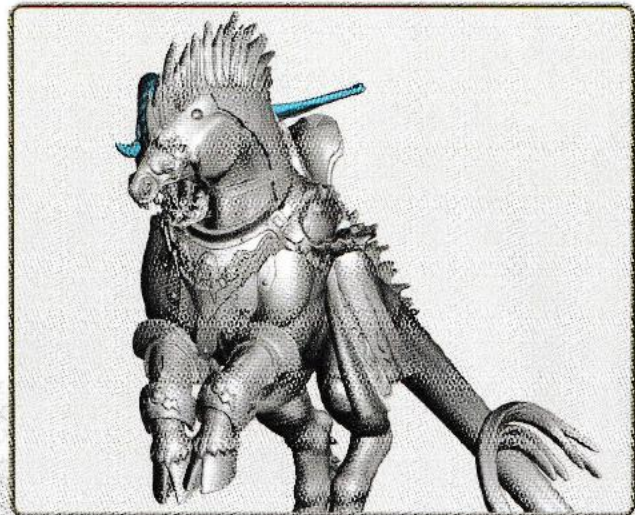
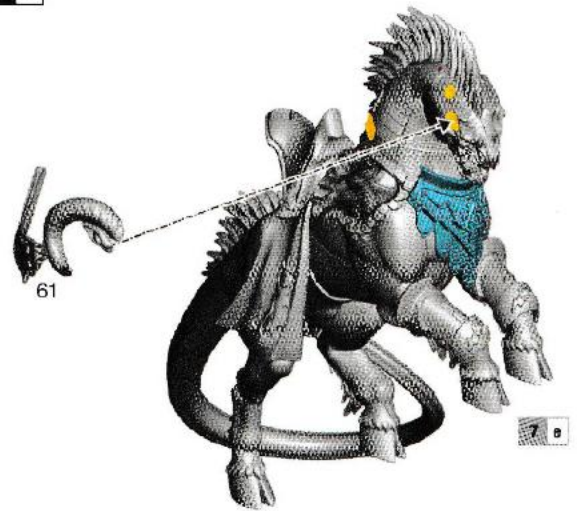

8 a

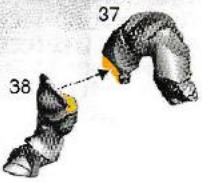

8 b

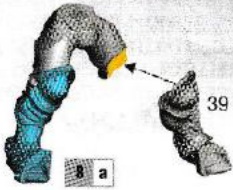

8 c

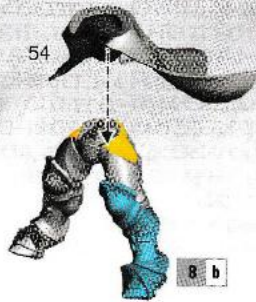

8 d

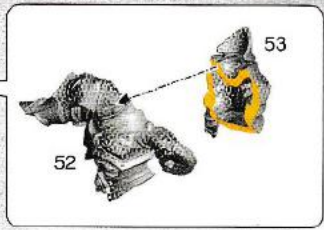
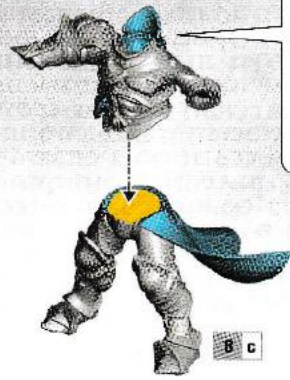

8 e

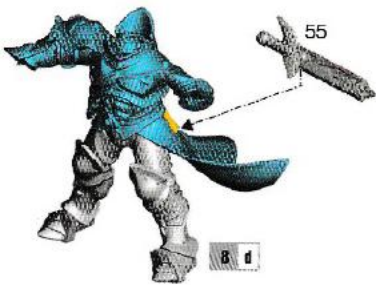

8 f

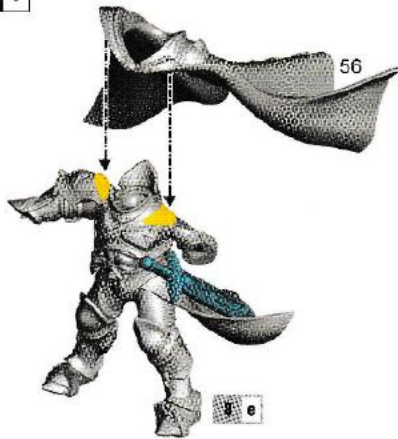

8 g



8 h

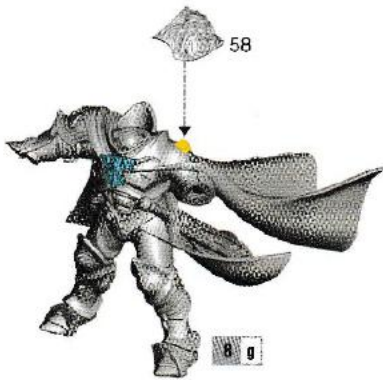

8 i

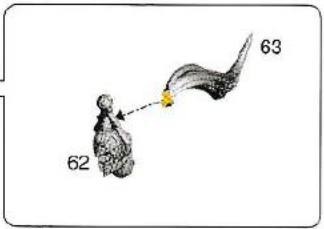
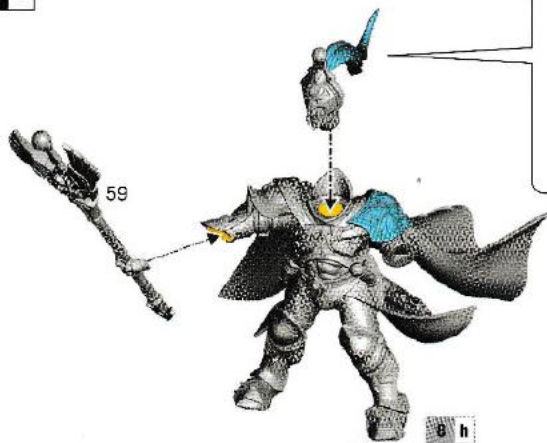

9 a

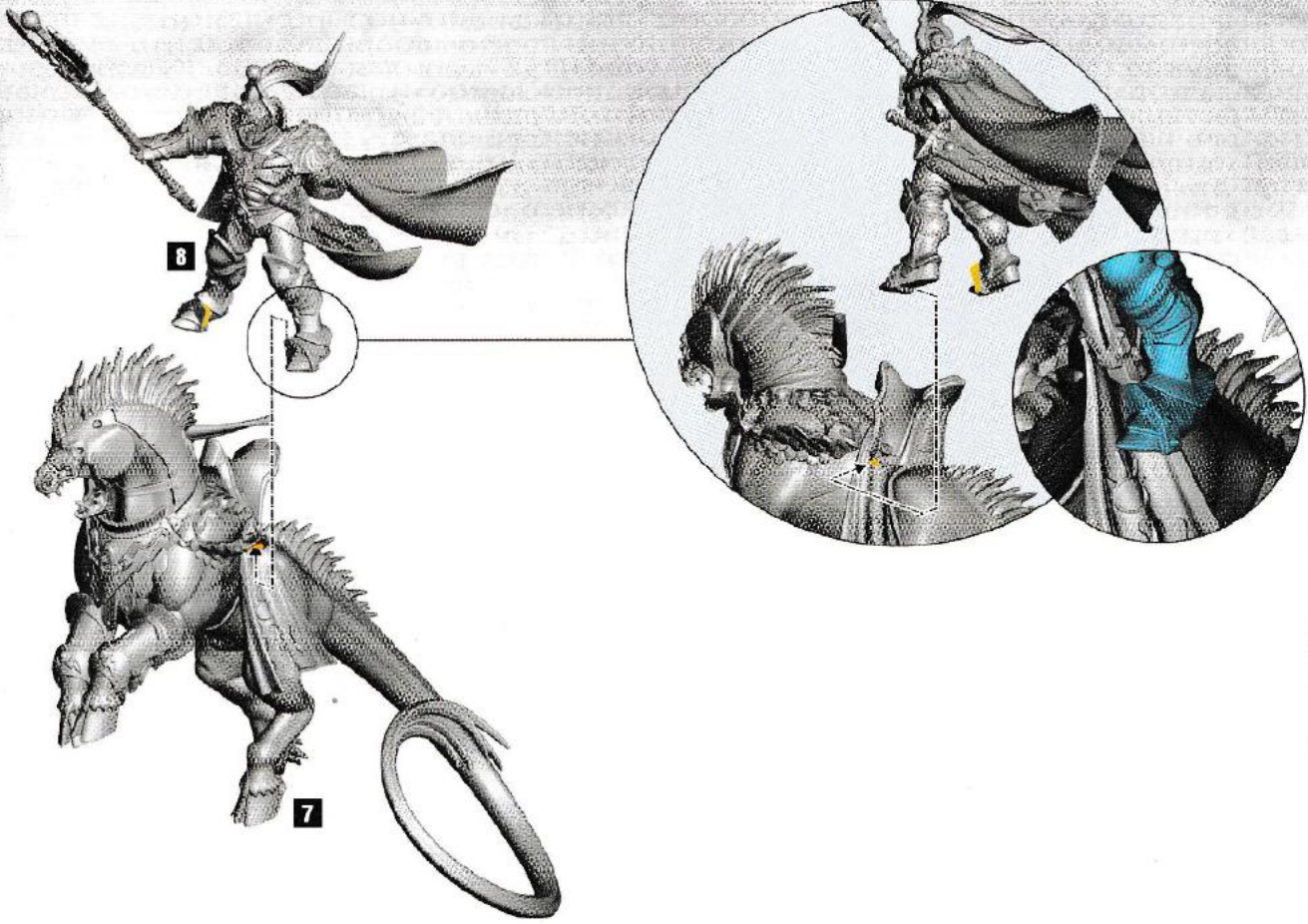

9 b





9 c



9 b

9 d



60

35

9 c

