

Free Downloads of Build Instructions,
Assembly Booklets & How To Guides

BuildInstructions.com

LOGAN GRIMNAR ON STORMRIDER

STEPS
 ETAPES
 PASOS
 SCHRITTE
 FASI
 ステップ

1 - 5

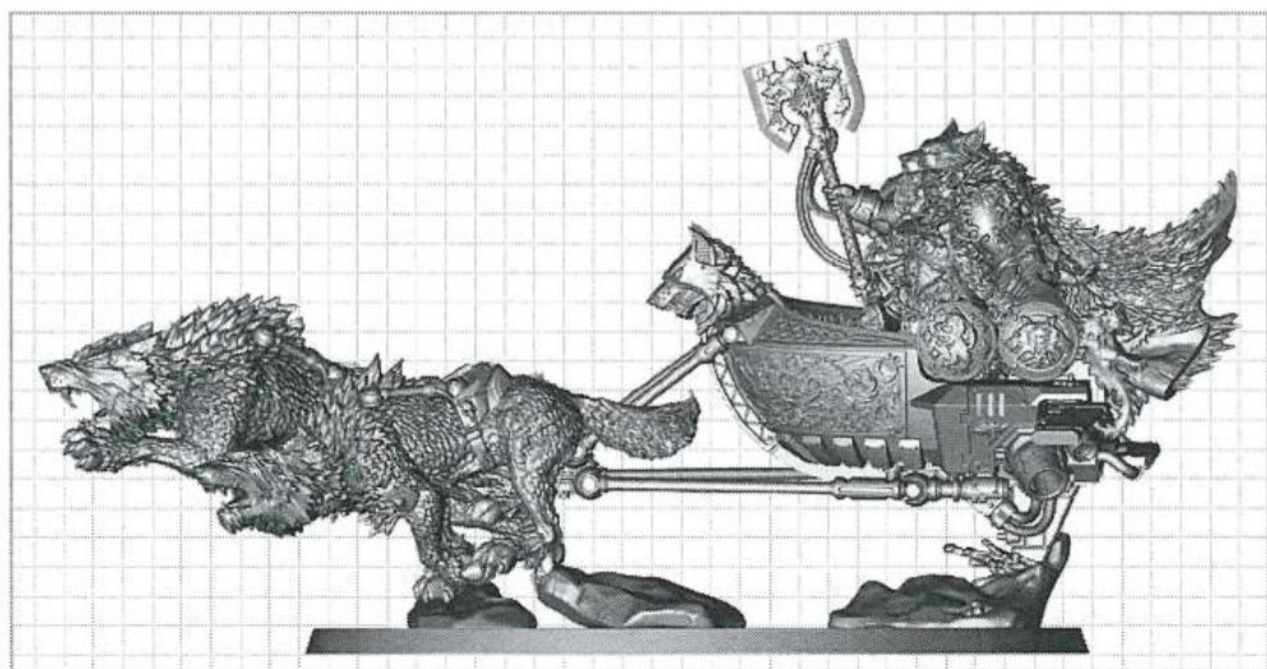

	WS	BS	S	T	W	I	A	Ld	Sv	Unit Type	Unit Composition
Logan Grimnar	6	5	4	4	4	5	5	10	2+	Infantry (Character)	1 (Unique)
			┌ Armour ─┐								
		BS	F	S	R	HP				Unit Type	
Stormrider		3	12	12	12	3				Vehicle (Chariot, Open-topped)	

EXPLANATION OF SYMBOLS • EXPLICATION DES SYMBOLES • EXPLICACIÓN DE SÍMBOLOS
ERLÄUTERUNG DER SYMBOLE • LEGENDA DEI SIMBOLI • アイコンの説明 • 符号説明



SPECIAL INSTRUCTION - PLEASE READ
INSTRUCTIONS SPÉCIALES - LIRE ATTENTIVEMENT
INSTRUCCIÓN ESPECIAL - POR FAVOR, LÉALA
BESONDERE ANWEISUNG - BITTE LESEN
ISTRUZIONI SPECIALI - LEGGI ATTENTAMENTE
特記事項 - 必ず読んでください
特殊説明 - 請細読



STAGE COMPLETE
ÉTAPE TERMINÉE
PASO COMPLETADO
SCHRITT ABGESCHLOSSEN
FASE COMPLETA
このステップの完成例
阶段完成



CHOICE OF PARTS
CHOIX D'ÉLÉMENTS
MODELOS DE COMPONENTES
AUSWAHL AN TEILEN
SCELTA DI COMPONENTI
パーツの選択
部件选择



PAINT BEFORE ASSEMBLY
PEINDRE AVANT ASSEMBLAGE
PINTAR ANTES DEL MONTAJE
ERST BEWALDEN, DANN ZUSAMMENBAUEN
DIPINGI PRIMA DELL'ASSEMBLAGGIO
組み立て前にペイントすること
組込前請先塗装



DRY FIT STAGE BEFORE GLUING
TESTER AVANT DE COLLER
COMPROBAR EL ENCAJE ANTES DE PEGAR
POSITIONIERUNG ERST OHNE KLEBSTOFF AUSPROBIEREN
PROVA A SECCO PRIMA DI INCOLLARE
接着前に仮組みすること
涂胶前請先试装



ALTERNATE VIEW
AUTRE ANGLE DE VUE
VISTA ALTERNATIVA
ALTERNATIVE ANSICHT
VISUALE ALTERNATIVA
別の角度から見た図
其他视角



REPEAT PROCESS
RÉPÉTER L'ÉTAPE
REPETIR PASOS
VORGANG WIEDERHOLEN
RIPETI IL PROCESSO
この手順を繰り返すこと
重复过程



DO NOT GLUE THE COMPONENTS
NE PAS COLLER LES ÉLÉMENTS
NO PEGAR LOS COMPONENTES
BITTE DIE TEILE NICHT KLEBEN
NON INCOLLARE I COMPONENTI
パーツを接着しないこと
請勿粘合部件



READ THIS FIRST: Before assembling your model kit please read through the instructions in this booklet carefully. A pair of plastic cutters is required to remove the plastic components in this kit from their frame. To assemble your model you will need plastic glue. Games Workshop sells Citadel Plastic Cutters and Citadel Plastic Glue, but does not recommend these products for use by children under the age of 16 without adult supervision.



À LIRE EN PREMIER : Avant de vous lancer dans l'assemblage de ce kit, veuillez lire attentivement les instructions de ce livret. Une pince coupante pour plastique est nécessaire pour détacher chaque élément de sa grappe. Vous aurez également besoin de colle plastique. Les lignes de moulage peuvent être retirées avec un couteau de modélisme. Games Workshop commercialise des Pinces Coupantes Citadel et de la colle plastique Citadel, mais n'en recommande pas l'usage pour les enfants de moins de 16 ans sans la supervision d'un adulte.



LEER ANTES DE MONTAR: Antes de montar el contenido del kit, lee estas instrucciones cuidadosamente. Para montar este kit te harán falta unas Tenazas Citadel para separar las piezas de la matriz de plástico y también necesitarás pegamento para plástico. Games Workshop vende herramientas de modelismo y Pegamento para plástico Citadel, pero no recomienda estos productos a menores de 16 años sin la supervisión de un adulto.



LIES DIES ZUERST: Bitte lies diese Anleitung sorgfältig, bevor du mit dem Zusammenbau deiner Miniatur beginnst. Du benötigst einen Kunststoffseitenschneider, um die Kunststoffbauteile aus dem Gussrahmen herauszutrennen, und Kunststoffkleber, um die Miniatur zusammenzubauen. Games Workshop bietet Citadel-Kunststoffseitenschneider und Citadel-Kunststoffkleber an, empfiehlt aber, dass Kinder unter 16 Jahren diese nur unter Aufsicht eines Erwachsenen benutzen.



LEGGI PRIMA QUESTO: leggi attentamente queste istruzioni prima di assemblare i modelli. Per rimuovere dallo sprue i componenti di plastica di questo kit sono necessarie un paio di tronchesine. Per assemblare i modelli occorre la colla per plastica. Games Workshop vende Tronchesine Citadel e Colla per plastica Citadel, ma ne sconsiglia l'uso da parte dei minori di 16 anni senza la supervisione di un adulto.



組み立て前にお読みください: ミニチュアを組み立てる前に、この組み立て説明書をよく読んでください。このキットに含まれるプラパーツをランナーから切り出すには、ニッパーが必要です。ミニチュアを組み立てるには、プラ用セメントが必要です。ゲームズワークショップは、シタデル・ニッパーとシタデル・プラ用セメントを販売していますが、保護者の監督なしに16歳未満のお子様がこの製品の製品を使用することを推奨していません。



首先阅读: 在组装您的整套模型之前, 请仔细阅读本手册中的说明。如想将本套模型中的塑料部件从框架上剪下来, 您需要使用塑料剪钳。在组装模型时您需要塑料胶水, Games Workshop出售Citadel塑料剪钳和Citadel塑料胶水, 但建议16岁以下儿童在成人监护下使用这些产品。



CITADEL PLASTIC GLUE THICK
COLLE PLASTIQUE ÉPAISSE CITADEL
PEGAMENTO PARA PLÁSTICO ESPESO
CITADEL-KUNSTSTOFFKLEBER (DICKFLÜSSIG)
COLLA PER PLASTICA DENSA CITADEL
シタデル・プラ用セメント (濃厚タイプ)
CITADEL 塑料稠胶



CITADEL PLASTIC GLUE THIN
COLLE PLASTIQUE LIQUIDE CITADEL
PEGAMENTO PARA PLÁSTICO FLUIDO
CITADEL-KUNSTSTOFFKLEBER (DÜNNFLÜSSIG)
COLLA PER PLASTICA FLUIDA CITADEL
シタデル・プラ用セメント (流し込みタイプ)
CITADEL 塑料薄胶



CITADEL PLASTIC CUTTERS
PINCES COUPANTES POUR PLASTIQUE CITADEL
TENAZAS CITADEL
CITADEL-KUNSTSTOFFSEITENSCHNEIDER
TRONCHESINE CITADEL
シタデル・ニッパー
CITADEL 塑料剪钳

1 STORMRIDER

A

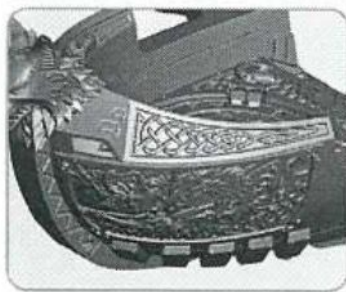
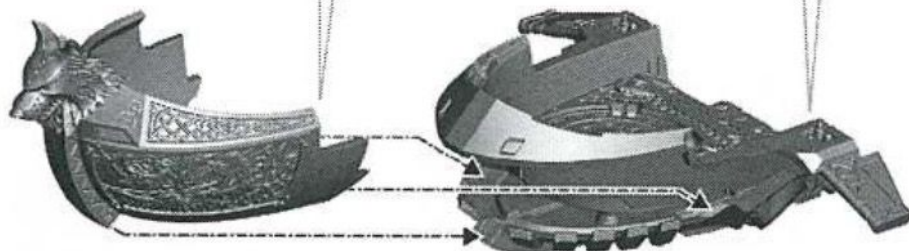
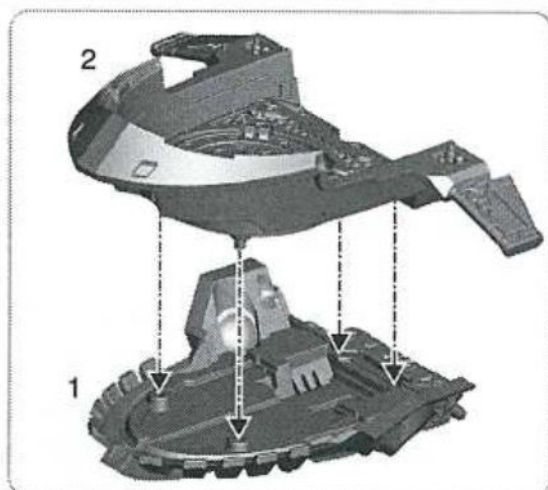
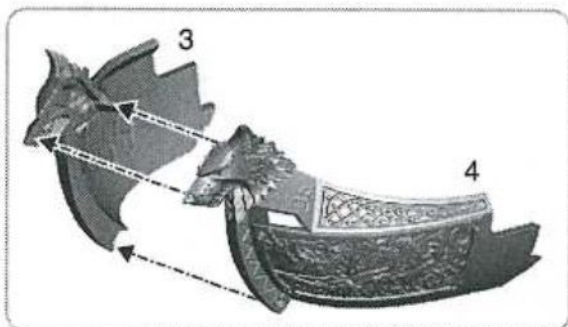

B

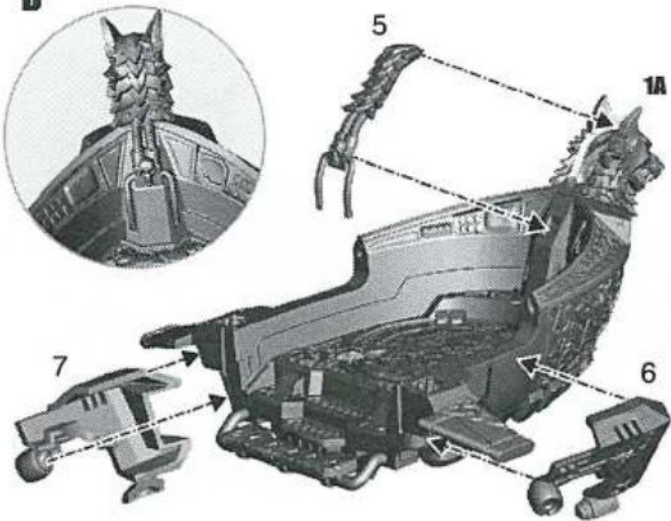

C

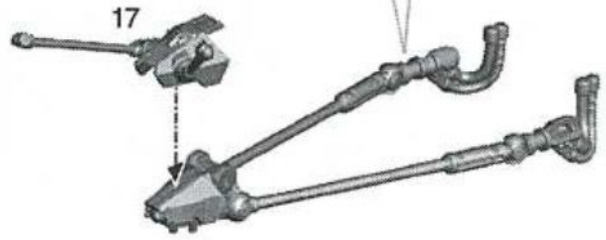
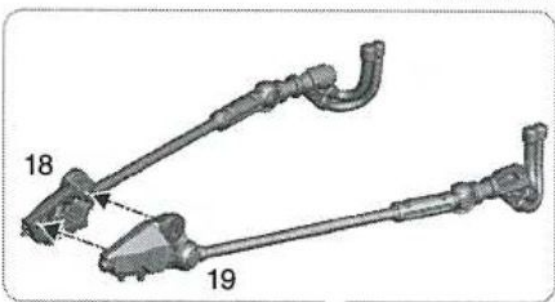

D

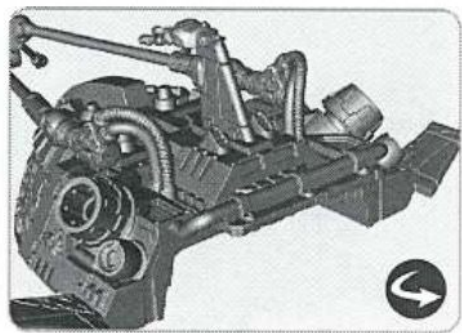
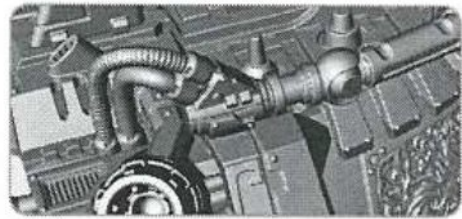
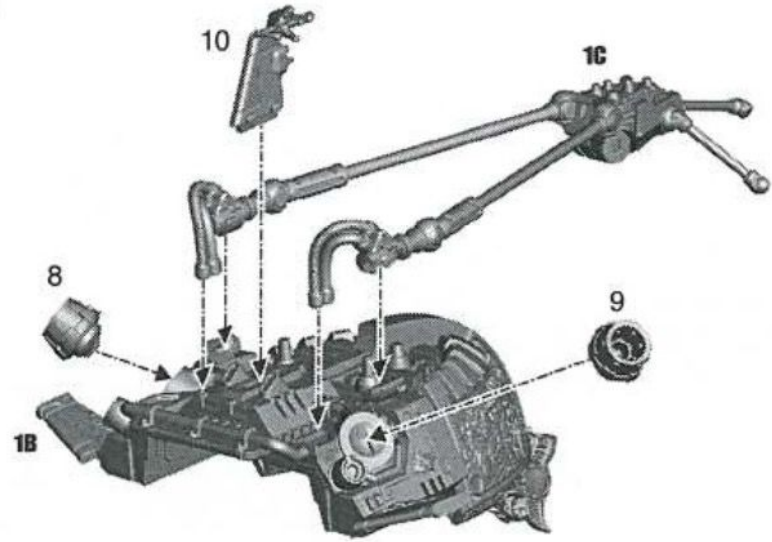

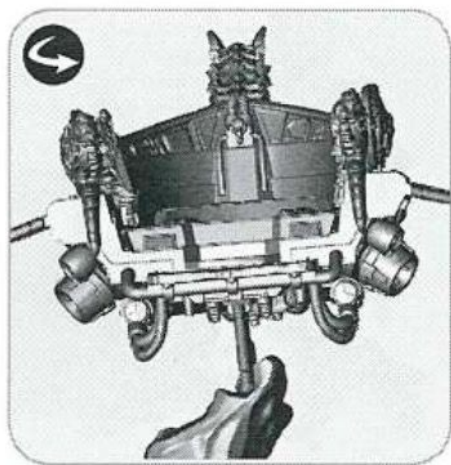
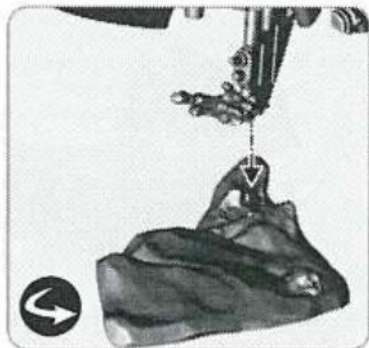
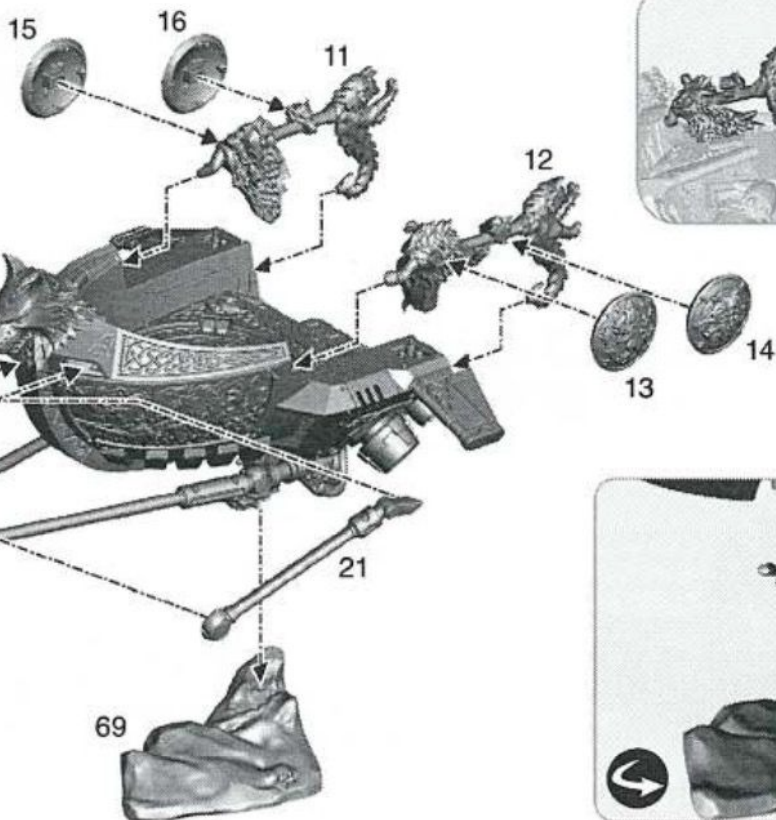
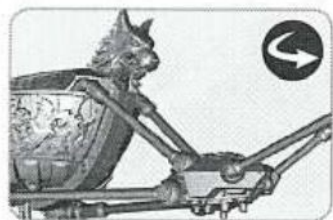
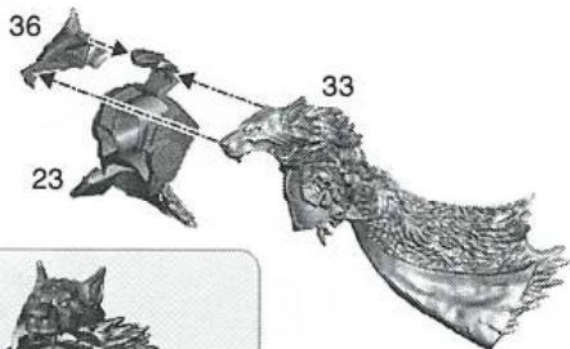
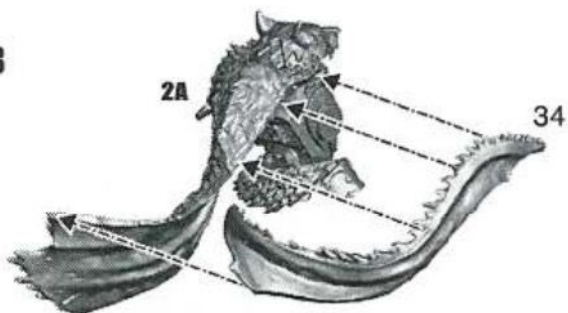
E**2****LOGAN GRIMMAR****A****B**

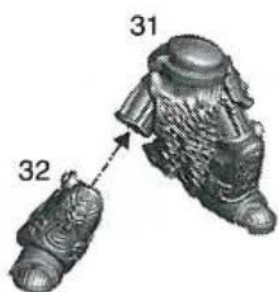
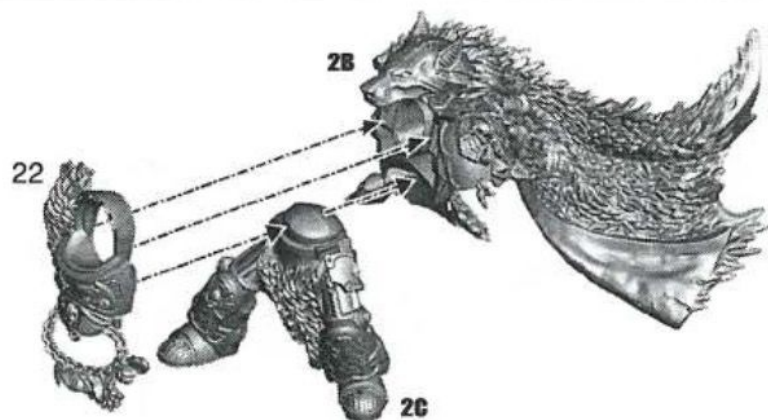
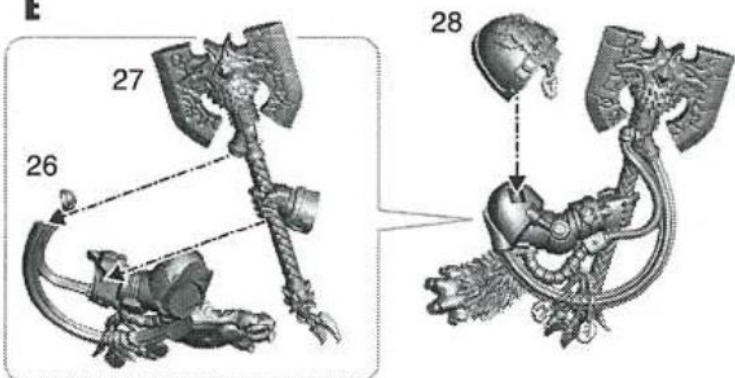
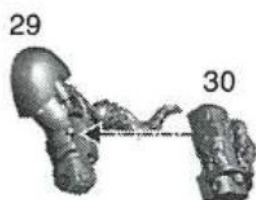
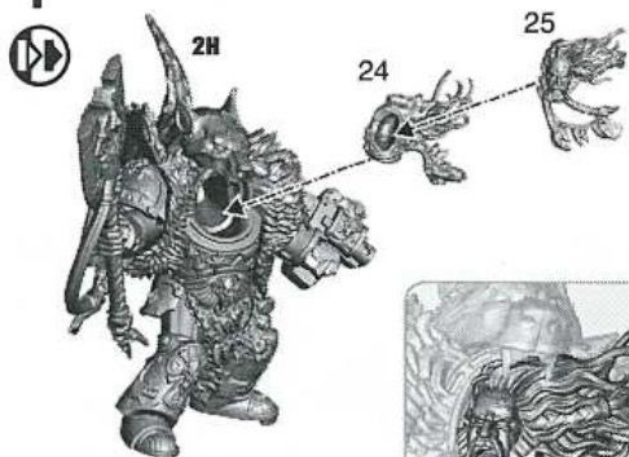
C**D****E****F****G****H****I**

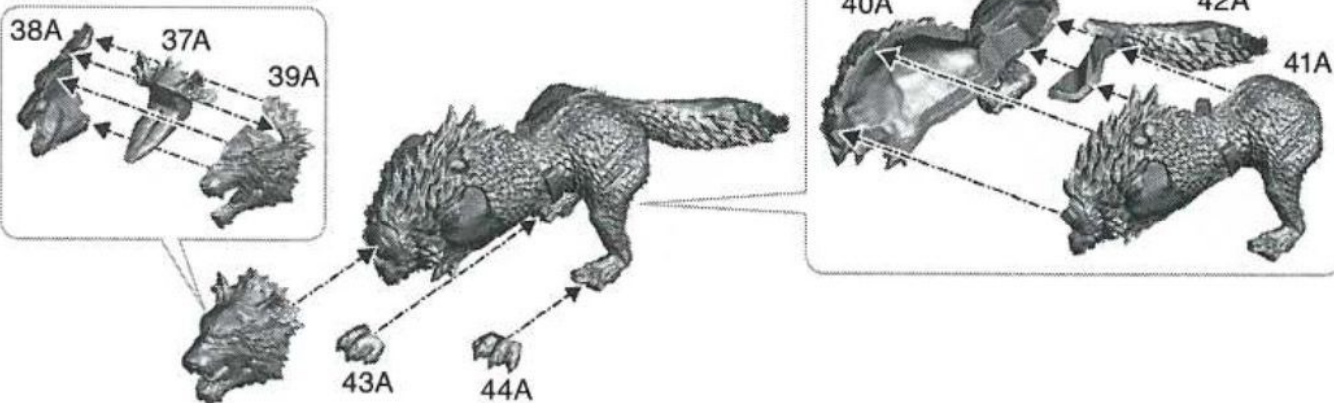
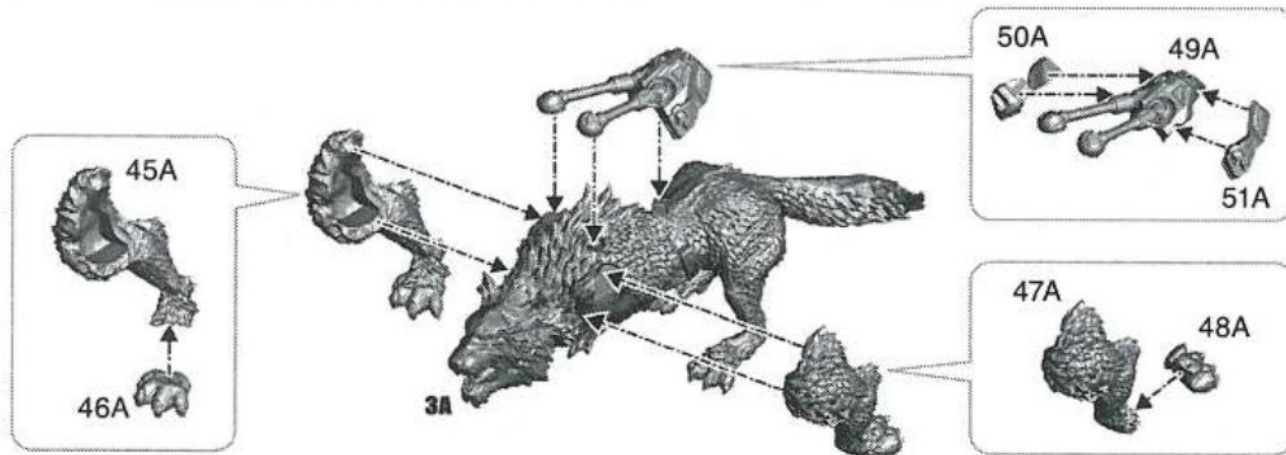
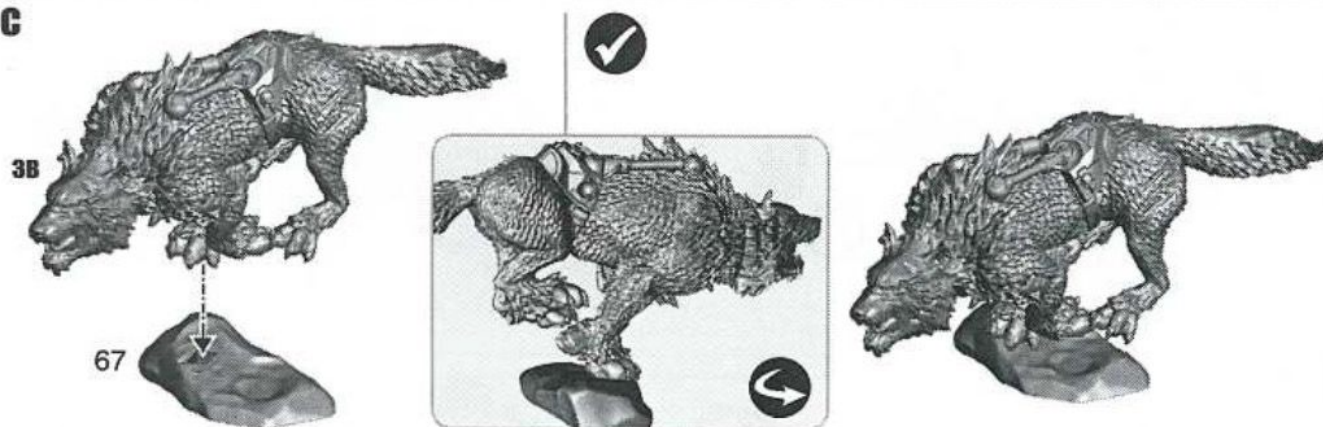
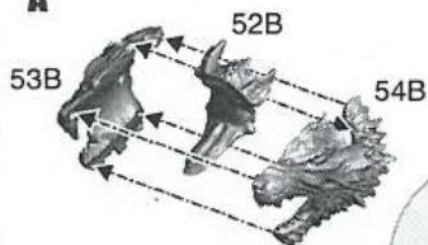
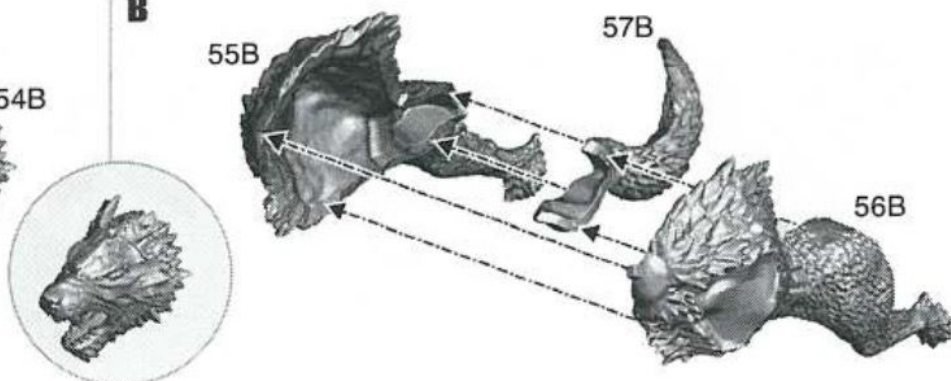
3**THUNDER WOLF, FENRIR****A****B****C****4****THUNDER WOLF, TYRNAK****A****B**

C

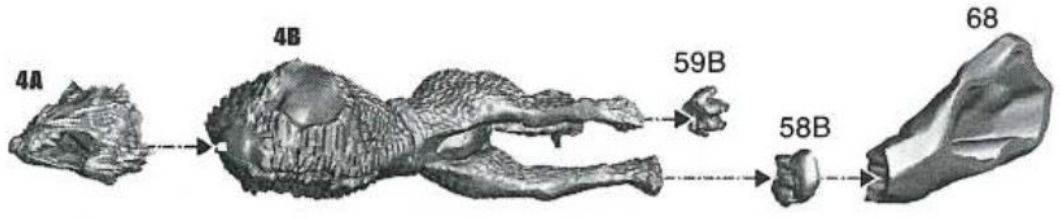

D

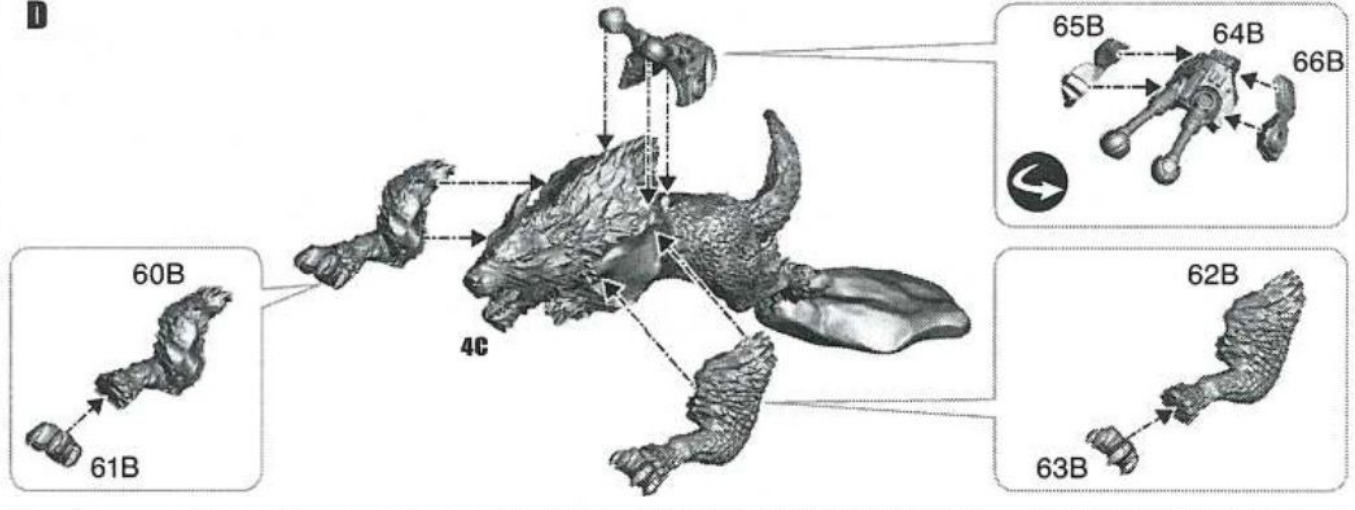

✓



↻

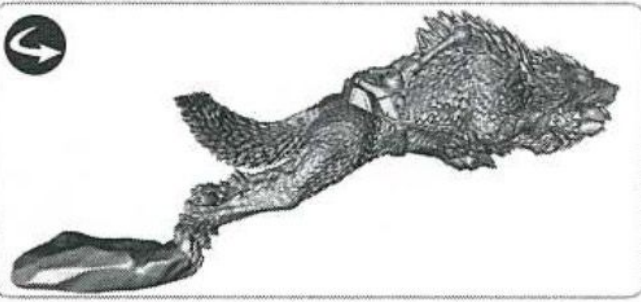

5

**FINAL ASSEMBLY • ASSEMBLAGE FINAL • MONTAJE FINAL
ABSCHLIESSENDE ZUSAMMENBAU • ASSEMBLAGGIO COMPLETO**

A

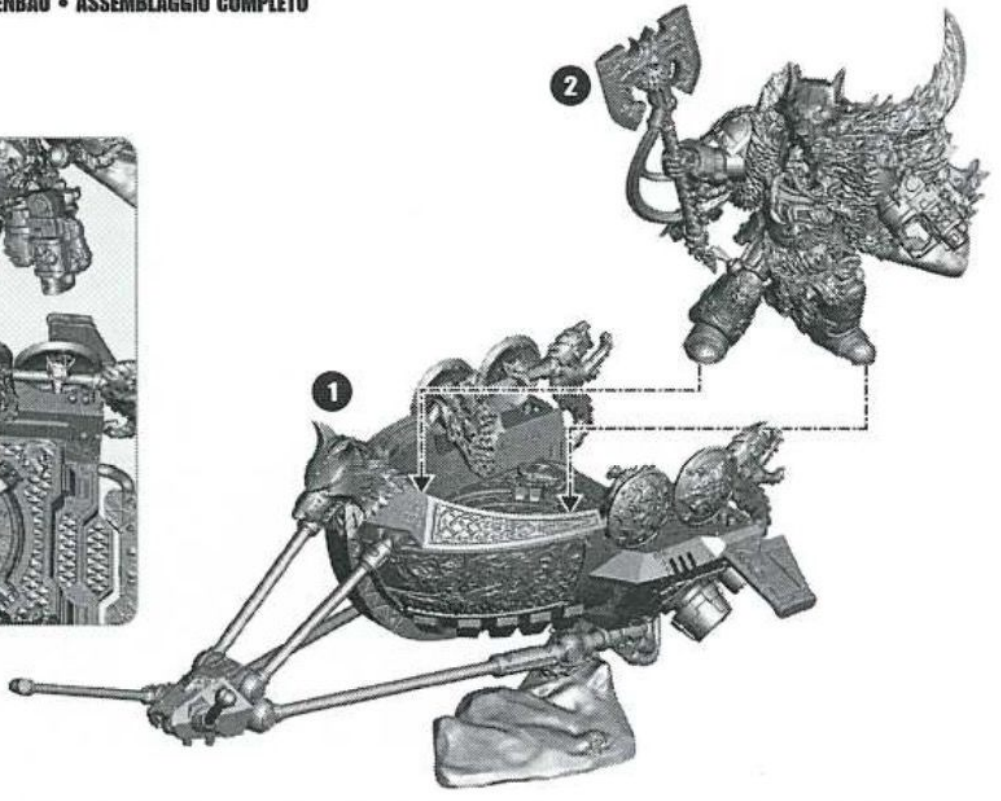
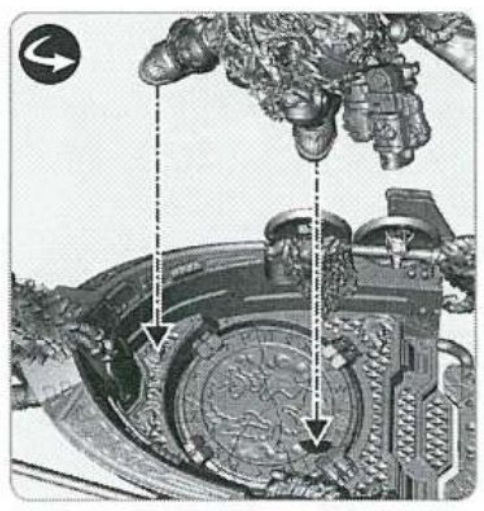

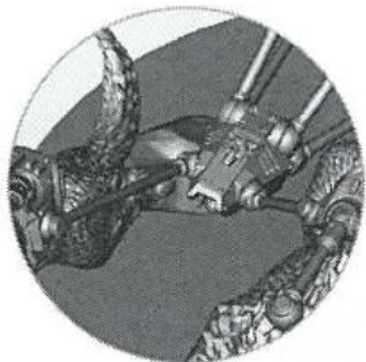
B**5A**