

Free Downloads of Build Instructions,
Assembly Booklets & How To Guides

BuildInstructions.com

WARHAMMER THE HORUS HERESY

LEGION LEVIATHAN SIEGE DREADNOUGHT WITH CLAW AND DRILL WEAPONS

! READ THIS FIRST: Before assembling your model kit, please read through the instructions in this booklet carefully. A pair of plastic cutters is required to remove the plastic components in this kit from their frame. We advise using a mouldline scraping tool to clean up the parts. To assemble your model, you will need plastic glue. Games Workshop sells Citadel Fine Detail Cutters, Citadel Mouldline Removers and Citadel Plastic Glue, but does not recommend these products for use by children under the age of 16 without adult supervision.

A LIRE EN PREMIER: Avant de vous lancer dans l'assemblage de ce kit, veuillez lire attentivement les instructions de ce livret. Une pince coupante est requise pour détacher chaque élément de sa grappe. Nous vous recommandons l'utilisation d'un grattoir pour ébarber les éléments. Pour l'assemblage, vous aurez également besoin de colle plastique. Games Workshop commercialise les Pinces de Précision Citadel, l'Ébarboir Citadel et la Colle Plastique Citadel, mais n'en recommande pas l'utilisation pour des enfants de moins de 16 ans sans la supervision d'un adulte.

LEER ANTES DE MONTAR: Antes de montar el contenido de este kit, lee estas instrucciones cuidadosamente. Te harán falta unas tenazas para plástico a fin de separar las piezas de la matriz. También aconsejamos una herramienta para rebabas a fin de limpiar cada pieza. Para montar la miniatura necesitarás pegamento para plástico. Games Workshop vende Tenazas Citadel, Herramientas para rebabas Citadel y Pegamento para plástico Citadel, pero no recomienda estos productos a menores de 16 años sin la supervisión de un adulto.

LIES DIES ZUERST: Bitte lies diese Anleitung sorgfältig, bevor du mit dem Zusammenbau deines Modells beginnst. Du benötigst eine Kunststoffscheitelschneider, um die Kunststoffbauteile aus dem Gussrahmen herauszutrennen, und Kunststoffscheitelschneider, um die Miniatur zusammenzubauen. Außerdem empfehlen wir, die Bauteile vorher mit einem Gussgratentferner zu säubern. Games Workshop bietet Präzisions-Kunststoffscheitelschneider von Citadel sowie Citadel-Kunststoffscheitelschneider an, empfiehlt aber, dass Kinder unter 16 Jahren diese nur unter Aufsicht eines Erwachsenen benutzen.

LEGGI PRIMA QUESTO: prima di assemblare il tuo modello, leggi le istruzioni di questo libretto con attenzione. Sono necessarie un paio di tronchesine per plastica per staccare i componenti dal loro sprue. Consigliamo di usare un attrezzo apposito per pulire i componenti. Per assemblare il modello avrai bisogno di colla per plastica. Games Workshop vende Tronchesine di precisione Citadel, Attrezzo per ripulire Citadel e Colla per plastica Citadel, ma non consiglia questi prodotti ad un pubblico minore di 16 anni senza la supervisione di un adulto.

优先阅读: 组装模型前, 请先仔细阅读本手册中的说明。需要用模型剪钳将塑料部件从板件上剪下。我们推荐使用合模线清理工具来清理零件。用塑料粘胶来组装模型。Games Workshop 销售 Citadel 精密剪钳、Citadel 合模线刮刀和 Citadel 塑料粘胶, 但不建议未满 16 岁的儿童在没有成人的监护下使用此类产品。

最初にお読みください: ミニチュアを組み立てる前に、この冊子の説明をよくお読みください。本セット内フレームからプラスチックパーツを切り取るためにプラスチック用ニッパーが必要となります。その後パーツを磨らかにするため、モールドラインを削るためのツールの使用を推奨します。モデルの組み立てには、プラスチック接着剤が必要となります。ゲームズワークショップでは「シタデルファインディテールニッパー」「シタデルモールドラインリムーバー」「シタデルプラスチック接着剤」を販売していますが、これらは保護者の監督なしでの16歳以下のお子様の使用を推奨しません。

16+



Citadel Plastic Glue
Colle plastique liquide Citadel
Pegamento para plástico fluido
Citadel-Kunststoffkleber
Colla per plastica fluida Citadel
Citadel 塑料灌缝粘胶
シタデルプラスチック接着剤流し込みタイプ



Citadel Fine Detail Cutters
Pinces de précision Citadel
Tenazas Citadel
Citadel-Seitenschneider
Tronchesine di precisione Citadel
Citadel 精密剪钳
シタデルファインディテールニッパー



Citadel Mouldline Remover
Ébarboir Citadel
Herramienta para rebabas Citadel
Gussgratentferner
Attrezzo per ripulire Citadel
Citadel 合模线刮刀
シタデルモールドラインリムーバー

EXPLANATION OF SYMBOLS - EXPLICATION DES SYMBOLES - EXPLICACIÓN DE SIMBOLOS - ERLÄUTERUNG DER SYMBOLE - LEGENDA DEI SIMBOLI - 符号说明 - 記号の説明



Repeat process
Répéter l'étape
Repetir pasos
Vorgang wiederholen
Ripeti il processo
重复步骤
プロセスを繰り返す



Rotate part
Faire pivoter
Girar la pieza
Teil drehen
Ruota il componente
旋转部件
向きを変更



Detail view
Vue détaillée
Vista detallada
Alternative Ansicht
Visuale del dettaglio
局部放大视图
拡大



Stage complete
Étape terminée
Paso completado
Schritt abgeschlossen
Fase completa
部件组装完成
完了



Choice of parts
Choix d'éléments
Modelos de componentes
Auswahl an Teilen
Scelta di componenti
零件选择
パーツ選択



Variant assembly
Variante d'assemblage
Variante de montage
Bauvariante
Assemblaggio alternativo
多种组装方案
組み立てのバリエーション



Painting sub-assembly (optional)
Peinture de sous-ensemble (optionnelle)
Submontaje de pintura (opcional)
Baugruppen zur Bemalung (optional)
Sottoassemblaggio (opzionale)
涂装后再组装 (可选)
組み立て前の塗装推奨



Dry fit stage before gluing
Tester avant de coller
Comprobar el encaje antes de pegar
Positionierung erst ohne Klebstoff ausprobieren
Prova a secco prima di incollare
使用胶水粘接前进行假组
接着前に組み合わせる

LEGION LEVIATHAN DREADNOUGHT

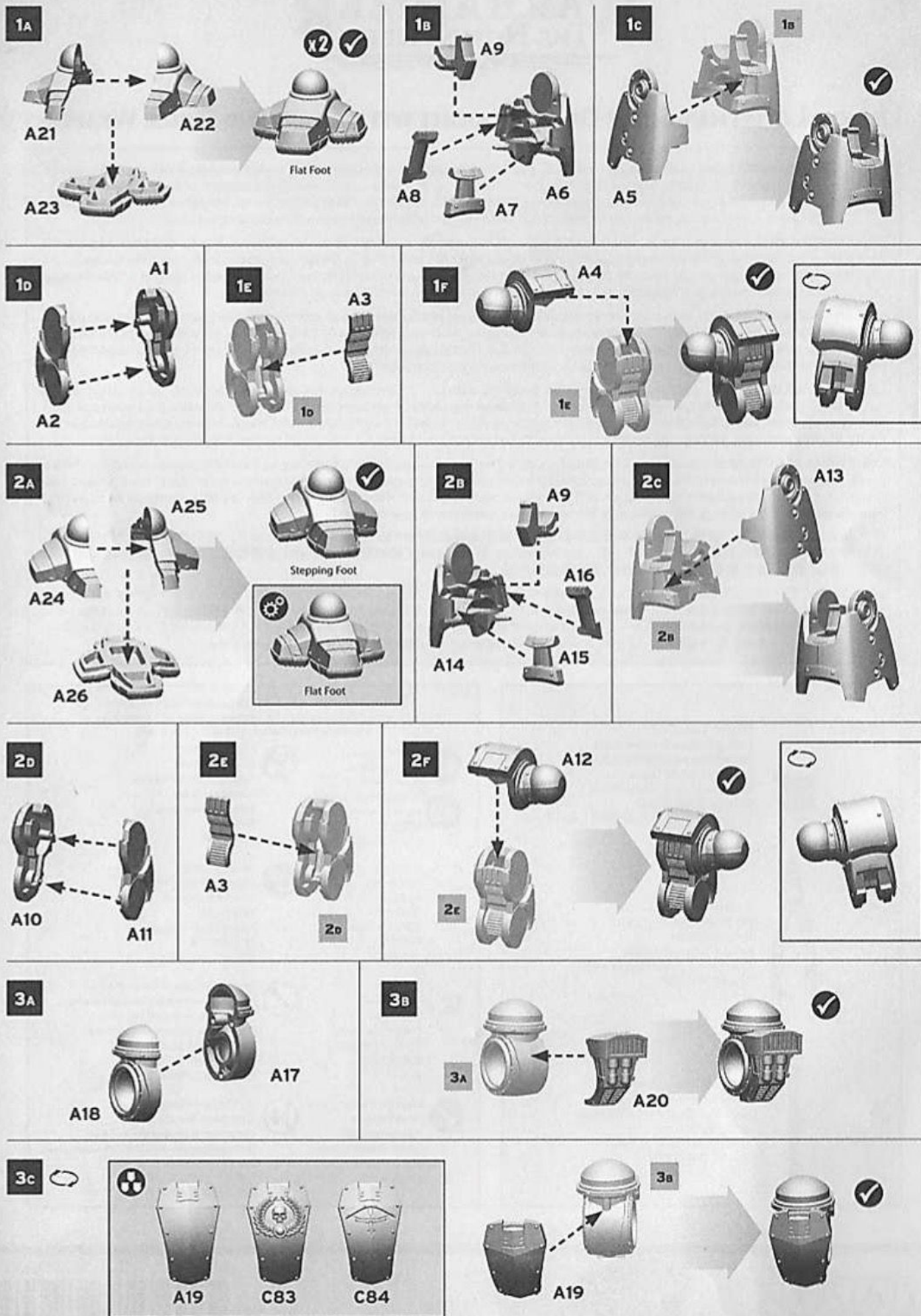

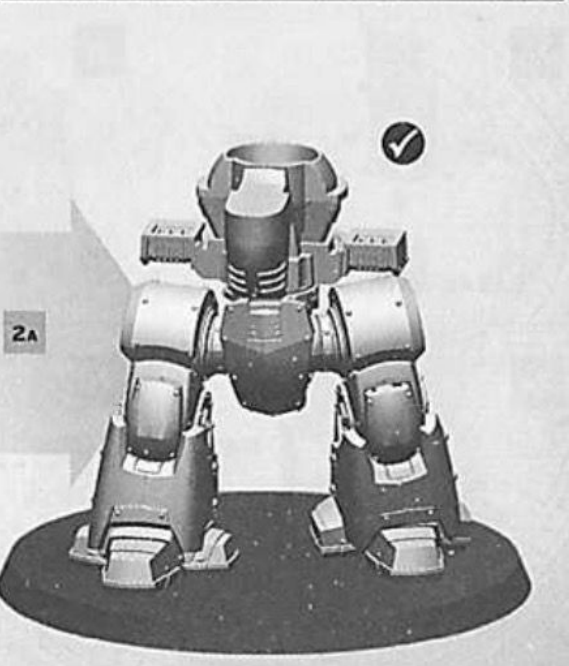
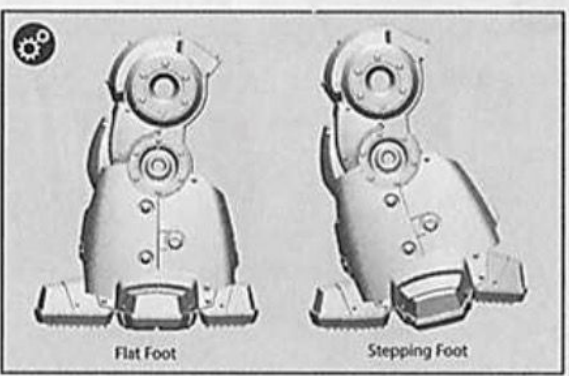
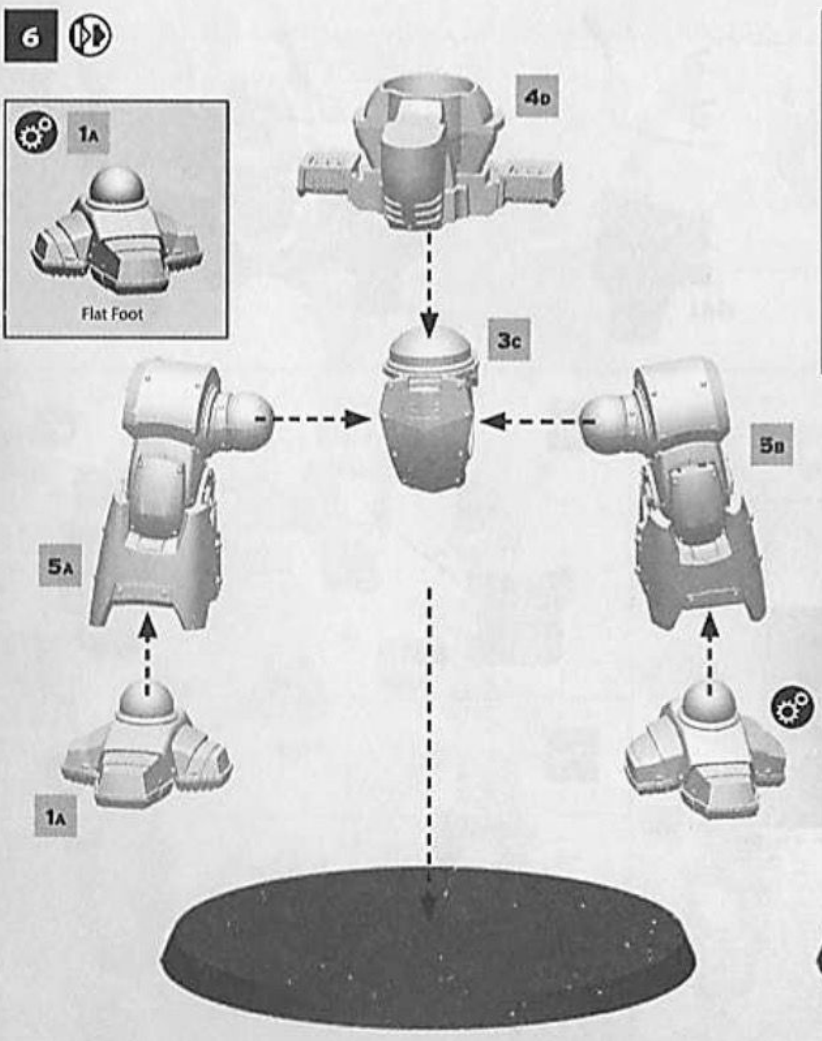
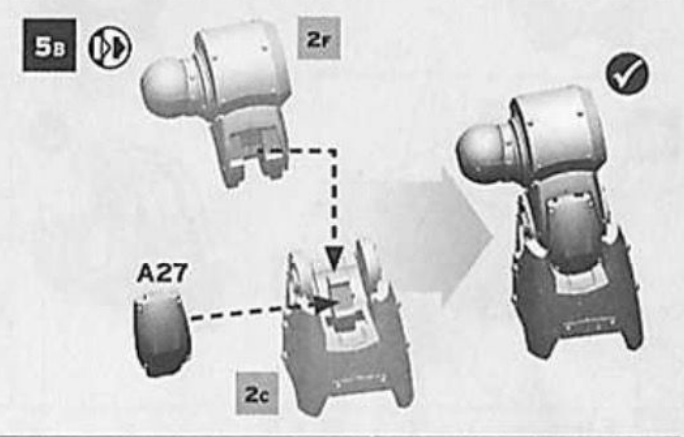
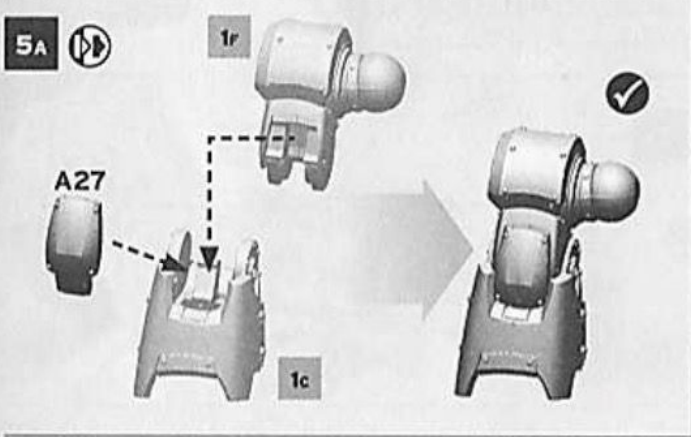
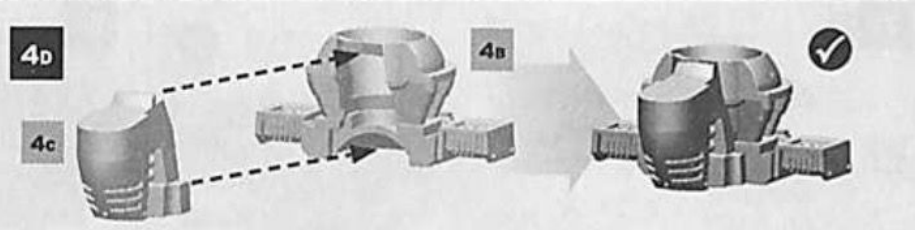
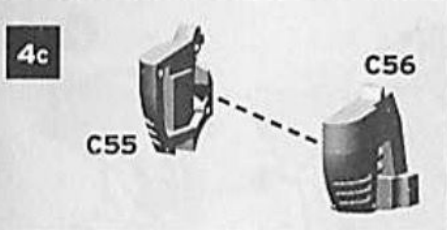
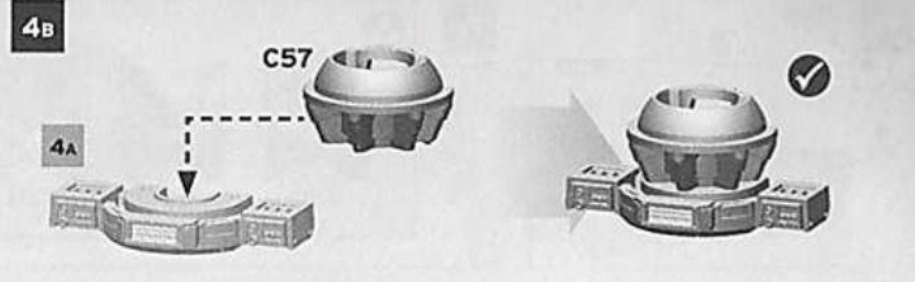
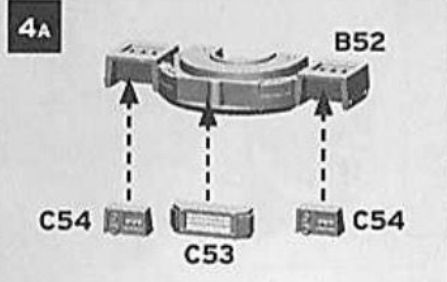

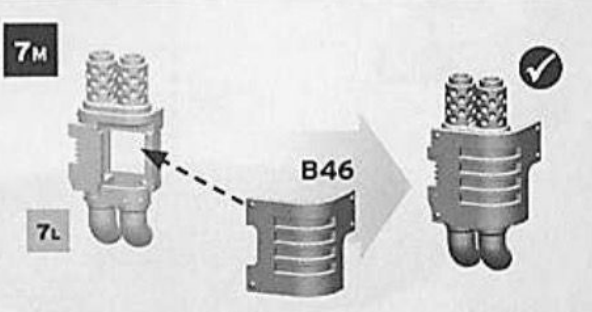
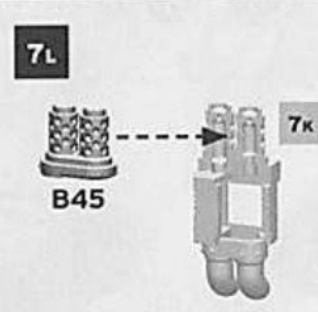
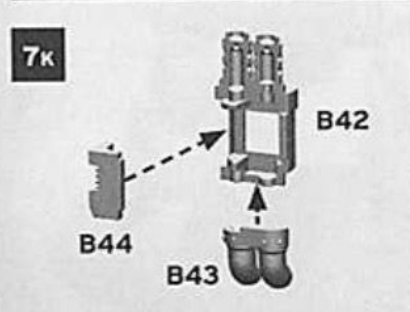
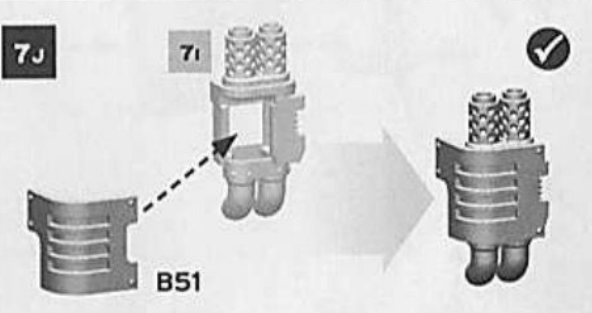
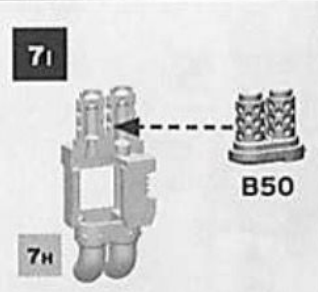
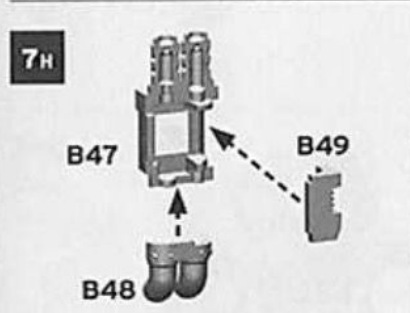
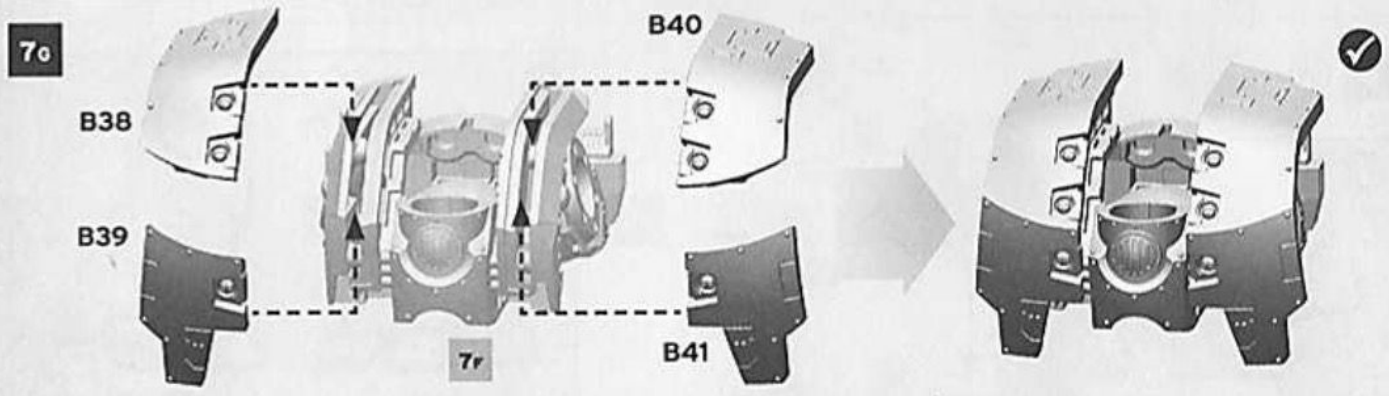
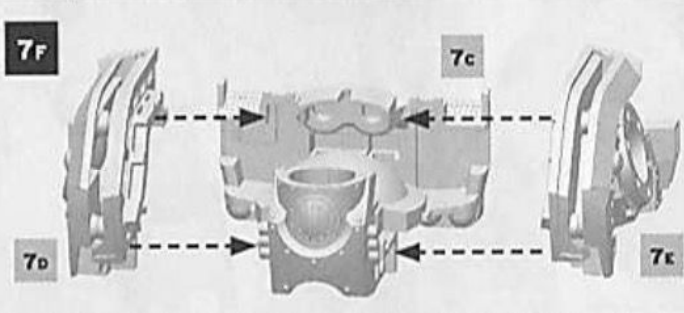
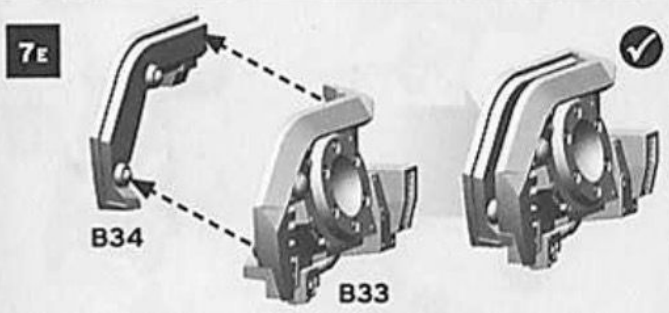
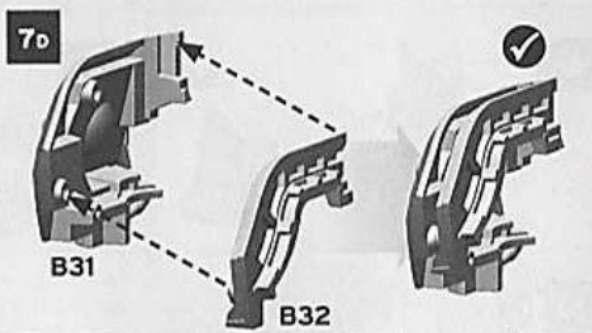
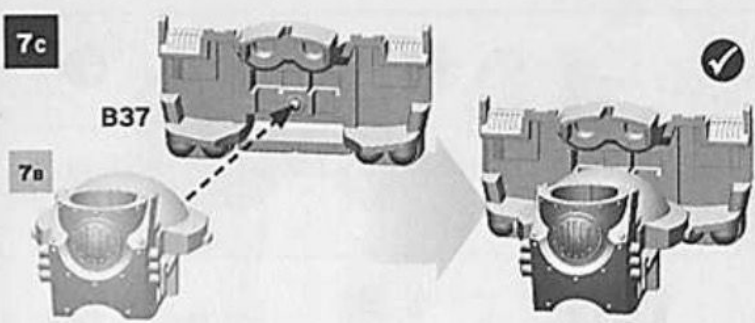
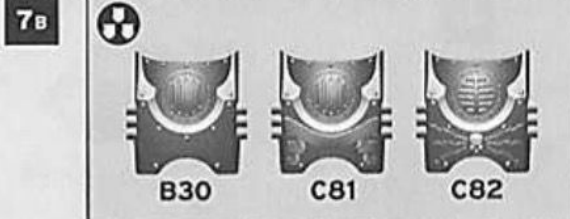

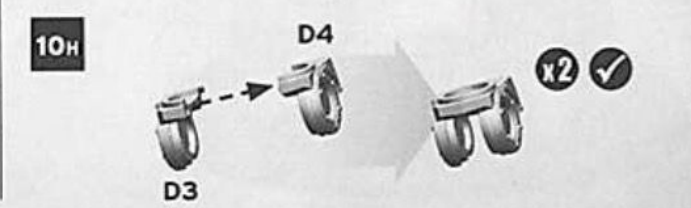
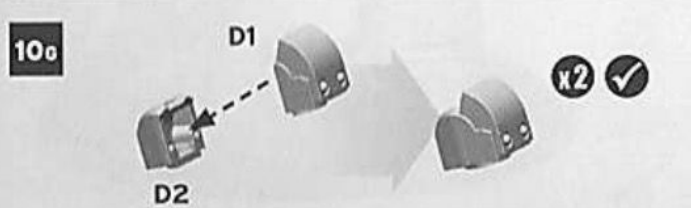
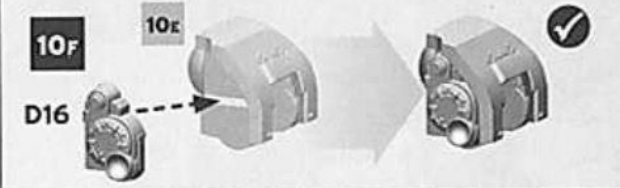
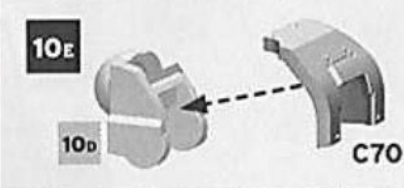
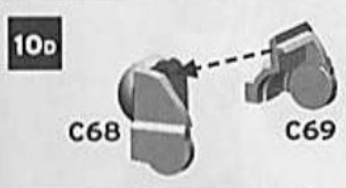
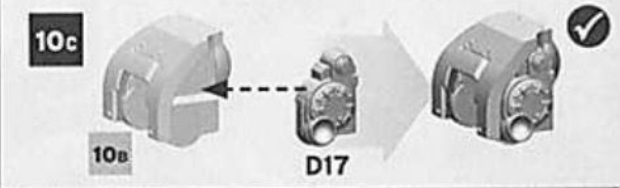
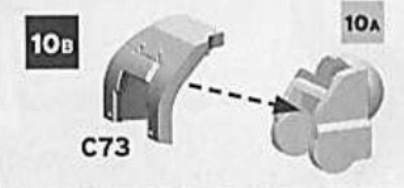
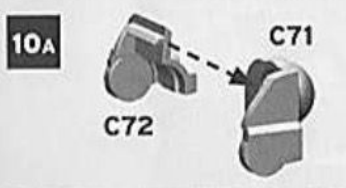
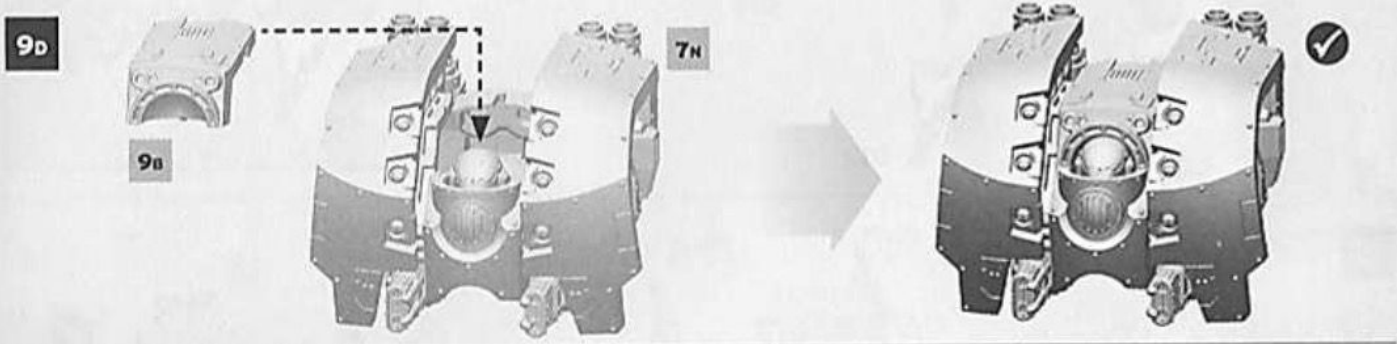
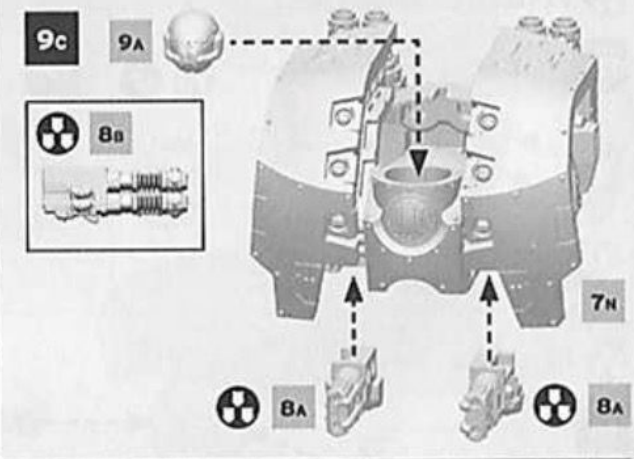
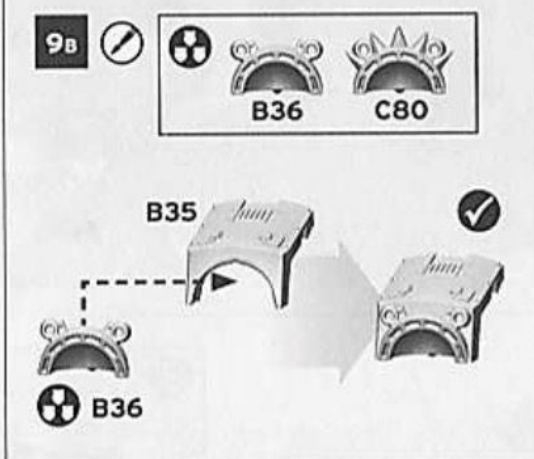
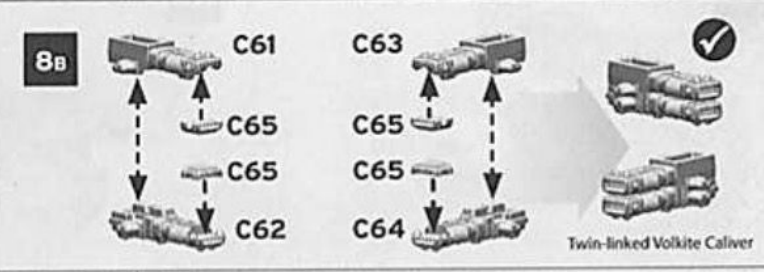
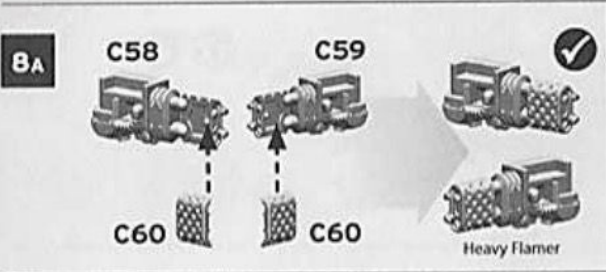
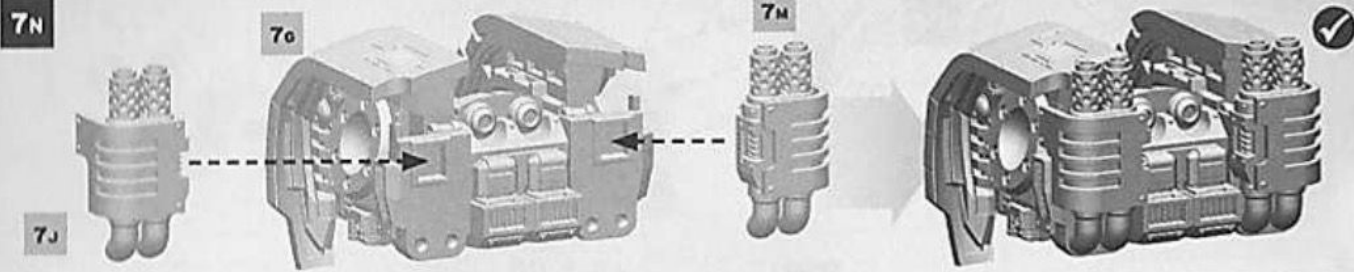

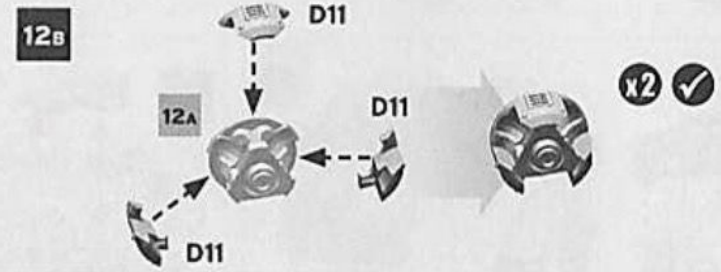
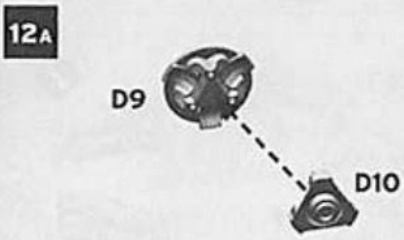
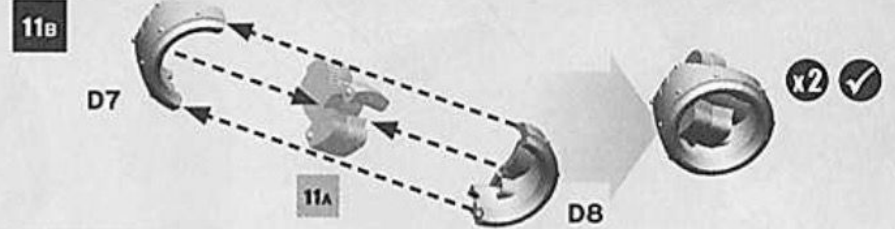
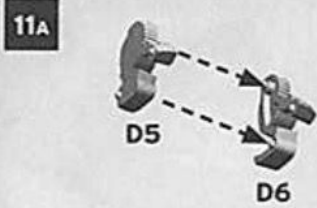

LEVIATHAN SIEGE DRILL

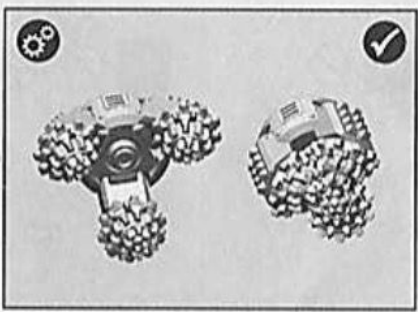
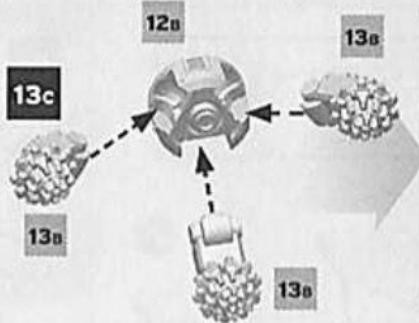
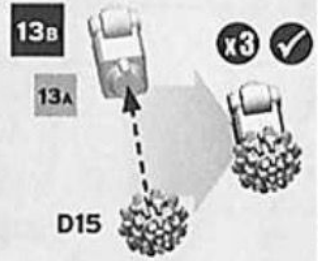
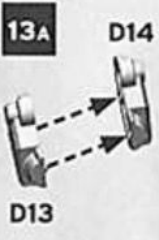

LEVIATHAN SIEGE CLAW

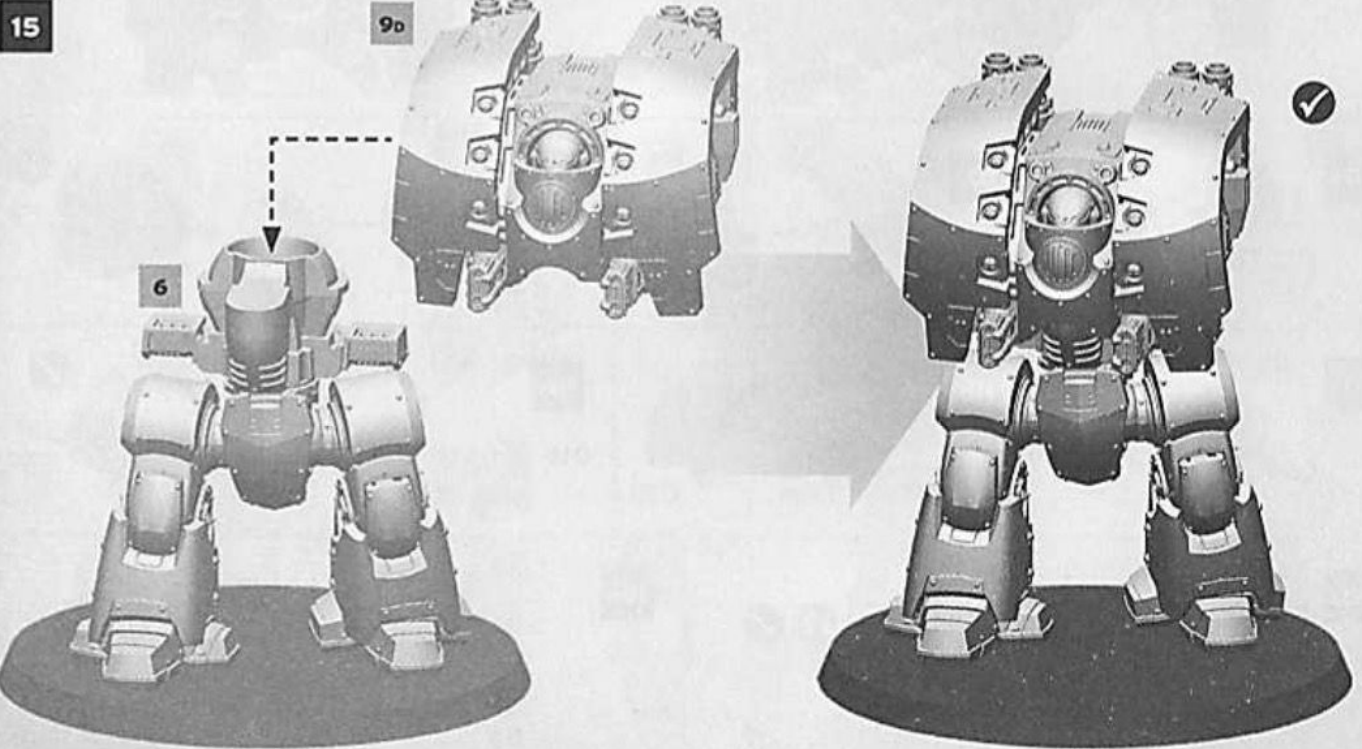
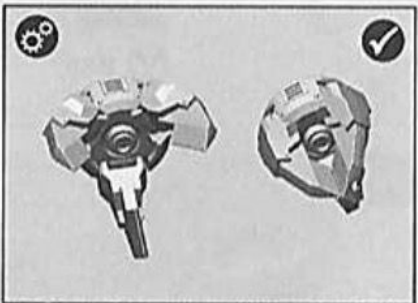
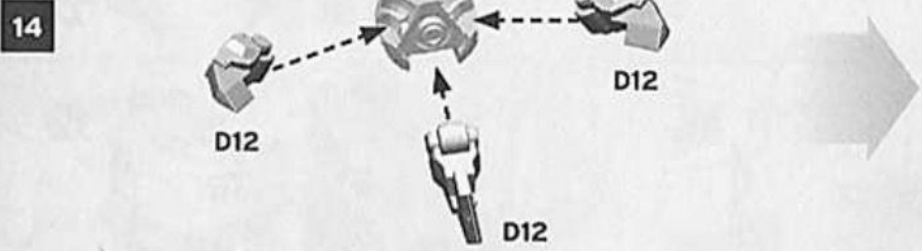

16



15

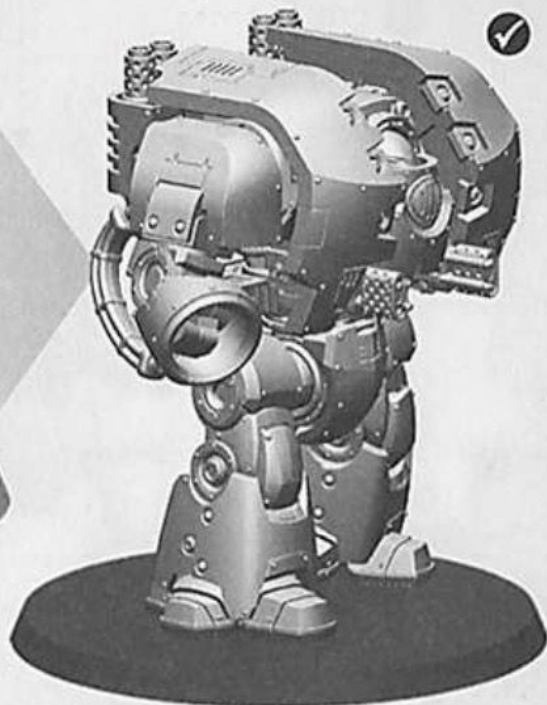
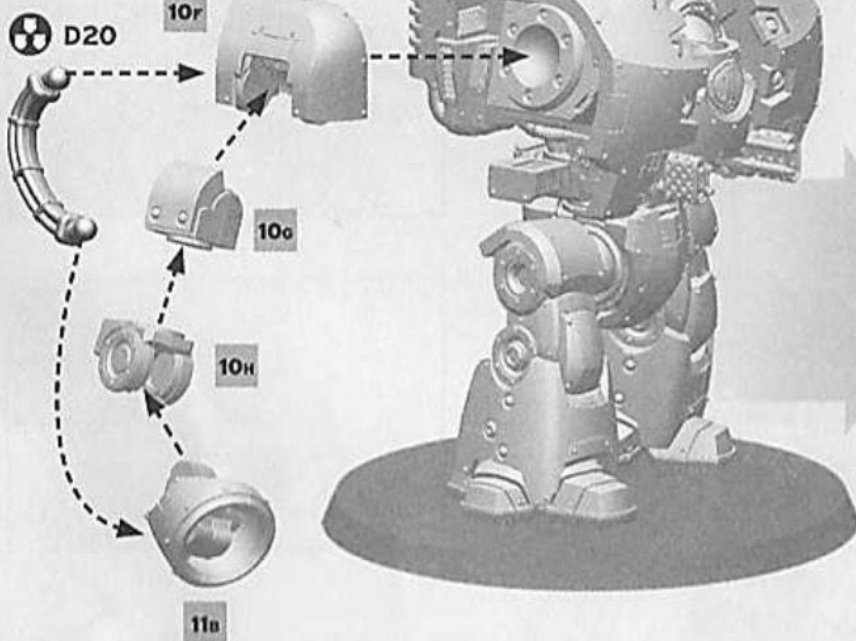

17

