



Free Downloads of Build Instructions,
Assembly Booklets & How To Guides

BuildInstructions.com

WARHAMMER® THE HORUS HERESY™

SOLAR AUXILIA BATTLE GROUP



READ THIS FIRST | À LIRE EN PRIORITÉ | BITTE BEACHTEN | LEE ESTO PRIMERO | LEGGI PRIMA QUESTO | 最初にお読みください。| 請優先閱讀

EN BEFORE ASSEMBLING YOUR MINIATURES, PLEASE READ THROUGH THE INSTRUCTIONS IN THIS BOOKLET CAREFULLY.

A pair of plastic cutters is required to remove the plastic components in this kit from their frame. We advise using a mouldline scraping tool to clean up the parts. To assemble your model you will need plastic glue. Games Workshop sells Citadel Fine Detail Cutters, Citadel Mouldline Removers and Citadel Plastic Glue, but does not recommend these products for use by children under the age of 16 without adult supervision.

FR AVANT D'ASSEMBLER VOS FIGURINES, VEUILLEZ LIRE ATTENTIVEMENT LES INSTRUCTIONS DE CE LIVRET.

Une pince coupante est requise pour détacher chaque élément de sa grappe plastique. Nous vous recommandons l'utilisation d'un ébarboir pour gratter chaque élément. Pour l'assemblage, vous aurez besoin de colle plastique. Games Workshop commercialise les Pinces de Précision Citadel, l'Ébarboir Citadel et la Colle Plastique Citadel, mais n'en recommande pas l'utilisation aux enfants de moins de 16 ans sans la supervision d'un adulte.

ES POR FAVOR, LEE CUIDADOSAMENTE ESTE LIBRETO DE INSTRUCCIONES ANTES DE EMPEZAR A MONTAR LAS MINIATURAS.

Te harán falta unas tenazas para plástico a fin de separar las piezas de la matriz. También aconsejamos una herramienta para quitar rebabas a fin de limpiar cada pieza. Para montar la miniatura necesitarás pegamento para plástico. Games Workshop vende Tenazas de detalle superfino, Quitarebabas Citadel y Pegamento para plástico Citadel, pero no recomienda estos productos a menores de 16 años sin supervisión de un adulto.

DE VOR DEM ZUSAMMENBAU DER MINIATUREN BITTE DIE ANWEISUNGEN IN DIESER ANLEITUNG AUFMERKSAM DURCHLESEN.

Du benötigst einen Kunststoffseitschneider, um die Kunststoffbauteile aus dem Gussrahmen herauszutrennen. Außerdem empfehlen wir, die Bauteile mit einem Gussgratentferner zu säubern. Um dein Modell zusammenzubauen, benötigst du Kunststoffkleber. Games Workshop bietet Präzisions-Seitschneider und Gussgratentferner von Citadel sowie Citadel-Kunststoffkleber an, empfiehlt aber, dass Kinder unter 16 Jahren diese nur unter Aufsicht eines Erwachsenen benutzen.

IT PRIMA DI ASSEMBLARE LE TUE MINIATURE LEGGI ATTENTAMENTE TUTTE LE ISTRUZIONI DI QUESTO LIBRETTO.

Sono necessarie un paio di tronchesine per plastica per staccare i componenti dal loro sprue. Consigliamo di usare un attrezzo apposito per pulire i componenti. Per assemblare il modello avrai bisogno di colla per plastica. Games Workshop vende Tronchesine di ultraprecisione Citadel, Attrezzo per ripulire Citadel e Colla per plastica Citadel, ma non consiglia questi prodotti ad un pubblico minore di 16 anni senza la supervisione di un adulto.

日 始める前に必ず説明書をお読みください。

本キット内のフレームからプラスチックパーツを切り離すためには、ニッパーが必要です。パーツのモールドを平らにするには、磨削ツールの使用をお勧めいたします。本キットの組み立てには、プラ用接着剤が必要です。ゲームズワークショップはスーパー・ファインディテール・カッター、シタデル・プラスチックグラー、シタデル・モールドラインリムーバーを販売しておりますが、16歳以下の子供が大人の監督なしにこれらの道具を使用されることをお勧めしません。

中 在組裝您的迷你模型之前，請仔細閱讀本手冊中的說明。

您需要一把模型剪將塑料零件從製作上拆下來。我們建议使用模型刮刀来处理零件。组装时您还需要用到塑料胶水。您可以从 Games Workshop 处购买到 Citadel 精密剪剪、Citadel 模线刮刀和 Citadel 塑料胶水。但 16 岁以下儿童不得在没有成年人监护的情况下使用这些产品。

LEMAN RUSS STRIKE TANK

99393005004, 99393005005, 99393005006, 99393005009, 99393005010

20A



20B

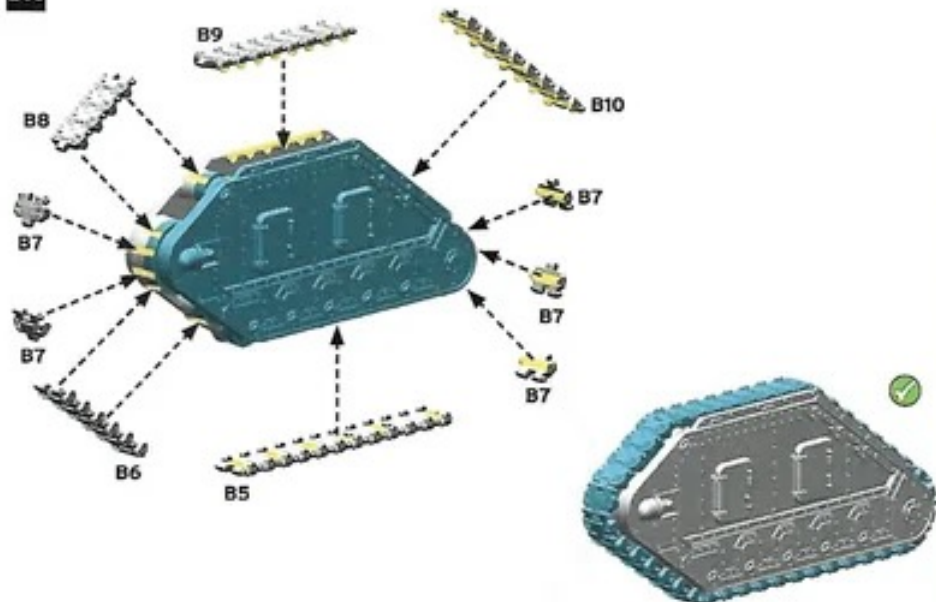

21A

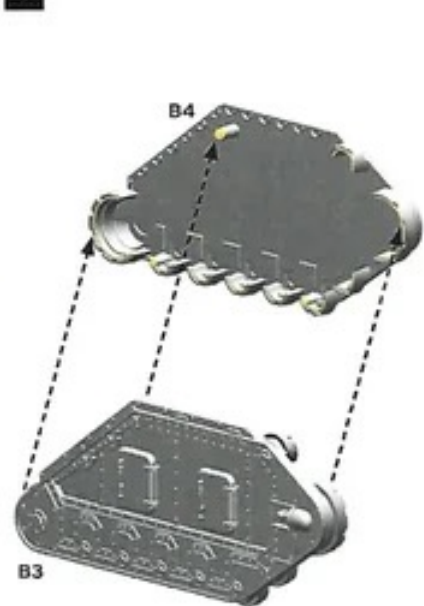

21B

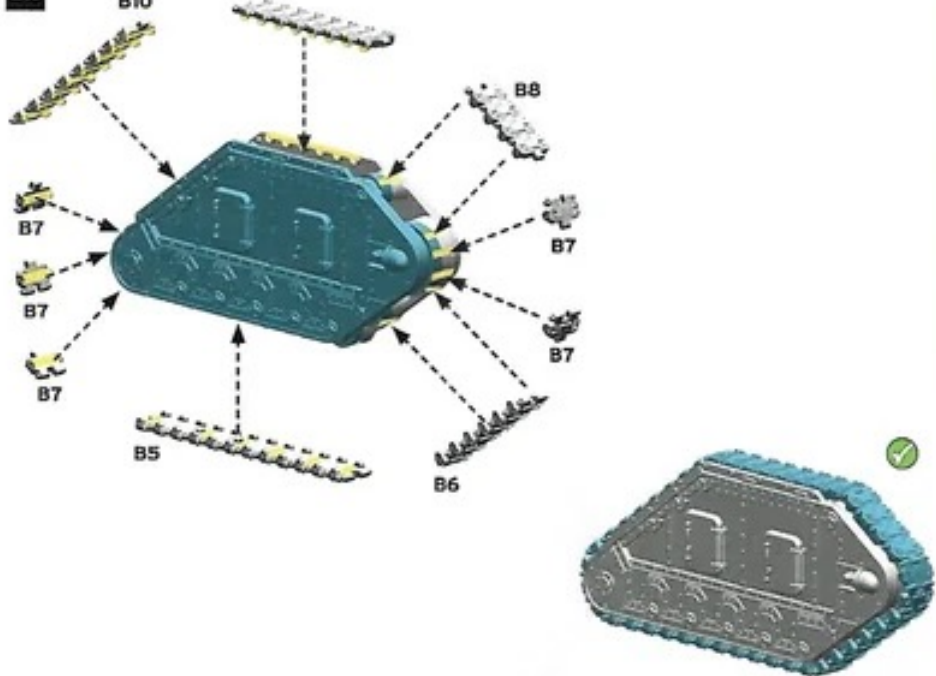

22A



22B



22c

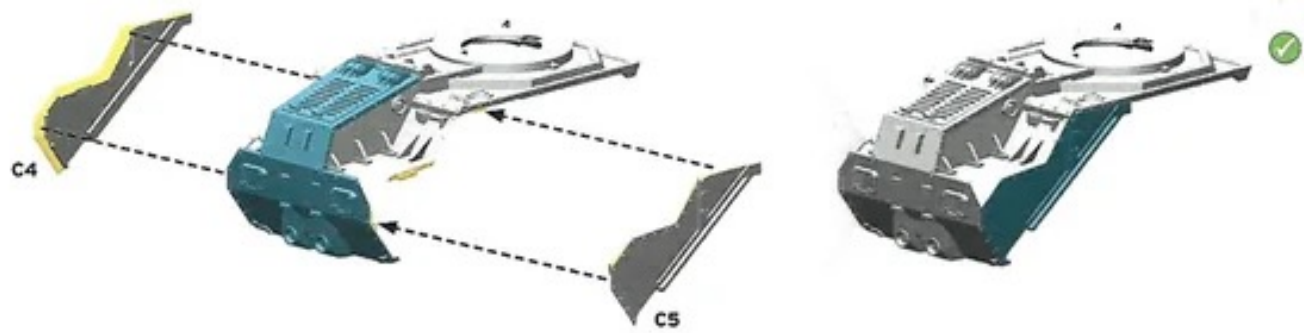

23a

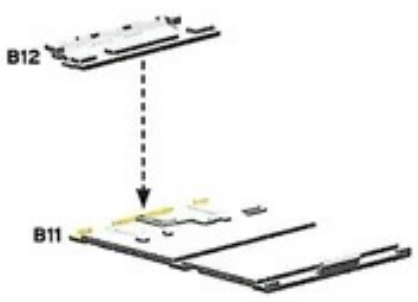

23b

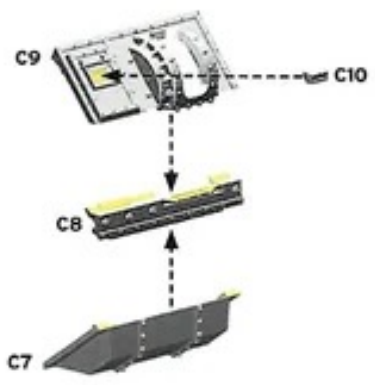

23c

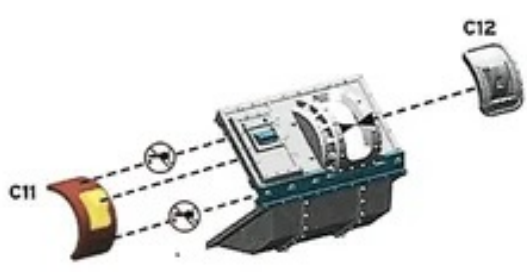

23d

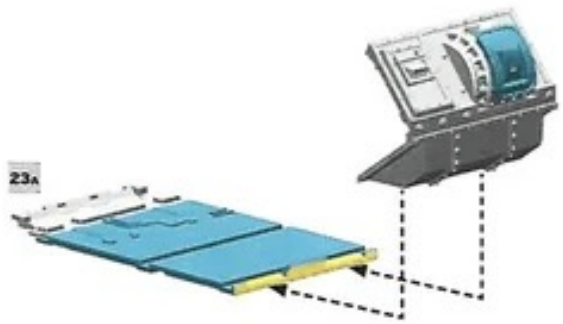

23e

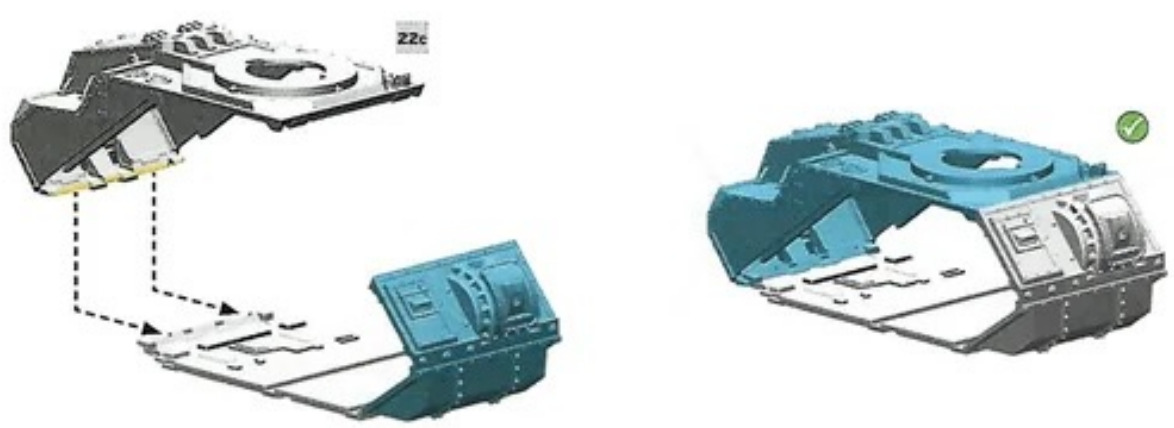

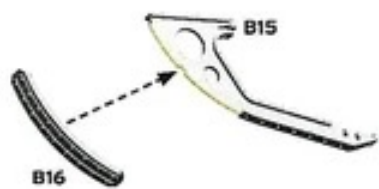
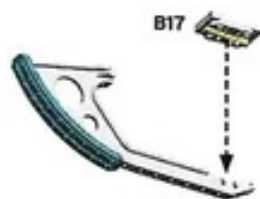
24a 24b 

24c

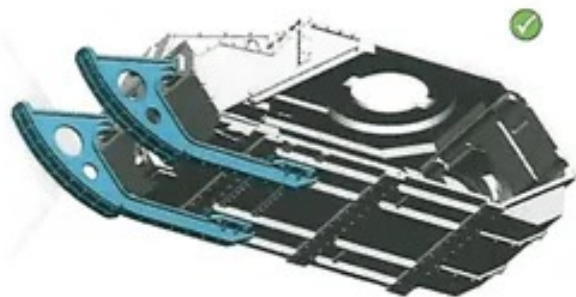
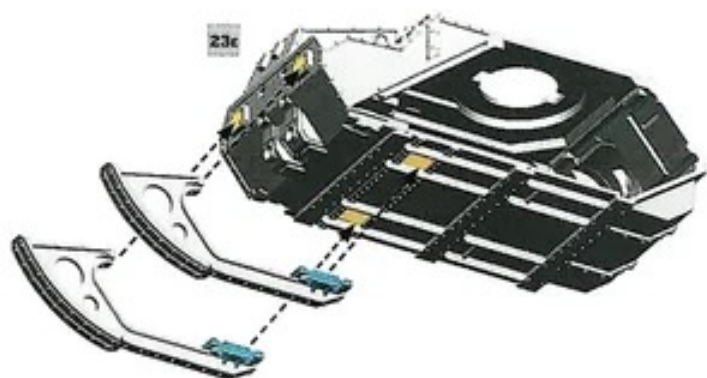

25

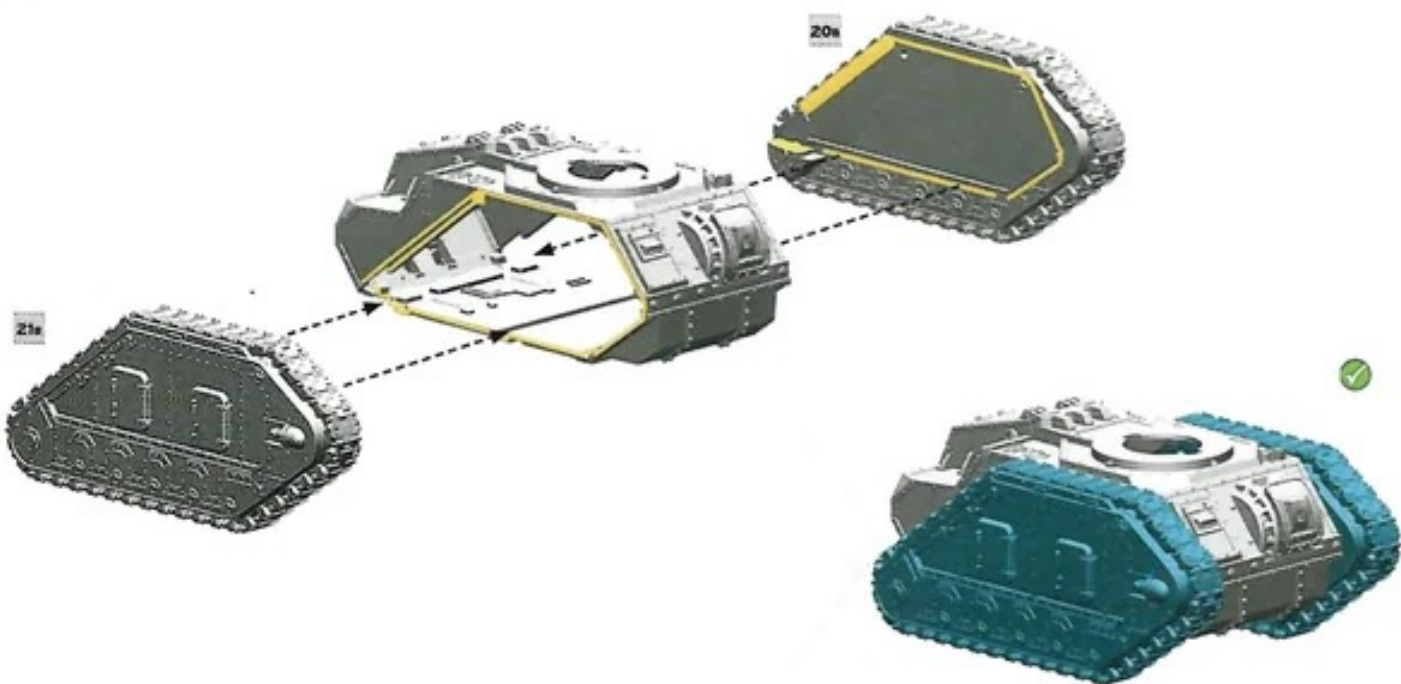

26a

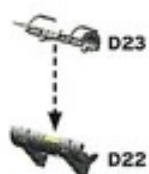

26b



27

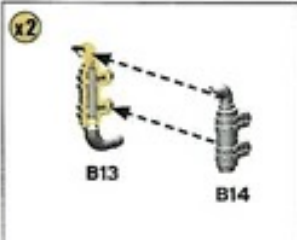

28A

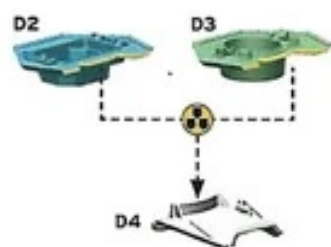
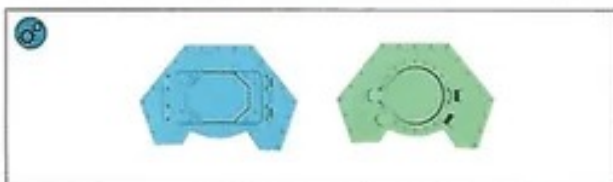

28B



29



30



30



BATTLECANNON



GRAVIS LASCANNON



VANQUISHER BATTLECANNON
with co-axial autocannon



GRAVIS AUTOCANNON

BATTLECANNON

31

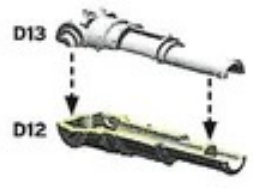

GRAVIS LASCANNON

32

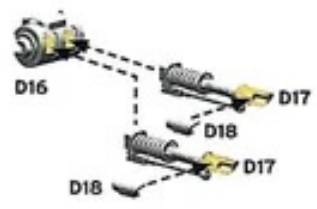

VANQUISHER BATTLECANNON

33

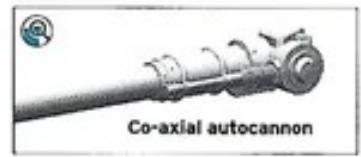
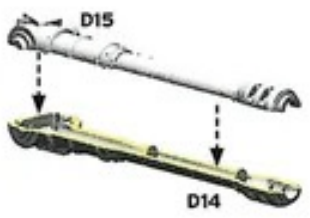

Co-axial autocannon



GRAVIS AUTOCANNON

34

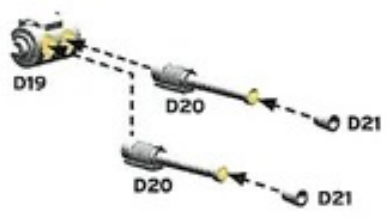

35



36

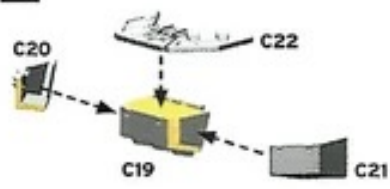

37A



37B



37C

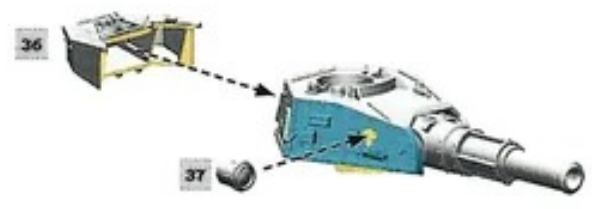

38A



38B



39A

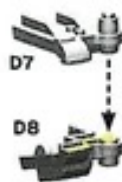

39B

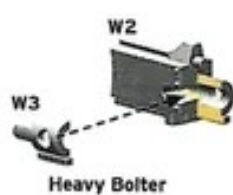

Heavy Bolter



Lascannon

40

Heavy Bolter



Lascannon



W1. Autocannon



W4. Multi-laser



W7. Heavy Flamer



41

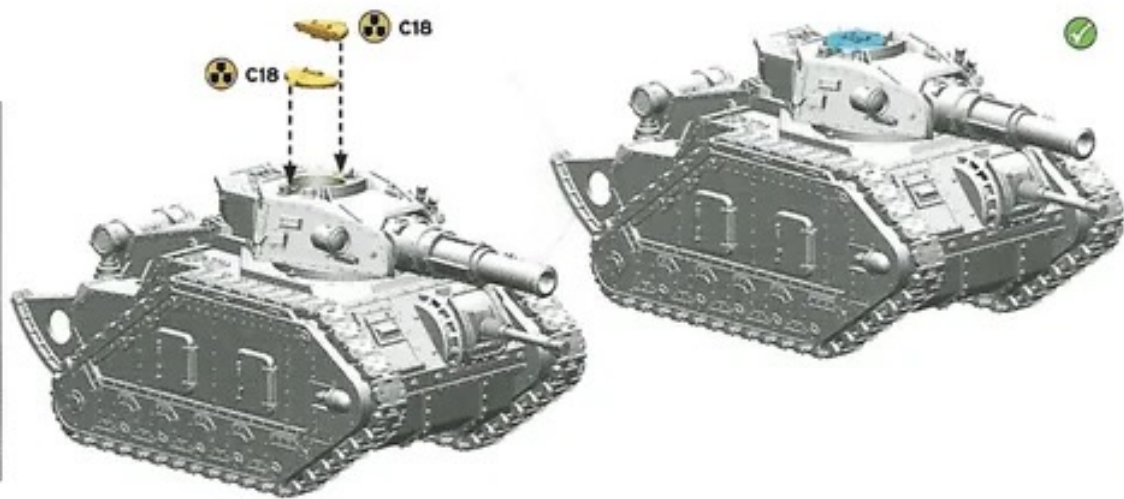

TANK COMMANDER

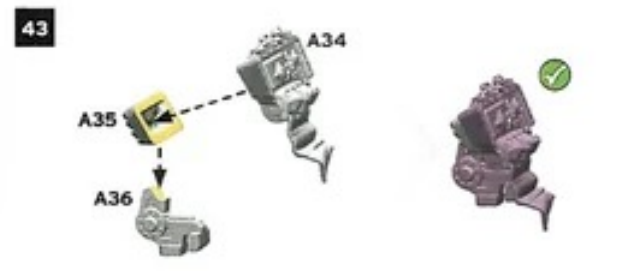
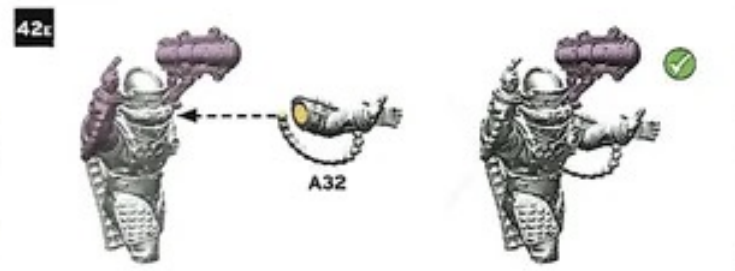
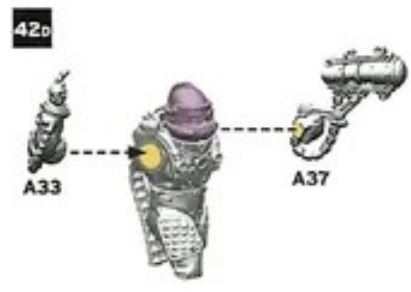
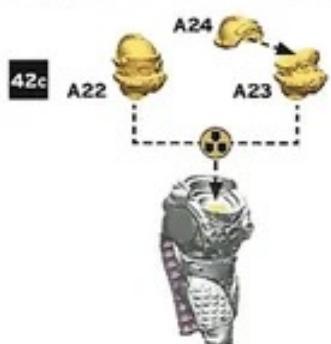

44

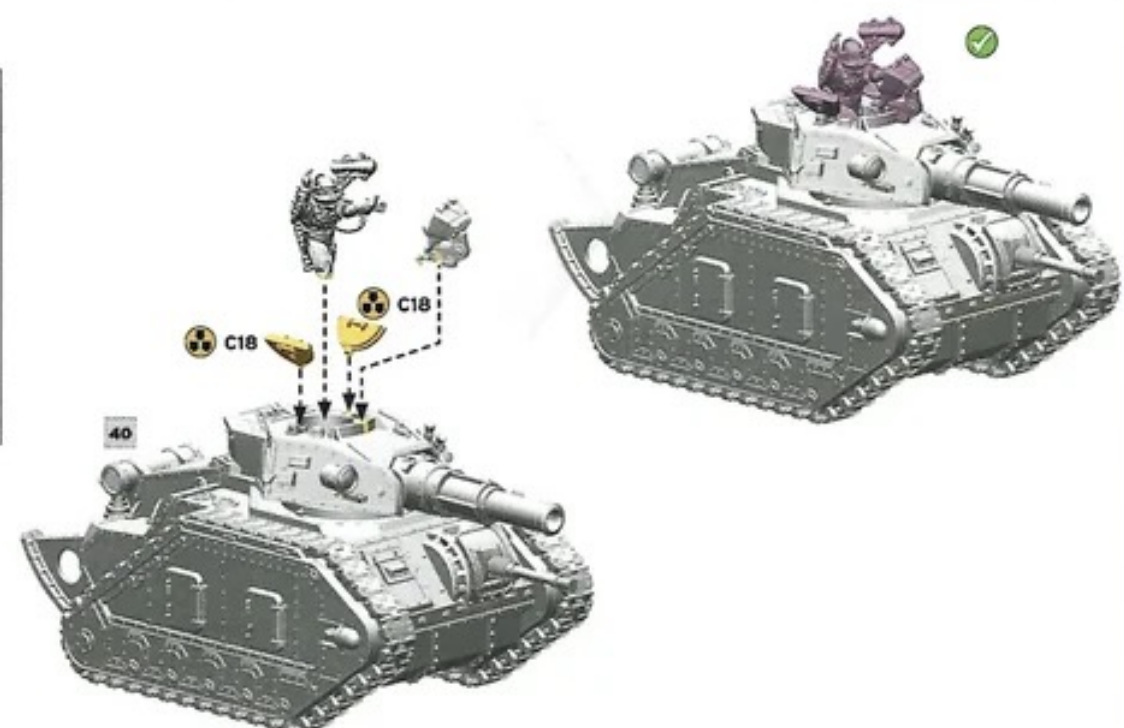

TANK COMMANDER WITH PINTLE WEAPON

45



Heavy Flamer



Multi-laser

46

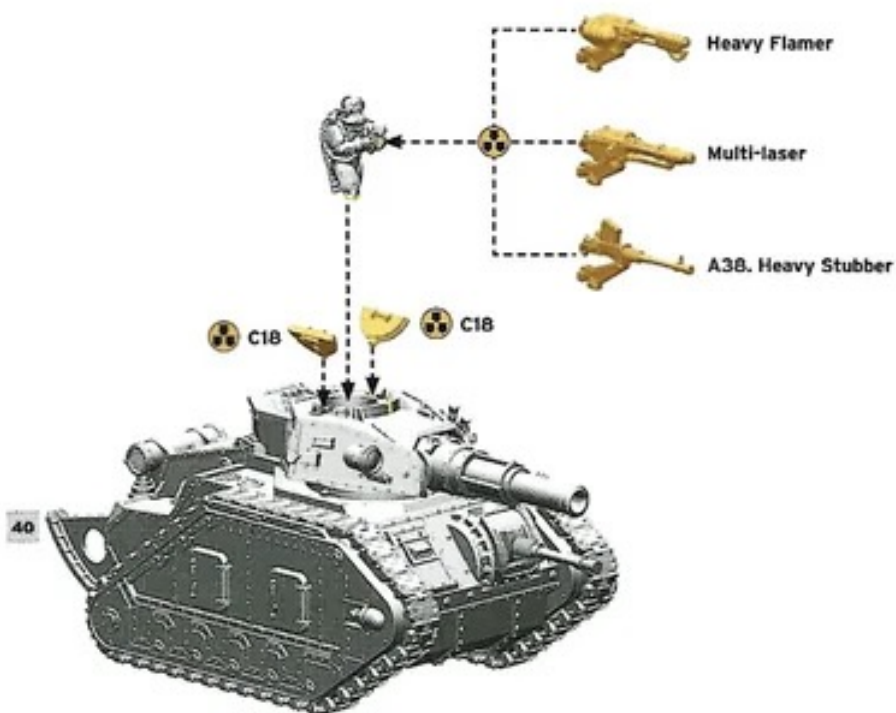
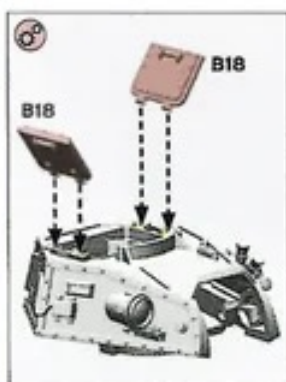

40



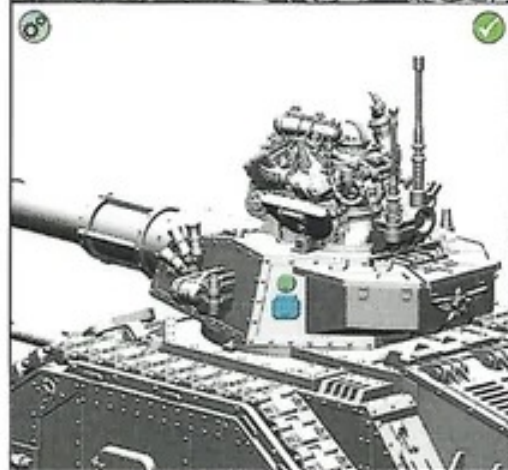
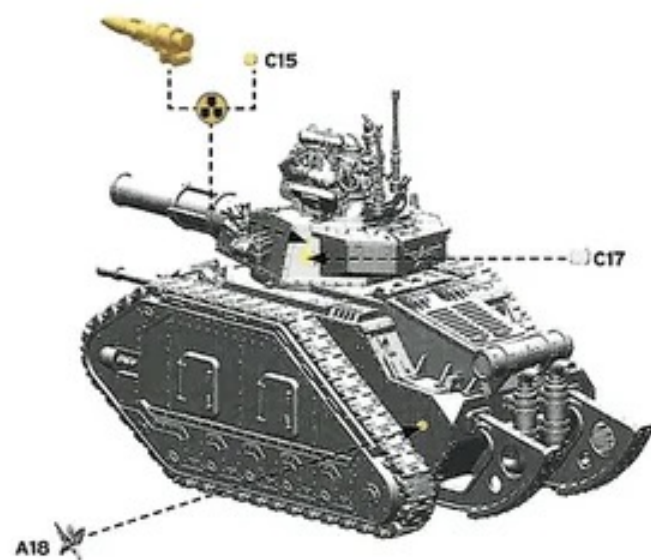
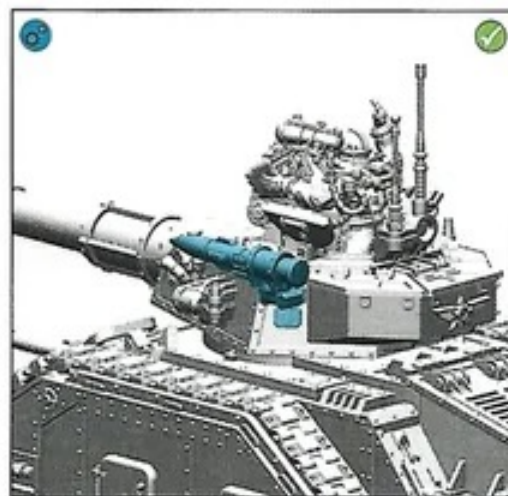
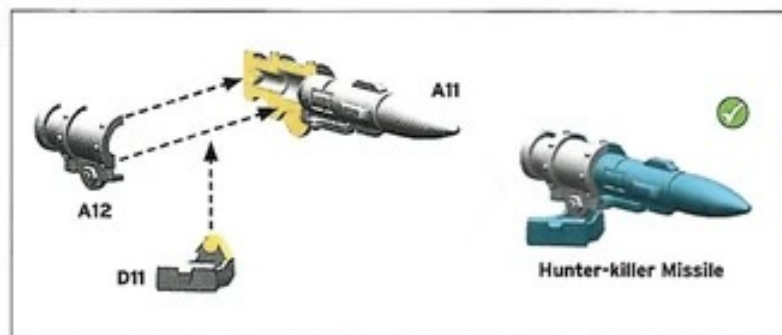
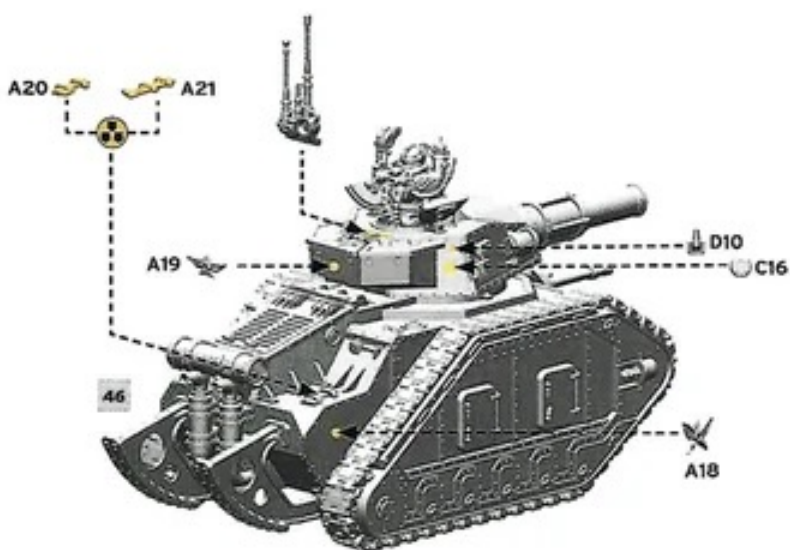
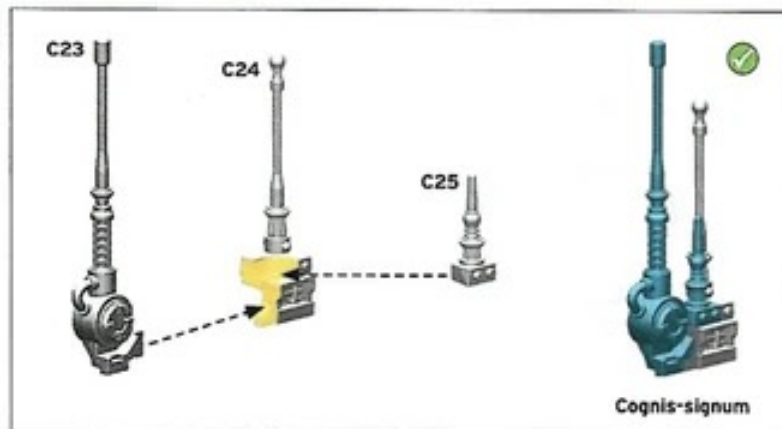

49A 12

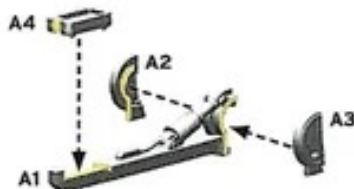

49B



50A

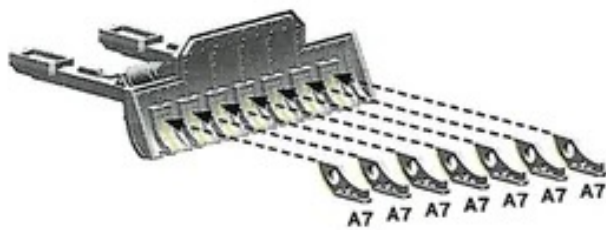

50B

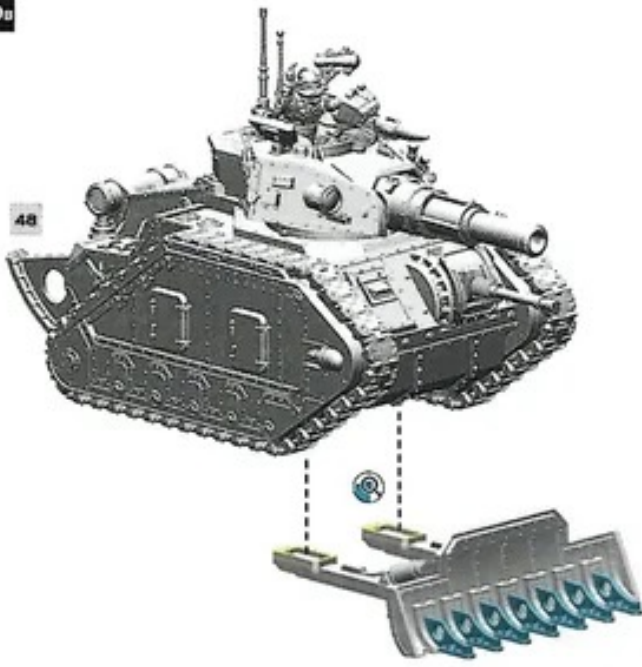

Dozer Blade

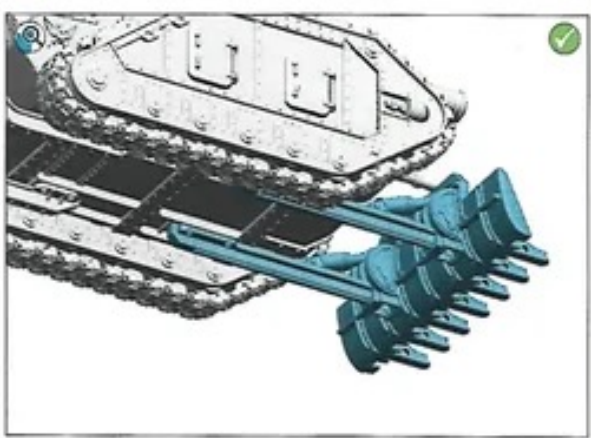

51

