



Free Downloads of Build Instructions,
Assembly Booklets & How To Guides

BuildInstructions.com

WARLORD BATTLE TITAN WITH PLASMA ANNIHILATOR AND POWER CLAW

READ THIS FIRST | À LIRE EN PRIORITÉ | BITTE BEACHTE | LEE ESTO PRIMERO
LEGGI PRIMA QUESTO | 最初にお読みください。| 请优先阅读

ENG BEFORE ASSEMBLING YOUR MINIATURES, PLEASE READ THROUGH THE INSTRUCTIONS IN THIS BOOKLET CAREFULLY.

A pair of plastic cutters is required to remove the plastic components in this kit from their frame. We advise using a mouldline scraping tool to clean up the parts. To assemble your model you will need plastic glue. Games Workshop sells Citadel Fine Detail Cutters, Citadel Mouldline Removers and Citadel Plastic Glue, but does not recommend these products for use by children under the age of 16 without adult supervision.

FRE AVANT D'ASSEMBLER VOS FIGURINES, VEUILLEZ LIRE ATTENTIVEMENT LES INSTRUCTIONS DE CE LIVRET.

Une pince coupante est requise pour détacher chaque élément de sa grappe plastique. Nous vous recommandons l'utilisation d'un ébarboir pour gratter chaque élément. Pour l'assemblage, vous aurez besoin de colle plastique. Games Workshop commercialise les Pinces de Précision Citadel, l'Ébarboir Citadel et la Colle Plastique Citadel, mais n'en recommande pas l'utilisation aux enfants de moins de 16 ans sans la supervision d'un adulte.

SPA POR FAVOR, LEE CUIDADOSAMENTE ESTE LIBRETO DE INSTRUCCIONES ANTES DE EMPEZAR A MONTAR LAS MINIATURAS.

Te harán falta unas tenazas para plástico a fin de separar las piezas de la matriz. También aconsejamos una herramienta para quitar rebabas a fin de limpiar cada pieza. Para montar la miniatura necesitarás pegamento para plástico. Games Workshop vende Tenazas de detalle superfino, Quitarrebabas Citadel y Pegamento para plástico Citadel, pero no recomienda estos productos a menores de 16 años sin la supervisión de un adulto.

GER VOR DEM ZUSAMMENBAU DER MINIATUREN BITTE DIE ANWEISUNGEN IN DIESER ANLEITUNG AUFMERKSAM DURCHLESEN.

Du benötigst einen Kunststoffseitenschneider, um die Kunststoffbauteile aus dem Gussrahmen herauszutrennen. Außerdem empfehlen wir, die Bauteile mit einem Gussgratentferner zu säubern. Um dein Modell zusammenzubauen, benötigst du Kunststoffkleber. Games Workshop bietet Präzisions-Seitenschneider und Gussgratentferner von Citadel sowie Citadel-Kunststoffkleber an, empfiehlt aber, dass Kinder unter 16 Jahren diese nur unter Aufsicht eines Erwachsenen benutzen.

ITA PRIMA DI ASSEMBLARE LE TUE MINIATURE LEGGI ATTENTAMENTE TUTTE LE ISTRUZIONI DI QUESTO LIBRETTO.

Sono necessarie un paio di tronchesine per plastica per staccare i componenti dai loro sprue. Consigliamo di usare un attrezzo apposito per pulire i componenti. Per assemblare il modello avrai bisogno di colla per plastica. Games Workshop vende Tronchesine di ultraprecisione Citadel, Attrezzo per ripulire Citadel e Colla per plastica Citadel, ma non consiglia questi prodotti ad un pubblico minore di 16 anni senza la supervisione di un adulto.

日本語 始める前に必ず説明書をお読みください。本キット内のフレームからプラスチックパーツを切り離すためには、ニッパーが必要です。パーツのモールドを平らにするには、専用ツールを使用をお勧めいたします。本キットの組み立てには、プラ用接着剤が必要です。ゲームワークショップはスーパー・ファインディテール・カッター・シタデル・プラスチックグレー・シタデル・モールドラインリムーバーを販売しておりますが、16歳以下の子供が大人の監督なしにこれらの道具を使用されることをお勧めしません。

中文 在组装您的微缩模型之前，请仔细阅读本手册中的说明。

您需要一把模型剪将塑料部件从版件上剪下来。我们建议使用横线刮刀来处理零件。组装时您还需要用到塑料胶水。您可以从 Games Workshop 处购买到 Citadel 精密剪、Citadel 横线刮刀和 Citadel 塑料胶水，但 16 岁以下儿童不得在没有成年人监护的情况下使用这些产品。

16+

Citadel Plastic Glue
Colle plastique liquide Citadel
Pegamento para plástico fluido
Citadel-Kunststoffkleber
Colla per plastica fluida Citadel
シタデルプラスチック接着剤流し込みタイプ
Citadel 塑料灌缝粘胶



Super Fine Detail Cutters
Pince Coupante de Précision
Tenazas de detalle superfino
PRÄZISIONS-SEITENSCHNEIDER
Tronchesine di ultraprecisione
スーパー・ファインディテール・カッター
精密剪钳



Mouldline Remover
Ébarboir
Quita-rebabas
Gussgratentferner
Attrezzo per ripulire
モールドライン・リムーバー
合横线刮刀

EXPLANATION OF SYMBOLS | EXPLICATION DES SYMBOLES EXPLICACIÓN DE SÍMBOLOS | ERLÄUTERUNG DER SYMBOLE LEGENDA DEI SIMBOLI | アイコン解説 | 符号说明

- Special instruction - take care
- Instruction spéciale - faites attention
- Instrucciones especiales - presta atención
- Besondere Anweisung - bitte beachten
- Istruzioni speciali: prestare attenzione
- 特記事項 - 要注意
- 特别说明 - 小心
- Dry fit stage before gluing
- Tester avant de coller
- Comprobar el encaje antes de pegar
- Positionierung erst ohne Klebstoff ausprobieren
- Prova a secco prima di incollare
- 接着前にぴったり合わせること
- 粘接前的假组阶段
- Paint before assembly
- Peindre avant assemblage
- Pintar antes del montaje
- Erst bemalen, dann zusammenbauen
- Dipingi prima dell'assemblaggio
- 組み立て前にペイントすること
- 组装前涂装
- Reversible parts
- Éléments Réversibles
- Piezas reversibles
- Beidseitig benutzbar
- Componenti a doppia faccia
- リバーシブル・パーツ
- 可翻转部件
- Choice of parts
- Choix d'éléments
- Piezas opcionales
- Auswahl an Teilen
- Scelta di componenti
- パーツの選択
- 选择部件
- Repeat process
- Répéter l'étape
- Repetir pasos
- Vorgang wiederholen
- Ripeti il processo
- 同じ作業を繰り返すこと
- 重复步骤
- Detail view
- Vue détaillée
- Vista detallada
- Alternative Ansicht
- Visuale del dettaglio
- 拡大
- 局部放大视图
- Stage complete
- Étape terminée
- Paso completado
- Schritt abgeschlossen
- Fase completa
- このステージの完成
- 完成



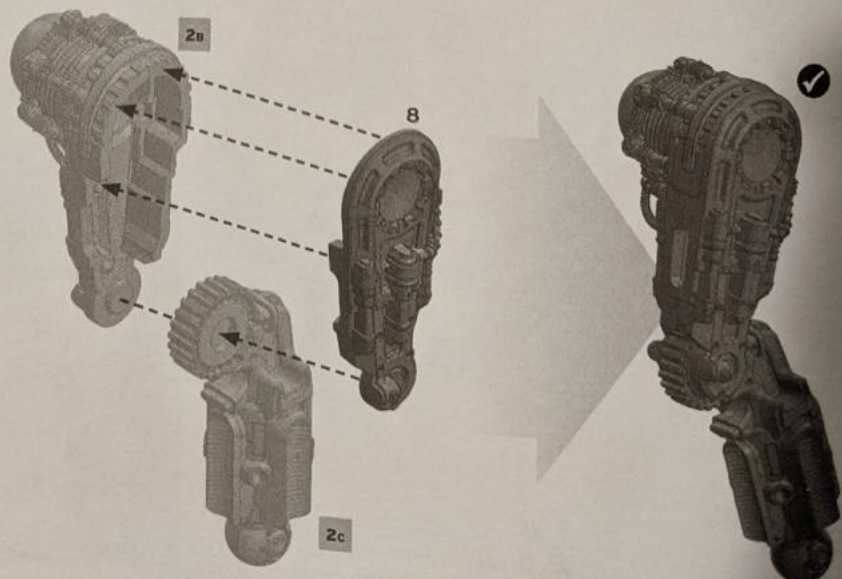
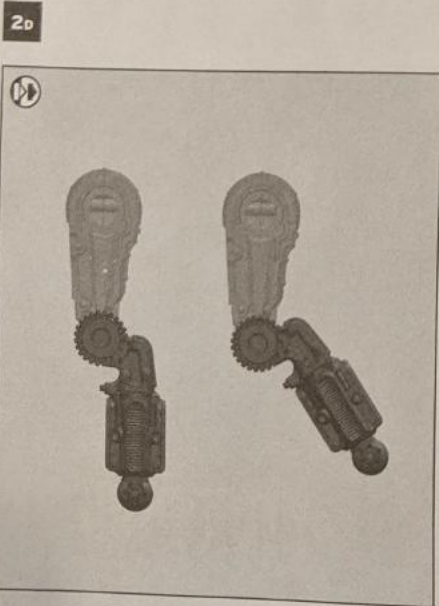
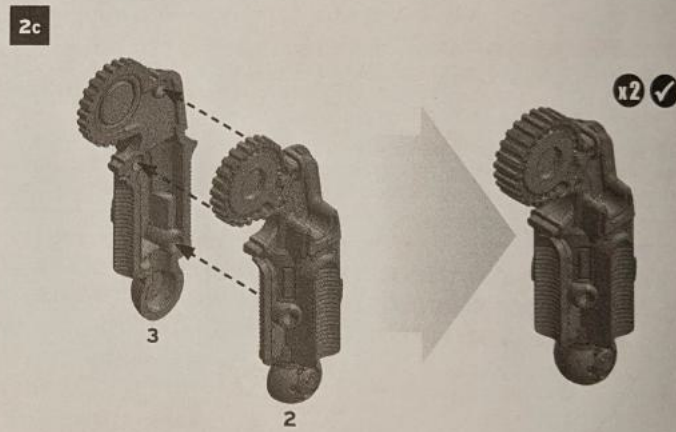
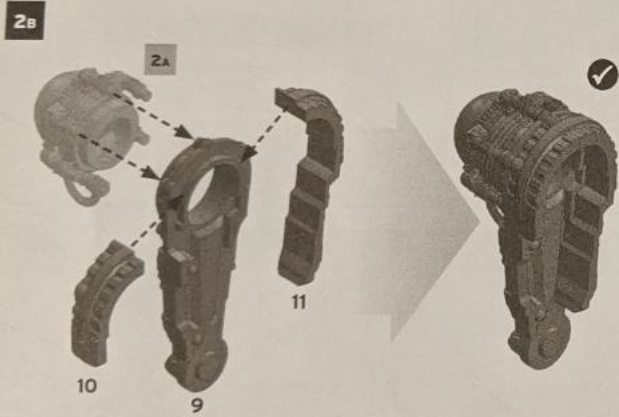
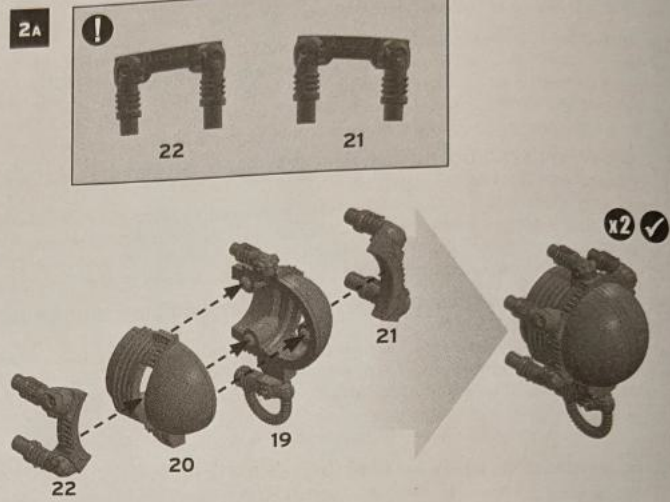
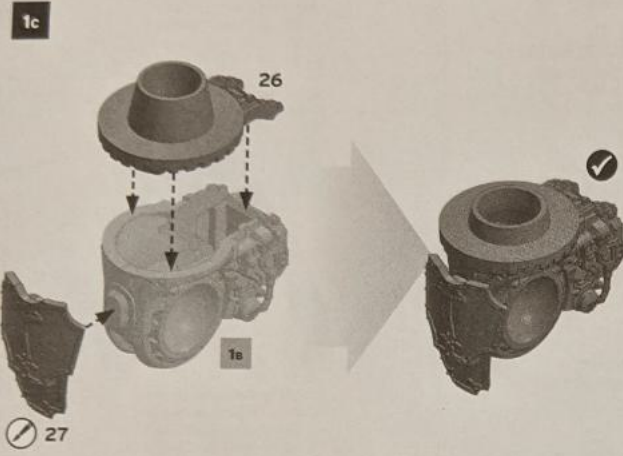
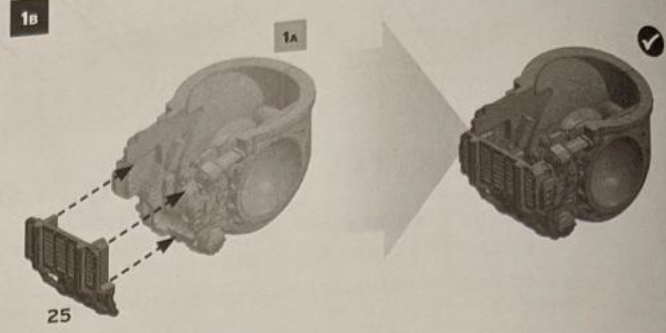
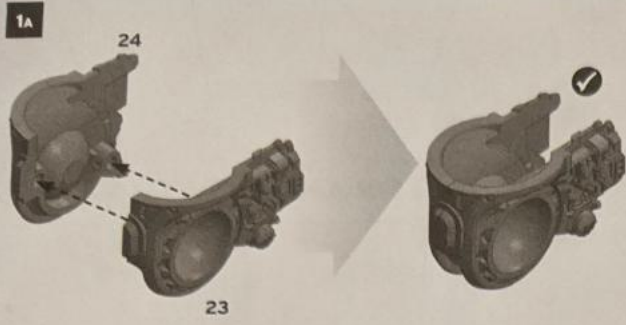

3A

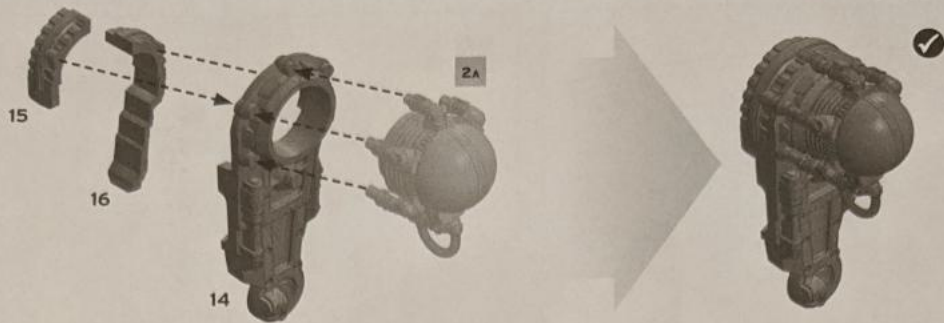

3B

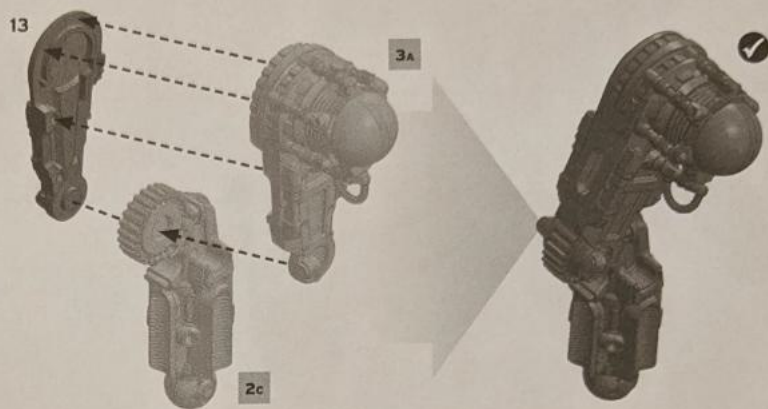
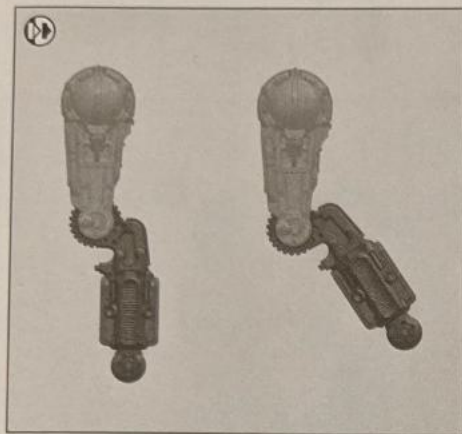

4A

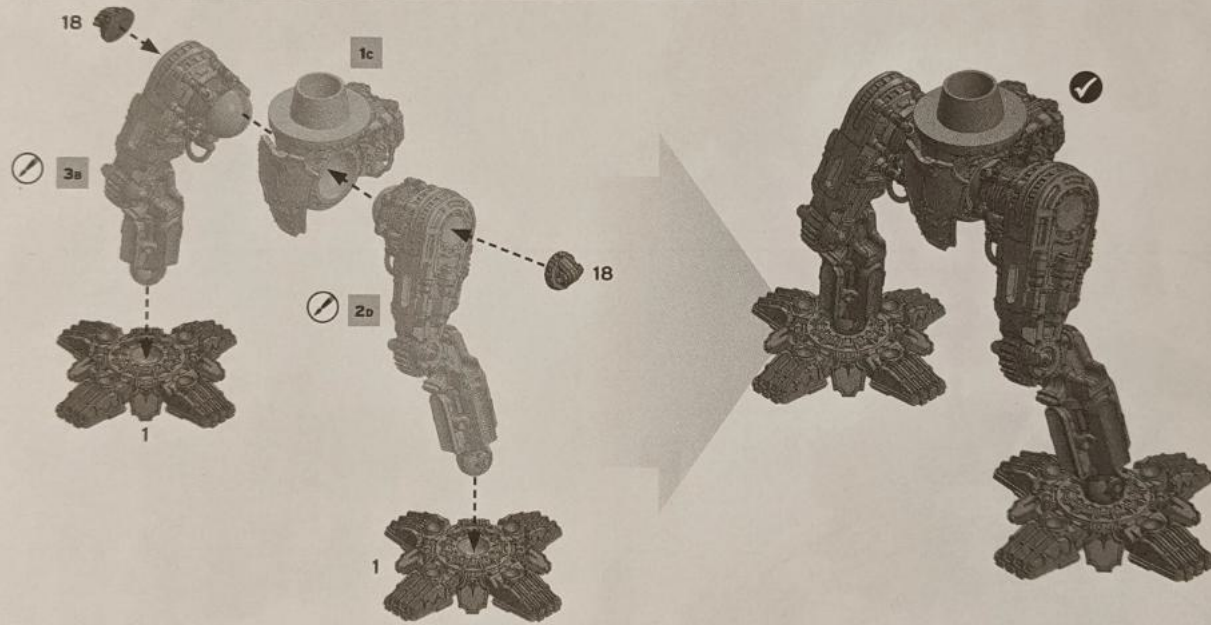

4B

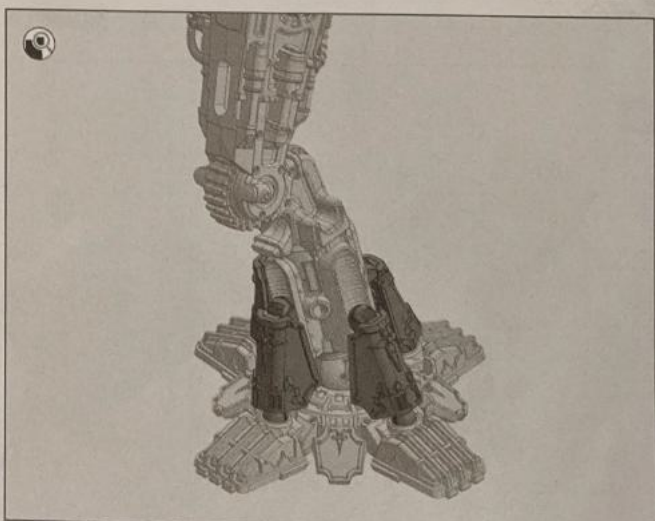
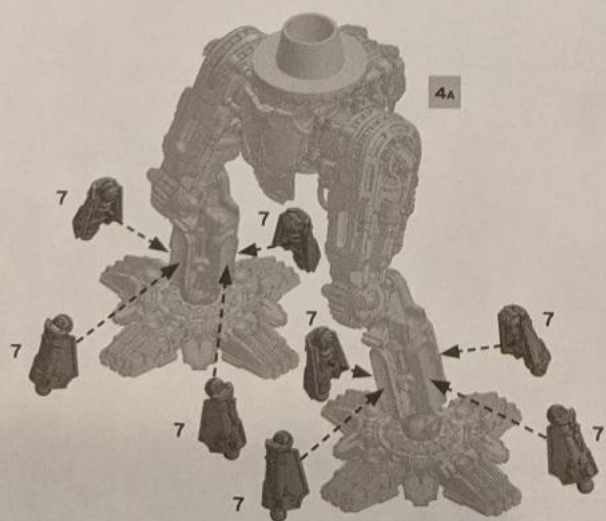

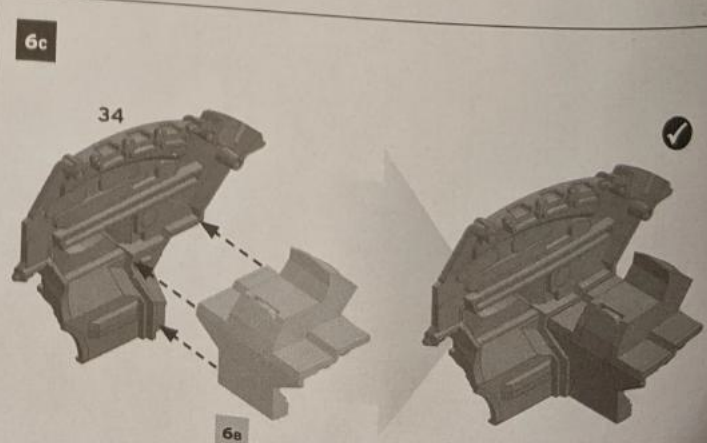
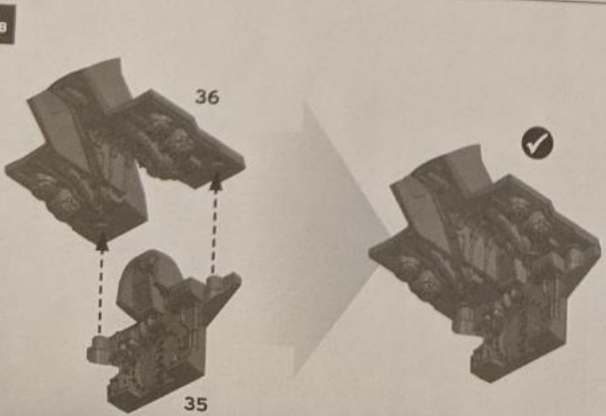
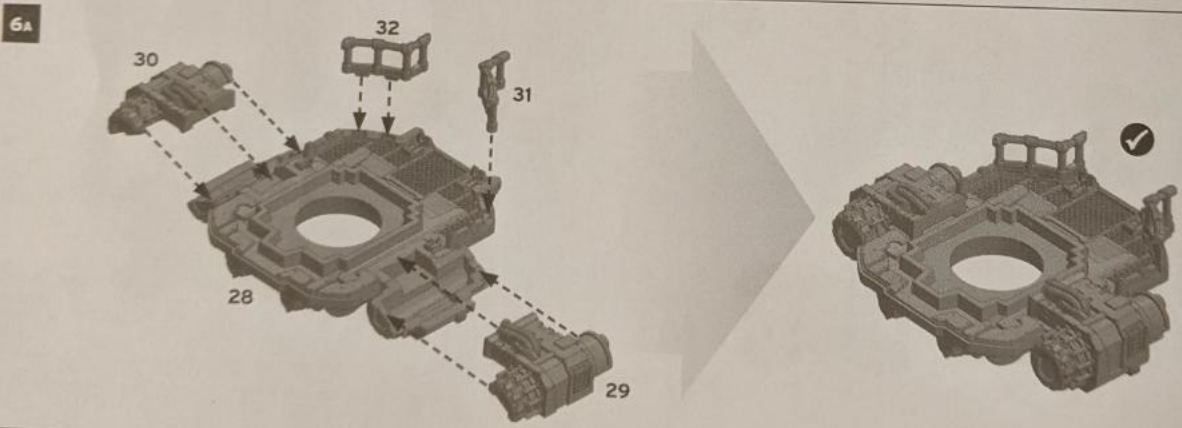
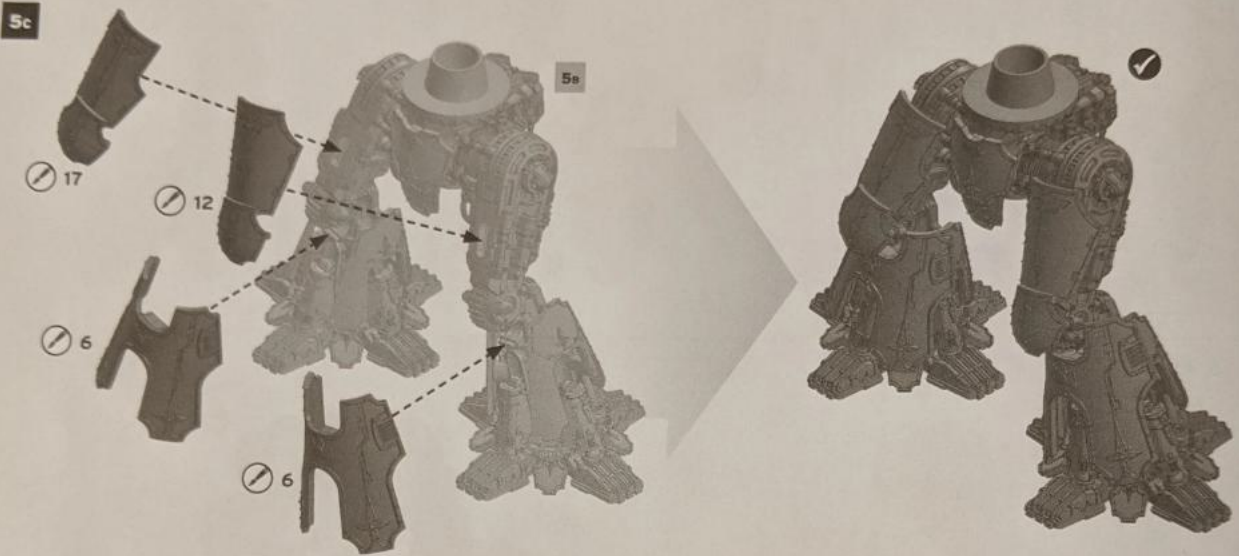
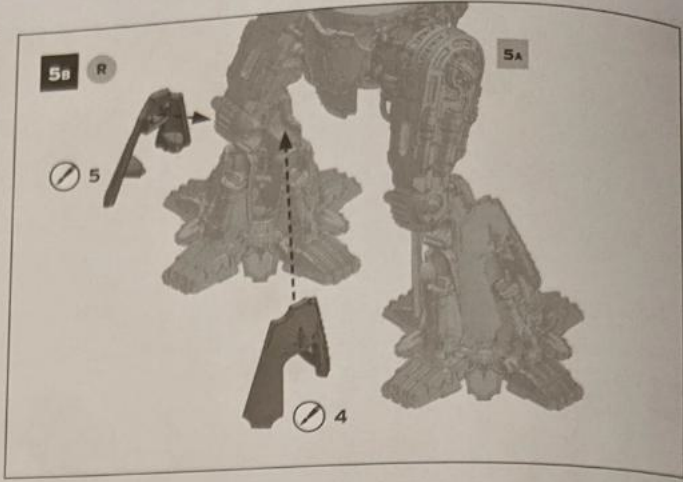
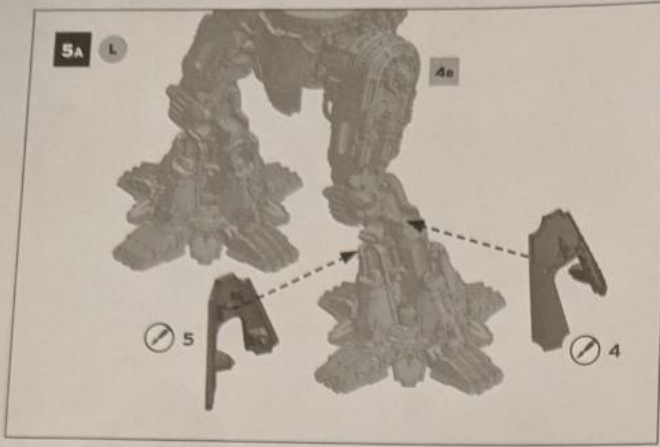

7A

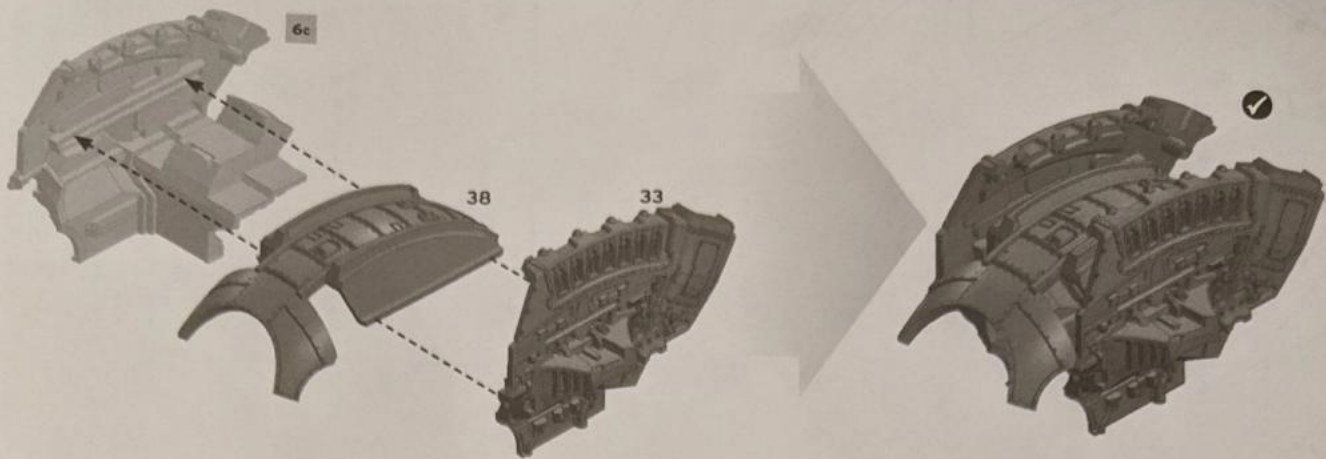

7B

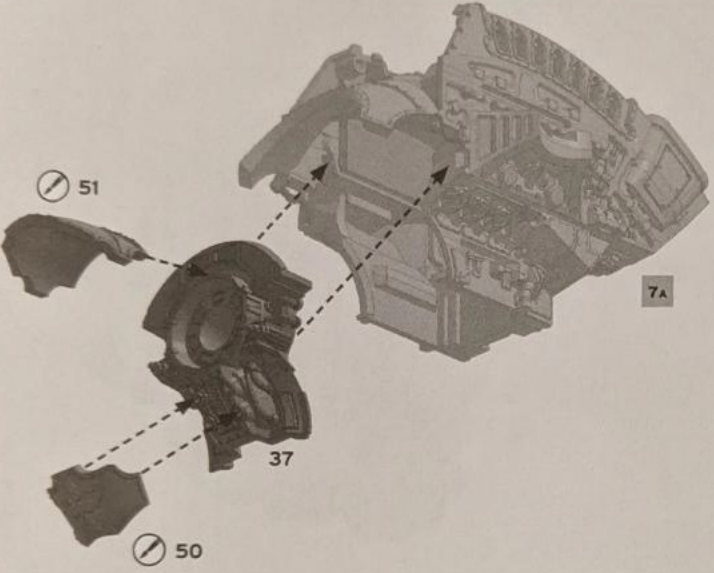

7C

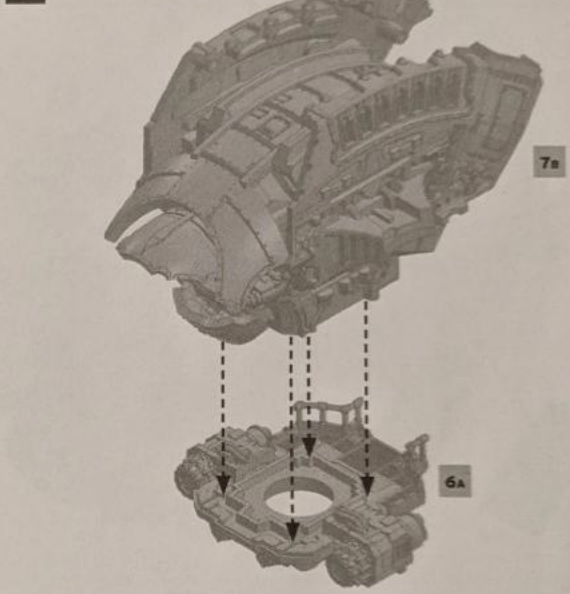

7D

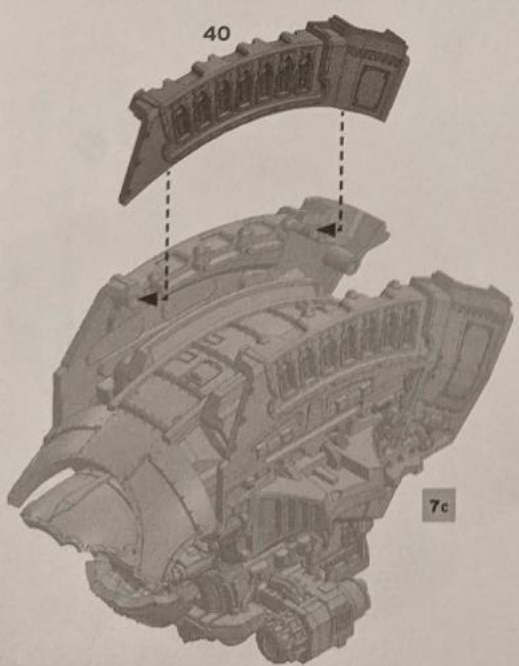

7E

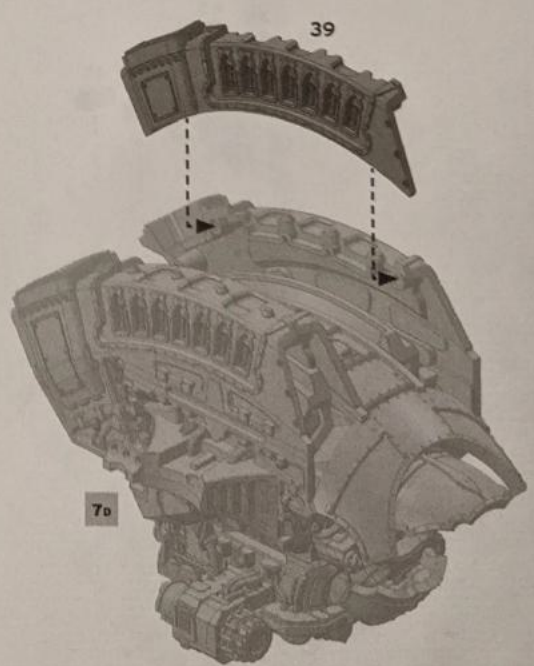

8A

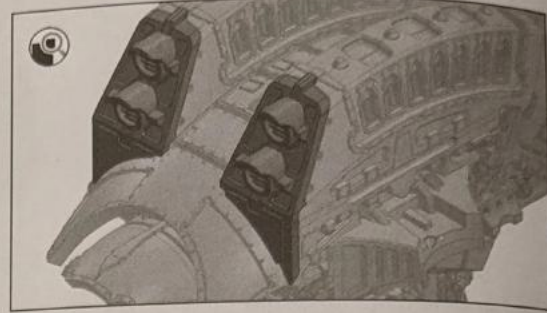
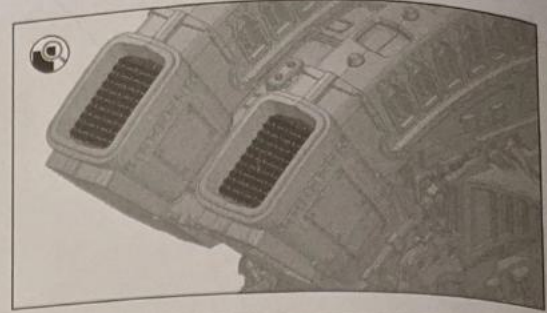
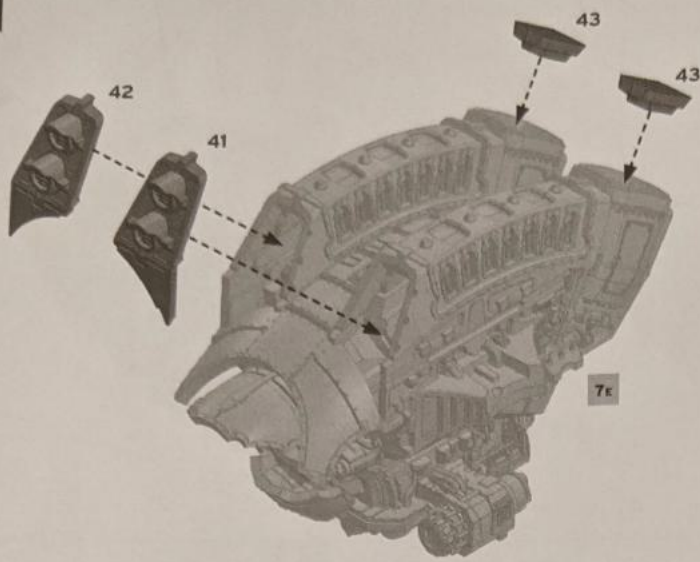

8B

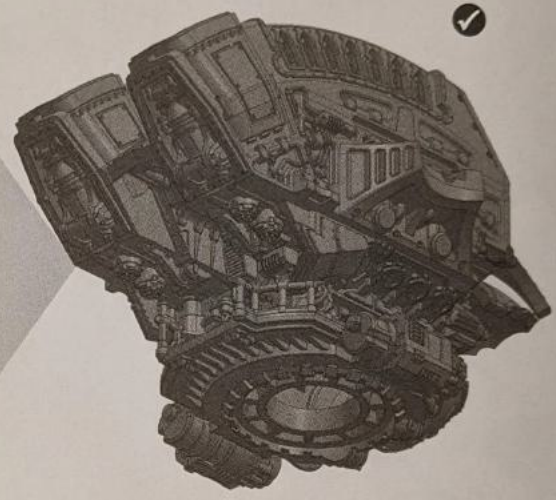
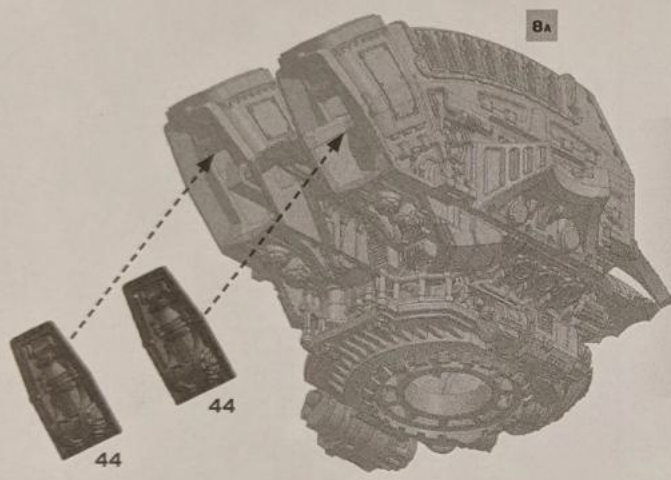

8c

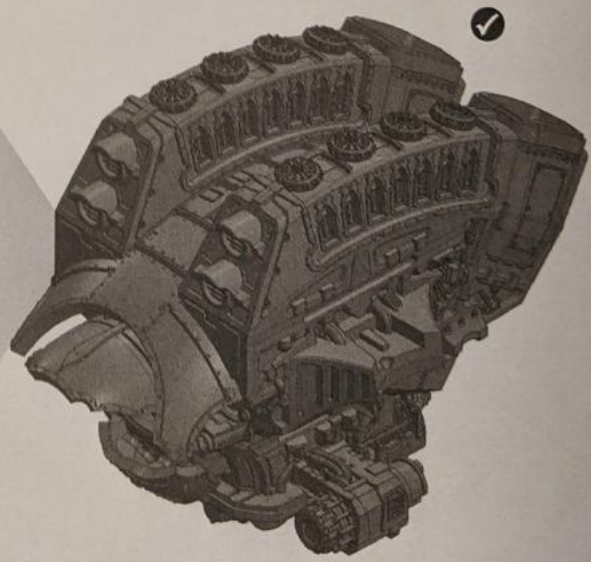
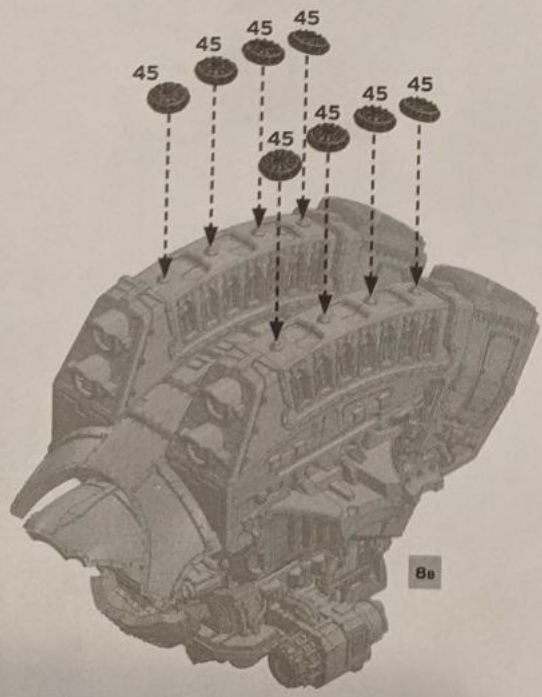

9A L



9B R

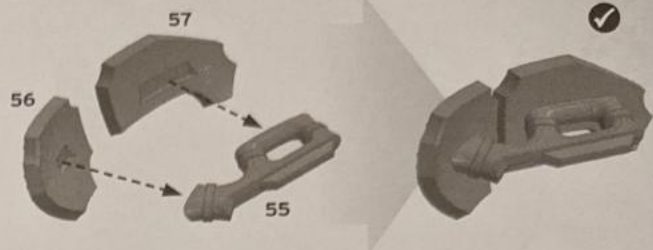

10A

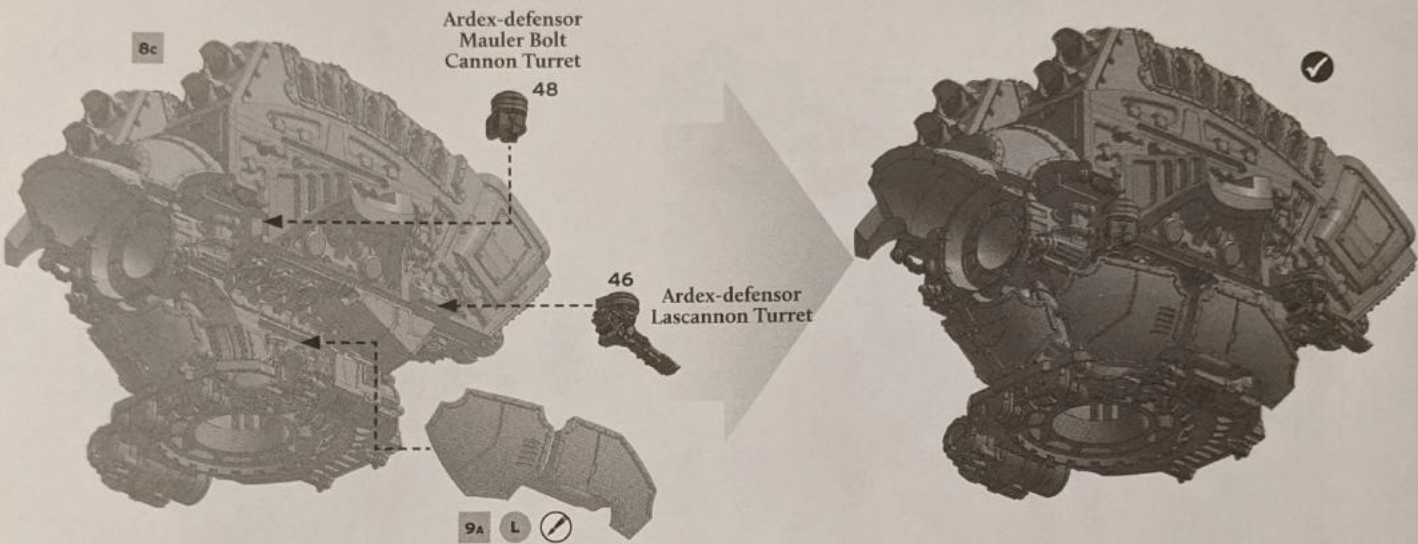

10B

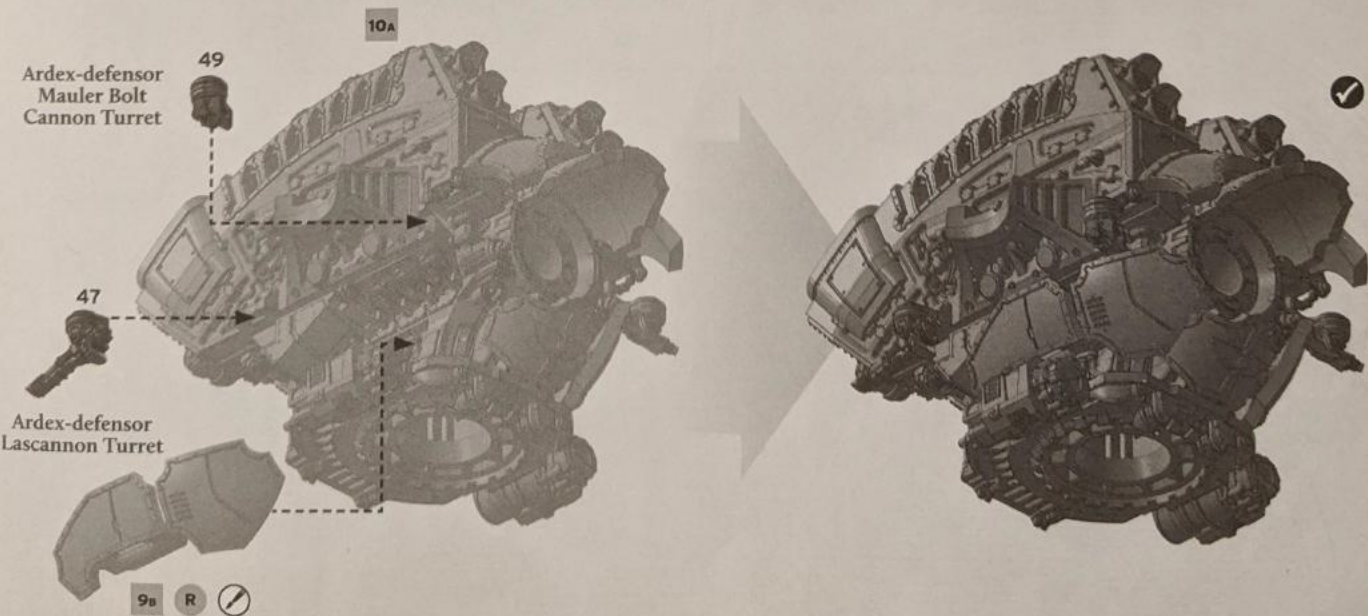



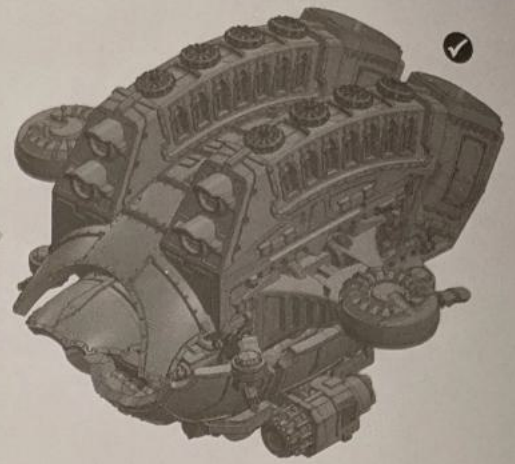
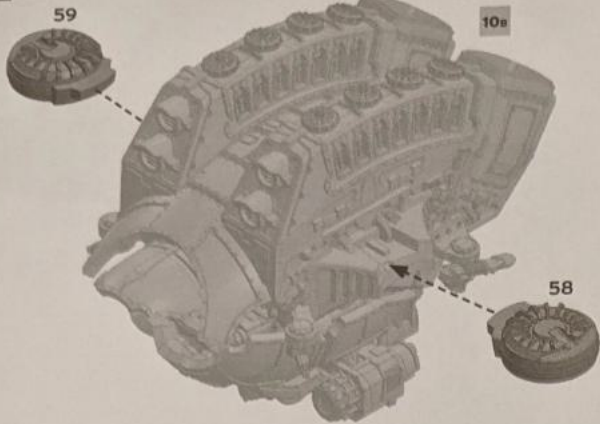



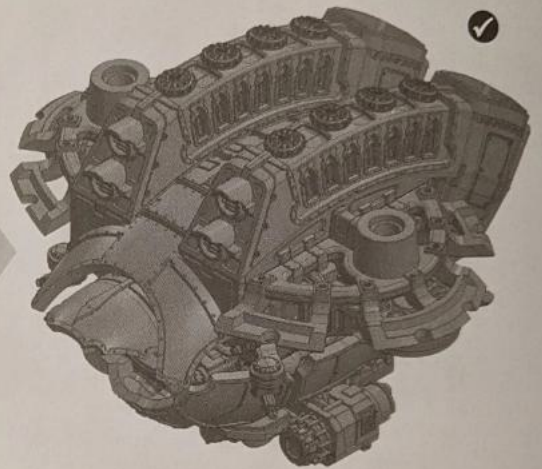
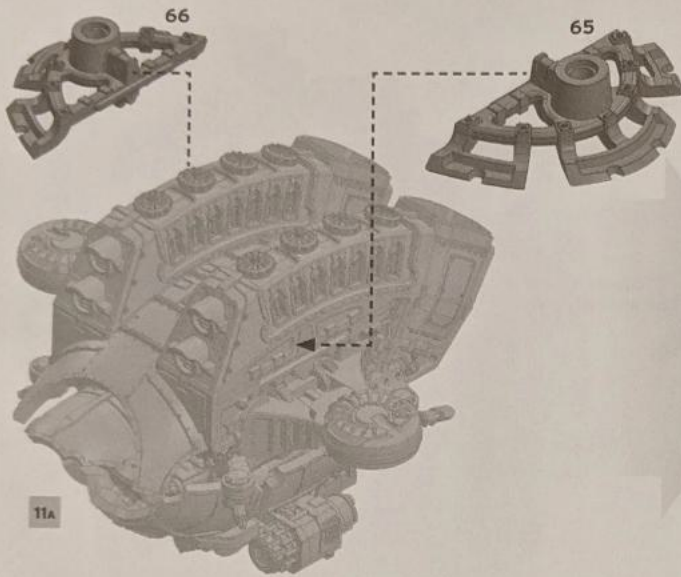





11A



11e



<p> Loyalist Armourials</p>   <p>71 68</p>	<p> Traitor Eye Of Horus Armourials</p>   <p>91 92</p>	<p></p>   <p>93 94</p>	<p></p>   <p>110 109</p>
---	--	--	--

12A

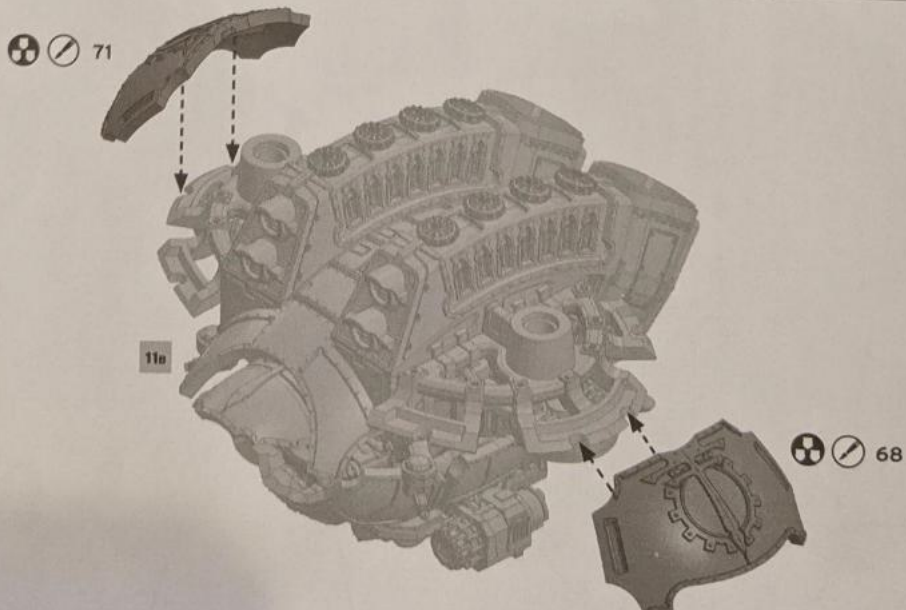

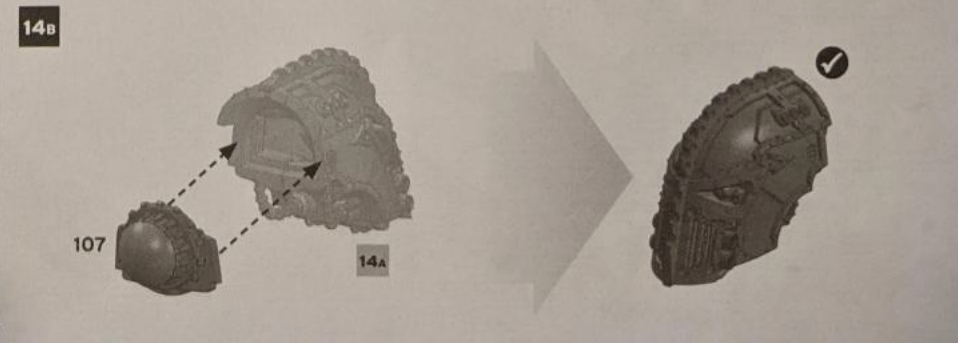
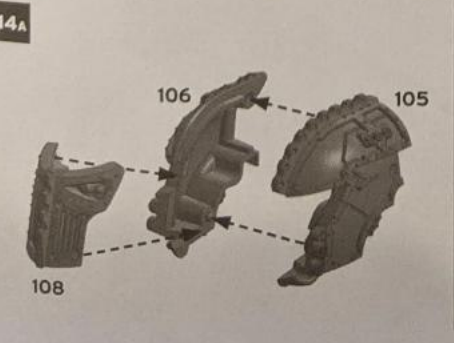
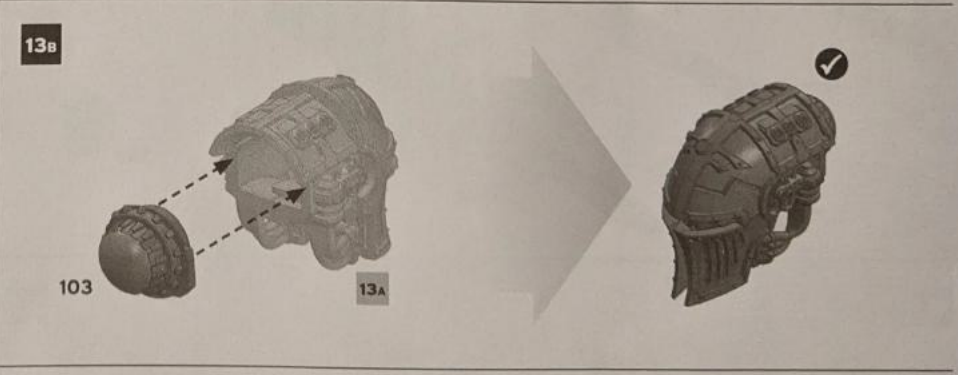
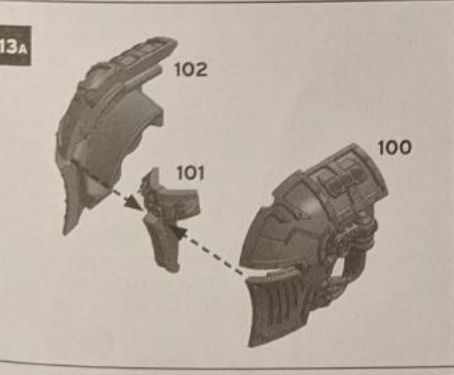
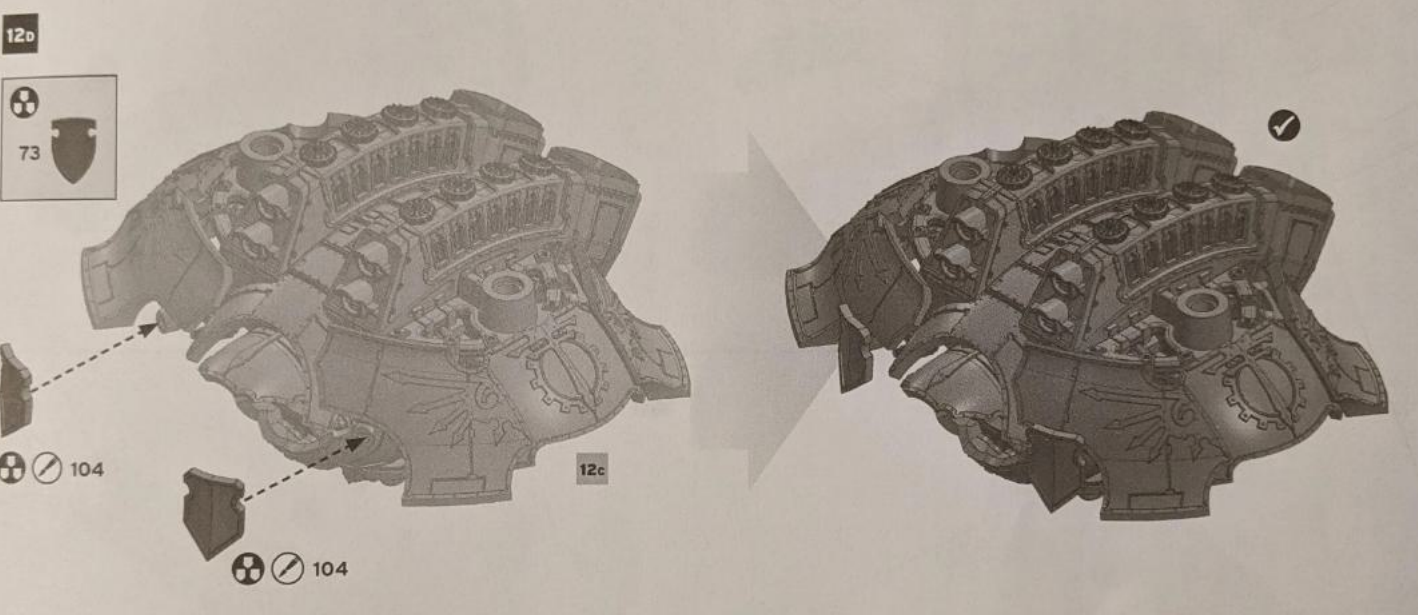
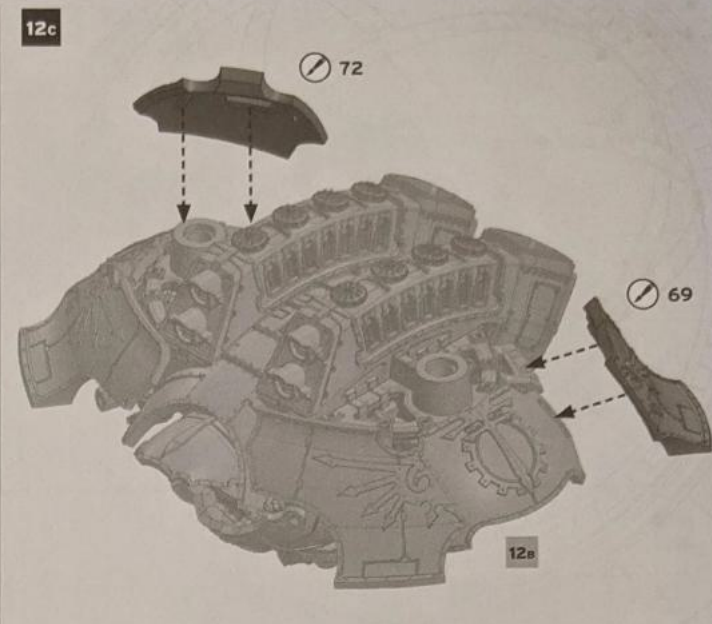
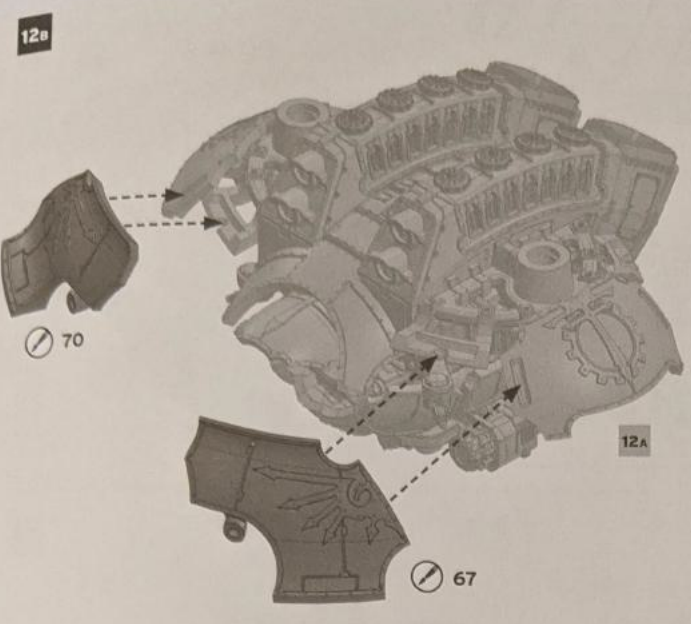

15A SUNFURY PLASMA ANNIHILATOR

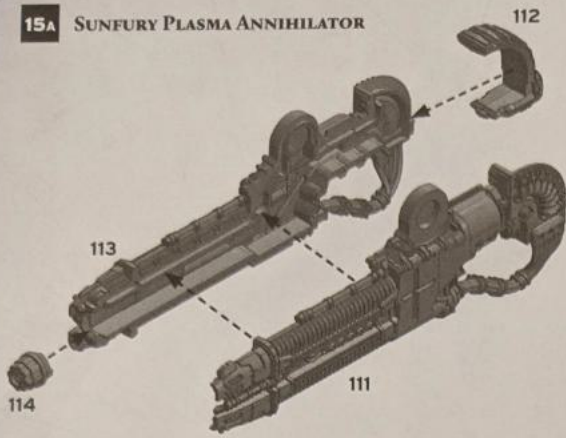

15B

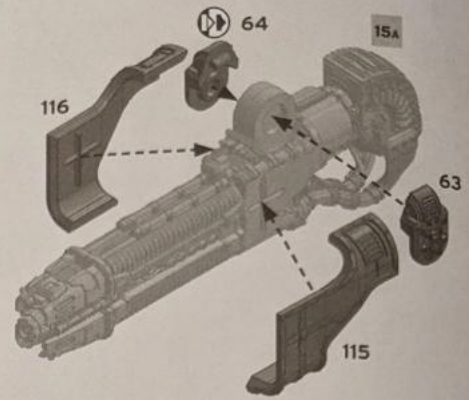

15C

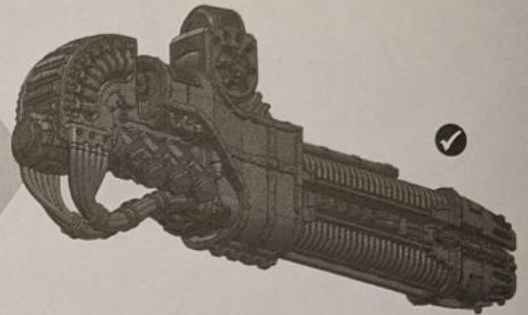
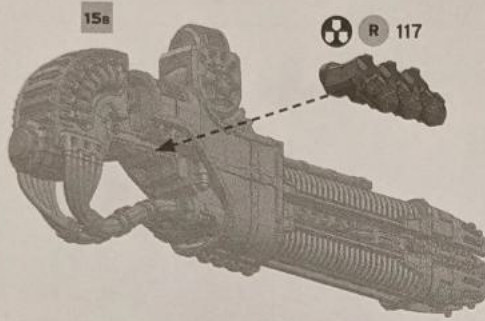

16A LASER BLASTERS

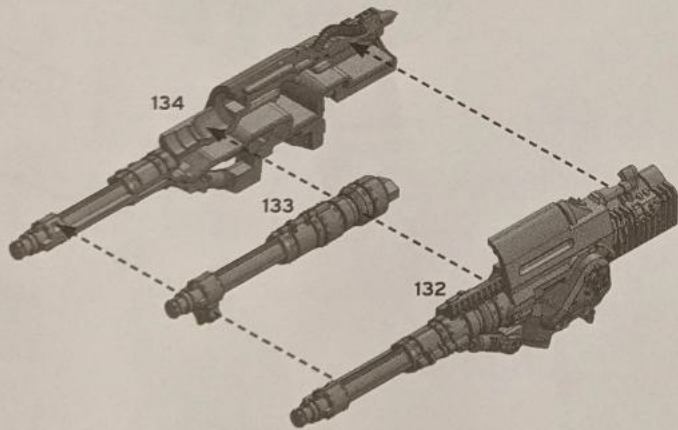

16B

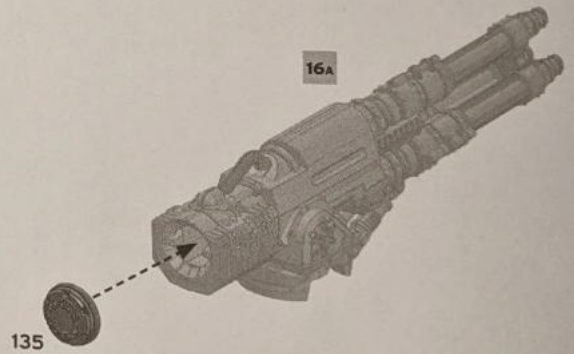

16C

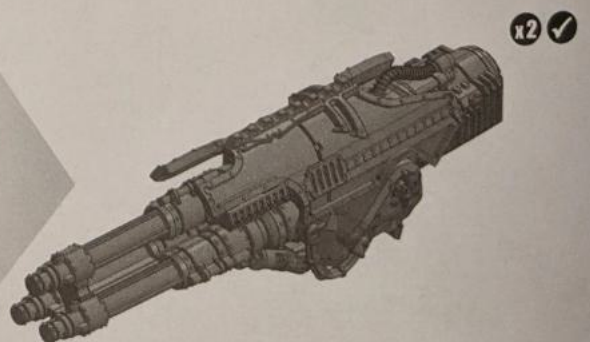
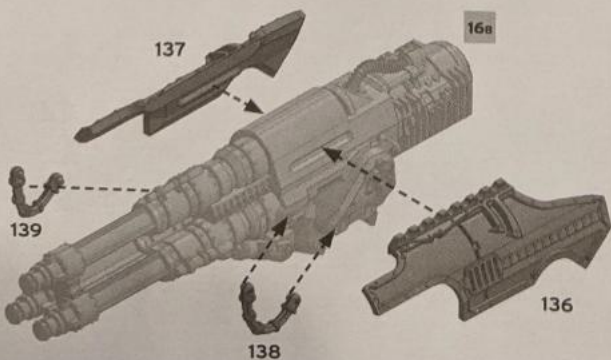

17A ARIOCH POWER CLAW

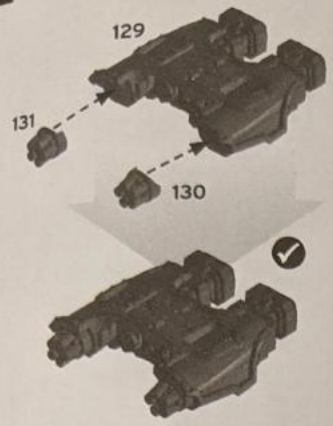

17B

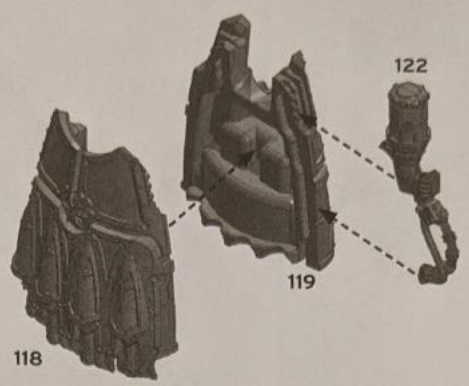

17C



17D

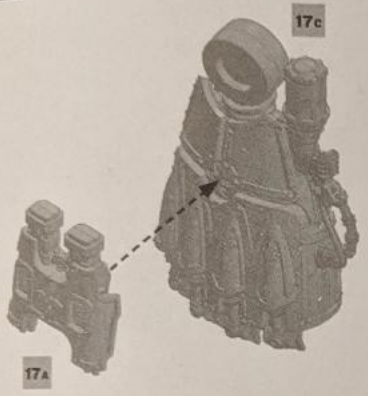

17E

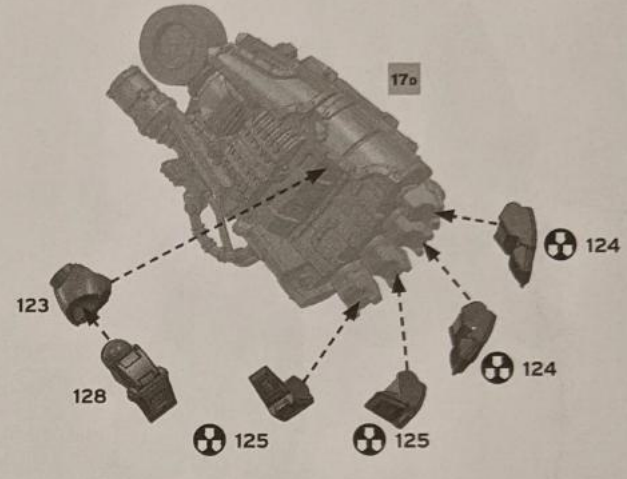
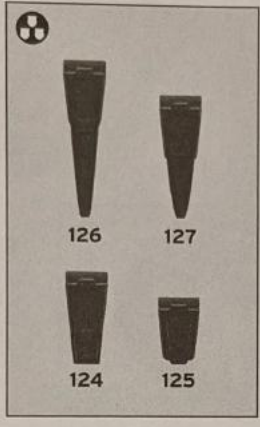

17F

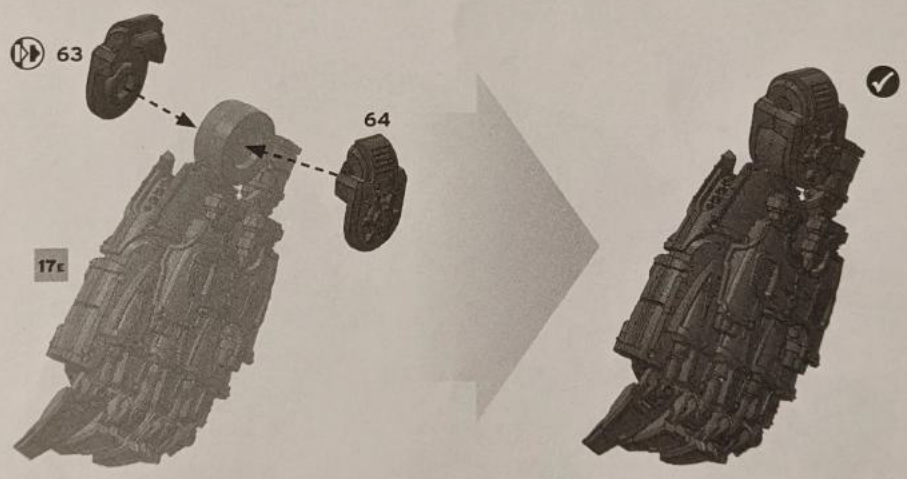

18A

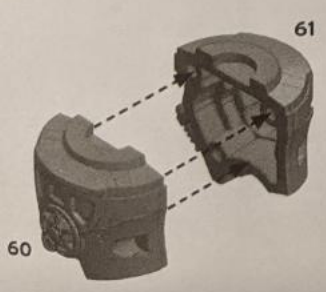

18B

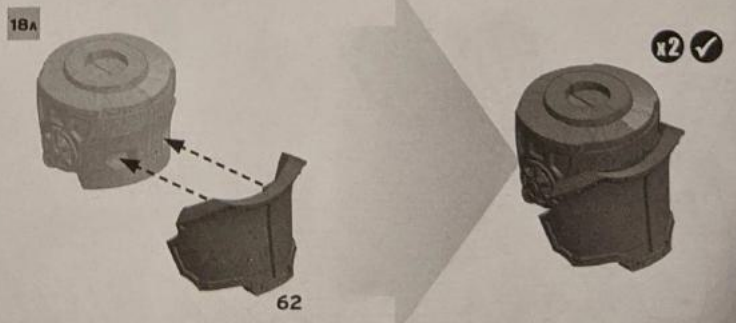

19

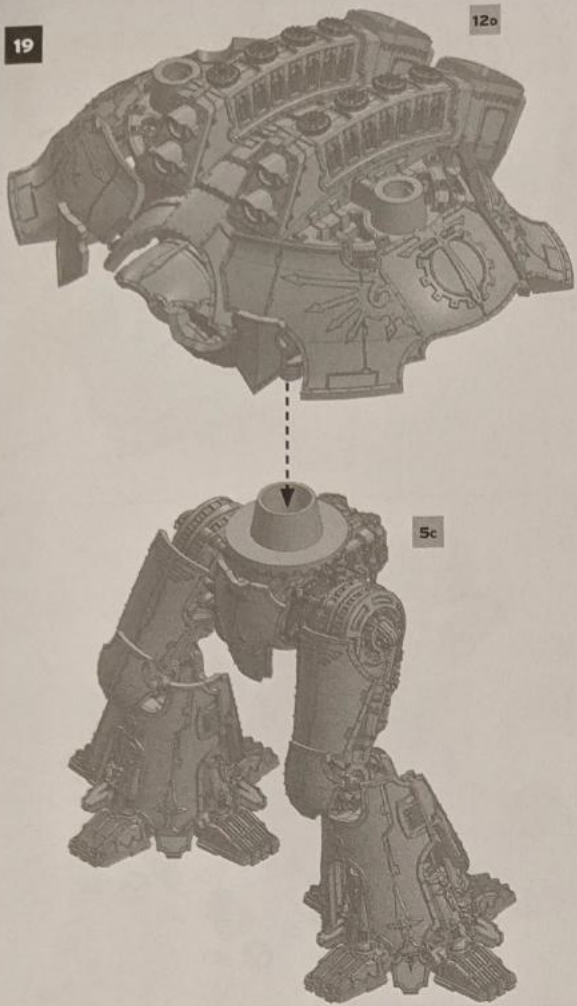

20

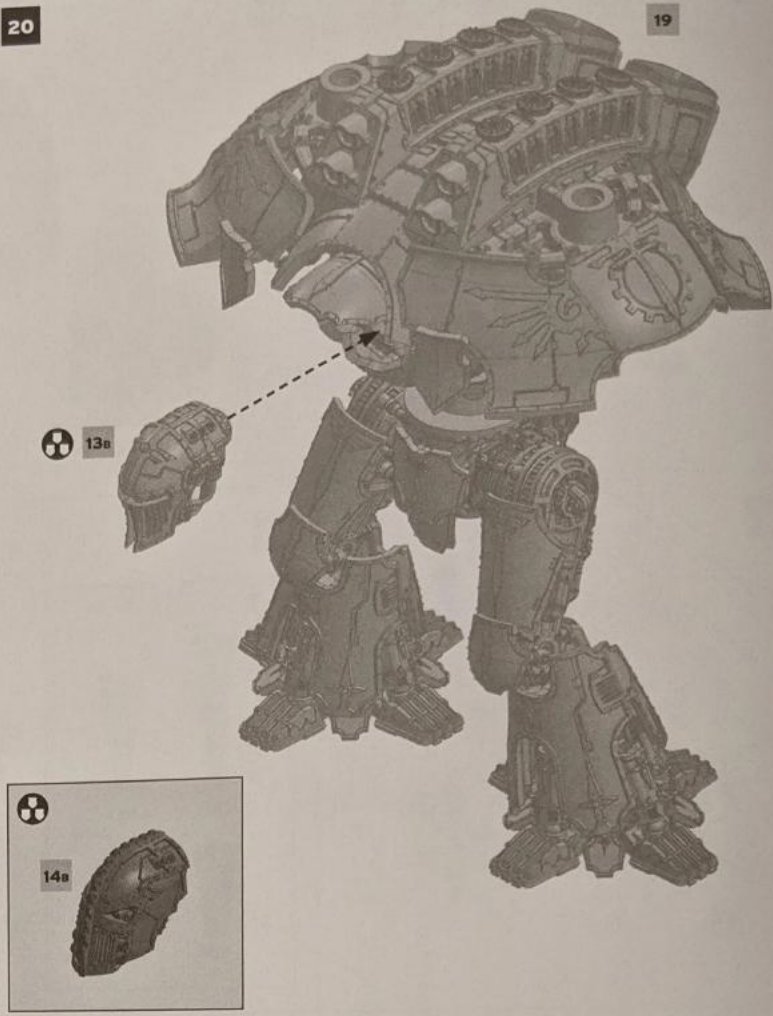

21

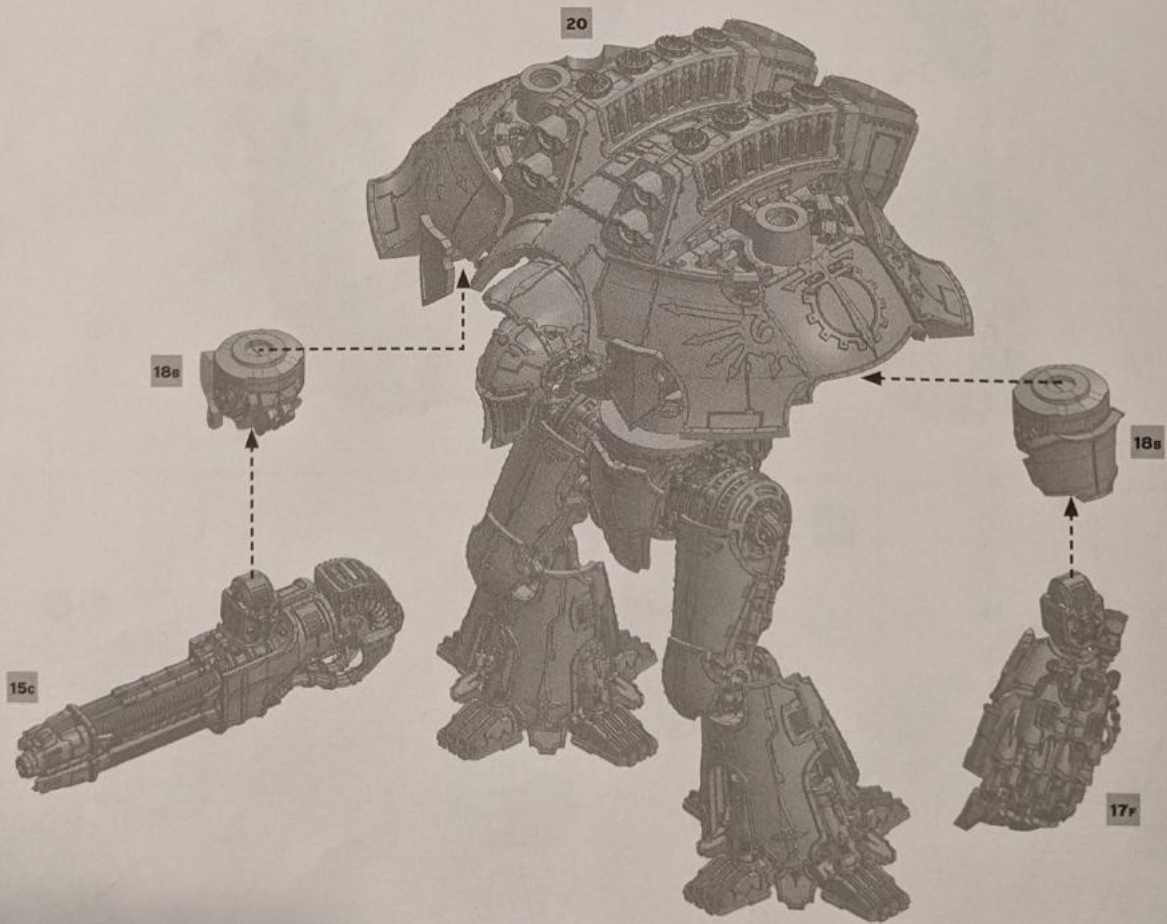

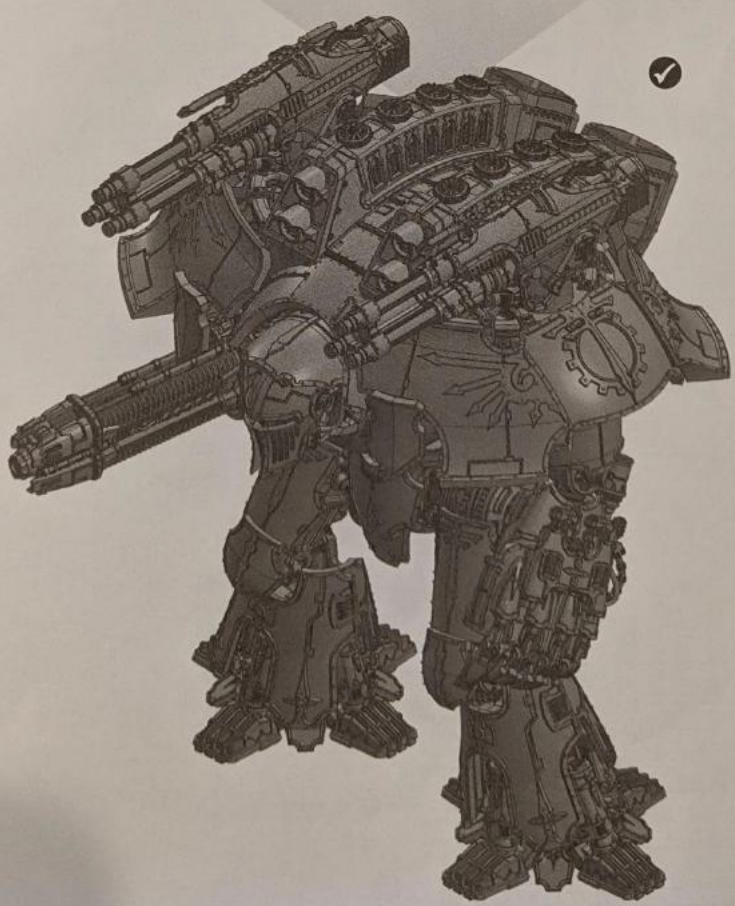
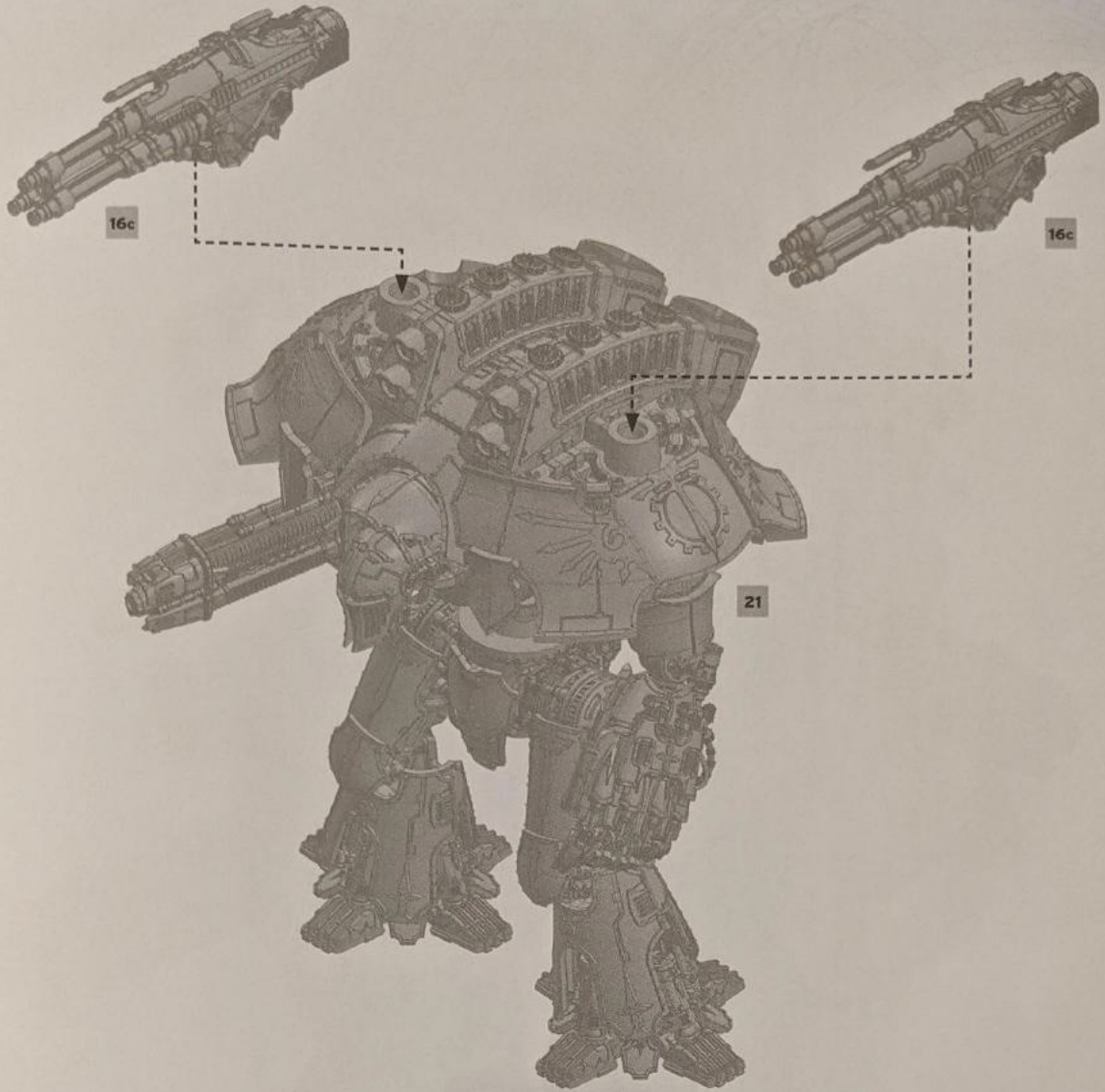

22

