



Free Downloads of Build Instructions,
Assembly Booklets & How To Guides

BuildInstructions.com

WARHAMMER
THE HORUS HERESY
- LEGIONS -
IMPERIALIS

LEGIONES ASTARTES SUPPORT

READ THIS FIRST | À LIRE EN PRIORITÉ | BITTE BEACHTEN | LEE ESTO PRIMERO | LEGGI PRIMA QUESTO | 最初にお読みください。| 请优先阅读

ENG BEFORE ASSEMBLING YOUR MINIATURES, PLEASE READ THROUGH THE INSTRUCTIONS IN THIS BOOKLET CAREFULLY.

A pair of plastic cutters is required to remove the plastic components in this kit from their frame. We advise using a mouldline scraping tool to clean up the parts. To assemble your model you will need plastic glue. Games Workshop sells Citadel Fine Detail Cutters, Citadel Mouldline Removers and Citadel Plastic Glue, but does not recommend these products for use by children under the age of 16 without adult supervision.

FRE AVANT D'ASSEMBLER VOS FIGURINES, VEUILLEZ LIRE ATTENTIVEMENT LES INSTRUCTIONS DE CE LIVRET.

Une pince coupante est requise pour détacher chaque élément de sa grappe plastique. Nous vous recommandons l'utilisation d'un ébarboir pour gratter chaque élément. Pour l'assemblage, vous aurez besoin de colle plastique. Games Workshop commercialise les Pinces de Précision Citadel, l'Ébarboir Citadel et la Colle Plastique Citadel, mais n'en recommande pas l'utilisation aux enfants de moins de 16 ans sans la supervision d'un adulte.

SPA POR FAVOR, LEE CUIDADOSAMENTE ESTE LIBRETO DE INSTRUCCIONES ANTES DE EMPEZAR A MONTAR LAS MINIATURAS.

Te harán falta unas tenazas para plástico a fin de separar las piezas de la matriz. También aconsejamos una herramienta para quitar rebabas a fin de limpiar cada pieza. Para montar la miniatura necesitarás pegamento para plástico. Games Workshop vende Tenazas de detalle superfino, Quitarrebabas Citadel y Pegamento para plástico Citadel, pero no recomienda estos productos a menores de 16 años sin supervisión de un adulto.

GER VOR DEM ZUSAMMENBAU DER MINIATUREN BITTE DIE ANWEISUNGEN IN DIESER ANLEITUNG AUFMERKSAM DURCHLESEN.

Du benötigst einen Kunststoffseitschneider, um die Kunststoffbauteile aus dem Gussrahmen herauszutrennen. Außerdem empfehlen wir, die Bauteile mit einem Gussgratentferner zu säubern. Um dein Modell zusammenzubauen, benötigst du Kunststoffkleber. Games Workshop bietet Präzisions-Seitschneider und Gussgratentferner von Citadel sowie Citadel-Kunststoffkleber an, empfiehlt aber, dass Kinder unter 16 Jahren diese nur unter Aufsicht eines Erwachsenen benutzen.

ITA PRIMA DI ASSEMBLARE LE TUE MINIATURE LEGGI ATTENTAMENTE TUTTE LE ISTRUZIONI DI QUESTO LIBRETTO.

Sono necessarie un paio di tronchesine per plastica per staccare i componenti dai loro sprue. Consigliamo di usare un attrezzo apposito per pulire i componenti. Per assemblare il modello avrai bisogno di colla per plastica. Games Workshop vende Tronchesine di ultraprecisione Citadel, Attrezzo per ripulire Citadel e Colla per plastica Citadel, ma non consiglia questi prodotti ad un pubblico minore di 16 anni senza la supervisione di un adulto.

日本語 始まる前に必ず説明書をお読みください。本キット内のフレームからプラスチックパーツを切り離すためには、ニッパーが必要です。パーツのモールドを平らにするには、専用ツールのご使用をお勧めいたします。本キットの組み立てには、プラ用接着剤が必要です。ゲームズワークショップはスーパー・ファインディテール・カッター、シタデル・プラスチックグレー、シタデル・モールドラインリムーバーを販売しておりますが、16歳以下の子供が大人の監督なしにこれらの道具を使用されることをお勧めしません。

中文 在组装您的微缩模型之前，请仔细阅读本手册中的说明。

您需要一把模型剪将塑料部件从板件上剪下来。我们建议使用模线刮刀来处理零件。组装时您还需要用到塑料胶水。您可以从 Games Workshop 处购买到 Citadel 精密剪钳、Citadel 模线刮刀和 Citadel 塑料胶水，但 16 岁以下儿童不得在没有成年人监护的情况下使用这些产品。

EXPLANATION OF SYMBOLS | EXPLICATION DES SYMBOLES
EXPLICACIÓN DE SÍMBOLOS | ERLÄUTERUNG DER SYMBOLE
LEGENDA DEI SIMBOLI | アイコン解説 | 符号说明

- ✔
- Stage complete
 - Étape terminée
 - Paso completado
 - Schritt abgeschlossen
 - Fase completa
 - このステージの完成
 - 完成

16+



Citadel Plastic Glue
Colle plastique liquide Citadel
Pegamento para plástico fluido
Citadel-Kunststoffkleber
Colla per plastica fluida Citadel
シタデルプラスチック接着剤流し込みタイプ
Citadel 塑料灌缝粘胶

Super Fine Detail Cutters
Pince Coupante de Précision
Tenazas de detalle superfino
PRÄZISIONS-SEITENSCHNEIDER
Tronchesine di ultraprecisione
スーパー・ファインディテール・カッター
精密剪钳

Mouldline Remover
Ébarboir
Quita-rebabas
Gussgratentferner
Attrezzo per ripulire
モールドライン・リムーバー
合模线刮刀

LEVIATHAN SIEGE DREADNOUGHT WITH MELTA LANCE

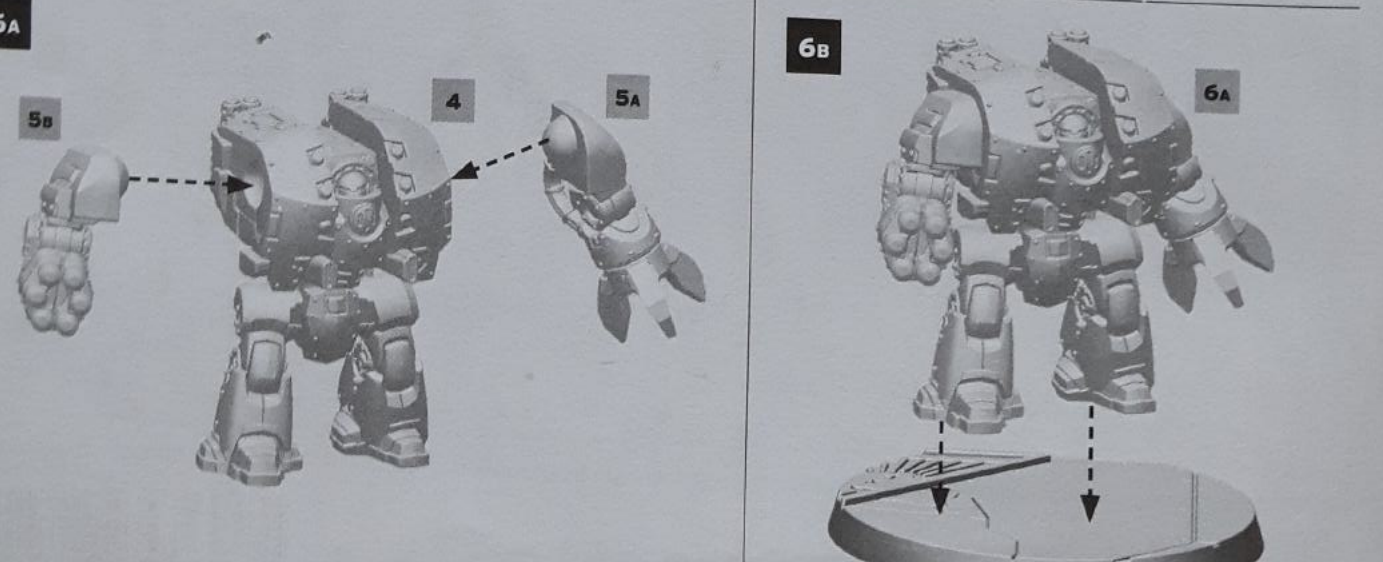
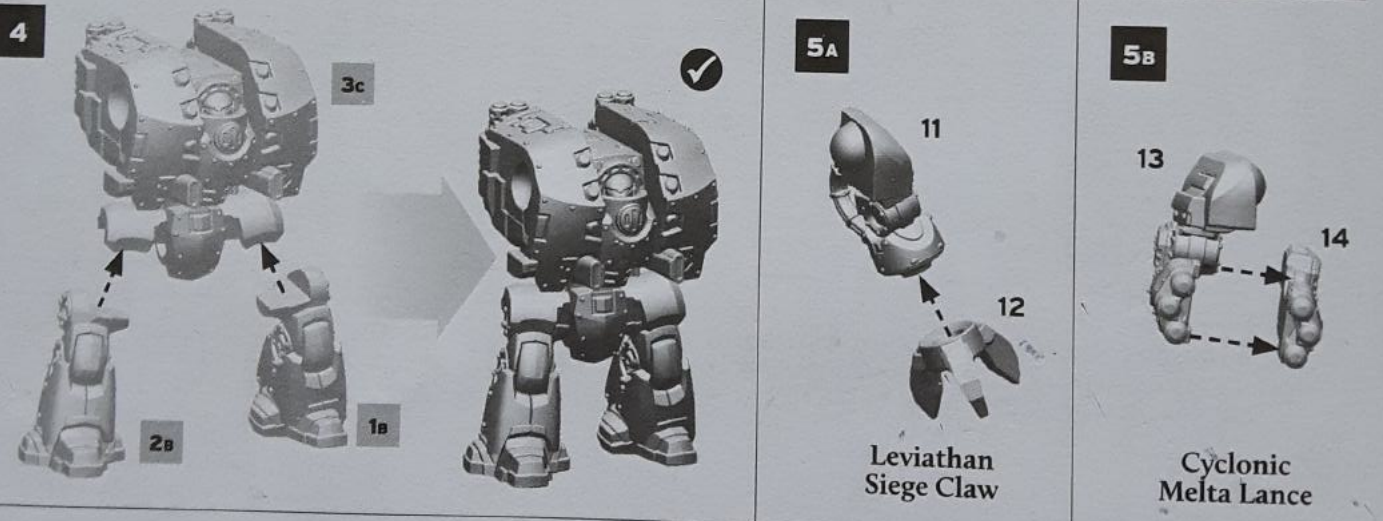
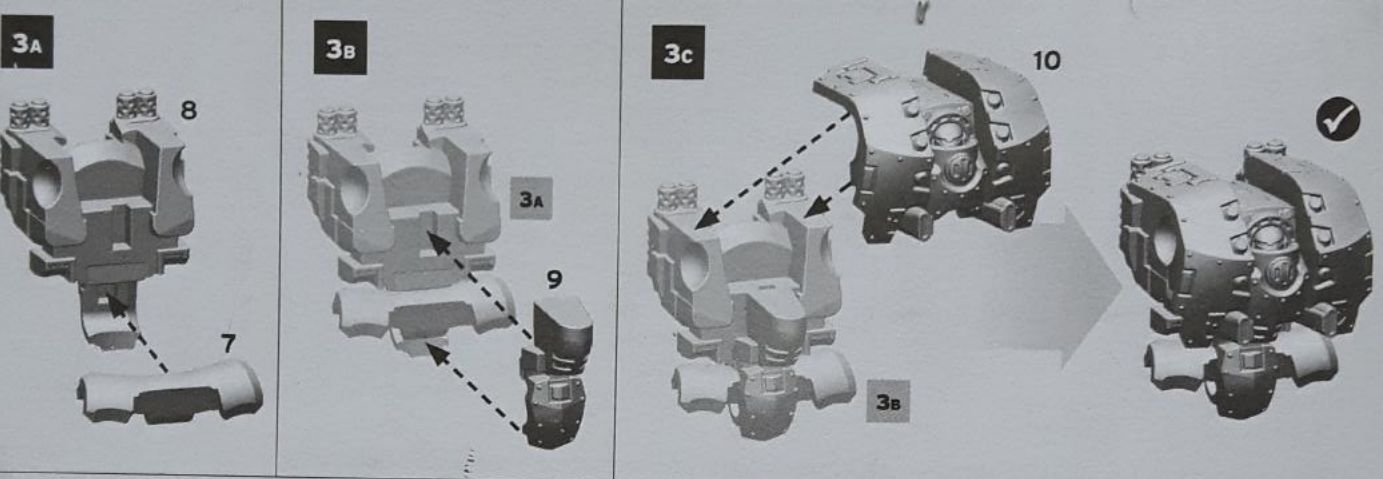
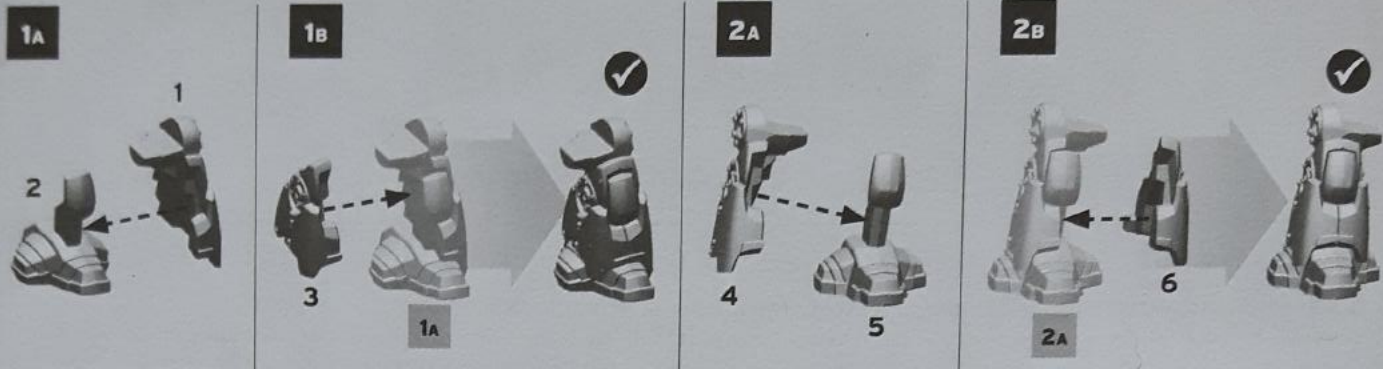

LEVIATHAN SIEGE DREADNOUGHT WITH STORM CANNON

7A

15

16

7B

17

7A

8A

18

19

8B

20

8A

9A

21

22

9B

23

9A

9C

24

9B

10

8B

7B

9C

11A

27

28

Leviathan
Siege Claw

11B

25

26

Leviathan
Storm Cannon

12A

11A

10

11B

12B

12A

DEREDEO DREADNOUGHT WITH ANVILUS AUTOCANNON BATTERY

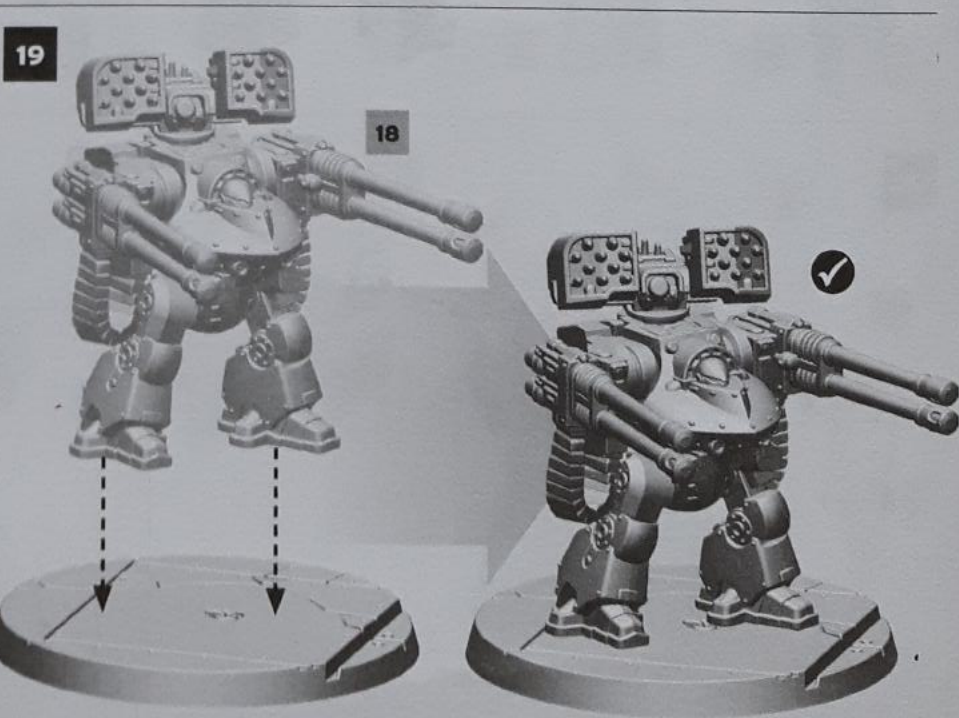
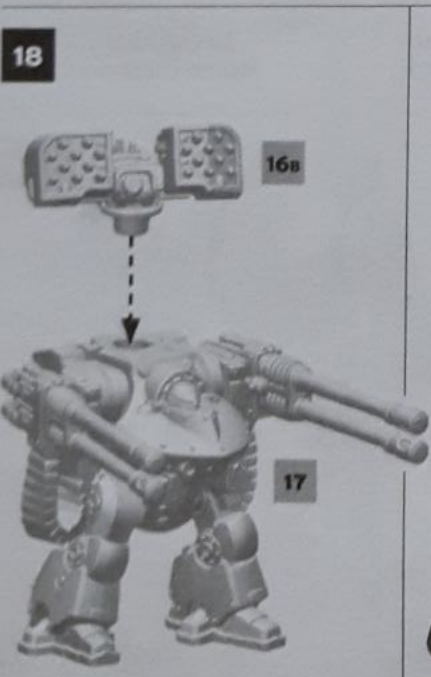
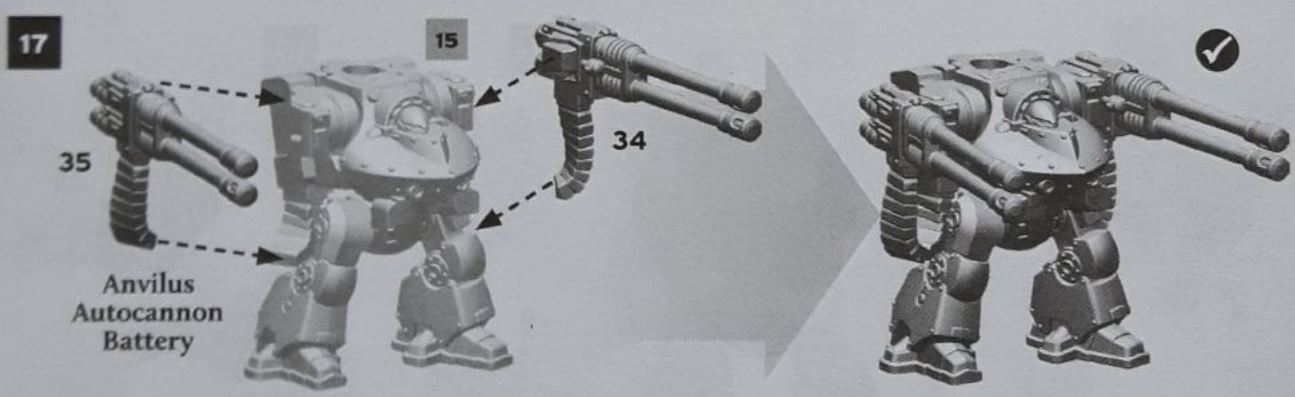
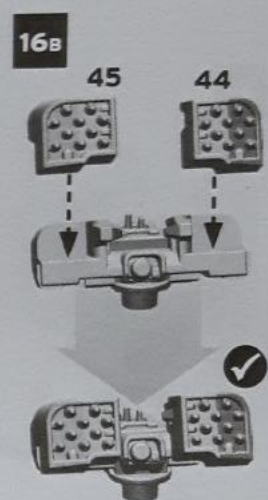
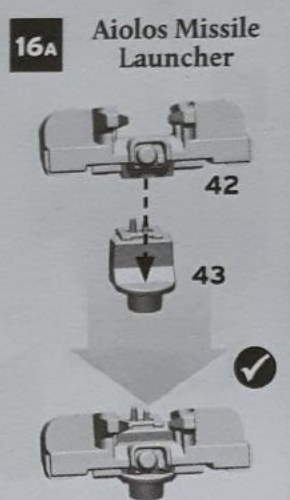
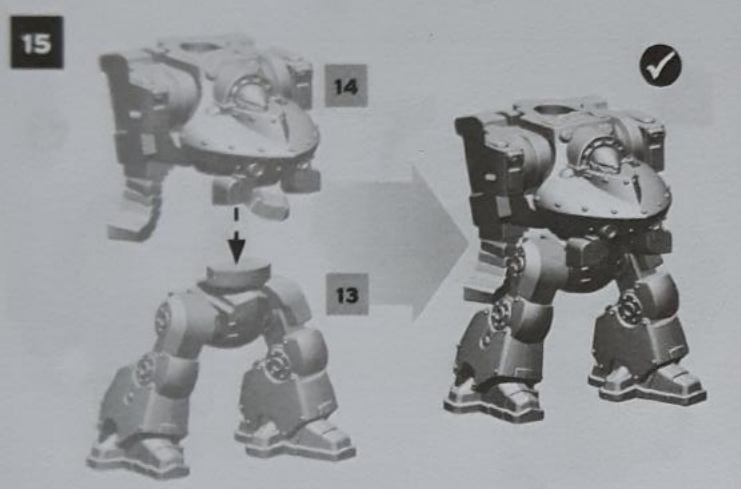
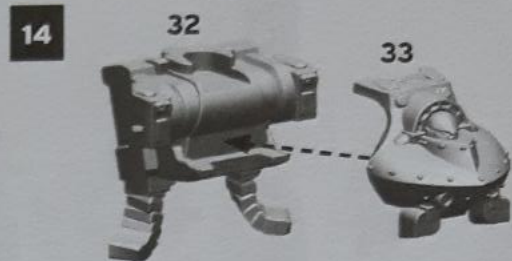
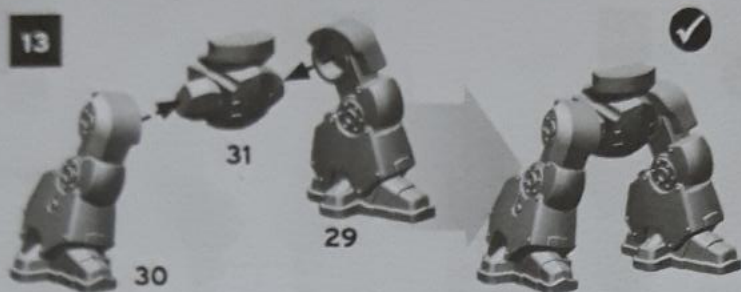

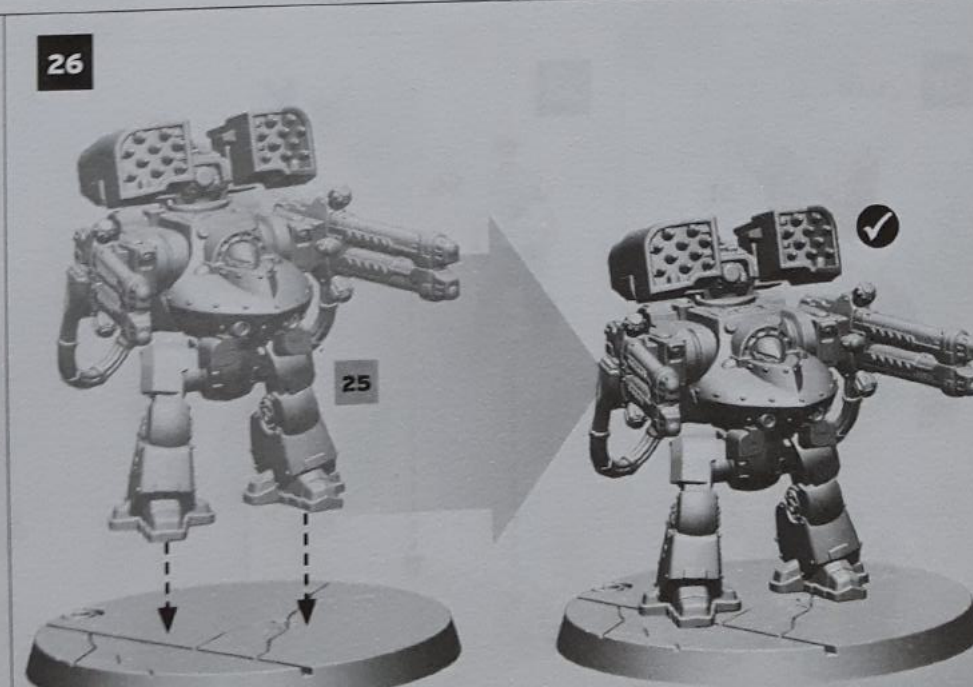
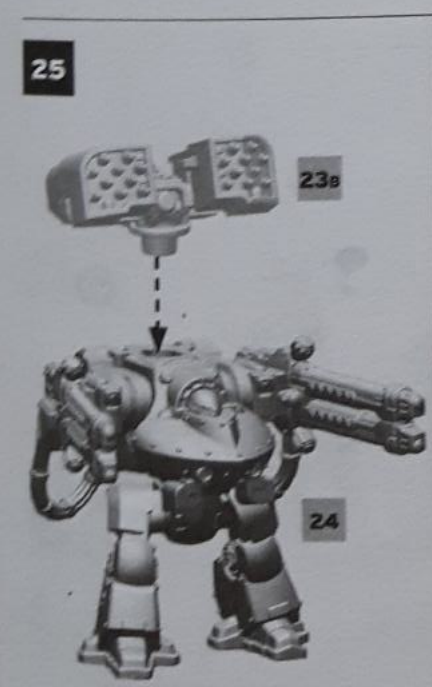
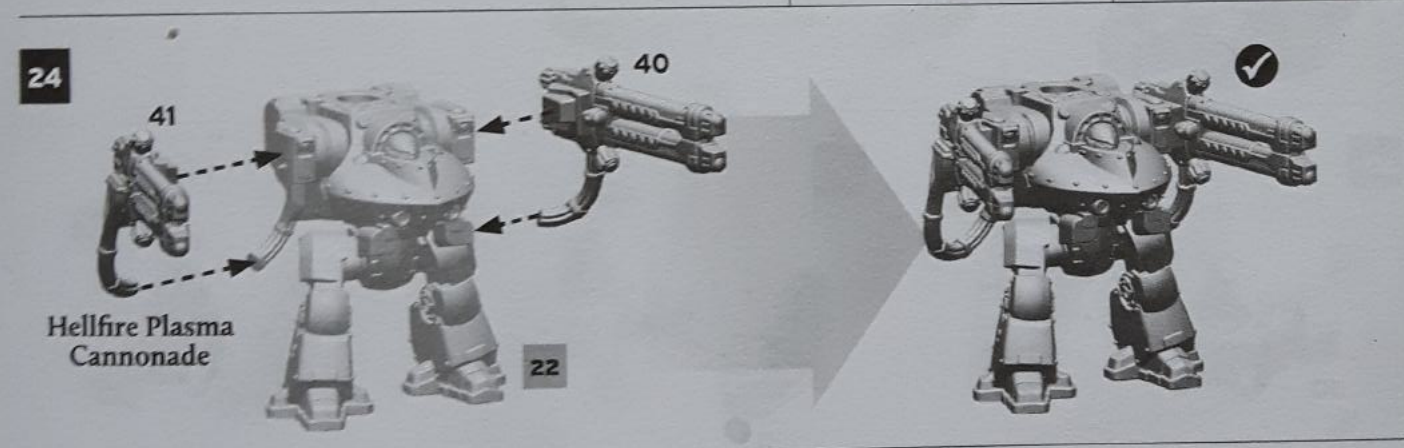
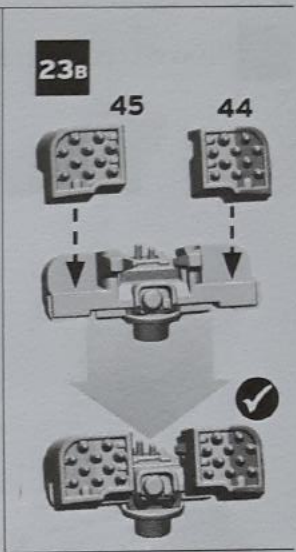
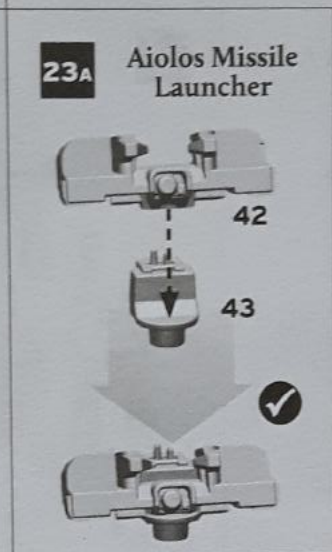
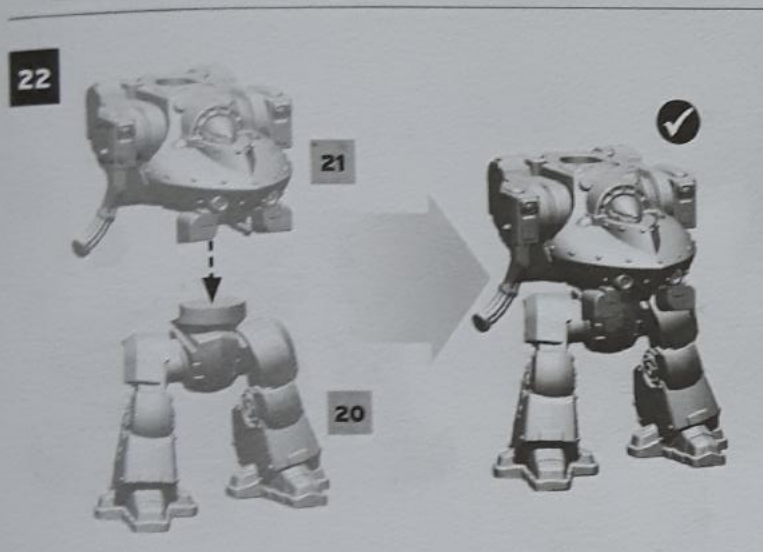
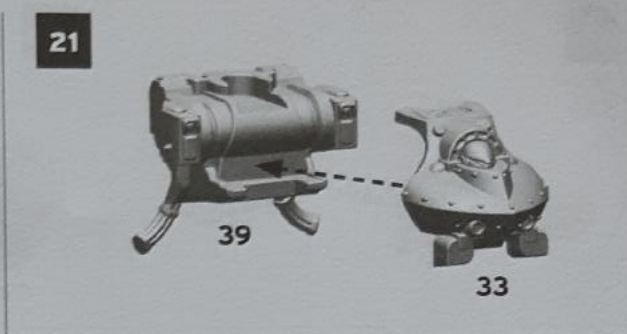
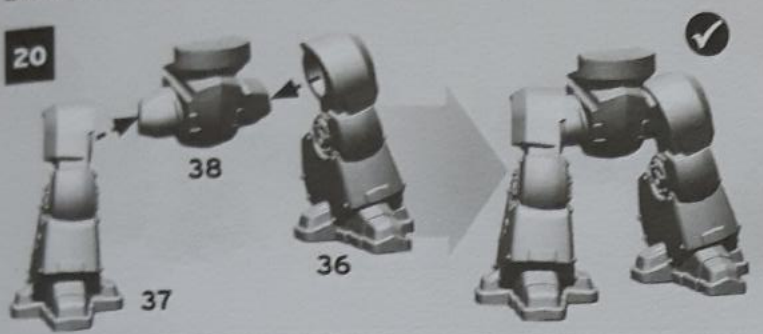

LEGION RAPIER

27A

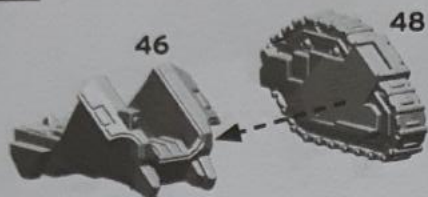

27B



28 LASER DESTROYER ARRAY

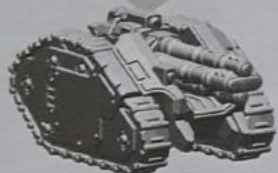

29

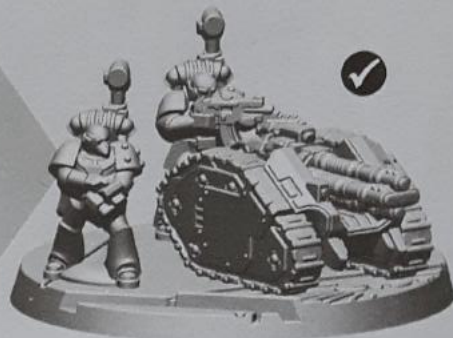

30A



30B



31 QUAD LAUNCHER



32

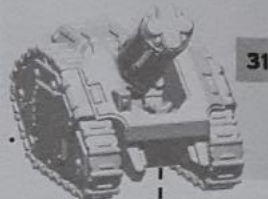
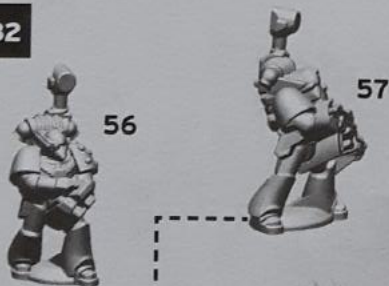

LEGION TARANTULA

33

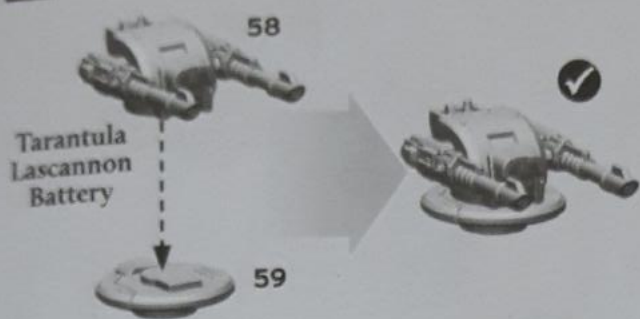

34

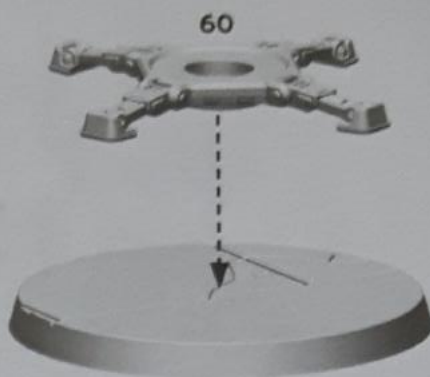

35

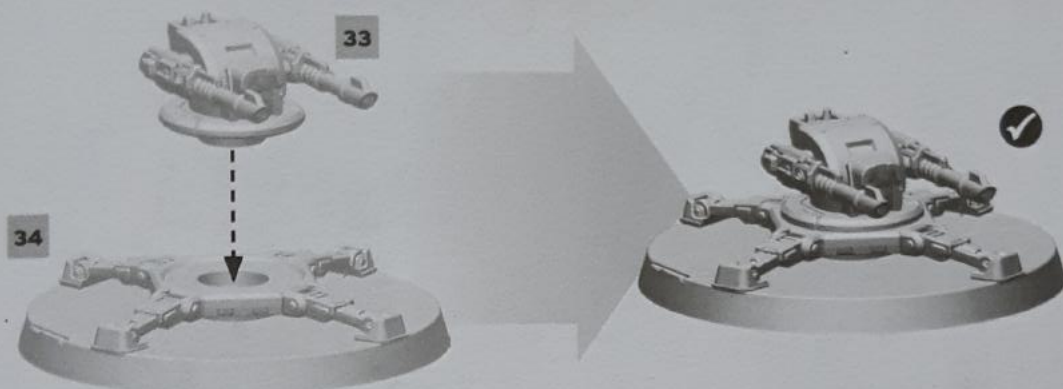

36A



36B

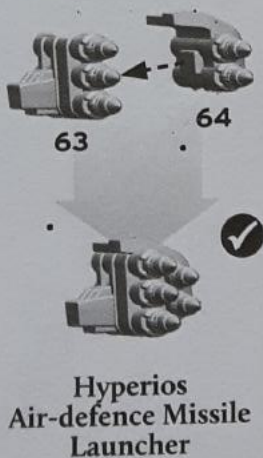

36c



36d

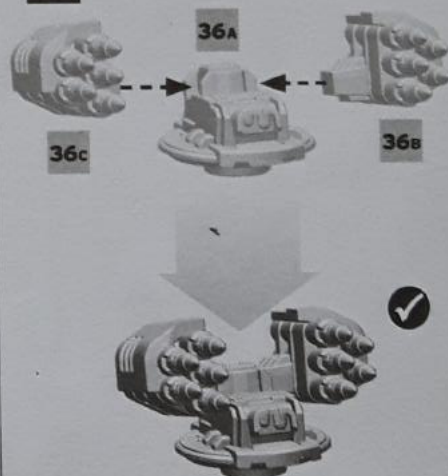

37

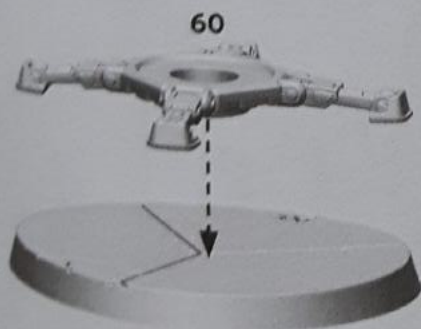

38

