



Free Downloads of Build Instructions,  
Assembly Booklets & How To Guides

**BuildInstructions.com**

WARHAMMER  
THE HORUS HERESY  
- LEGIONS -  
IMPERIALIS

LEGIONES ASTARTES BATTLE GROUP



READ THIS FIRST | À LIRE EN PRIORITÉ | BITTE BEACHTE | LEE ESTO PRIMERO | LEGGI PRIMA QUESTO | 最初にお読みください。| 请优先阅读

**ENG** BEFORE ASSEMBLING YOUR MINIATURES, PLEASE READ THROUGH THE INSTRUCTIONS IN THIS BOOKLET CAREFULLY.

A pair of plastic cutters is required to remove the plastic components in this kit from their frame. We advise using a mouldline scraping tool to clean up the parts. To assemble your model you will need plastic glue. Games Workshop sells Citadel Fine Detail Cutters, Citadel Mouldline Removers and Citadel Plastic Glue, but does not recommend these products for use by children under the age of 16 without adult supervision.

**FRE** AVANT D'ASSEMBLER VOS FIGURINES, VEUILLEZ LIRE ATTENTIVEMENT LES INSTRUCTIONS DE CE LIVRET.

Une pince coupante est requise pour détacher chaque élément de sa grappe plastique. Nous vous recommandons l'utilisation d'un ébarboir pour gratter chaque élément. Pour l'assemblage, vous aurez besoin de colle plastique. Games Workshop commercialise les Pinces de Précision Citadel, l'Ébarboir Citadel et la Colle Plastique Citadel, mais n'en recommande pas l'utilisation aux enfants de moins de 16 ans sans la supervision d'un adulte.

**SPA** POR FAVOR, LEE CUIDADOSAMENTE ESTE LIBRETO DE INSTRUCCIONES ANTES DE EMPEZAR A MONTAR LAS MINIATURAS.

Te harán falta unas tenazas para plástico a fin de separar las piezas de la matriz. También aconsejamos una herramienta para quitar rebabas a fin de limpiar cada pieza. Para montar la miniatura necesitarás pegamento para plástico. Games Workshop vende Tenazas de detalle superfino, Quitarrebabas Citadel y Pegamento para plástico Citadel, pero no recomienda estos productos a menores de 16 años sin supervisión de un adulto.

**GER** VOR DEM ZUSAMMENBAU DER MINIATUREN BITTE DIE ANWEISUNGEN IN DIESER ANLEITUNG AUFMERKSAM DURCHLESEN.

Du benötigst einen Kunststoffseitenschneider, um die Kunststoffbauteile aus dem Gussrahmen herauszutrennen. Außerdem empfehlen wir, die Bauteile mit einem Gussgratentferner zu säubern. Um dein Modell zusammenzubauen, benötigst du Kunststoffkleber. Games Workshop bietet Präzisions-Seitenschneider und Gussgratentferner von Citadel sowie Citadel-Kunststoffkleber an, empfiehlt aber, dass Kinder unter 16 Jahren diese nur unter Aufsicht eines Erwachsenen benutzen.

**ITA** PRIMA DI ASSEMBLARE LE TUE MINIATURE LEGGI ATTENTAMENTE TUTTE LE ISTRUZIONI DI QUESTO LIBRETTO.

Sono necessarie un paio di tronchesine per plastica per staccare i componenti dai loro sprue. Consigliamo di usare un attrezzo apposito per pulire i componenti. Per assemblare il modello avrai bisogno di colla per plastica. Games Workshop vende Tronchesine di ultraprecisione Citadel. Attrezzo per ripulire Citadel e Colla per plastica Citadel, ma non consiglia questi prodotti ad un pubblico minore di 16 anni senza la supervisione di un adulto.

**日本語** 始まる前に必ず説明書をお読みください。

本キット内のフレームからプラスチックパーツを切り離すためには、ニッパーが必要です。パーツのモールドを平らにするには、専用ツールの使用をお勧めいたします。本キットの組み立てには、プラ用接着剤が必要です。ゲームズワークショップはスーパー・ファインディテール・カッター、シタデル・プラスチックグレー、シタデル・モールドラインリムーバーを販売しておりますが、16歳以下の子供が大人の監督なしにこれらの道具を使用されることをお勧めしません。

**中文** 在组装您的微型模型之前，请仔细阅读本手册中的说明。

您需製一把模型剪將塑料部件從板件上剪下來。我們建議使用橫線刮刀來處理零件。組裝時你還需要用到塑料黏水。你可以從 Games Workshop 處購買到 Citadel 精密剪鉗、Citadel 橫線刮刀和 Citadel 塑料黏水，但 16 歲以下兒童不得在沒有成年人監護的情況下使用這些產品。

16+

Citadel Plastic Glue  
Colle plastique Citadel  
Pegamento para plástico Citadel  
Citadel-Kunststoffkleber  
Colla per plastica Citadel  
シタデルプラスチック接着剤流し込みタイプ  
Citadel 塑料灌缝粘胶



Mouldline Remover  
Ébarboir  
Quitarrebabas  
Gussgratentferner  
Attrezzo per ripulire  
モールドライン・リムーバー  
合模线刮刀



Super Fine Detail Cutters  
Pince Coupante de Précision  
Tenazas de detalle superfino  
Präzisions-Seitenschneider  
Tronchesine di ultraprecisione  
スーパー・ファインディテール・カッター  
精密剪鉗

EXPLANATION OF SYMBOLS | EXPLICATION DES SYMBOLES  
EXPLICACIÓN DE SÍMBOLOS | ERLÄUTERUNG DER SYMBOLE  
LEGENDA DEI SIMBOLI | アイコン解説 | 符号説明

- Choice of parts  
• Choix d'éléments  
• Piezas opcionales  
• Auswahl an Teilen  
• Scelta di componenti  
• パーツの選択  
• 选择部件
- Repeat process  
• Répéter l'étape  
• Repetir pasos  
• Vorgang wiederholen  
• Ripeti il processo  
• 同じ作業を繰り返すこと  
• 重复步骤
- Build the number required, up to the limit shown  
• Assembler le nombre requis, jusqu'à la limite indiquée  
• Monta la cantidad requerida, hasta el limite mostrado  
• Bau die benötigte Anzahl, bis zum angegebenen Limit  
• Assembla il numero richiesto, fino al limite indicato  
• 示されている上限を超えないように、必要数を組み立てること  
• 按要数量组装直至上限
- Detail view  
• Vue détaillée  
• Vista detallada  
• Alternative Ansicht  
• Visuale del dettaglio  
• 拡大  
• 局部放大视图
- Stage complete  
• Étape terminée  
• Paso completado  
• Schritt abgeschlossen  
• Fase completa  
• このステージの完成  
• 完成
- Do not glue the components  
• Ne pas coller les éléments  
• No pegar los componentes  
• Bitte die Teile nicht kleben  
• Non incollare i componenti  
• このパーツは接着不可  
• 请勿粘接

LEGIONES ASTARTES INFANTRY  
99382601003

COMMAND SQUAD

**1**

TACTICAL LEGIONARIES

ASSAULT MARINES

PLASMA TACTICAL SUPPORT LEGIONARIES

LEGION TERMINATORS

MISSILE LAUNCHER HEAVY SUPPORT LEGIONARIES

2A



2B



2c

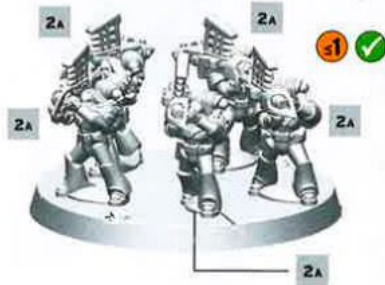

CONTEMPTOR DREADNOUGHTS

3A



3B



4A



4B

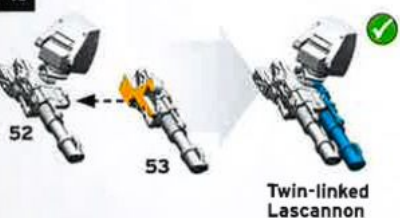

4c



3c

43. Kheres Assault Cannon

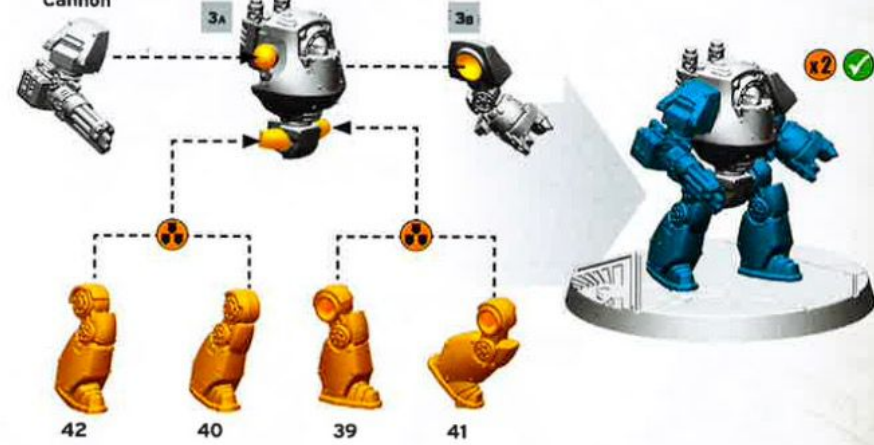

4d



Twin-linked Lascannon

# LEGIONES ASTARTES SUPPORT

99392601010

## LEVIATHAN DREADNOUGHT WITH CYCLONIC MELTA LANCE

<b>5A</b> 	<b>5B</b> 	<b>6A</b> 	<b>6B</b> 
<b>7A</b> 	<b>7B</b> 	<b>7c</b> 	<b>7d</b> 
<b>8A</b> 	<b>8B</b> 	<b>8c</b> 	<b>8A</b> Leviathan Siege Claw 

## LEVIATHAN DREADNOUGHT WITH LEVIATHAN STORM CANNON

<b>9A</b> 	<b>9B</b> 	<b>10A</b> 	<b>10B</b> 
<b>11A</b> 	<b>11b</b> 	<b>11c</b> 	<b>11d</b> 
<b>12A</b> 	<b>12b</b> 	<b>12c</b> 	<b>12a</b> Leviathan Storm Cannon 

DEREDEO DREADNOUGHT WITH ANVILUS AUTOCANNON BATTERY

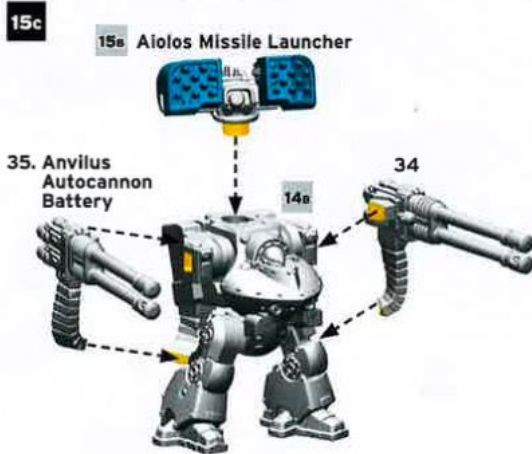

DEREDEO DREADNOUGHT WITH HELLFIRE PLASMA CANNONADE

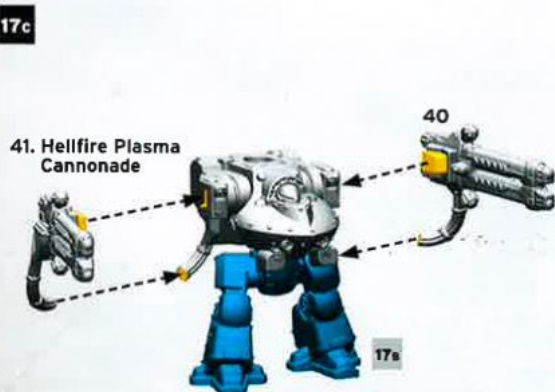
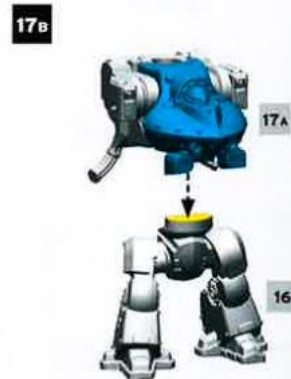
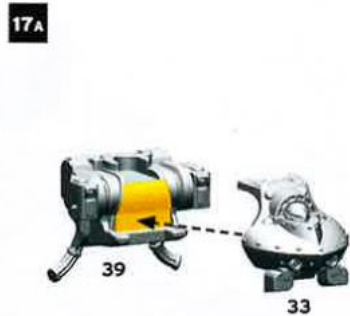
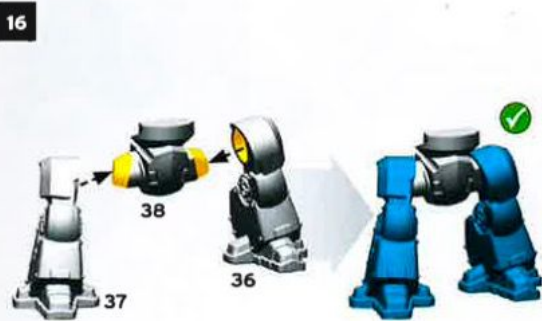

LEGION RAPIER

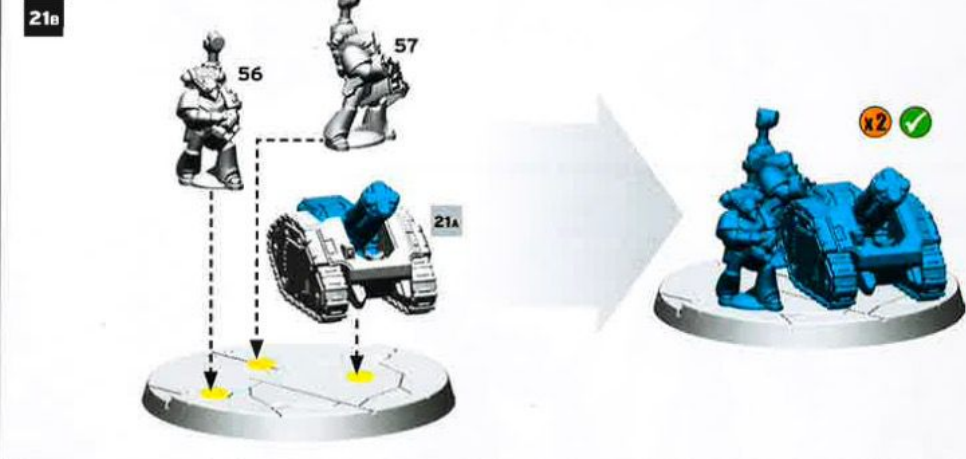

LEGION TARANTULA

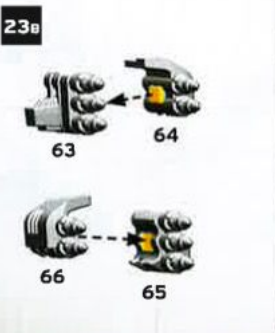
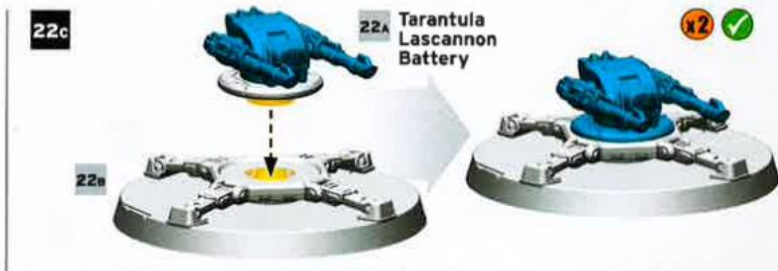
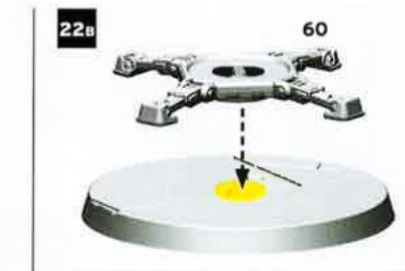

**RHINO**  
99392601008

24A

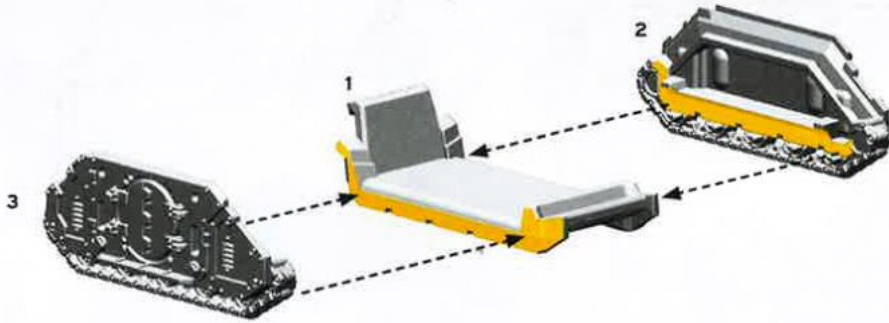

24B

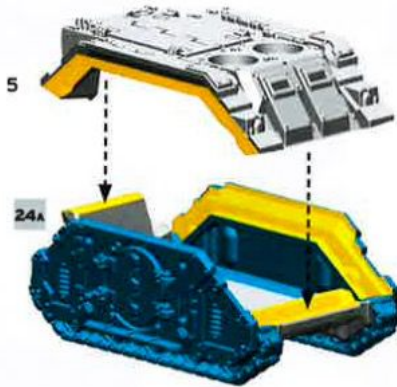

24c

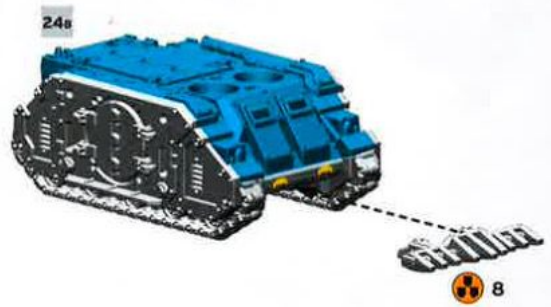

24d

24E



Pintle Mounted Multi-melta

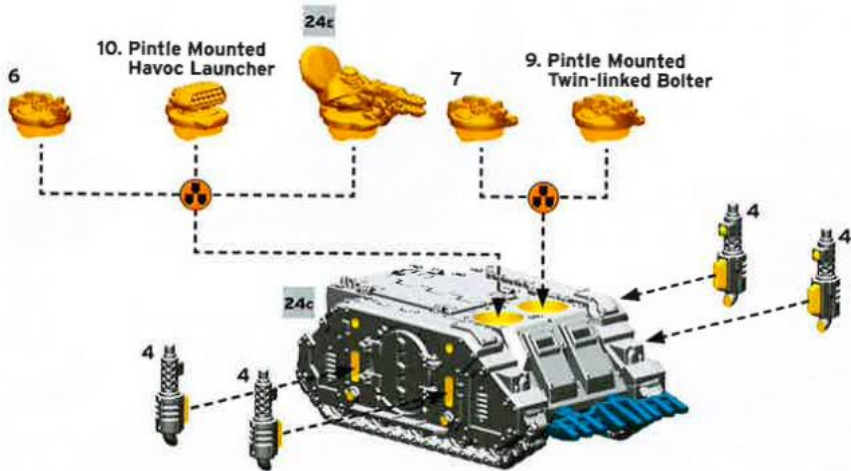

24r

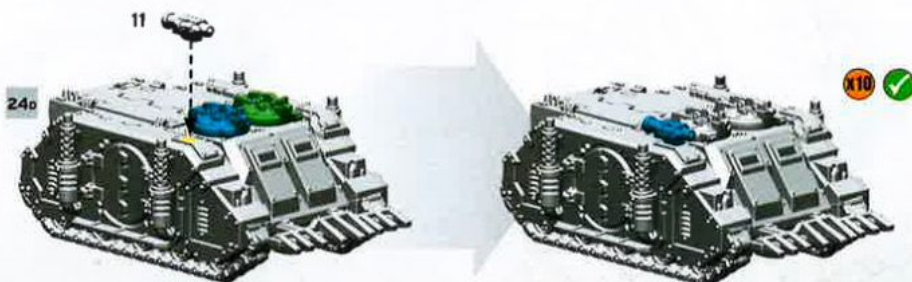



**LEGION FAST ATTACK**  
99392601014

JAVELIN

25A



25B

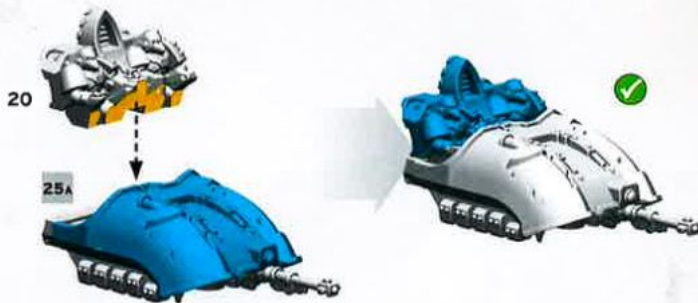

26A

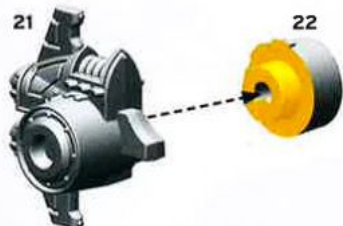

26B



26c



27. Cyclone Missile Launcher

Sponson Mounted Lascannon

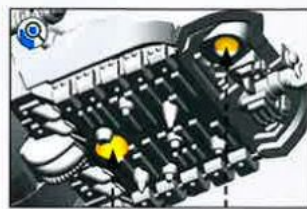

**SCIMITAR JETBIKE**

27

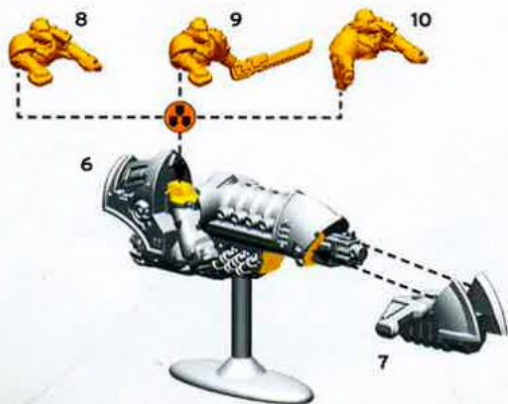

OUTRIDER

28

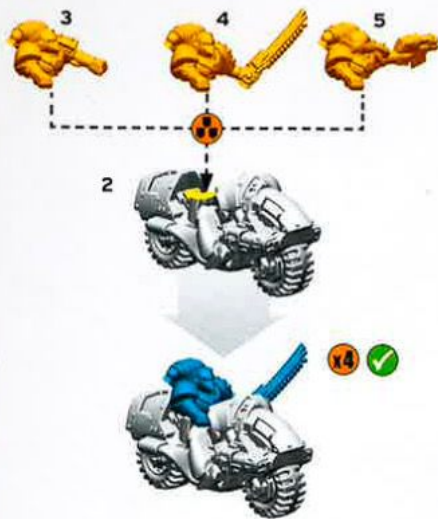

29

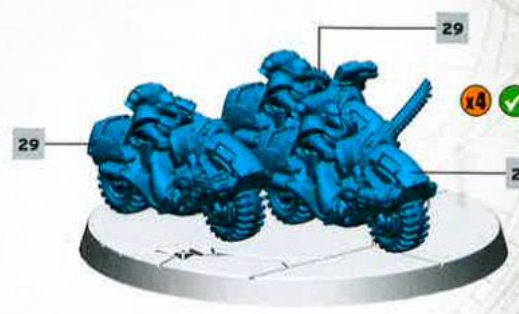
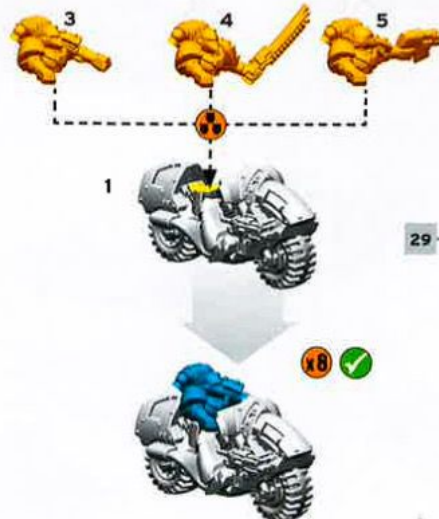

LAND SPEEDER

30

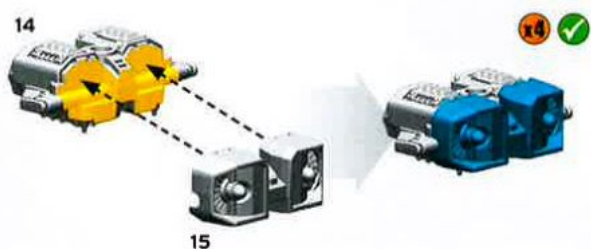

31A

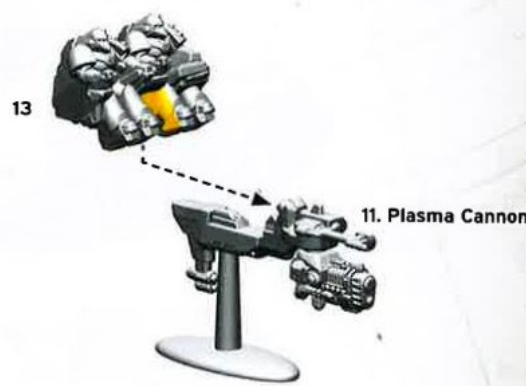

31B

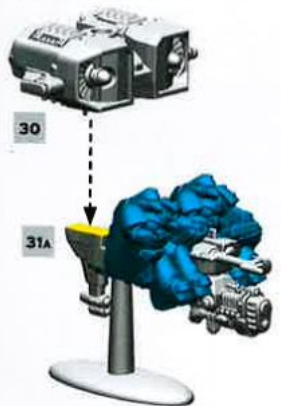

31C



32A

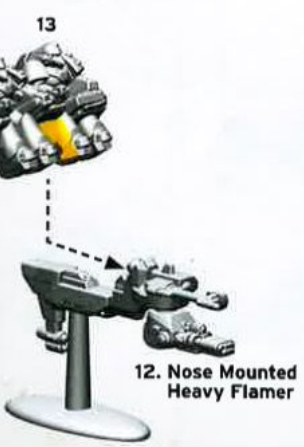

32B



32C



**LEGION KRATOS**  
99392601002

33A

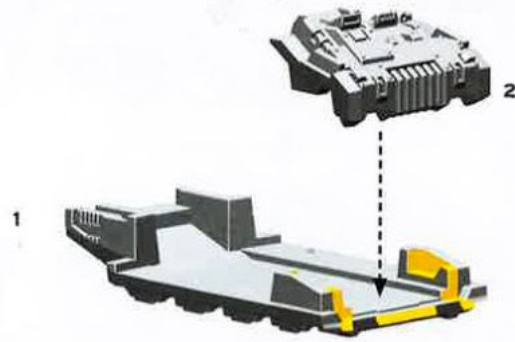

33B

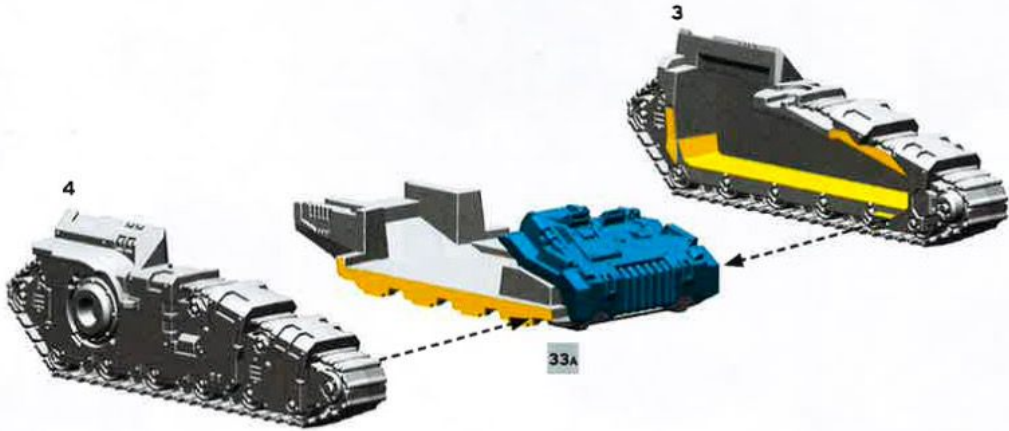

33C

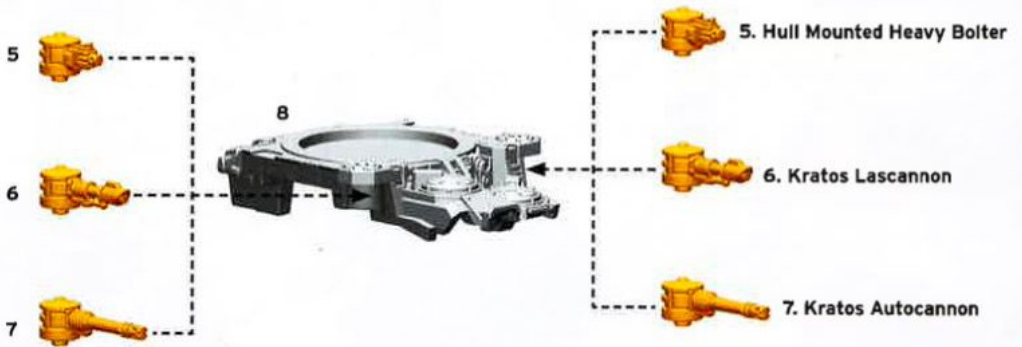

33D

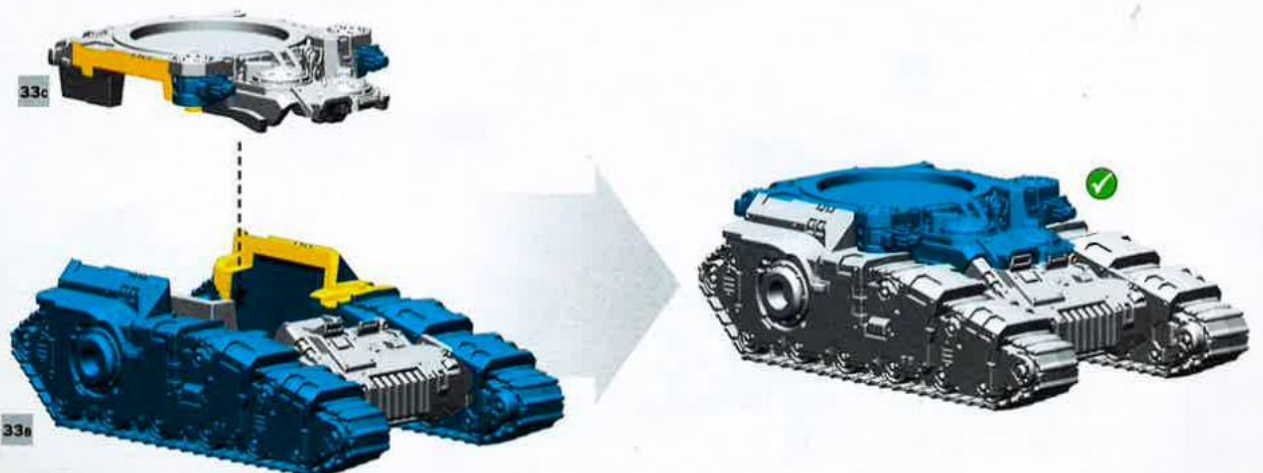

34

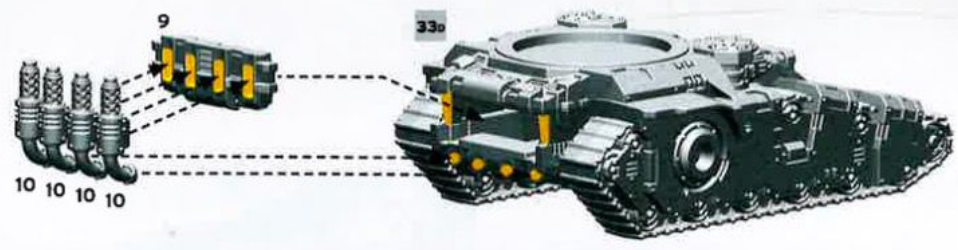

35



36A



Kratos Battlecannon



Melta Blastgun

36B

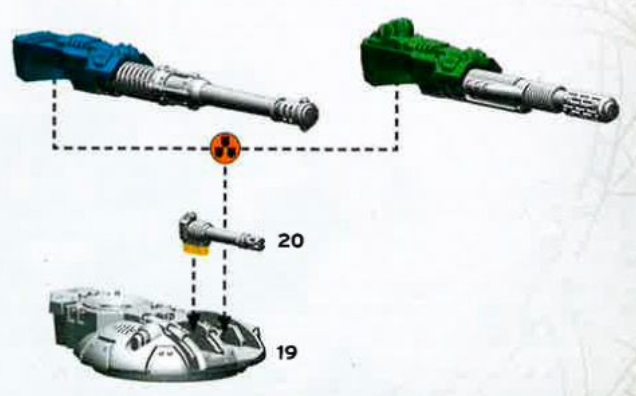
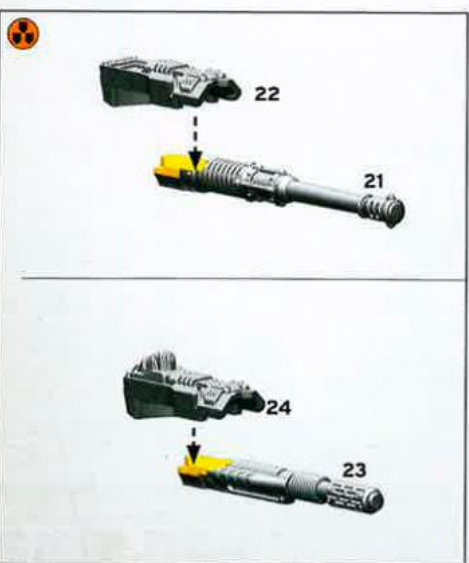

36c

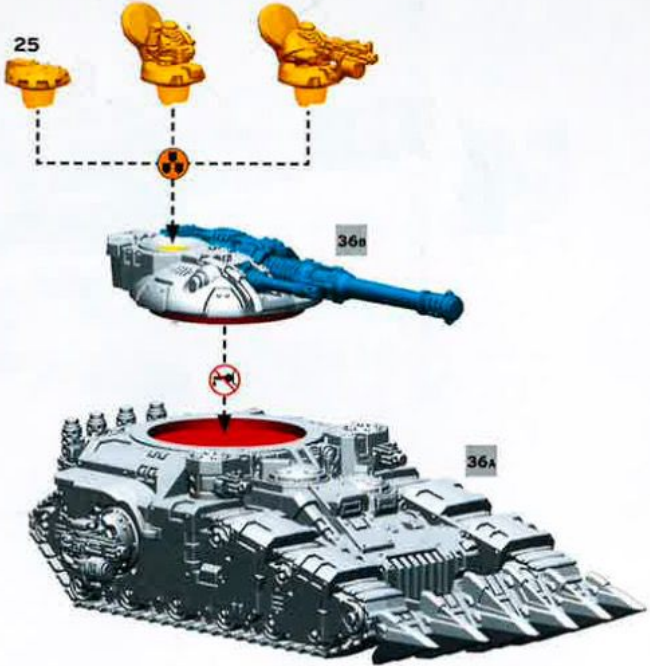
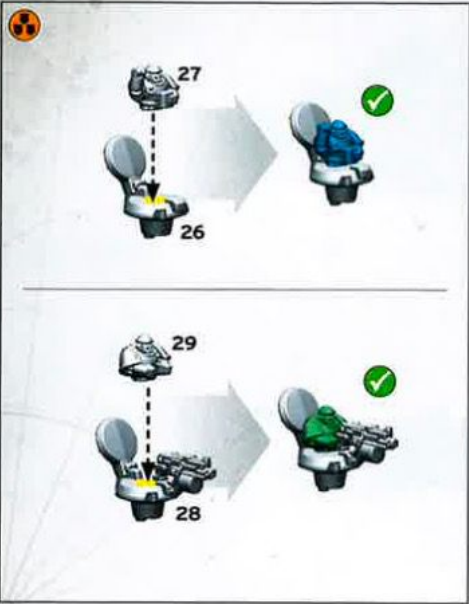

36d

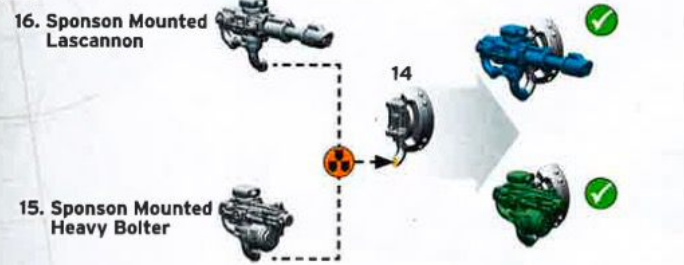

36e

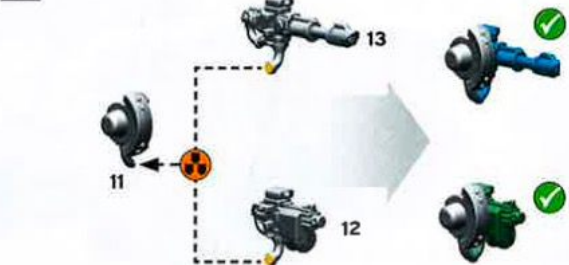

36f

