



Free Downloads of Build Instructions,
Assembly Booklets & How To Guides

BuildInstructions.com

IMPERIAL™ ARMOUR

SPACE MARINE FELLBLADE

Product code 99590101283

The copyright on the model designs and components within this box is the exclusive property of Games Workshop Ltd. Copyright Games Workshop Ltd., 2012. All rights reserved.

COMPONENTS LIST	
1. Gun mount x2	34. Track section R1
2. Sponson plate x2	35. Track section L1
3. Sponson pin x2	36. Track section L5
4. Exhaust pipe x2	37. Track section R5
5. Exhaust x4	38. Track section L6
6. Left hand hull	39. Track section R6
7. Right hand hull	40. Front plate
8. Hull bracket 1 x2	41. Gun plate
9. Hull bracket 2 x2	42. Demolisher cannon
10. Hull bracket 3 x2	43. Door x2
11. Front wheel bracket LHS	44. Track guard LHS
12. Front wheel bracket RHS	45. Track guard RHS
13. Engine	46. Barrels x2
14. Hull front	47. Heavy bolters
15. Driver	48. Hatches x2
16. Commander	49. Conduit RHS
17. Commander arm x2	50. Conduit LHS
18. Stowage	51. Bolter cover
19. Gun turret	52. Gun shield LHS
20. Hull top	53. Gun shield RHS
21. Double accelerator cannon	54. Targeting array x2
22. Lascannon 1 LHS	55. Primary power coupling x2
23. Lascannon 1 RHS	56. Tertiary power coupling x2
24. Lascannon 2 LHS	57. Secondary power coupling x2
25. Lascannon 2 RHS	58. Commander's shoulder pads
26. Rear wheel R7	
27. Front wheel R3	
28. Front wheel L3	
29. Rear wheel L7	
30. Track section R2	
31. Track section L2	
32. Track section R4	
33. Track section L4	

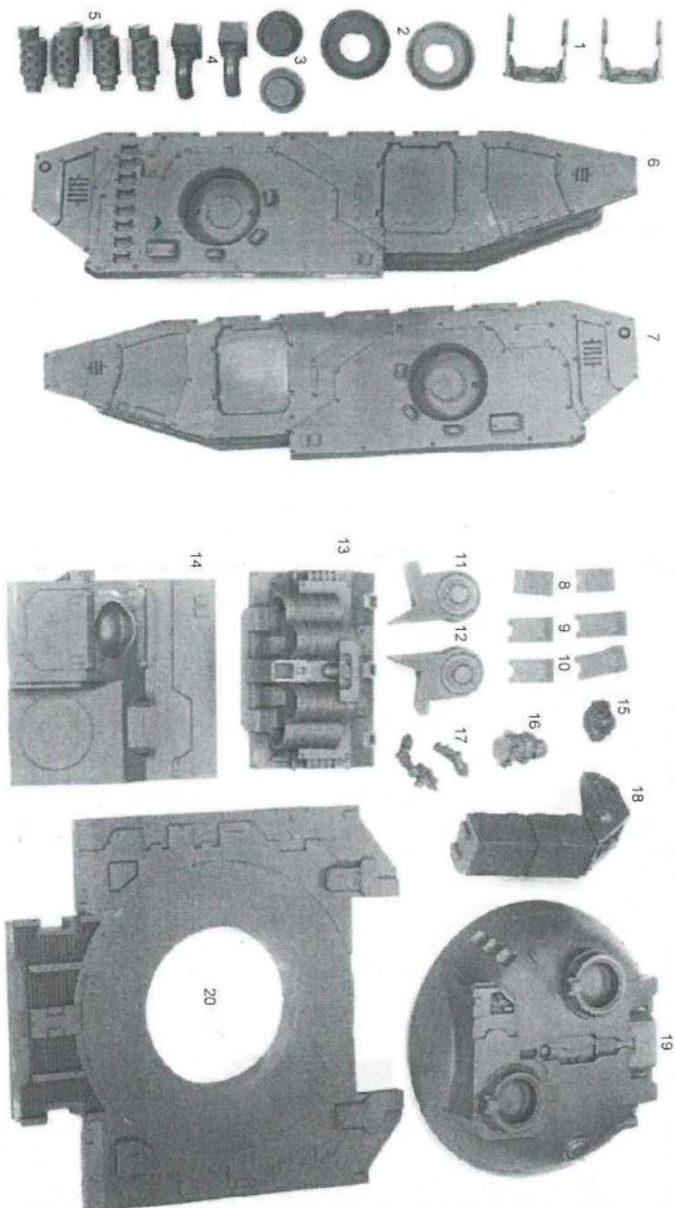

This kit contains all the pieces required to construct a Space Marine Fellblade. To glue the resin pieces together use Citadel Super Glue.

NOTE: We have cast this kit using the most advanced techniques and the best quality resin, but due to the nature of the casting process your model may contain very slight air bubbles. These can easily be filled with model filler or super glue. Any slight warpage of thin parts can easily be corrected by immersing the part in hot tap water for about 1 minute then carefully bending it back into shape.

THIS IS NOT A TOY

Not suitable for children under 15 years of age.

WARNING: Resin dust can be harmful if inhaled. Always wear a dust mask or respirator when sanding or sawing resin parts.

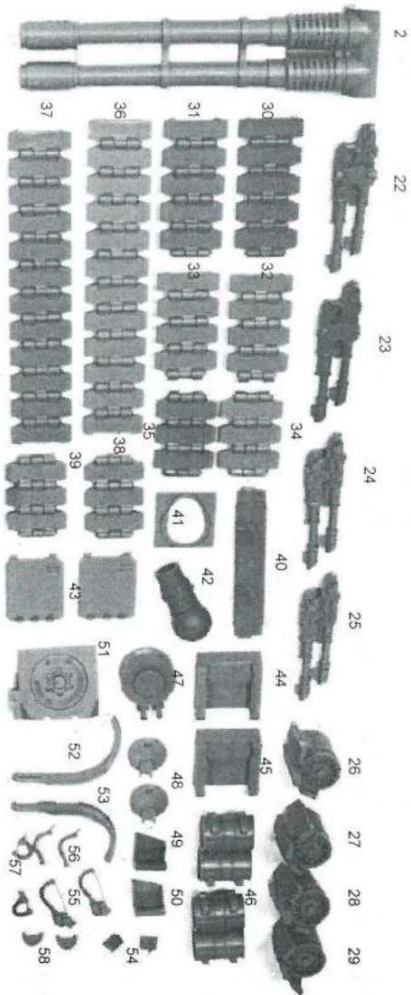

IMPERIAL ARMOUR™

The copyright on the model designs and components within this box is the exclusive property of Games Workshop Ltd. Copyright Games Workshop Ltd., 2012. All rights reserved.

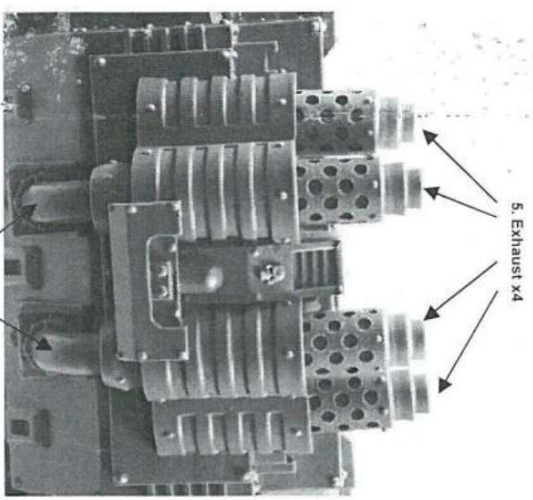

5. Exhaust x4

4. Exhaust pipe x2

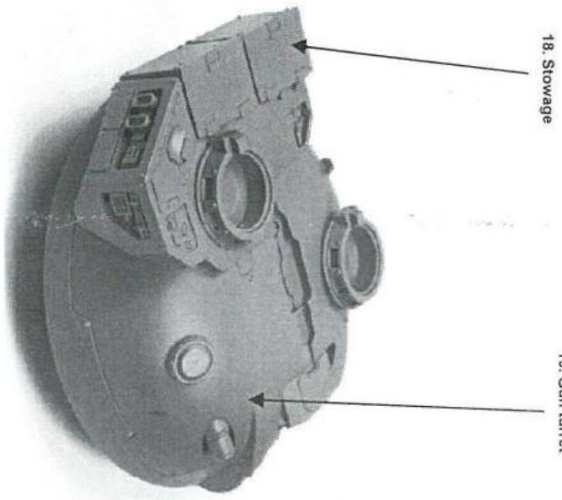

18. Stowage

19. Gun turret

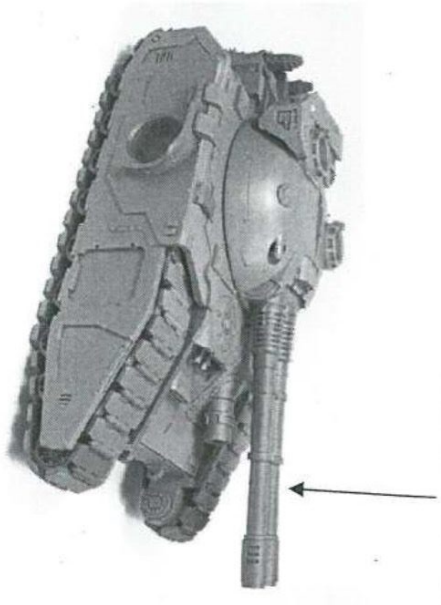

21. Double accelerator cannon

Assemble lascannons for each side as shown

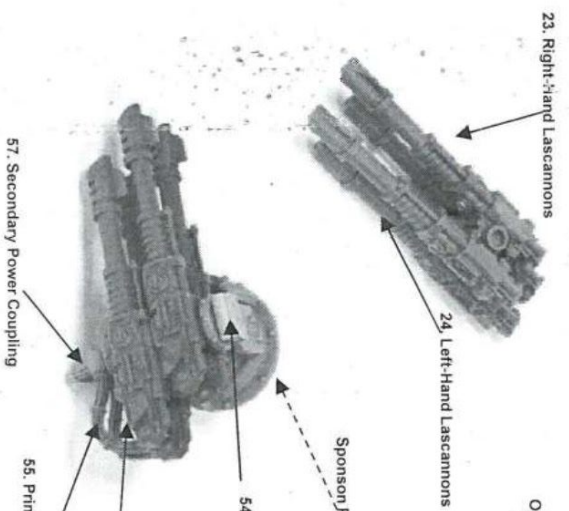

23. Right-Hand Lascannons

24. Left-Hand Lascannons

57. Secondary Power Coupling

55. Primary power coupling

ONLY PLACE A SMALL AMOUNT OF GLUE IN THE CENTER BY THE ARROW HEAD

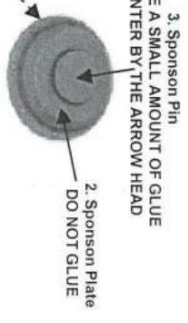

3. Sponson Pin

2. Sponson Plate DO NOT GLUE

Sponson Plate Assembly

1. Gun mount

54. Targeting array

56. Tertiary Power Coupling



Parts 16. Commander, 17. Arms & 58. Shoulder pads

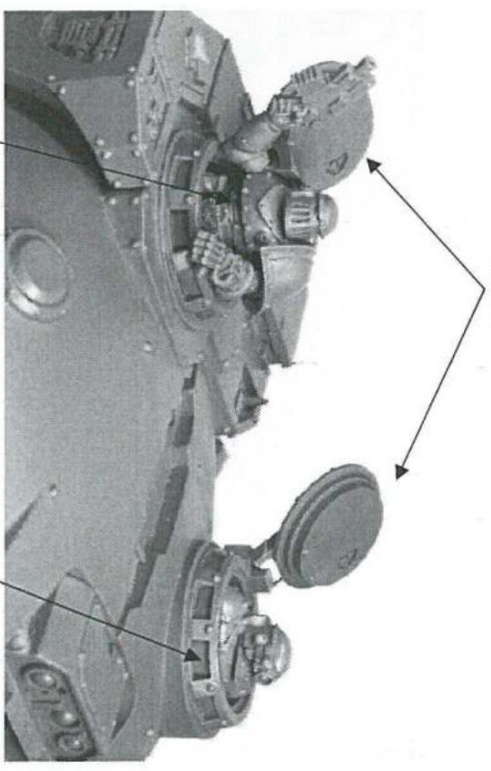

48. Hatches

15. Driver

EMPERIAL- ARMOUR

Assemble plastic components as shown

NB: Assemble parts 14, 40, 20 and 13 loose before gluing to get the best fit

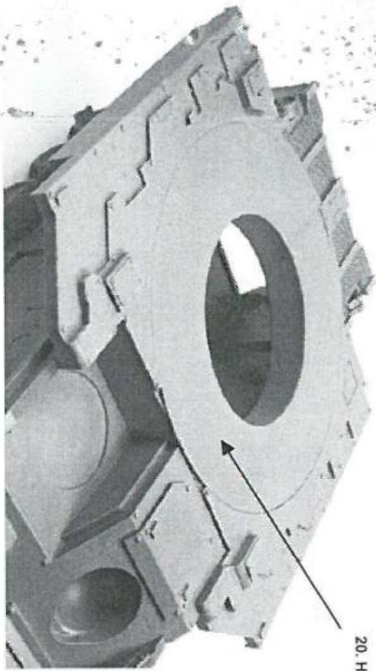
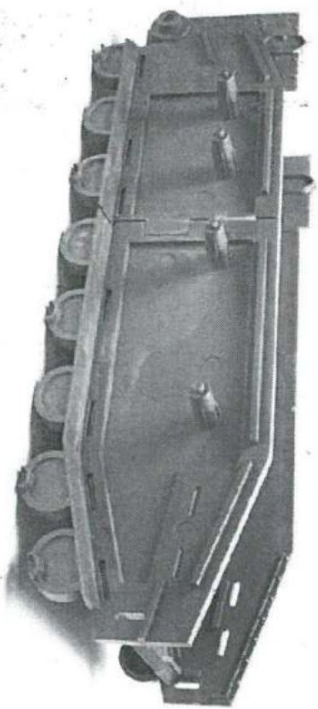

20. Hull top

Attach track sections L1, L2, R1 and R2 to the left and right hull sections

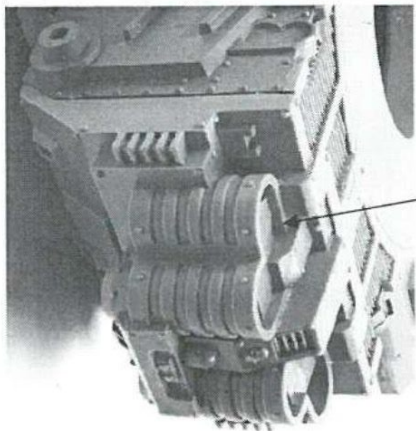
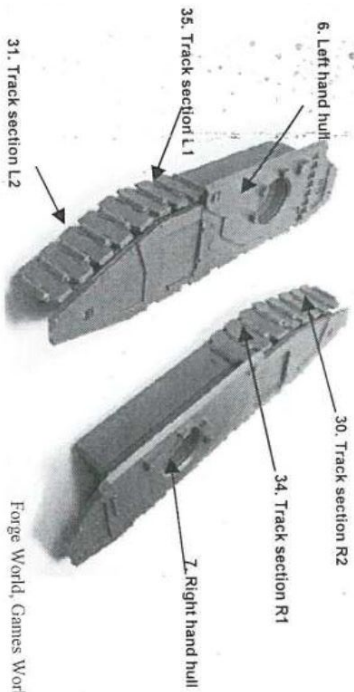

13. Engine

Attach hull sections 6/7

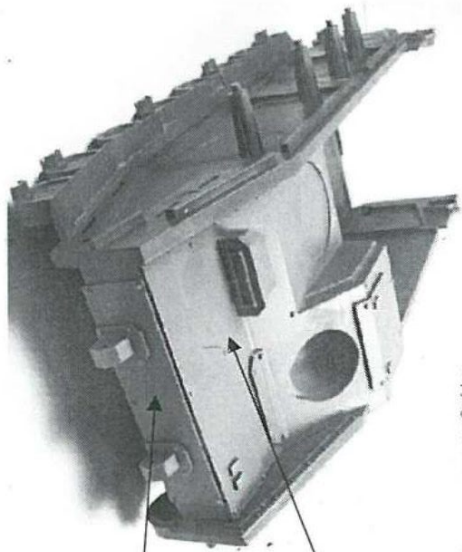
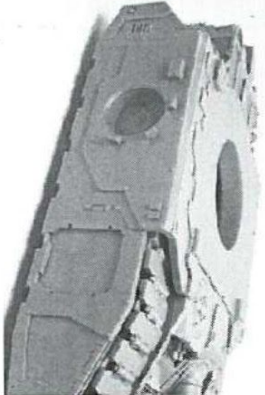

14. Hull front

40. Front plate

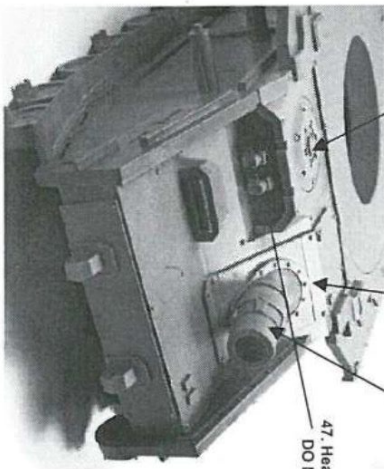

51. Boiler cover

41. Gun plate
42. Demolisher cannon - DO NOT GLUE

47. Heavy bolters - DO NOT GLUE

52 & 53 Gun shields

Attach both sides as shown

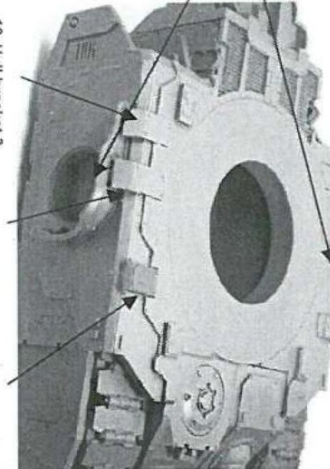

10. Hull bracket 3

9. Hull bracket 2

8. Hull bracket 1

The copyright on the model designs and components within this box is the exclusive property of Games Workshop Ltd. Copyright Games Workshop Ltd., 2012. All rights reserved.

IMPERIAL ARMOUR™

Remove plastic lugs from plastic wheel sections with clippers



Attach plastic wheel sections to resin hull

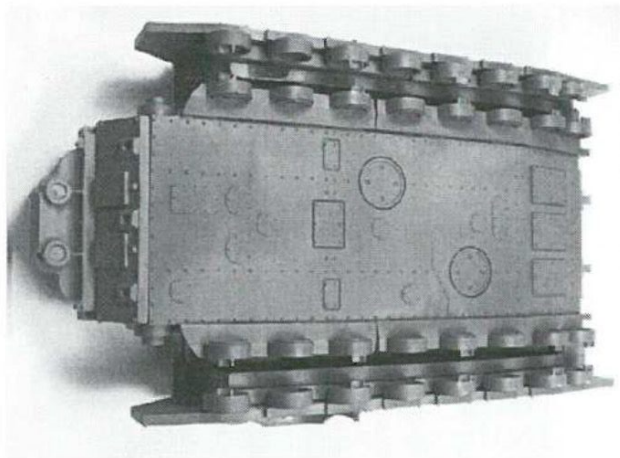

Attach front wheel brackets 11 & 12 as shown

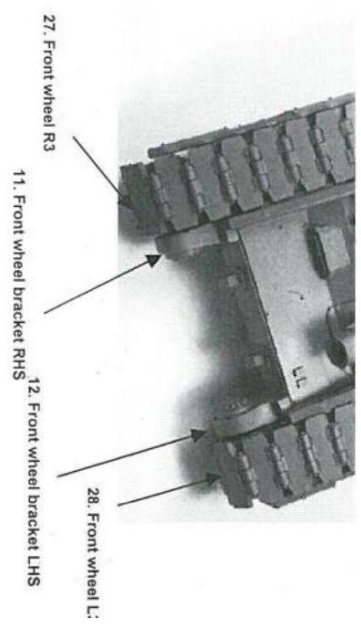

37. Track section R5

33. Track section R4

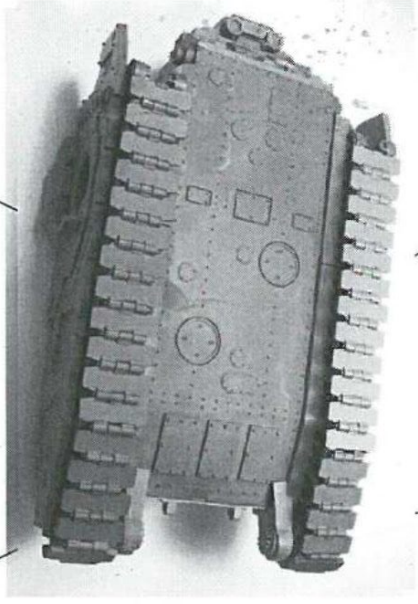

36. Track section L5

33. Track section L4

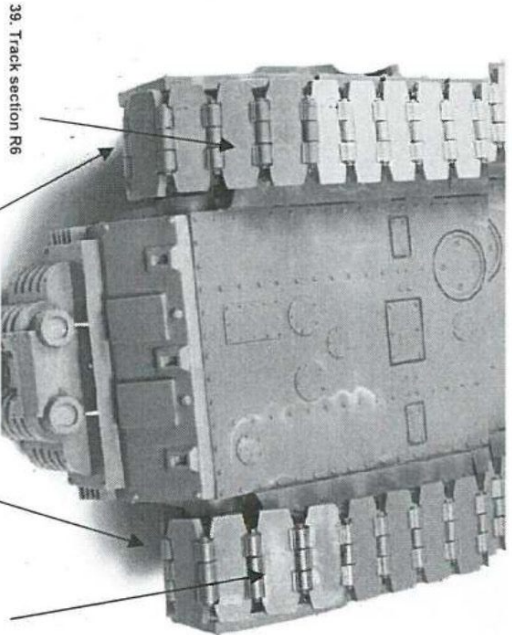

39. Track section R6

26. Rear wheel R7

29. Rear wheel L7

38. Track section L6

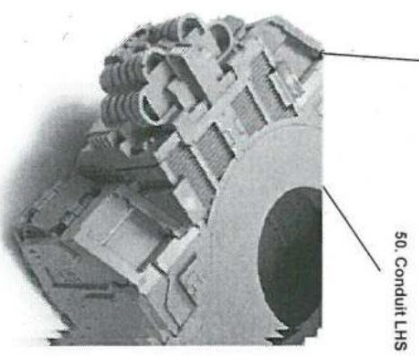

44. Track guard LHS

50. Conduit LHS

49. Conduit RHS

45. Track guard RHS

The copyright on the model designs and components within this box is the exclusive property of Games Workshop Ltd. Copyright Games Workshop Ltd., 2012. All rights reserved.

Forge World, Games Workshop, Willow Road, Lenton, Nottingham, NG7 2WS, UK. Tel. 0044 (0)115 916 8177

IMPERIAL ARMOUR™

46. Barrels

Assemble both sides as shown

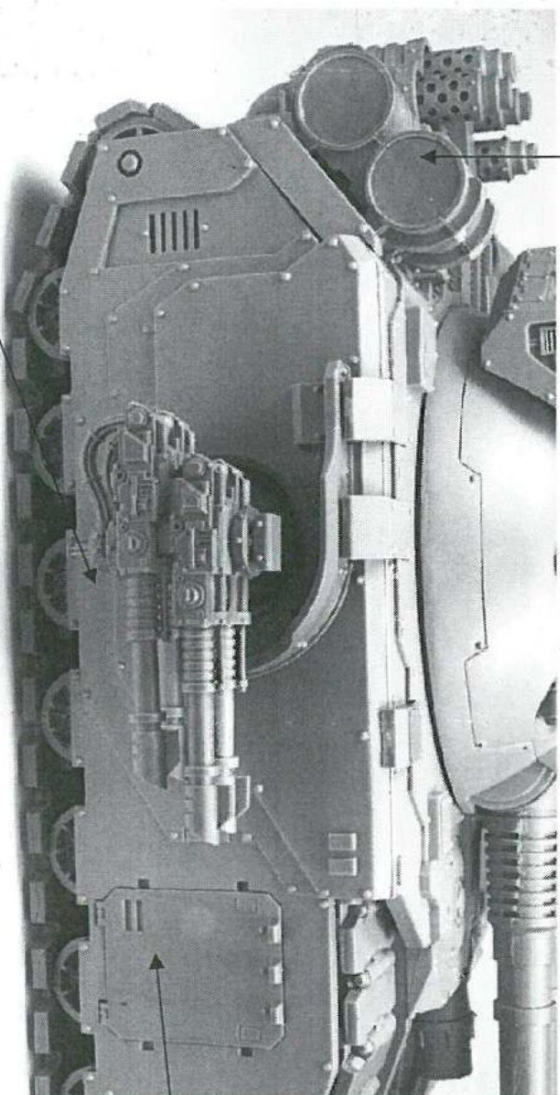

43. Door

Attach lascannons as shown

