



Free Downloads of Build Instructions,
Assembly Booklets & How To Guides

BuildInstructions.com

WARHAMMER 40,000



LEAGUES OF VOTANN ARMY SET



READ THIS FIRST | À LIRE EN PRIORITÉ | BITTE BEACHTE | LEE ESTO PRIMERO | LEGGI PRIMA QUESTO | В ПЕРВУЮ ОЧЕРЕДЬ ПРОЧИТАЙТЕ ЭТО
最初にお読みください。 | 请优先阅读

ENG BEFORE ASSEMBLING YOUR MINIATURES, PLEASE READ THROUGH THE INSTRUCTIONS IN THIS BOOKLET CAREFULLY. A pair of plastic cutters is required to remove the plastic components in this kit from their frame. We advise using a mouldline scraping tool to clean up the parts. To assemble your model you will need plastic glue. Games Workshop sells Citadel Fine Detail Cutters, Citadel Mouldline Remover and Citadel Plastic Glue, but does not recommend these products for use by children under the age of 16 without adult supervision.

FRE AVANT D'ASSEMBLER VOS FIGURINES, VEUILLEZ LIRE ATTENTIVEMENT LES INSTRUCTIONS DE CE LIVRET. Une pince coupante est requise pour détacher chaque élément de sa grappe. Nous vous recommandons l'utilisation d'un grattoir pour ébarber les éléments. Pour l'assemblage, vous aurez également besoin de colle plastique. Games Workshop commercialise les Pinces de Précision Citadel, l'Ebarboir Citadel et la Colle Plastique Citadel, mais n'en recommande pas l'utilisation pour des enfants de moins de 16 ans sans la supervision d'un adulte.

SPA POR FAVOR, LEE CUIDADOSAMENTE ESTE LIBRETO DE INSTRUCCIONES ANTES DE EMPEZAR A MONTAR LAS MINIATURAS. Te harán falta unas tenazas para plástico a fin de separar las piezas de la matriz. También aconsejamos una herramienta para rebabas a fin de limpiar cada pieza. Para montar la miniatura necesitarás pegamento para plástico. Games Workshop vende Tenazas Citadel, Herramientas para rebabas Citadel y Pegamento para plástico Citadel, pero no recomienda estos productos a menores de 16 años sin la supervisión de un adulto.

GER VOR DEM ZUSAMMENBAU DER MINIATUREN BITTE DIE ANWEISUNGEN IN DIESER ANLEITUNG AUFMERKSAM DURCHLESEN. Du benötigst einen Kunststoffseitschneider, um die Kunststoffbauteile aus dem Gussrahmen herauszutrennen, und Kunststoffkleber, um die Miniatur zusammenzubauen. Außerdem empfehlen wir, die Bauteile vorher mit einem Gussgratentferner zu säubern. Games Workshop bietet Präzisions-Kunststoffseitschneider von Citadel sowie Citadel-Kunststoffkleber an, empfiehlt aber, dass Kinder unter 16 Jahren diese nur unter Aufsicht eines Erwachsenen benutzen.

ITA PRIMA DI ASSEMBLARE LE TUE MINIATURE LEGGI ATTENTAMENTE TUTTE LE ISTRUZIONI DI QUESTO LIBRETTO. Sono necessarie un paio di tronchesine per plastica per staccare i componenti dai loro sprue. Consigliamo di usare un attrezzo apposito per pulire i componenti. Per assemblare il modello avrai bisogno di colla per plastica. Games Workshop vende Tronchesine di precisione Citadel, Attrezzo per ripulire Citadel e Colla per plastica Citadel, ma non consiglia questi prodotti ad un pubblico minore di 16 anni senza la supervisione di un adulto.

RUS Кусачки для пластика нужны для снятия пластиковых элементов набора с рамок. Для зачистки деталей рекомендуем использовать инструмент для удаления дефектов. Для сборки модели вам понадобится клей для пластика. Компания "Games Workshop" предоставляет кусачки "Citadel Fine Detail Cutters", инструмент для удаления дефектов "Citadel Mouldline Remover" и клей для пластика "Citadel Plastic Glue", но не рекомендует эти изделия к использованию детьми младше 16 лет без надзора взрослых.

日本語 本キット内のフレームからプラスチックパーツを切り離すためには、ニッパーが必要です。パーツのモールドを平らにするには、専用ツールの使用をお勧めいたします。本キットの組み立てには、プラ用接着剤が必要です。ゲームズワークショップはシタデル・ニッパー、プラ用接着剤、シタデル・モールドラインリムーバーを販売しておりますが、16歳以下の子供が大人の監督なしにこれらの道具を使用されることをお勧めしません。

中文 你需要一把模型剪将塑料部件从板件上剪下来。我们建议使用分模线刮刀来处理零件。组装时你还需要用到模型胶水。你可以从 Games Workshop 处购买到 Citadel Fine Detail Cutter 模型剪、Citadel Mouldline Remover 分模线刮刀和 Citadel Plastic Glue 模型胶，但 16 岁以下儿童不得在没有成年人监护的情况下使用这些产品。

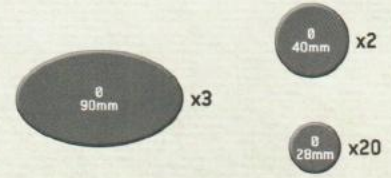
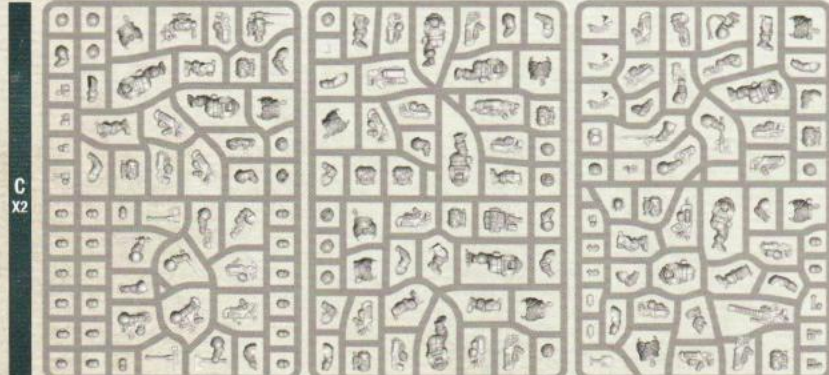

BUILD VARIANTS | VARIANTES D'ASSEMBLAGE | VARIANTES DE MONTAJE | BAUVARIANTEN | VARIANTI D'ASSEMBLAGGIO | ВАРИАНТЫ СБОРКИ
 バリエーション | 变体版

- Assemblies for build variants are colour coded.
- Les assemblages de variantes ont un code couleur.
- Las instrucciones para montajes alternativos se indican con un color diferente.
- Optionen für Bauvarianten sind farblich markiert.
- Le diverse varianti d'assemblaggio sono divise per colore.
- Различные варианты сборки выделены разными цветами.
- バリエーション違いの組み立ては色分けされている。
- 变体版拼装部件有颜色区分



EXPLANATION OF SYMBOLS | EXPLICATION DES SYMBOLES | EXPLICACIÓN DE SÍMBOLOS | ERLÄUTERUNG DER SYMBOLE | LEGENDA DEI SIMBOLI
 РАСШИФРОВКА СИМВОЛОВ | アイコン解説 | 符号说明

- Special instruction - Please read
 - Instructions spéciales - Lire attentivement
 - Instrucción especial: Por favor, léala
 - Besondere Anweisung - Bitte lesen
 - Istruzioni speciali - Leggi attentamente
 - Особая инструкция - просьба ознакомиться
 - 特記事項 - 必ずお読みください
 - 特殊说明 - 请详阅
- Dry fit stage before gluing
 - Tester avant de coller
 - Comprobar el encaje antes de pegar
 - Positionierung erst ohne Klebstoff ausprobieren
 - Prova a secco prima di incollare
 - Этап предварительной сборки перед склеиванием
 - 接着前にぴったり合わせること
 - 粘接前的假组阶段
- Variant assembly
 - Variante d'assemblage
 - Variante de montaje
 - Bauvariante
 - Assemblaggio alternativo
 - Varianti сборки
 - 組み立てバリエーション
 - 多种组装方式
- Choice of parts
 - Choix d'éléments
 - Modelos de componentes
 - Auswahl an Teilen
 - Scelta di componenti
 - Выбор деталей
 - パーツの選択
 - 选择部件
- Stage complete
 - Étape terminée
 - Paso completado
 - Schritt abgeschlossen
 - Fase completa
 - Этап завершен
 - このステージの完成
 - 完成
- Assembly sequence
 - Séquence d'Assemblage
 - Secuencia de montaje
 - Baureihenfolge
 - Sequenza di assemblaggio
 - Последовательность сборки
 - 組み立て手順
 - 拼装顺序
- Use matching parts
 - Utiliser les éléments correspondants
 - Usa las piezas que correspondan
 - Verwende die passenden Teile
 - Usa le parti corrispondenti
 - Последовательность сборки
 - 適合するパーツを使用
 - 使用匹配部件
- Repeat process
 - Répéter l'étape
 - Repetir pasos
 - Vorgang wiederholen
 - Ripeti il processo
 - Повторите действие
 - 同じ作業を繰り返すこと
 - 重复步骤

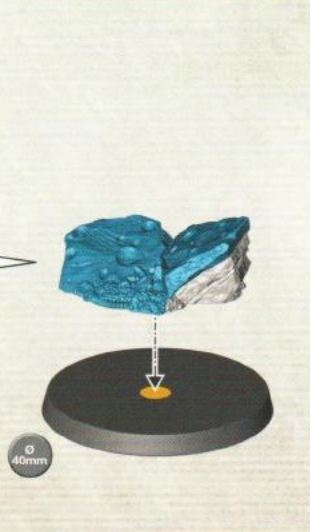
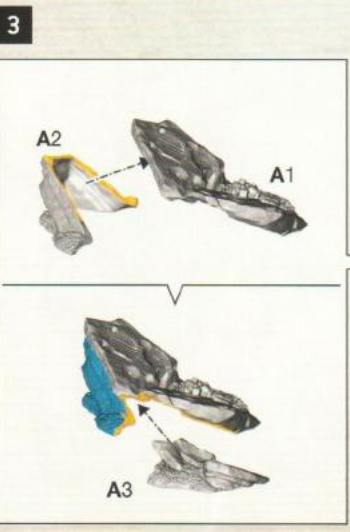
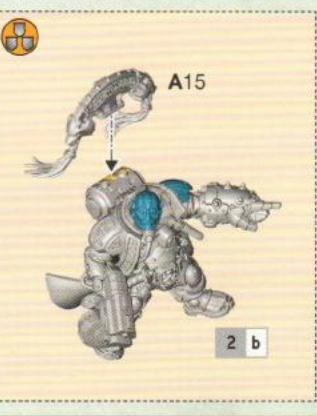
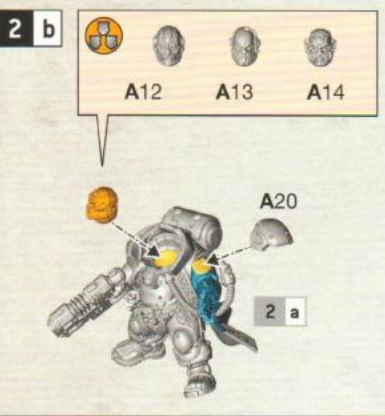
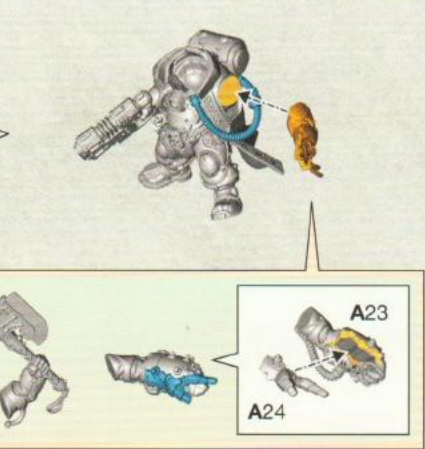
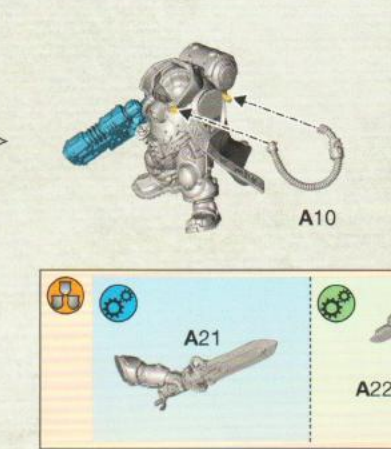
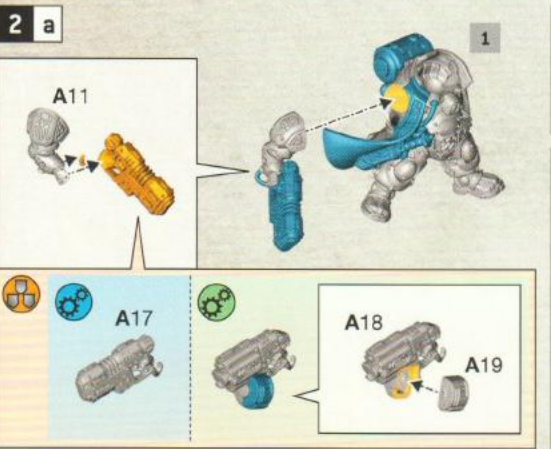
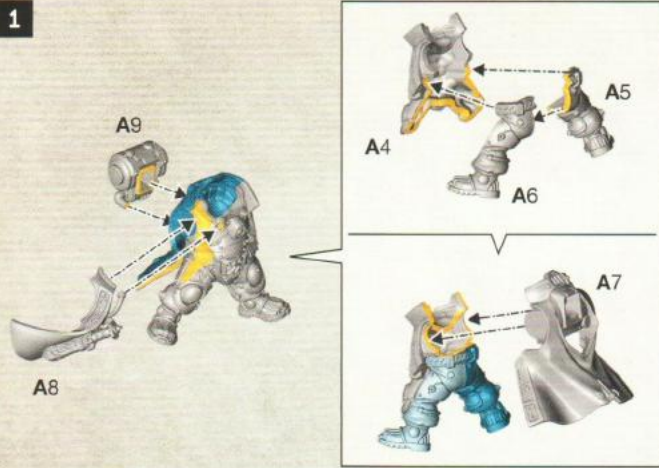

4 a

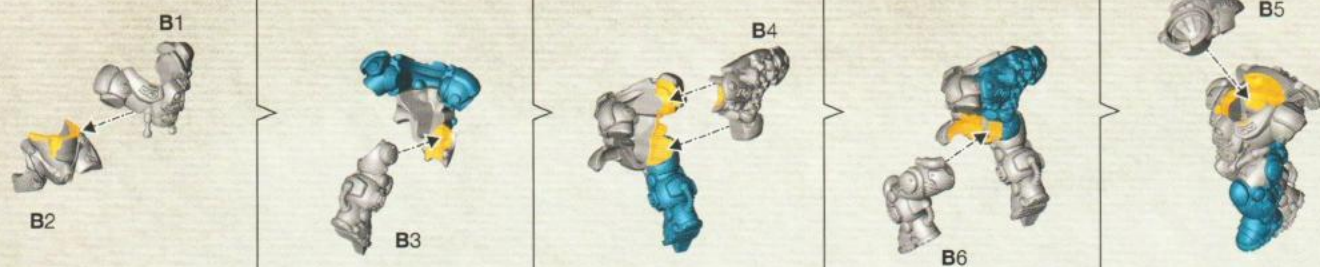

4 b

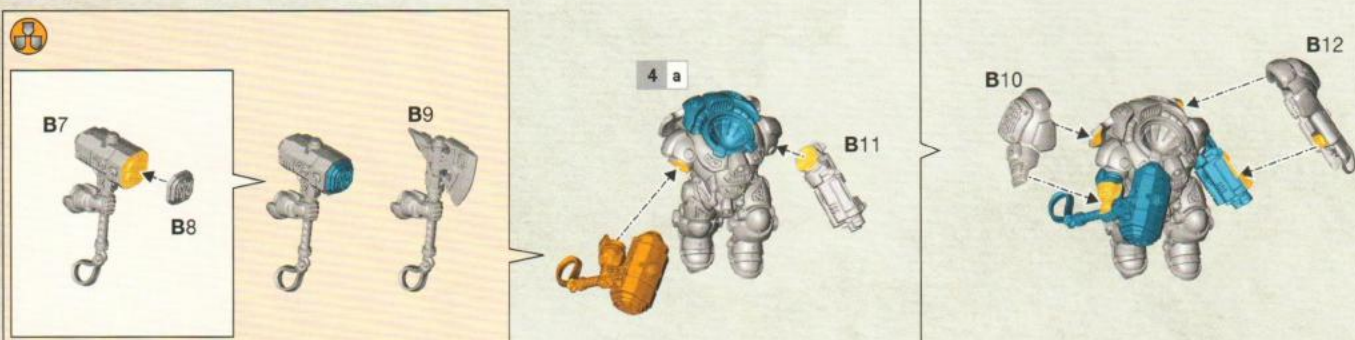

4 c

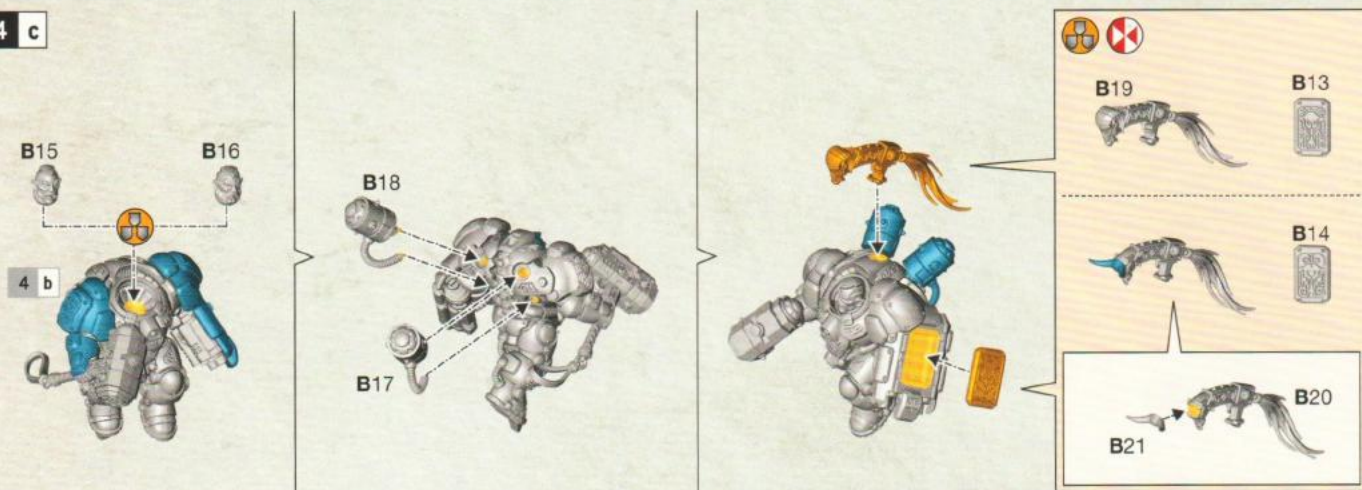

4 d



ENG More painting guides can be found on citadelcolour.com

FRE D'autres guides de peinture sont disponibles citadelcolour.com

SPA Encontrarás más guías de pintura en citadelcolour.com

GER Weitere Bemalanleitungen auf citadelcolour.com

ITA Puoi trovare altre guide alla pittura su citadelcolour.com

RUS Дополнительные инструкции по покраске на сайте citadelcolour.com

日本語 citadelcolour.comには他にも様々なペイントガイドが掲載されている

中文 更多涂装指南请至 citadelcolour.com

CITADEL
COLOUR



5

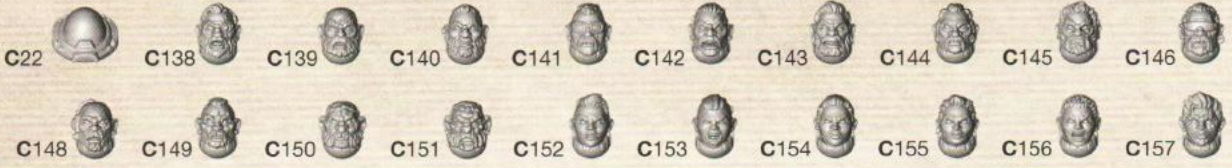

6 a



6 b



7 x2

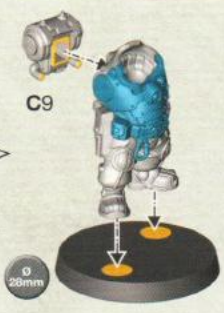
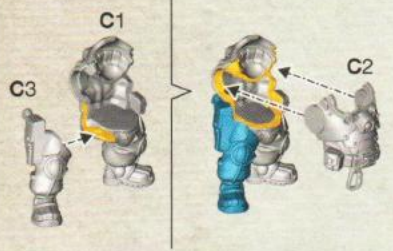

8 x1



9



• Theyn • Тхейн • Hearthkyn Warrior • Guerrier Åtrekog • Sucesor • Flammkynkrieger • Guerriero Confratello del Focolare • Воинственный Горнец • ハースキン・ウォリアー • 炉心战士

8 a

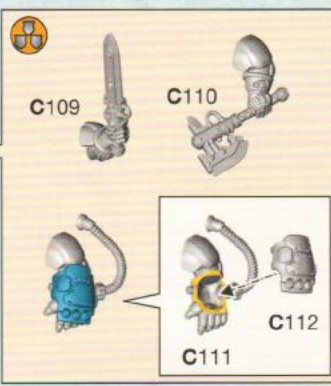
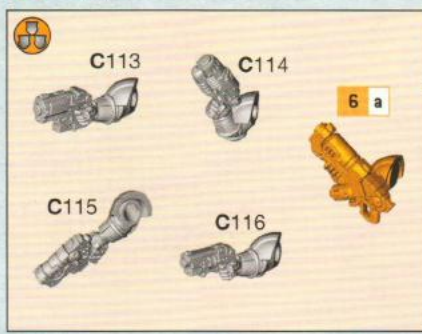

8 b

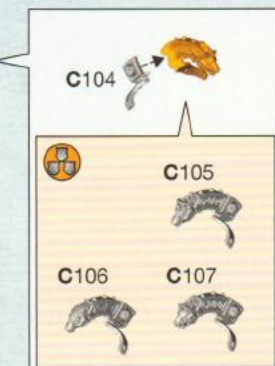

9

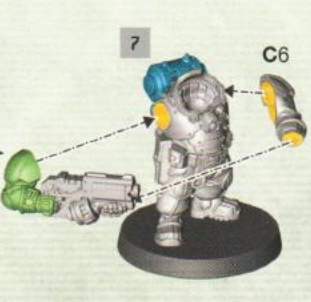
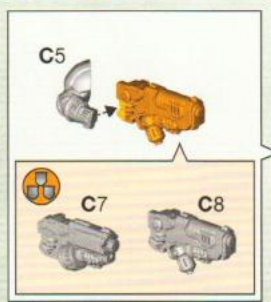

10 a x2



10 b



10 c



10 b

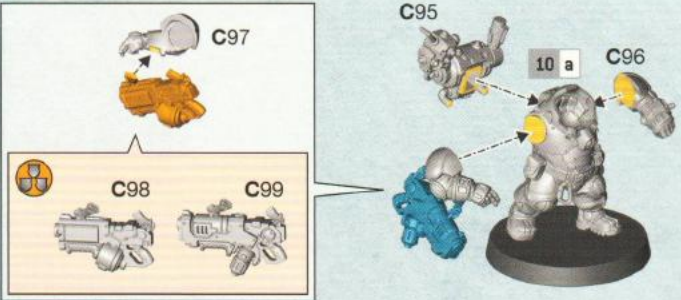

10 c

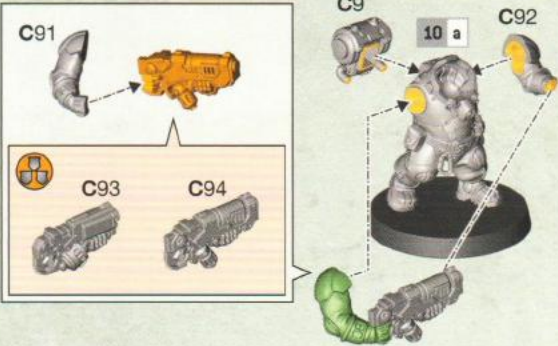

11 a x2

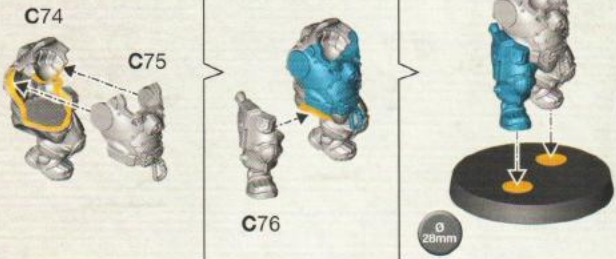

11 b



11 c



11 b

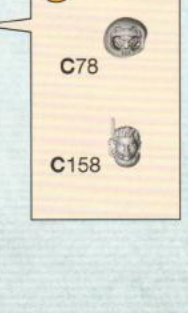
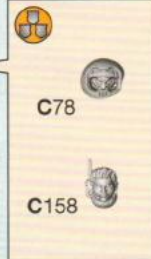
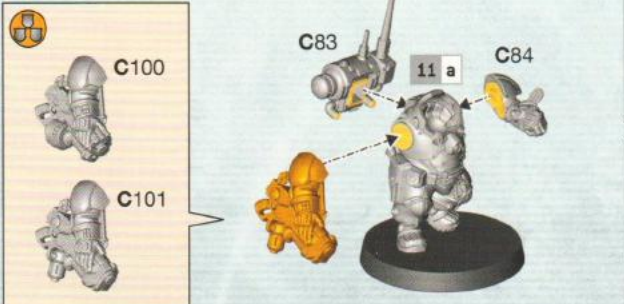

11 c

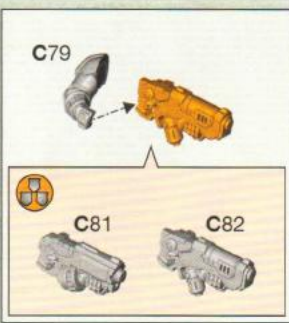

12 a x2



12 b



12 c



12 b



12 c

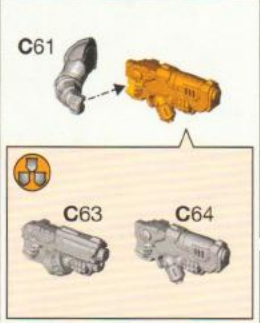

12 d x2



13 a x2



13 b



13 c



13 b

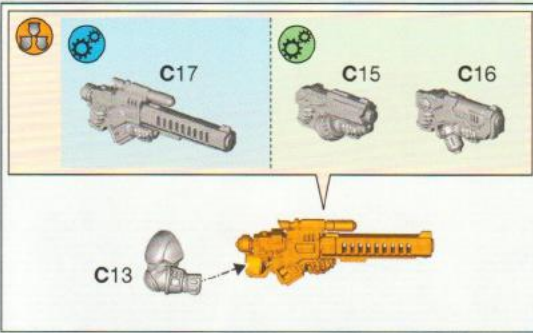

13 c



13 d x2

13 b/c

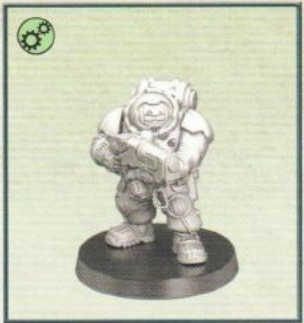
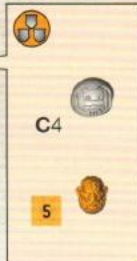

14 a x2

C18

C19

C20

C21

C9



ø 28mm

14 b



14 c



14 b

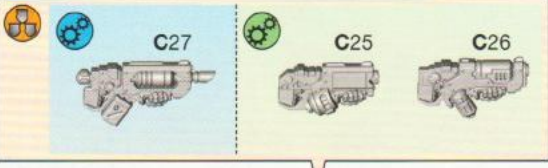

C23



14 a

C24



14 c

14 a

6 b

6 a



14 d x2

14 b/c

5



15 a x2

C28

C29



C30

C9



ø 28mm

15 b



15 c



15 b

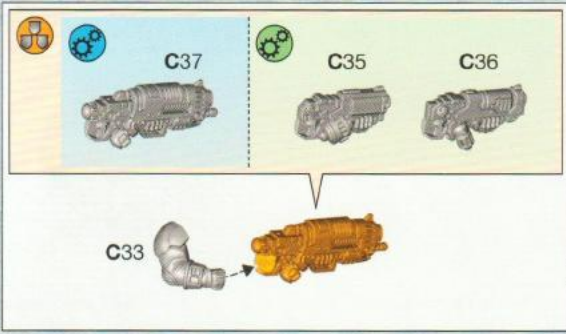

15 c



15 d x2



16 a x2

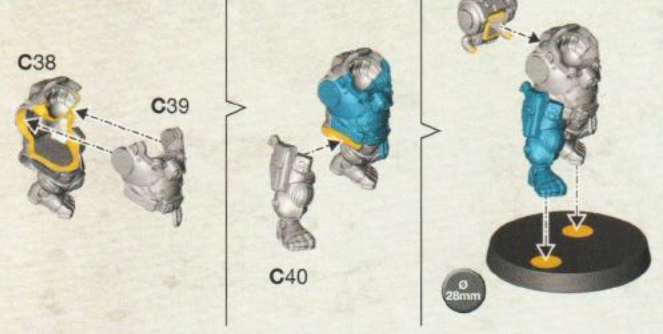

16 b



16 c



16 b

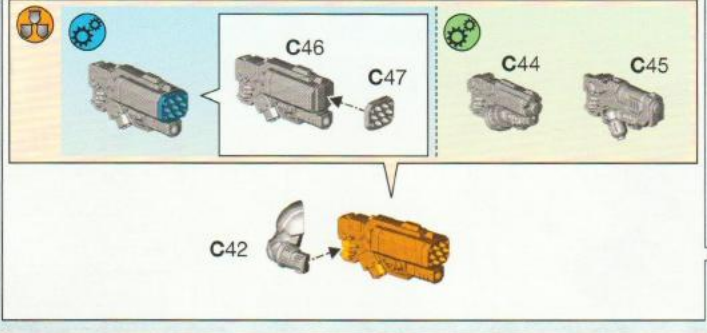

16 c



16 d x2

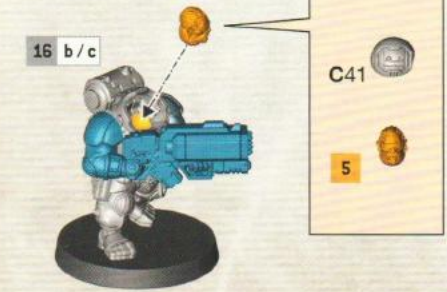

17 a x2



17 b x2

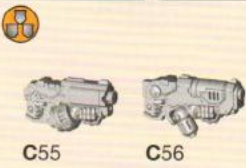

18 a x2

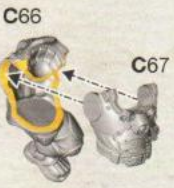

18 b x2



19 x20

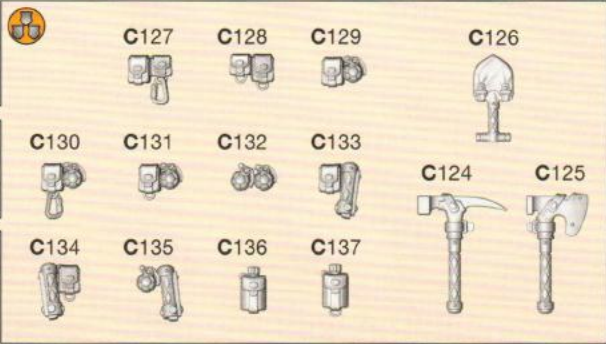

20



21 a x3

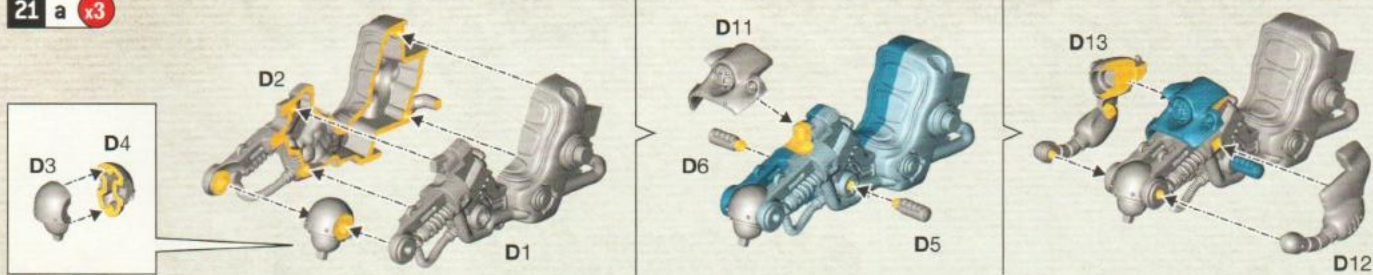

21 b x3



22 a x3

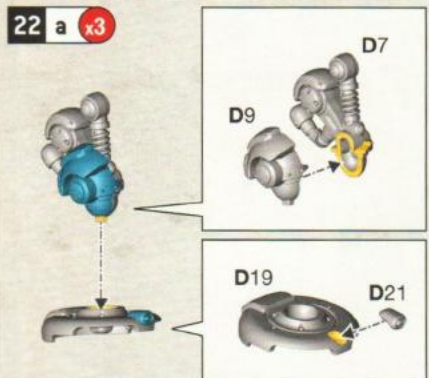

22 b x3

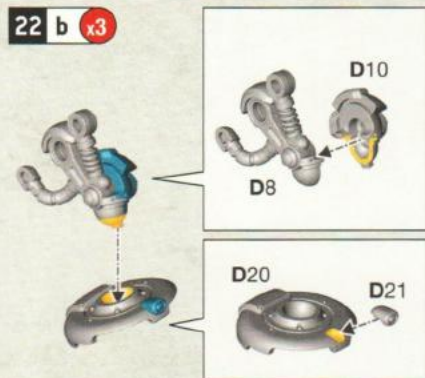

23

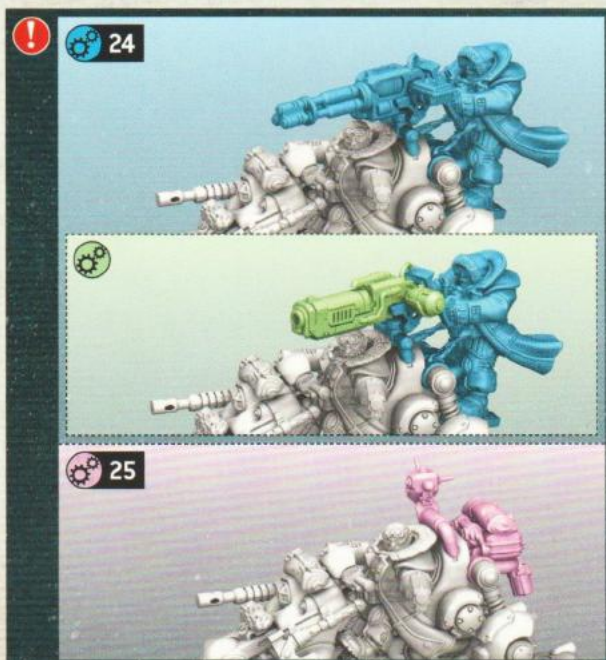
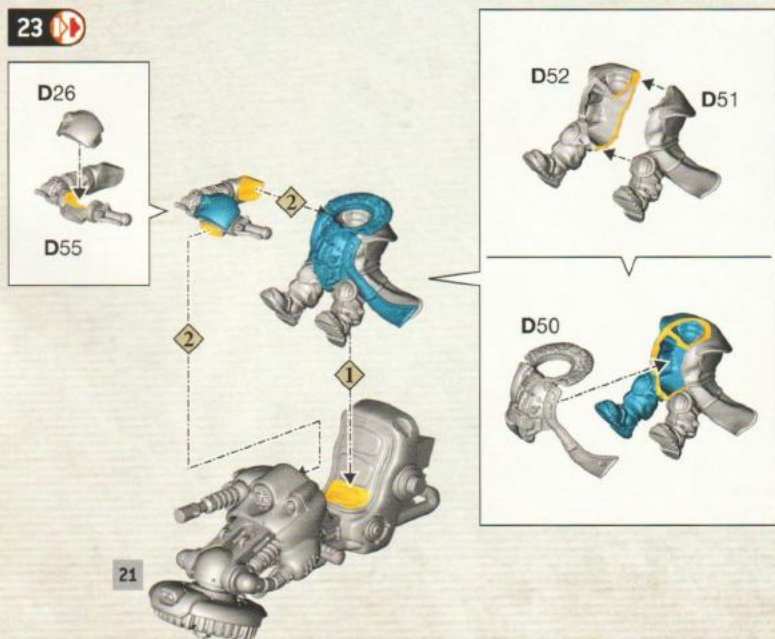

24 a

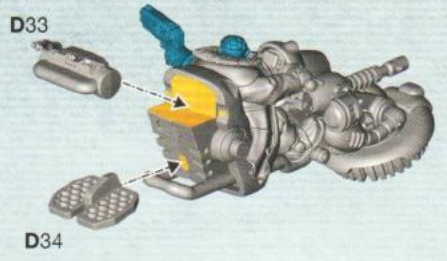

24 b

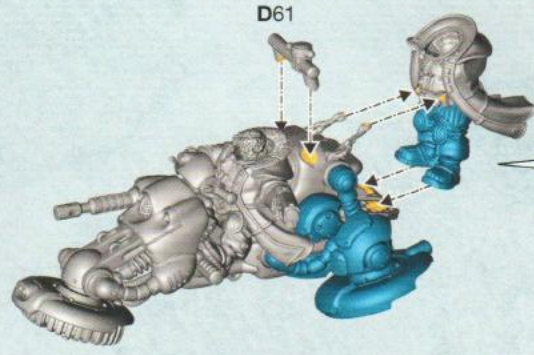
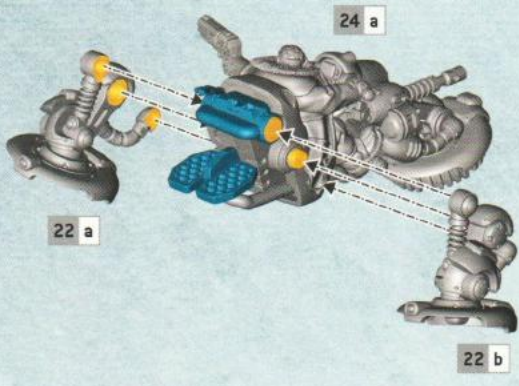

24 c

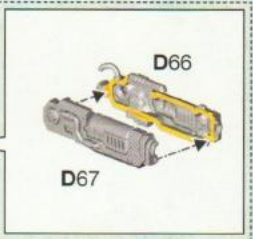
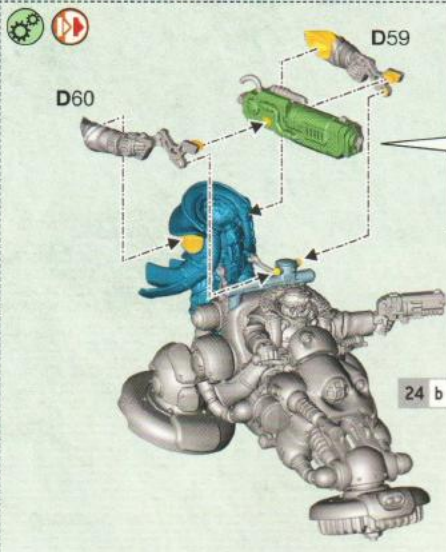
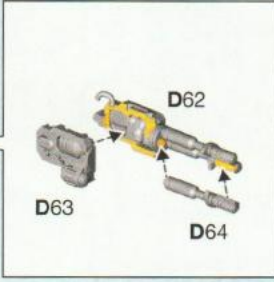
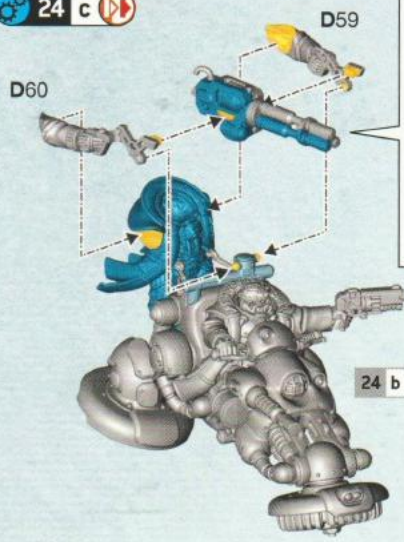

24 d

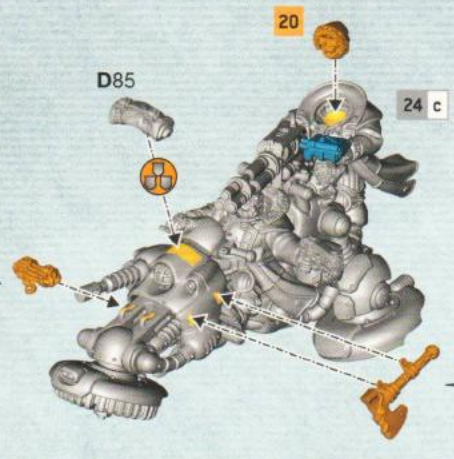

25 a

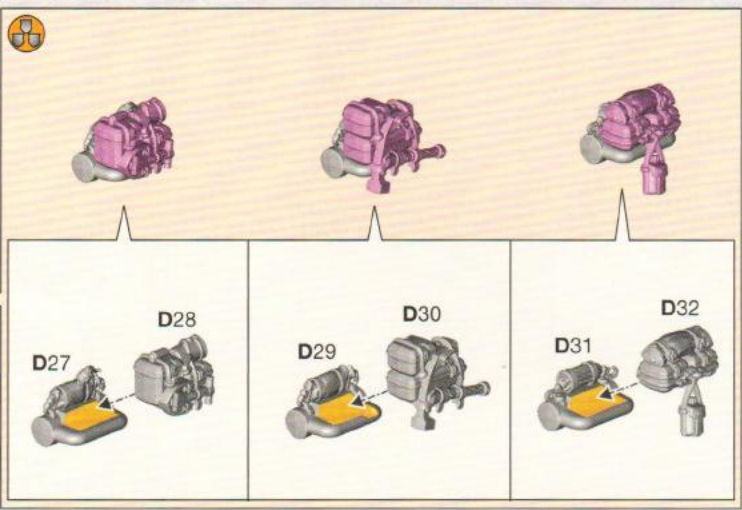
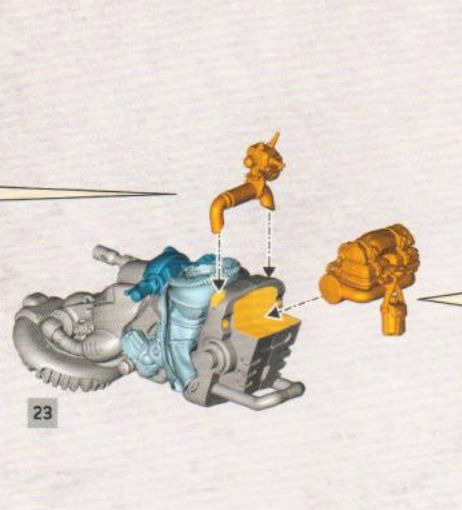

25 b

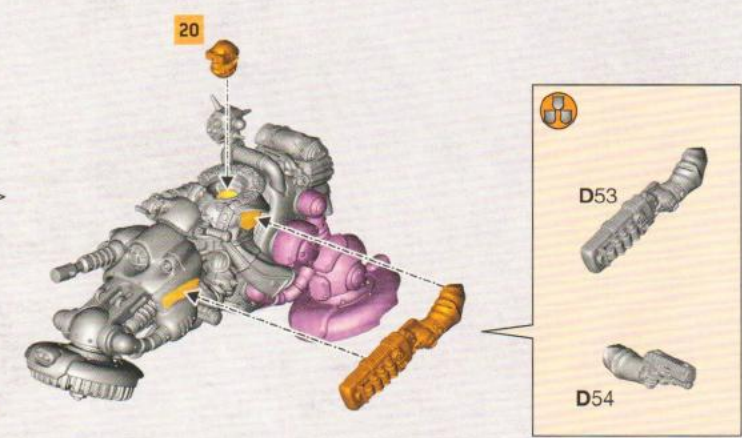
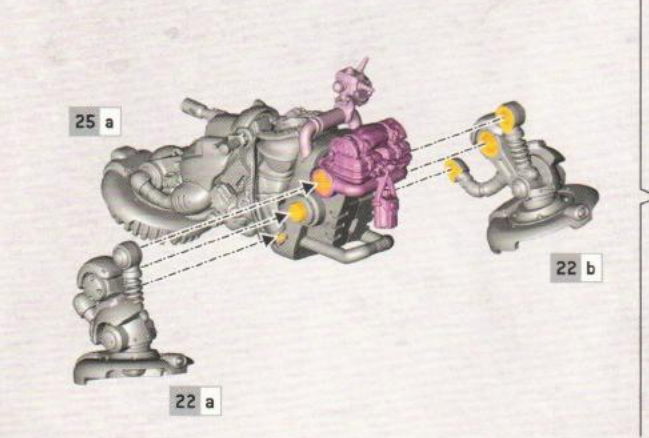

25 c

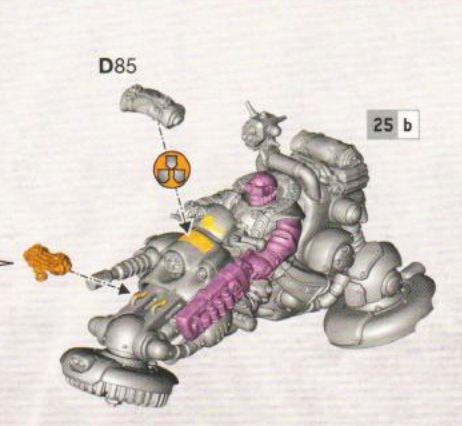

26 a

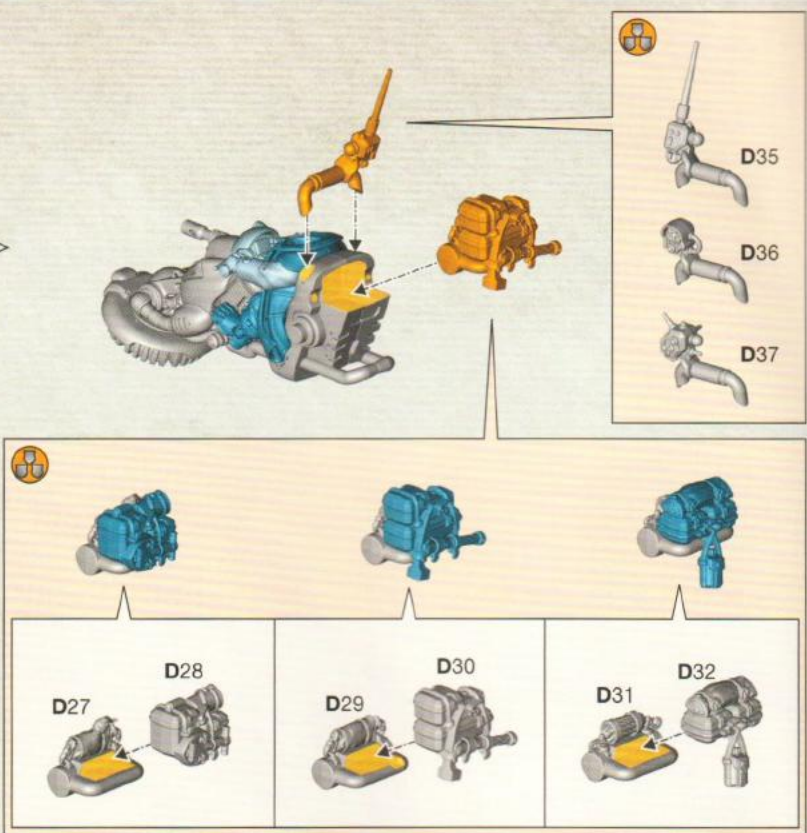
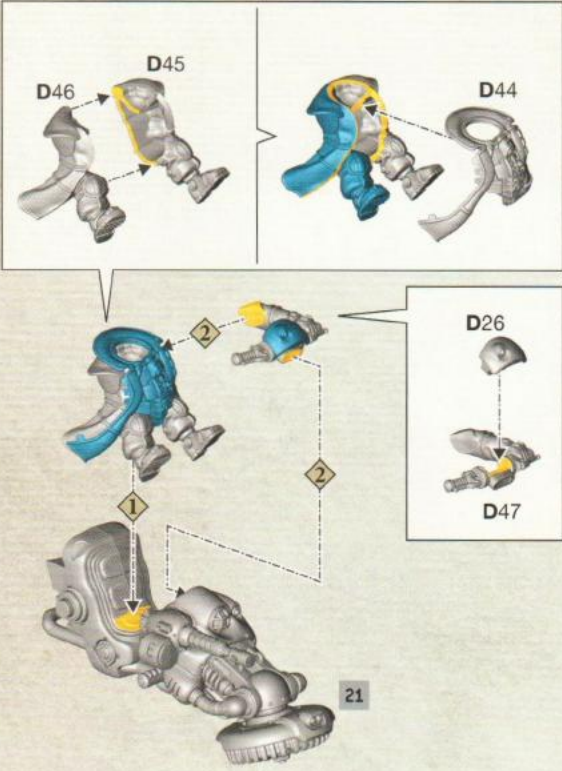

26 b

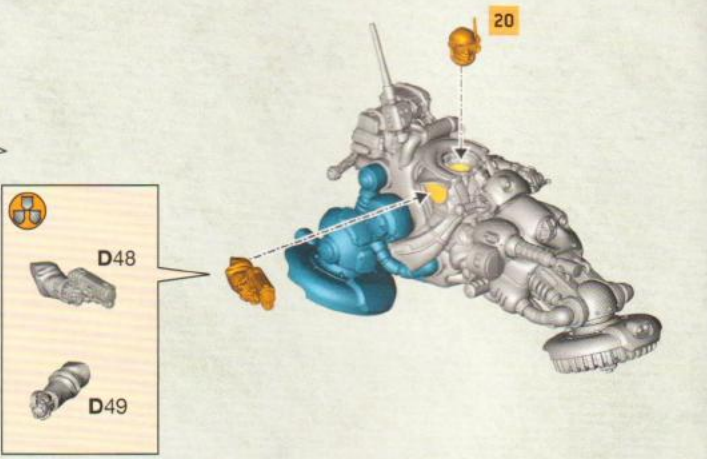
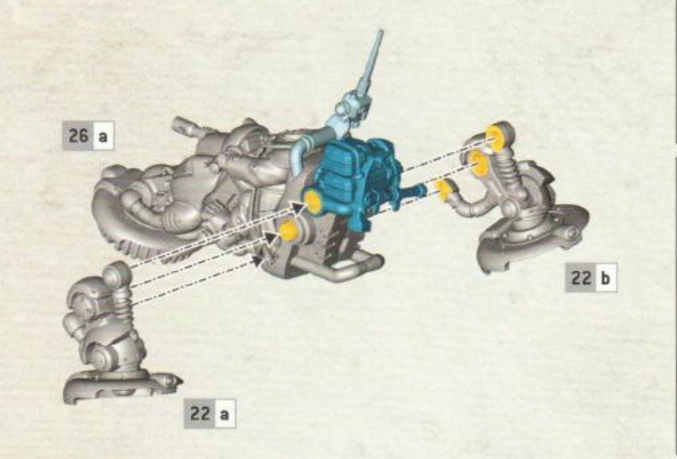

26 c

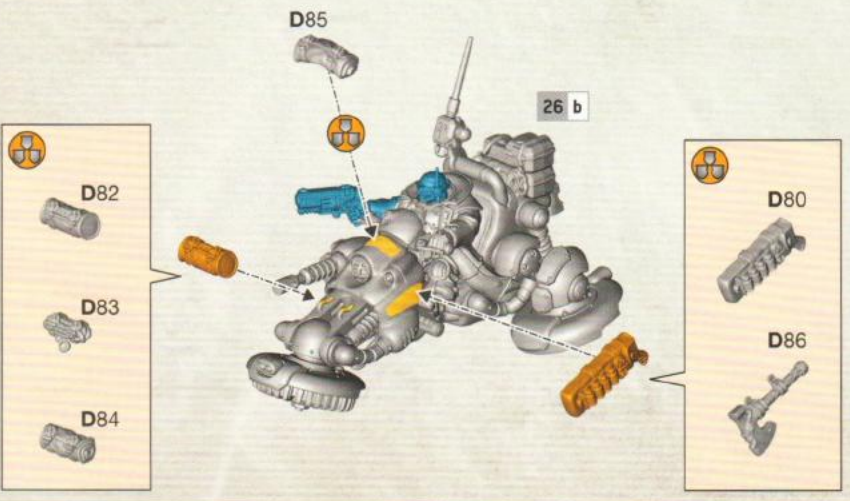

27 a

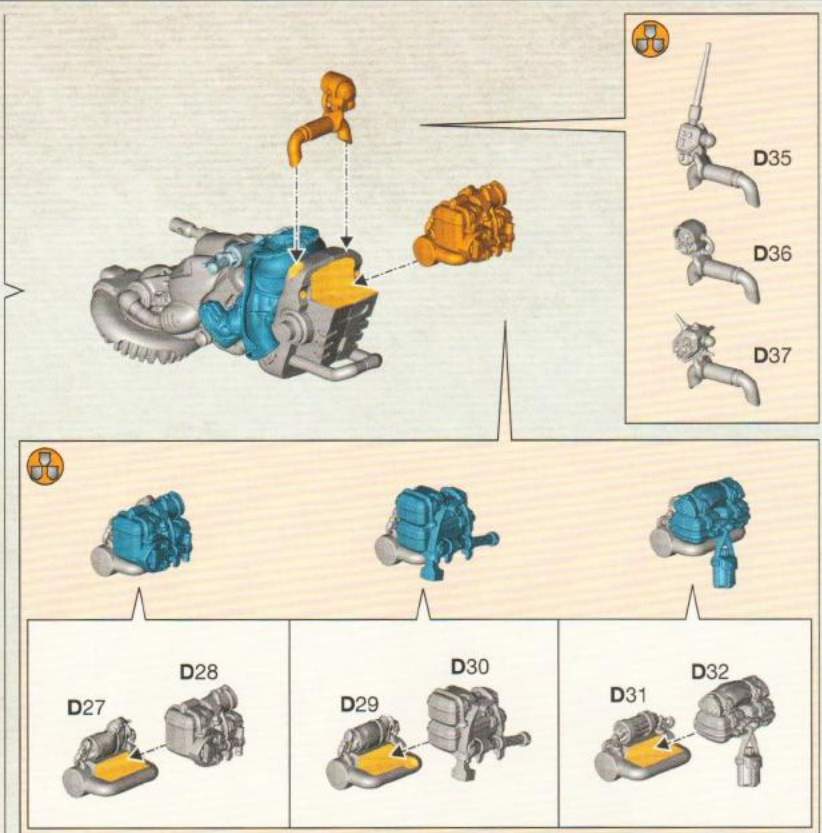
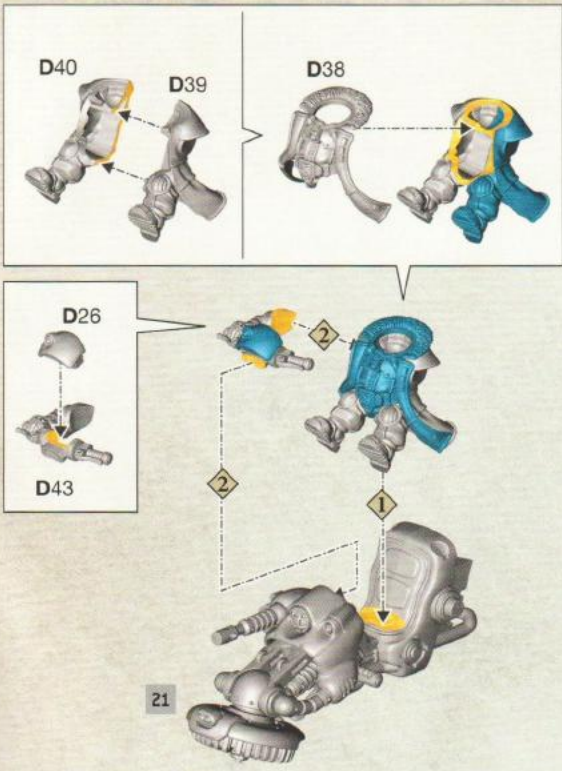

27 b

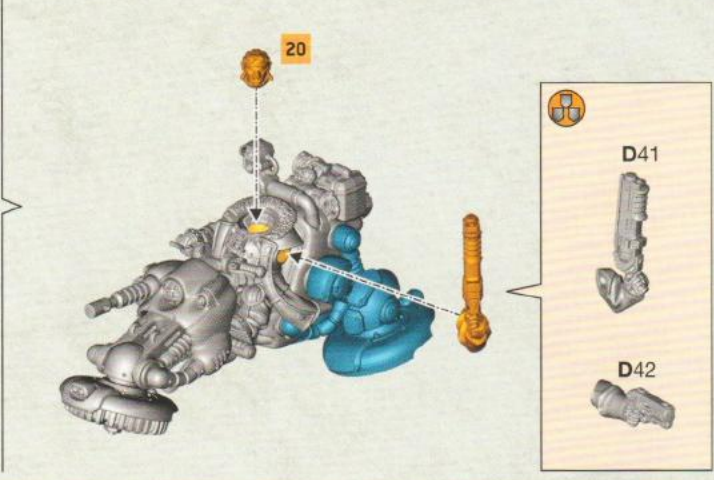
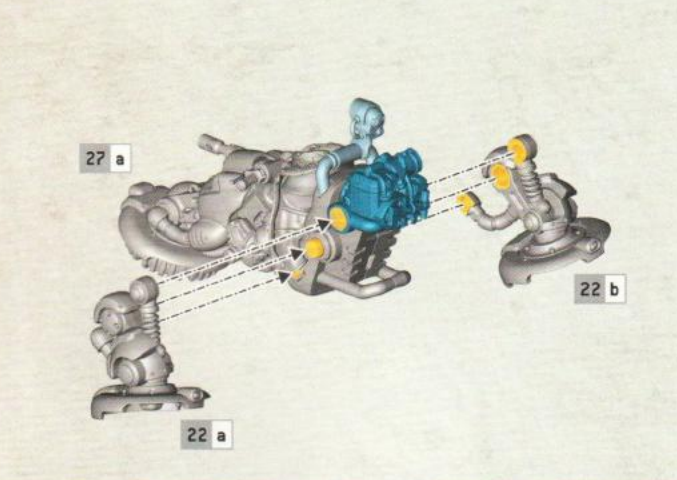

27 c

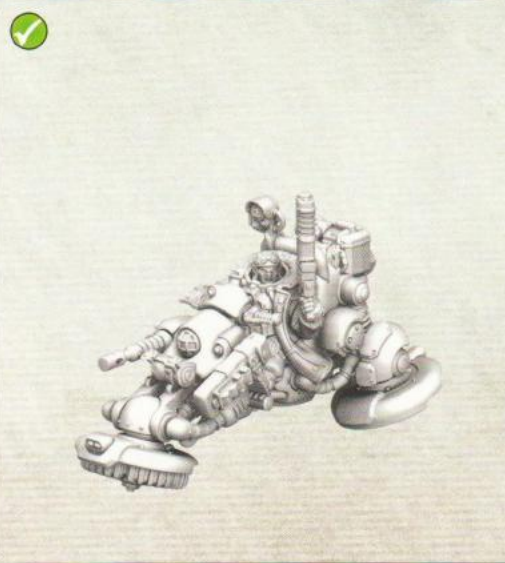
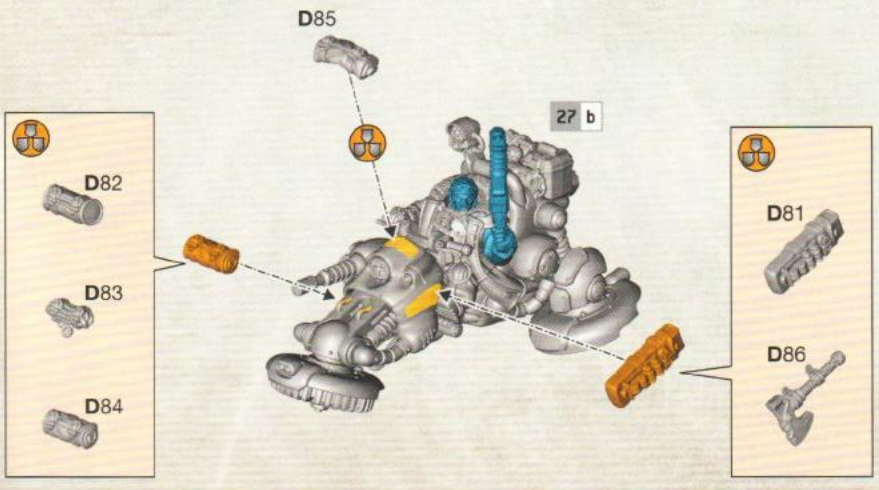

28 a x2



28 b



28 a x2

23 - 27

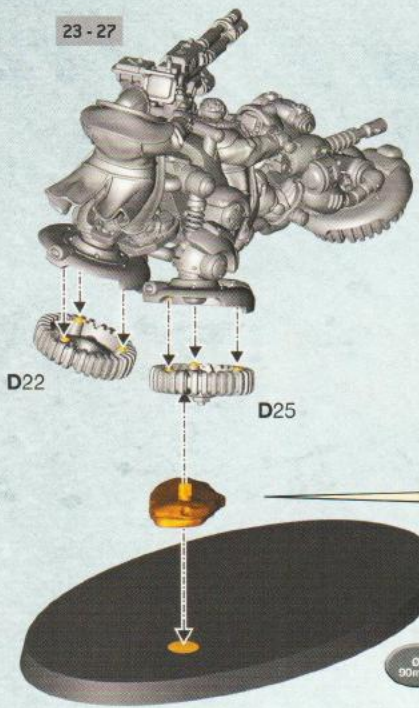

28 b

23 - 27

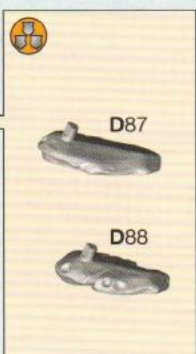
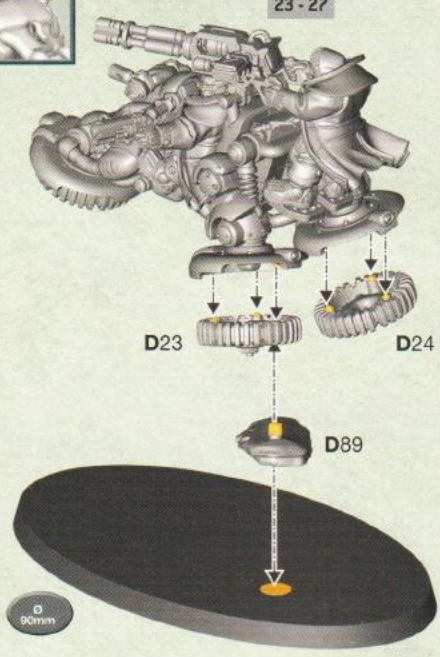

WARHAMMER.COM

Games Workshop Limited, Willow Road, Nottingham, NG7 2WS, UK
© Copyright Games Workshop Limited 2022.

