



Free Downloads of Build Instructions,
Assembly Booklets & How To Guides

BuildInstructions.com

WARHAMMER THE HORUS HERESY

LEGION KRATOS HEAVY ASSAULT TANK

! READ THIS FIRST: Before assembling your model kit, please read through the instructions in this booklet carefully. A pair of plastic cutters is required to remove the plastic components in this kit from their frame. We advise using a mouldline scraping tool to clean up the parts. To assemble your model, you will need plastic glue. Games Workshop sells Citadel Fine Detail Cutters, Citadel Mouldline Removers and Citadel Plastic Glue, but does not recommend these products for use by children under the age of 16 without adult supervision.

À LIRE EN PREMIER : Avant de vous lancer dans l'assemblage de ce kit, veuillez lire attentivement les instructions de ce livret. Une pince coupante est requise pour détacher chaque élément de sa grappe. Nous vous recommandons l'utilisation d'un grattoir pour ébarber les éléments. Pour l'assemblage, vous aurez également besoin de colle plastique. Games Workshop commercialise les Pinces de Précision Citadel, l'Ébarboir Citadel et la Colle Plastique Citadel, mais n'en recommande pas l'utilisation pour des enfants de moins de 16 ans sans la supervision d'un adulte.

LEER ANTES DE MONTAR: Antes de montar el contenido de este kit, lee estas instrucciones cuidadosamente. Te harán falta unas tenazas para plástico a fin de separar las piezas de la matriz. También aconsejamos una herramienta para rebabas a fin de limpiar cada pieza. Para montar la miniatura necesitarás pegamento para plástico. Games Workshop vende Tenazas Citadel, Herramientas para rebabas Citadel y Pegamento para plástico Citadel, pero no recomienda estos productos a menores de 16 años sin la supervisión de un adulto.

LIES DIES ZUERST: Bitte lies diese Anleitung sorgfältig, bevor du mit dem Zusammenbau deines Modells beginnst. Du benötigst einena Kunststoffseitenschneider, um die Kunststoffbauteile aus dem Gussrahmen herauszutrennen, und Kunststoffkleber, um die Miniatur zusammenzubauen. Außerdem empfehlen wir, die Bauteile vorher mit einem Gussgratentferner zu säubern. Games Workshop bietet Präzisions-Kunststoffseitenschneider von Citadel sowie Citadel-Kunststoffkleber an, empfiehlt aber, dass Kinder unter 16 Jahren diese nur unter Aufsicht eines Erwachsenen benutzen.

LEGGI PRIMA QUESTO: Prima di assemblare il tuo modello, leggi le istruzioni di questo libretto con attenzione. Sono necessarie un paio di tronchesine per plastica per staccare i componenti dal loro sprue. Consigliamo di usare un attrezzo apposito per pulire i componenti. Per assemblare il modello avrai bisogno di colla per plastica. Games Workshop vende Tronchesine di precisione Citadel, Attrezzo per ripulire Citadel e Colla per plastica Citadel, ma non consiglia questi prodotti ad un pubblico minore di 16 anni senza la supervisione di un adulto.

优先阅读: 组装模型前, 请先仔细阅读本手册中的说明。需要用模型剪钳将塑料部件从板件上剪下。我们推荐使用合模线清理工具来清理零件。用塑料粘接胶来组装模型。Games Workshop 销售 Citadel 精密剪钳、Citadel 合模线刮刀和 Citadel 塑料粘接胶。但不建议未满 16 岁的儿童在没有成人的监护下使用此类产品。

最初にお読みください: ミニチュアを組み立てる前に、この冊子の説明をよくお読みください。本セット内フレームからプラスチックパーツを切り取るためにプラスチック用ニッパーが必要となります。その後パーツを滑らかにするため、モールドラインを削るためのツールの使用を推奨します。モデルの組み立てには、プラスチック接着剤が必要となります。ゲームズワークショップでは『シタデルファインディテールニッパー』『シタデルモールドライニングリムーバー』『シタデルプラスチック接着剤』を販売していますが、これらは保護者の監督なしでの16歳以下のお子様の使用を推奨しません。

EXPLANATION OF SYMBOLS EXPLICATION DES SYMBOLES EXPLICACIÓN DE SIMBOLOS ERLÄUTERUNG DER SYMBOLE LEGENDA DEI SIMBOLI 符号说明 記号の説明

-  Do not glue the components
Ne pas coller les éléments
No pegar los componentes
Bitte die Teile nicht kleben
Non incollare i componenti
請勿粘膠
接着しないこと。
-  Choice of parts
Choix d'éléments
Modelos de componentes
Auswahl an Teilen
Scelta di componenti
零件選擇
パーツ選択
-  Variant assembly
Variante d'assemblage
Variante de montage
Bauvariante
Assemblaggio alternativo
多种组装方案
組み立てのバリエーション
-  Repeat process
Répéter l'étape
Repetir pasos
Vorgang wiederholen
Ripeti il processo
重复步骤
プロセスを繰り返す
-  Rotate part
Faire pivoter
Girar la pieza
Teil drehen
Ruota il componente
旋转部件
向きを変更
-  Shim for removal
Couper à ras
corta para liberar la pieza
Verbindungsstück entfernen
Rimuovi con un taglierino
切除多余的部件
余計な部分を取り除く
-  Stage complete
Étape terminée
Paso completado
Schritt abgeschlossen
Fase completa
部件组装完成
完了

16+



Citadel Plastic Glue
Colle plastique liquide Citadel
Pegamento para plástico fluido
Citadel-Kunststoffkleber
Colla per plastica fluida Citadel
Citadel 塑料粘接剂
シタデルプラスチック接着剤流し込みタイプ



Citadel Fine Detail Cutters
Pinces de précision Citadel
Tenazas Citadel
Citadel-Seitenschneider
Tronchesine di precisione Citadel
Citadel 精密剪钳
シタデルファインディテールニッパー



Citadel Mouldline Remover
Ébarboir Citadel
Herramienta para rebabas Citadel
Gussgratentferner
Atrezzo per ripulire Citadel
Citadel 合模线刮刀
シタデルモールドラインリムーバー



CITADEL
MINIATURES

© Copyright 2022, Games Workshop Ltd. All rights reserved.



LEGION KRATOS HEAVY ASSAULT TANK

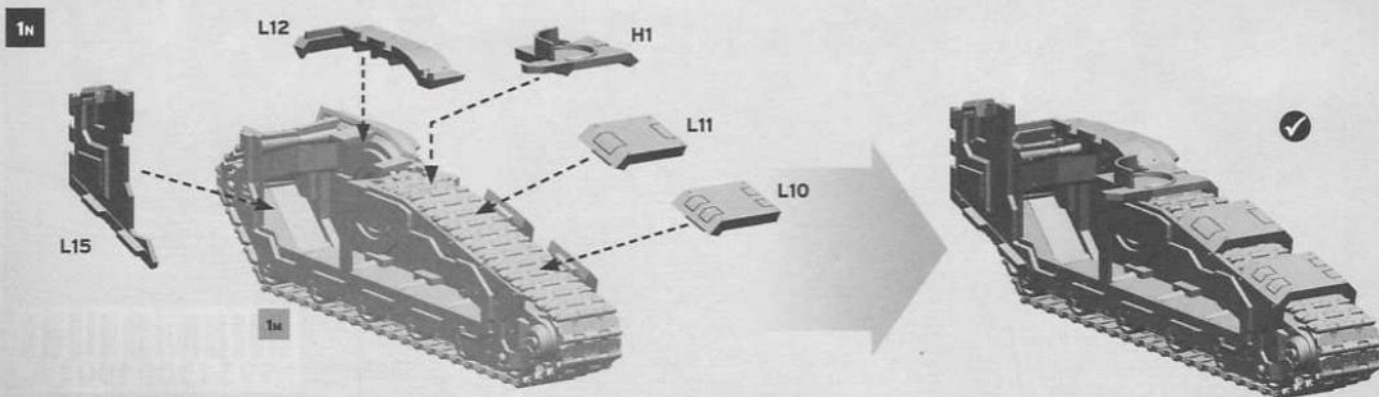
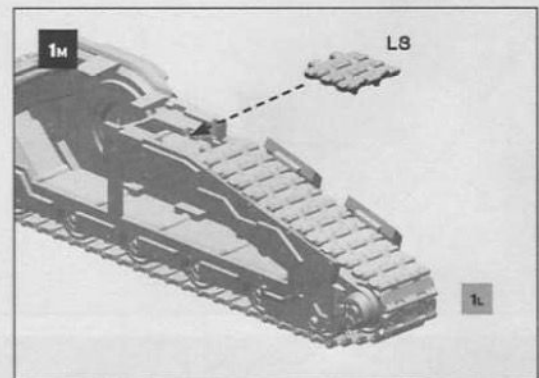
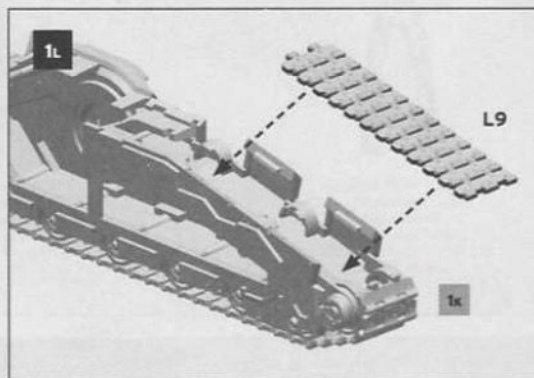
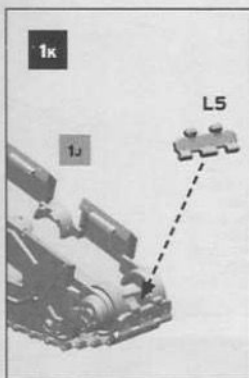
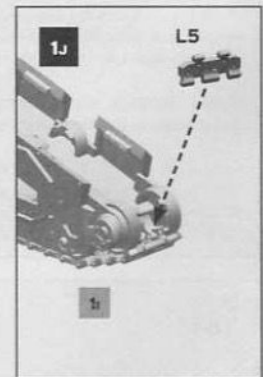
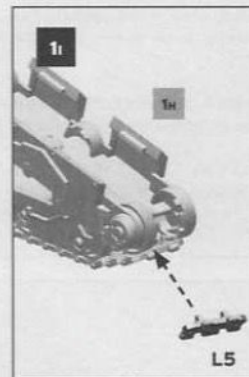
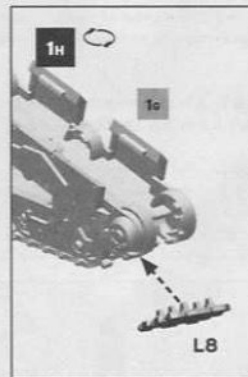
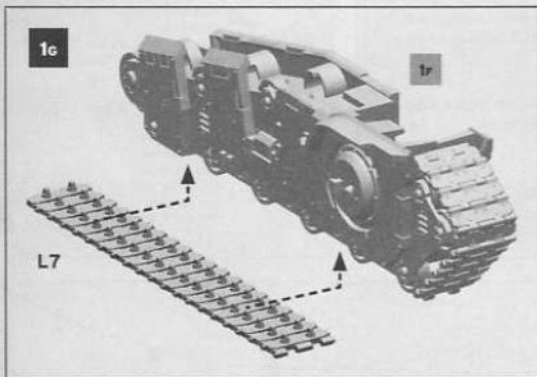
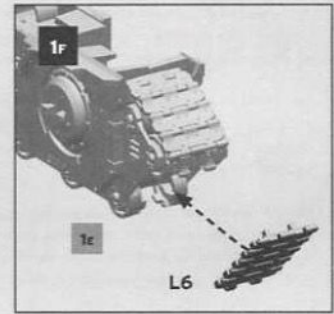
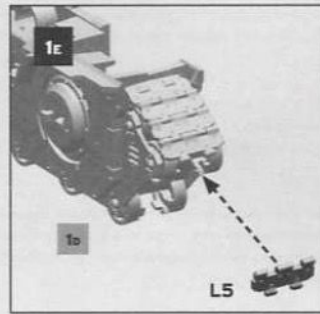
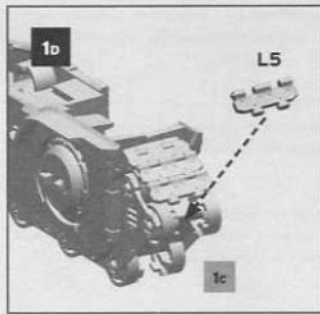
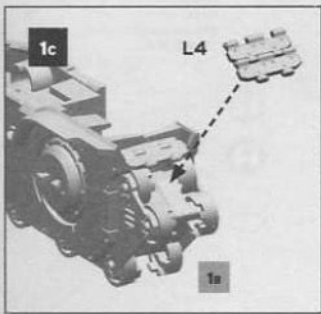
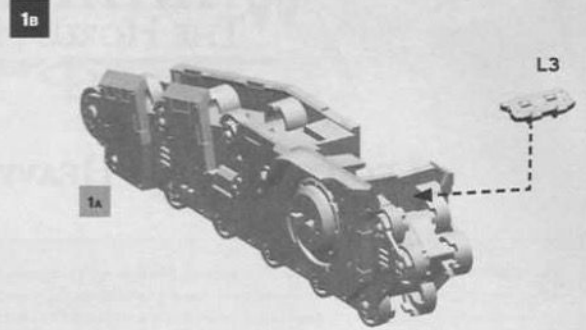
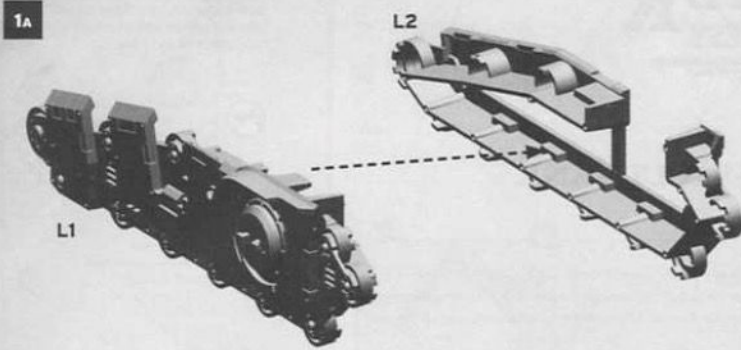

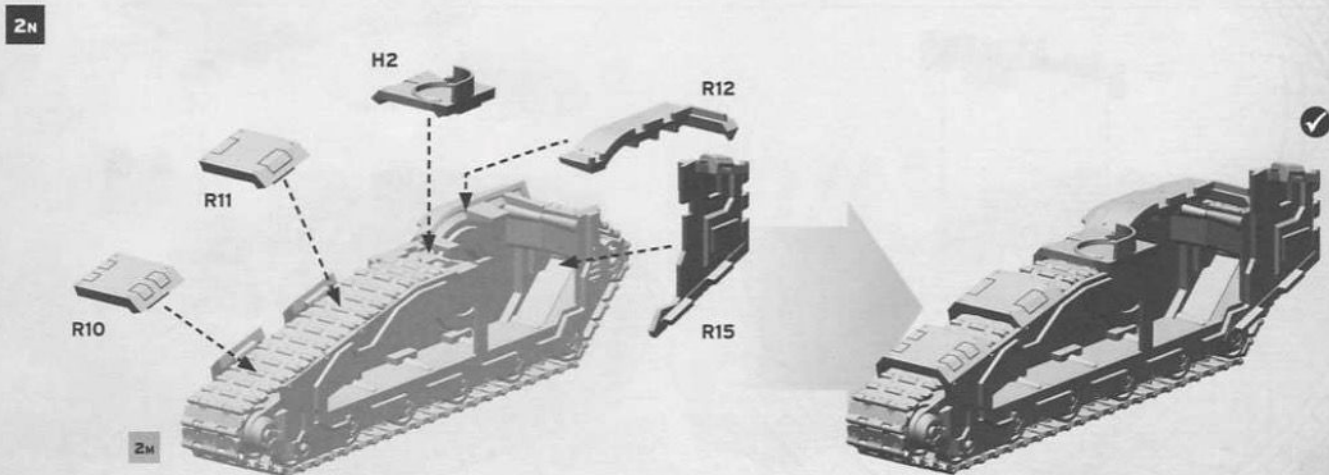
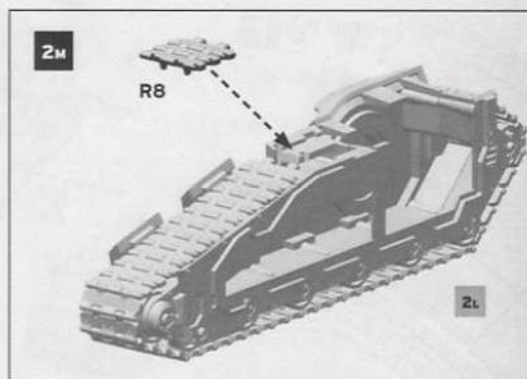
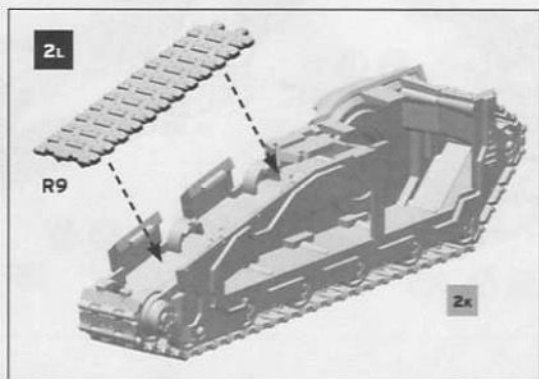
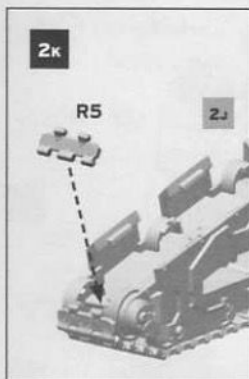
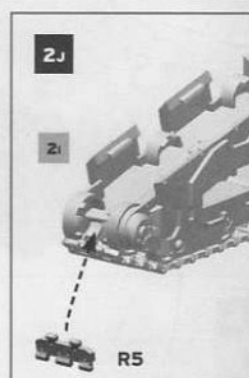
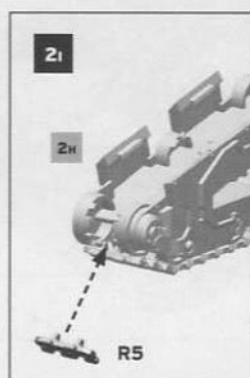
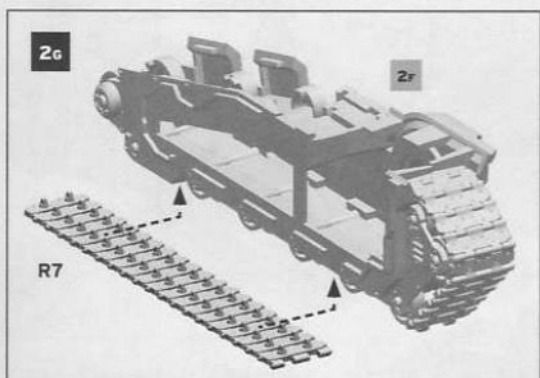
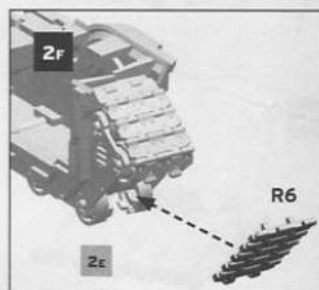
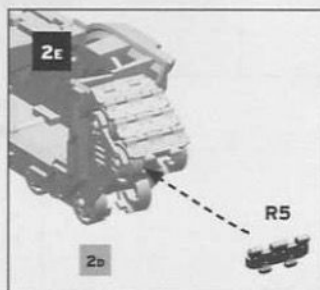
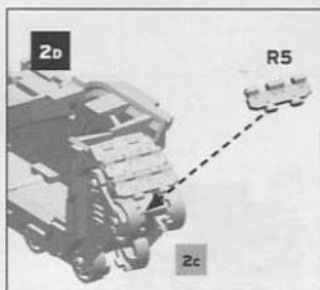
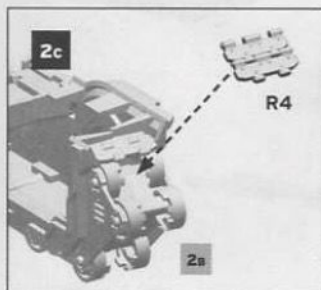
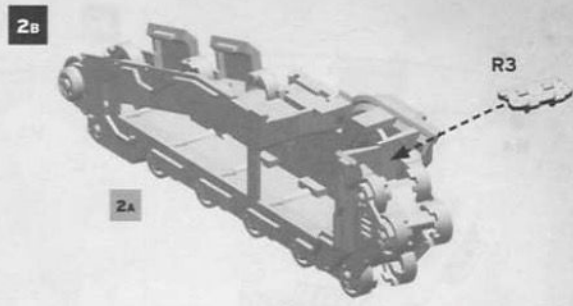
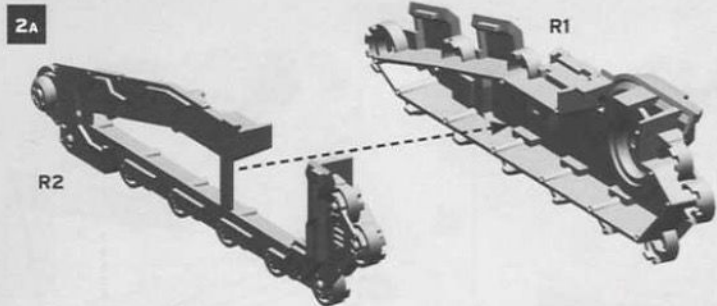

3A

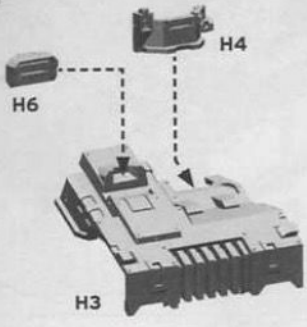

3B

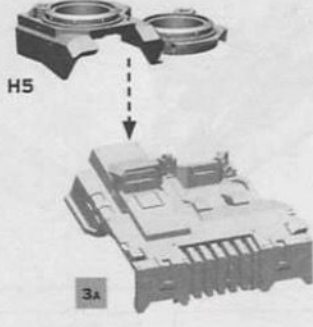

3C

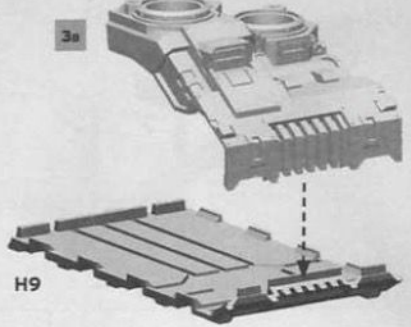

3D

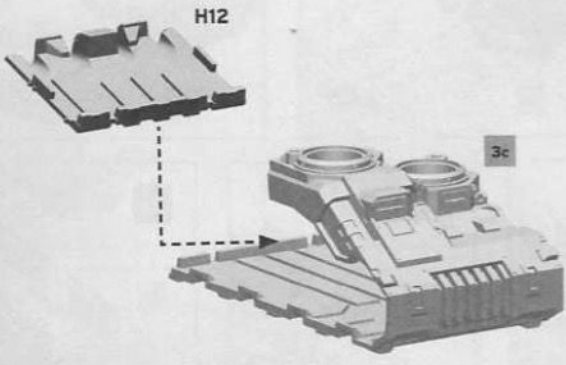

3E

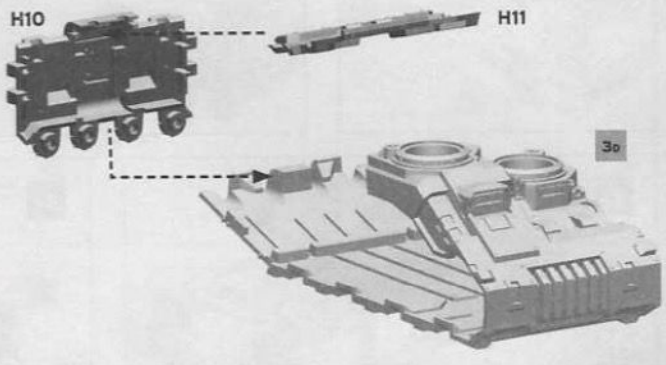

3F

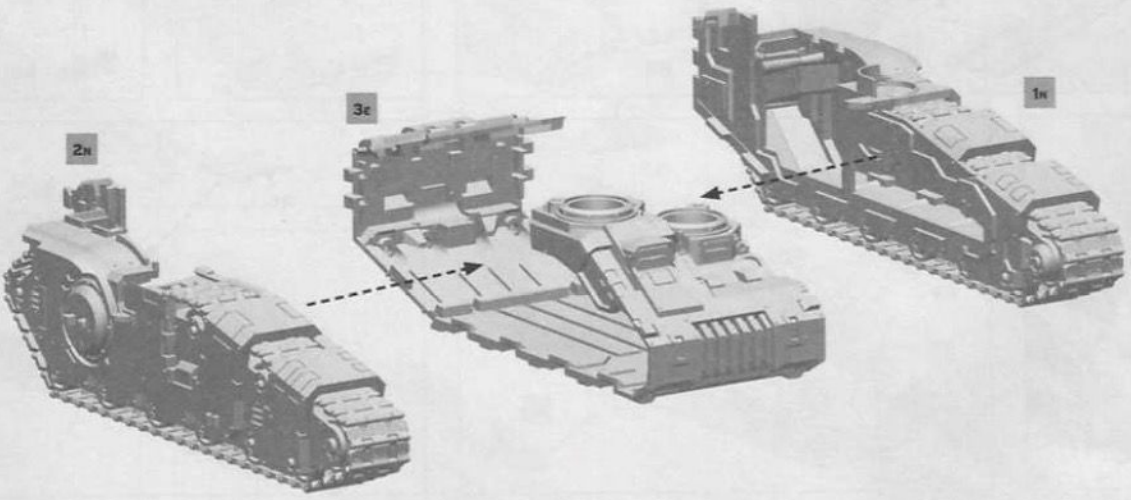

3G

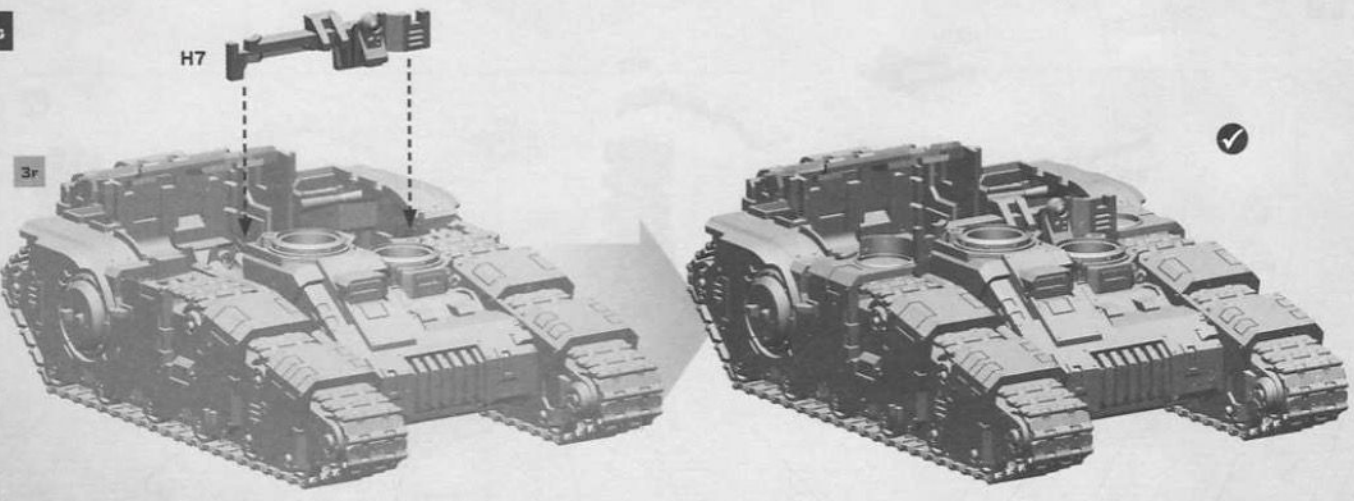

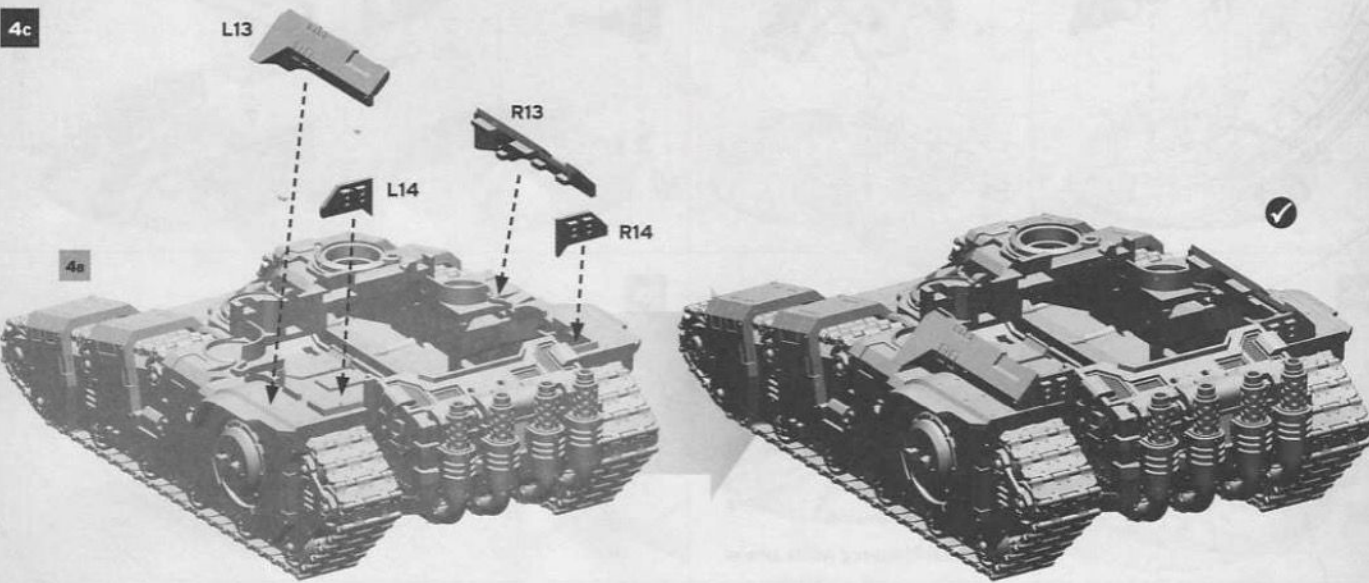
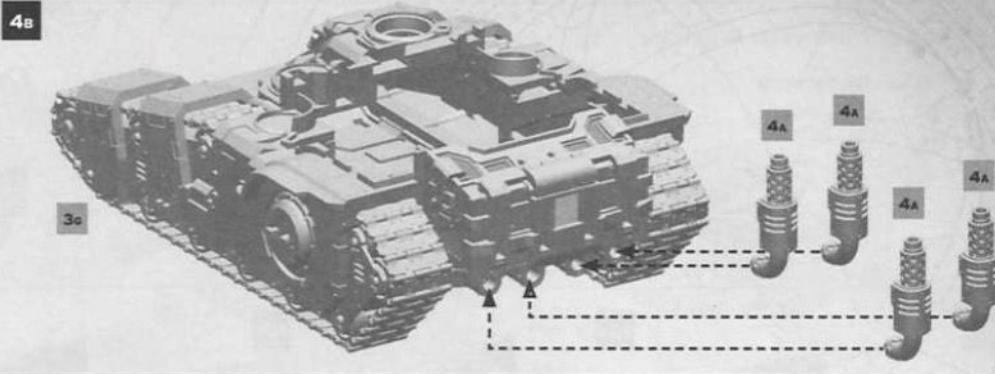
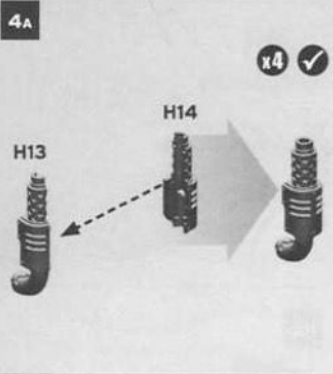

HULL MOUNTED WEAPONS

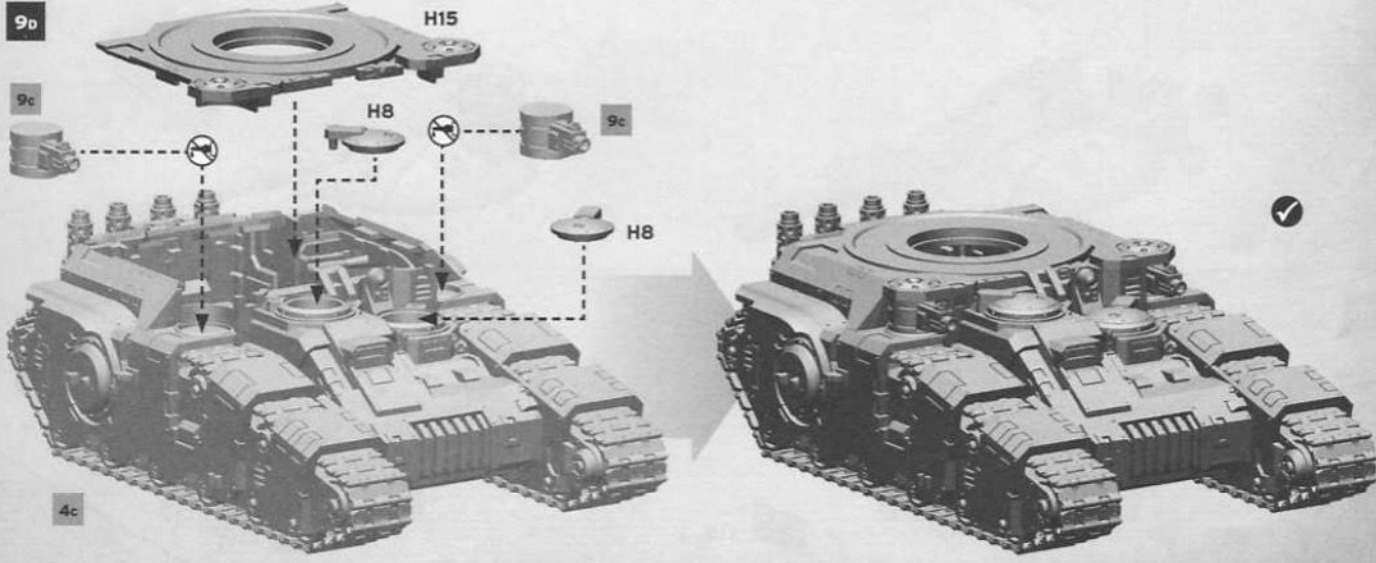
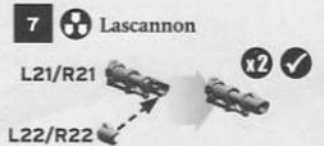

TURRET MOUNTED WEAPON

Kratos Battlecannon

Melta Blast-gun

Volkite Cardanelle

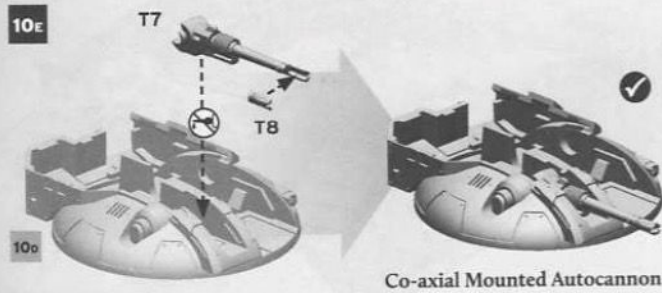
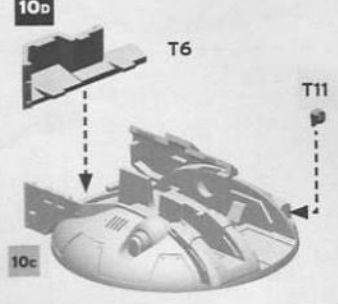
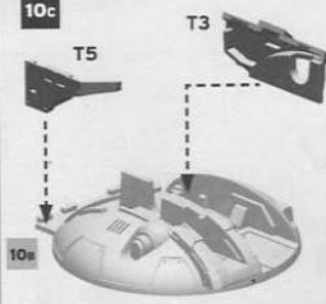
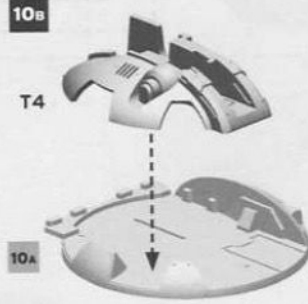
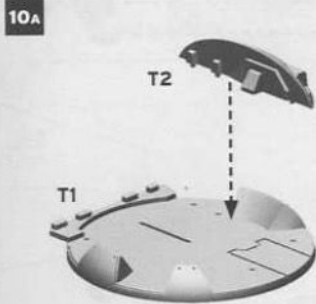

Kratos Battlecannon

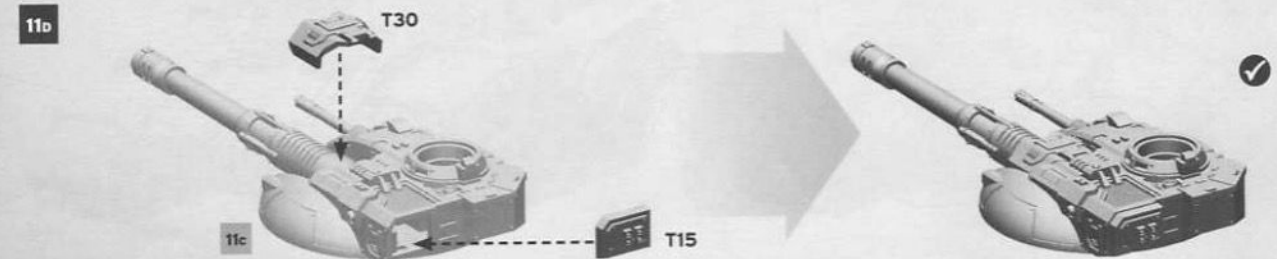
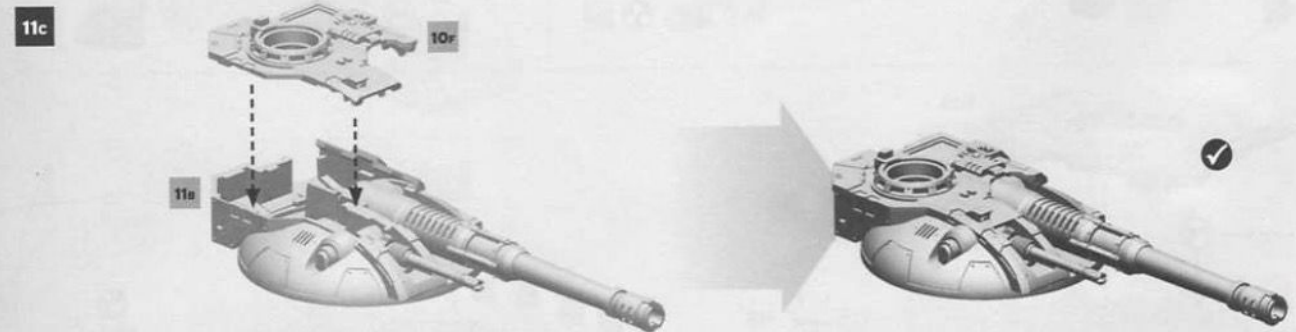

Melta Blast-gun

12A



12B

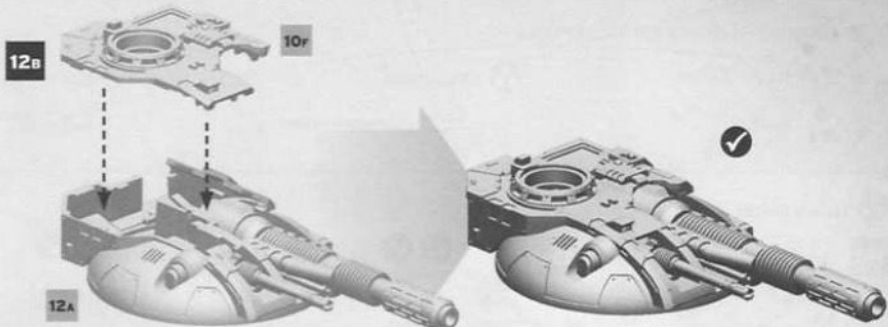

12c

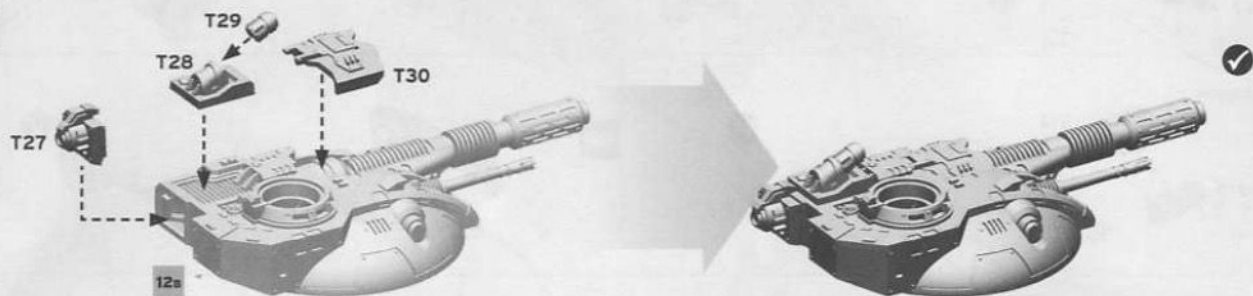

Volkite Cardanelle

13A

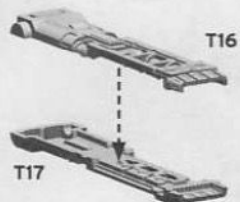

13B

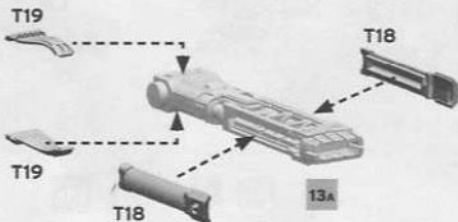

13c

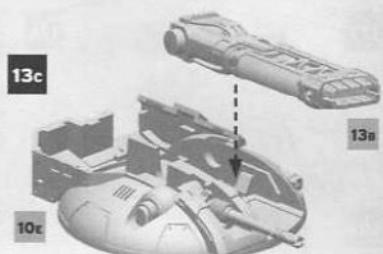

13b

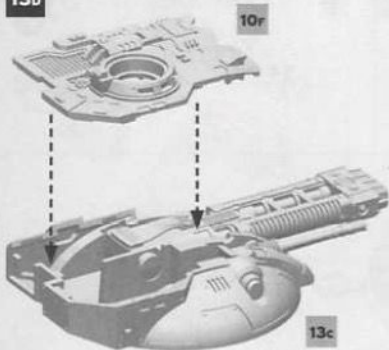

13E



13F

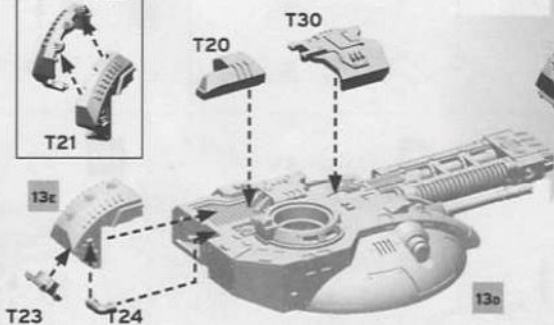

14



SPONSON MOUNTED WEAPONS

Heavy Bolter



Lascannon



Heavy Flamer



Volkite Culverin



Heavy Bolter

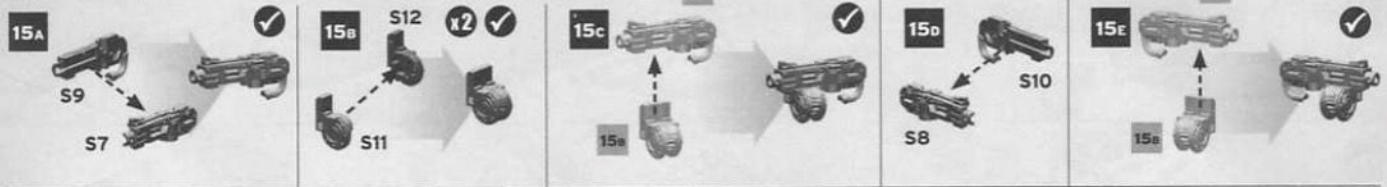

Lascannon



Heavy Flamer

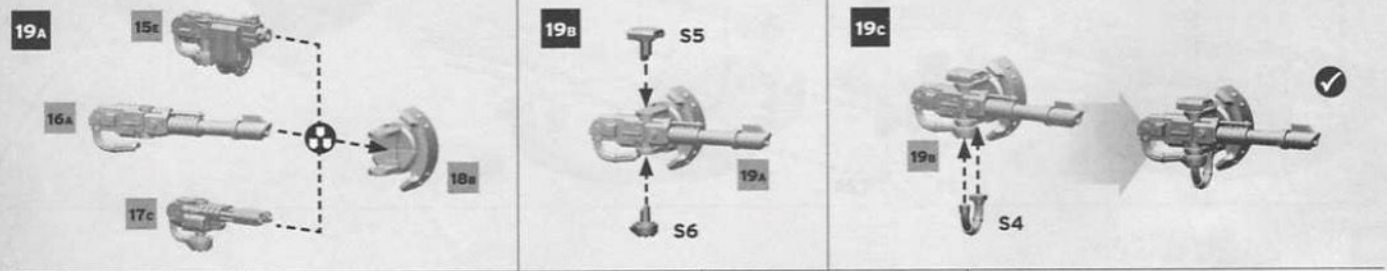
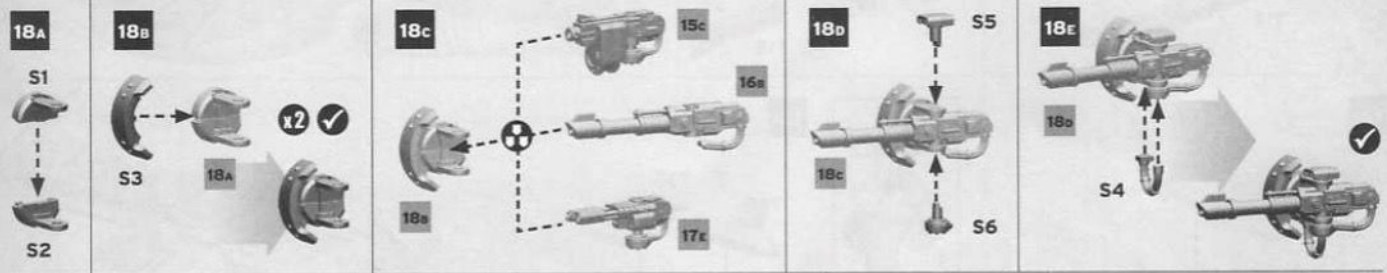
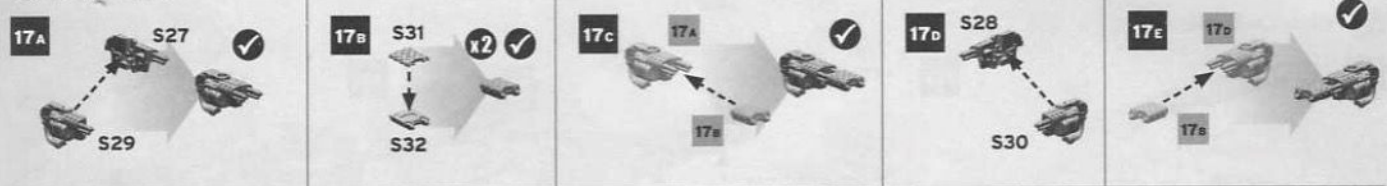

Volkite Culverin

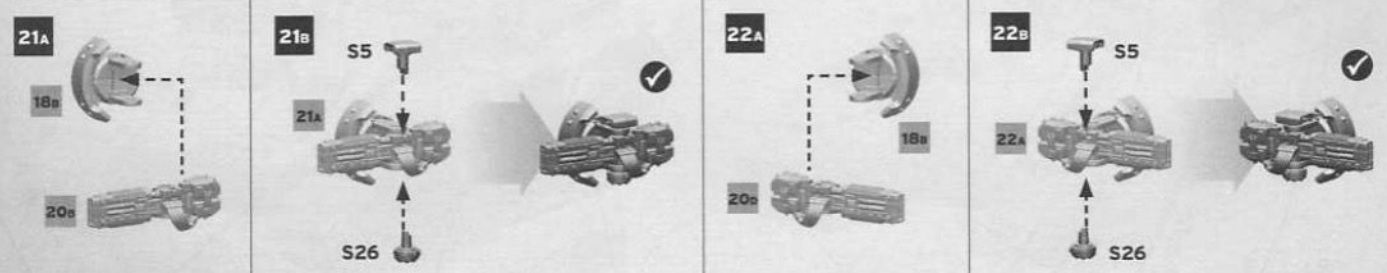

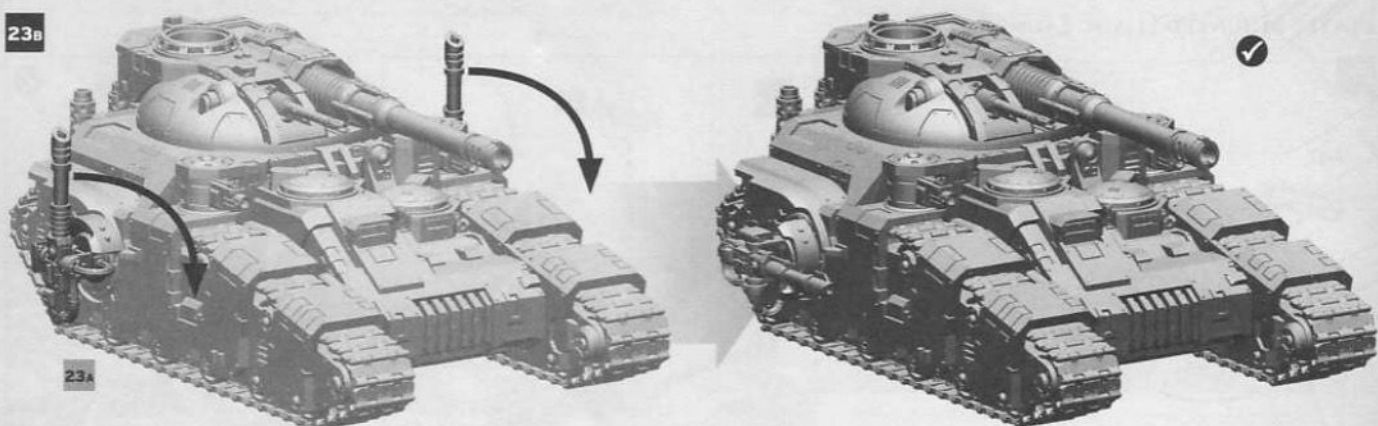
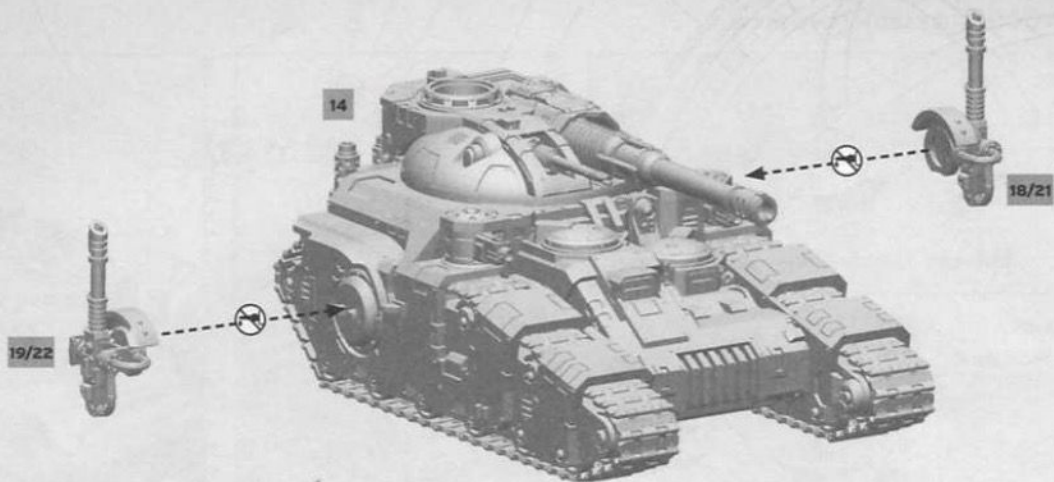

24A HUNTER-KILLER MISSILE

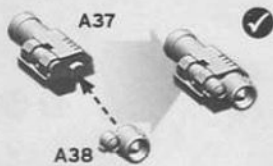

24B SMOKE LAUNCHER

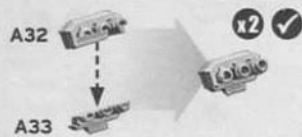

24c SEARCHLIGHT

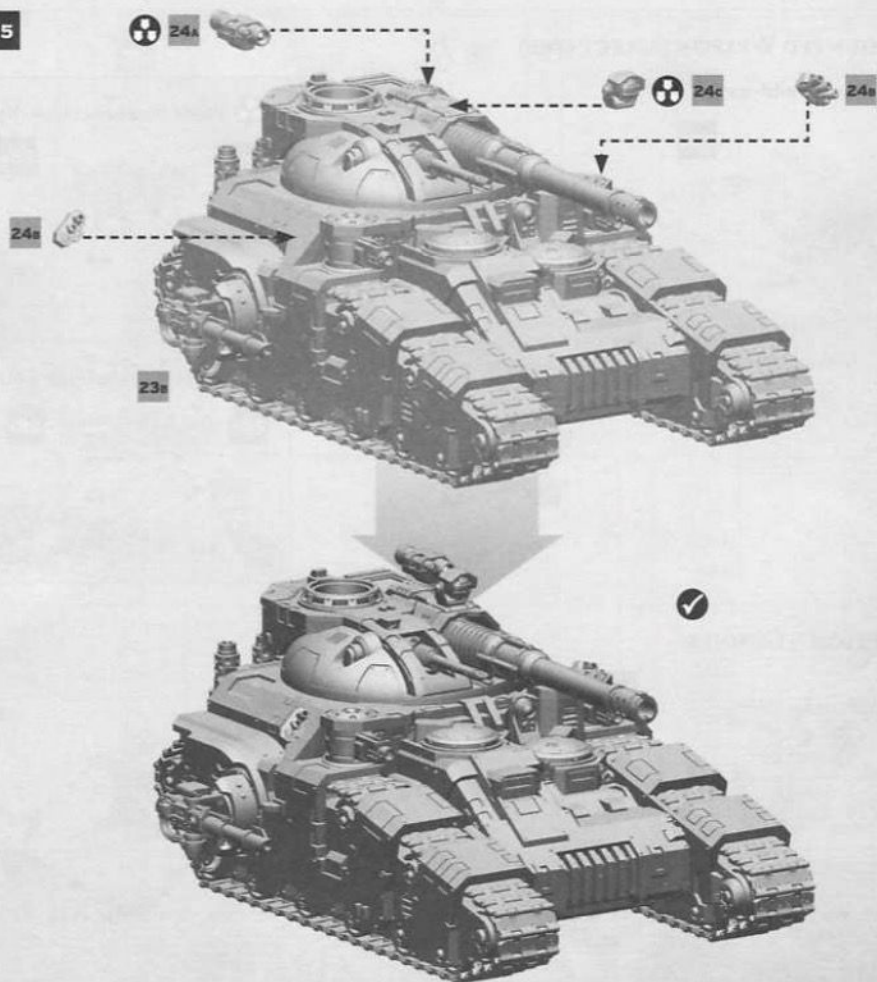
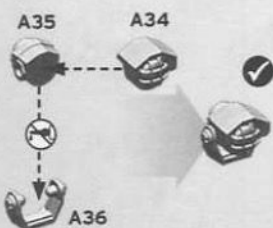

PINTLE MOUNTED COMBI-WEAPON (ANY TYPE)

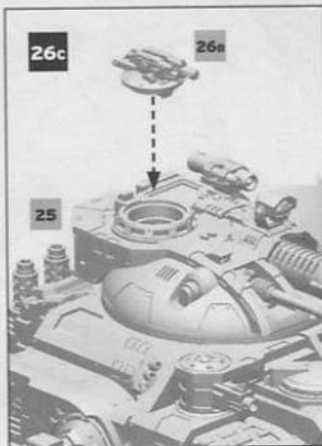
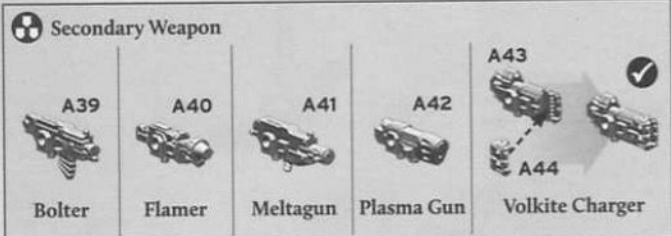

PINTLE MOUNTED HAVOC LAUNCHER

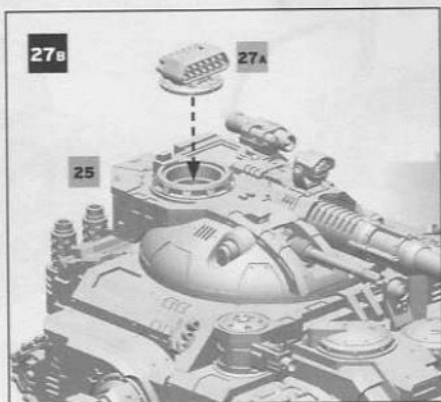
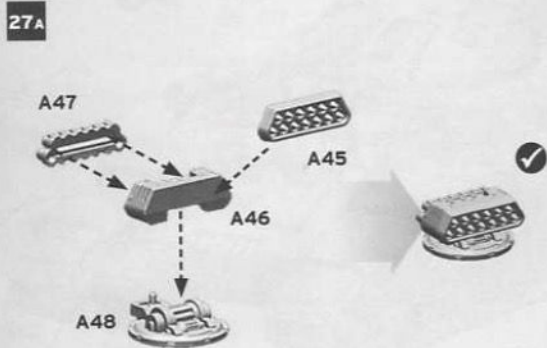

PINTLE MOUNTED WEAPON (SELECT ONE)

Pintle Mounted Multi-melta

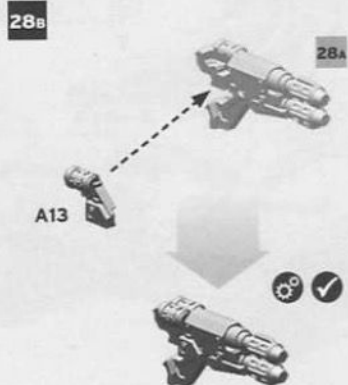
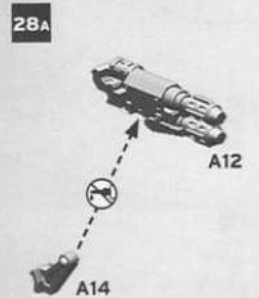

Pintle Mounted Heavy Bolter

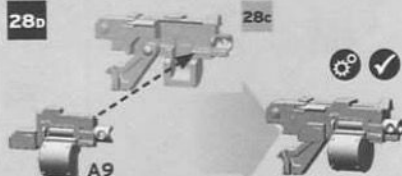

Pintle Mounted Heavy Flamer



HATCH OPTION - GUNNER

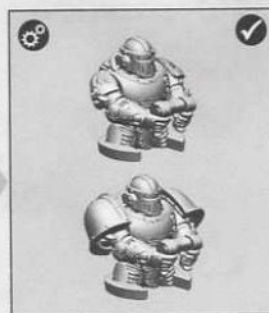
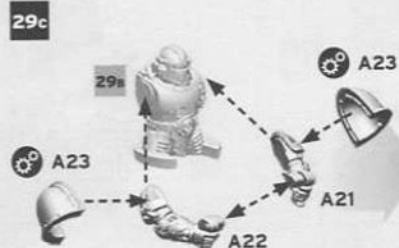
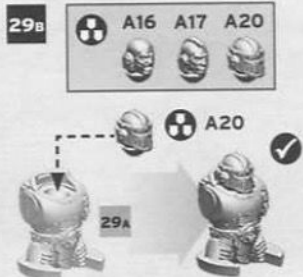
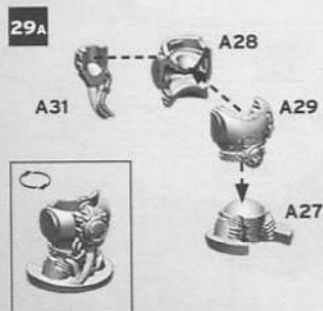

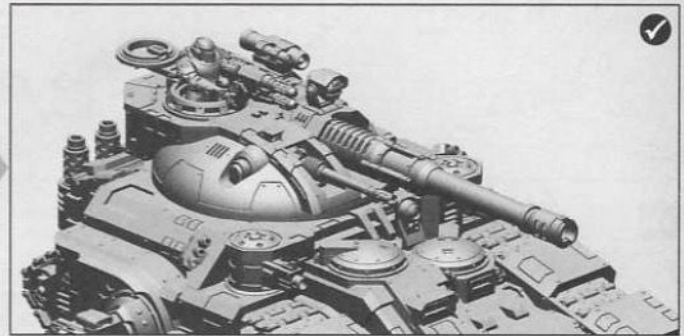
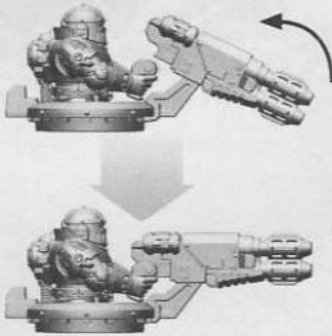
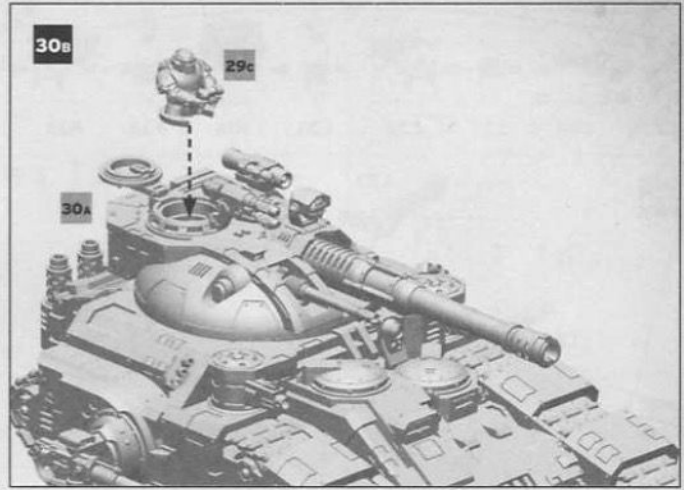
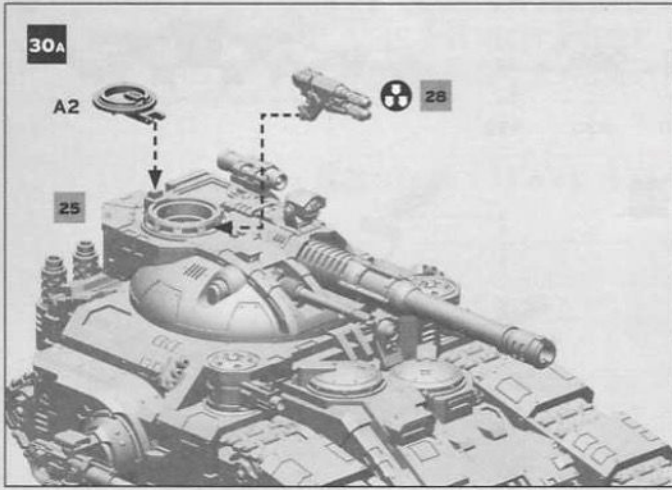

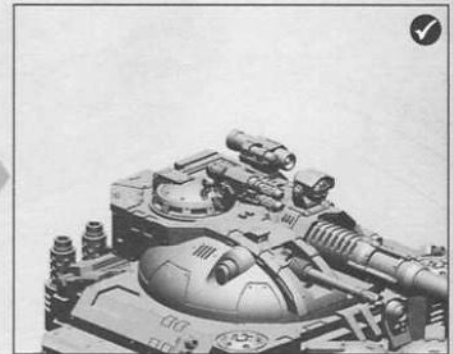
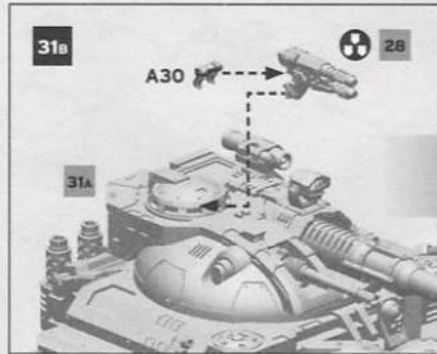
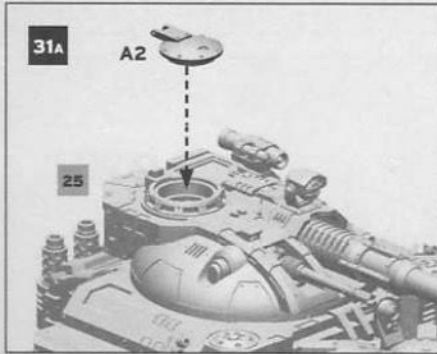

HATCH OPTION - CLOSED HATCH

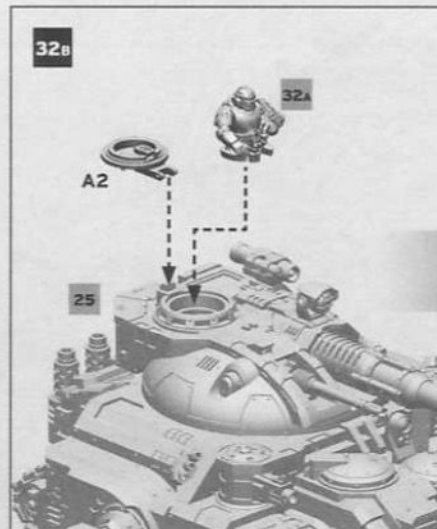
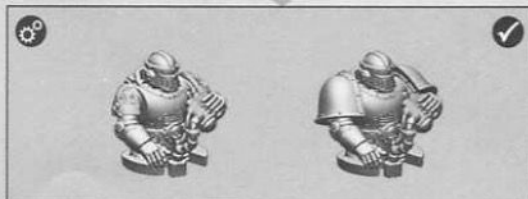
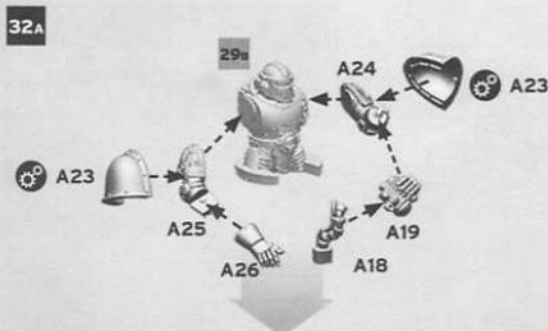

HATCH OPTION - COMMANDER



33A  DOZER BLADE

