



Free Downloads of Build Instructions,
Assembly Booklets & How To Guides

BuildInstructions.com

WARHAMMER
40,000

KILL TEAM

SKIRMISH COMBAT
IN THE 41ST MILLENNIUM

INTO THE DARK

1 a

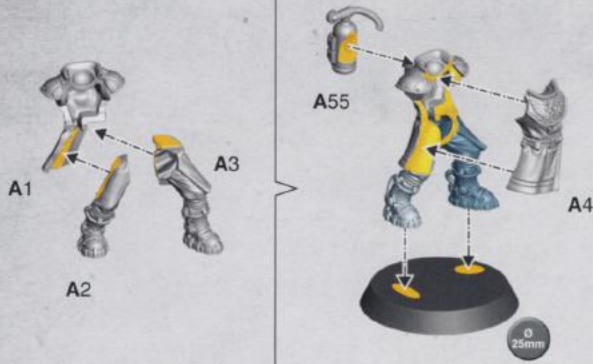

1 b



Navis Sergeant-at-Arms
Sergent d'Armes Navis
Sergento de la Armada
Navis-Waffenmaat
Sergente d'Arma del Navis
Навис Сержант-оружейник
ネイヴィス・サージェント・アット・アームズ
海軍武装卒士

1 c



Navis Sergeant-at-Arms
Sergent d'Armes Navis
Sergento de la Armada
Navis-Waffenmaat
Sergente d'Arma del Navis
Навис Сержант-оружейник
ネイヴィス・サージェント・アット・アームズ
海軍武装卒士

1 b



1 c

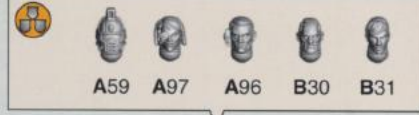

2 a

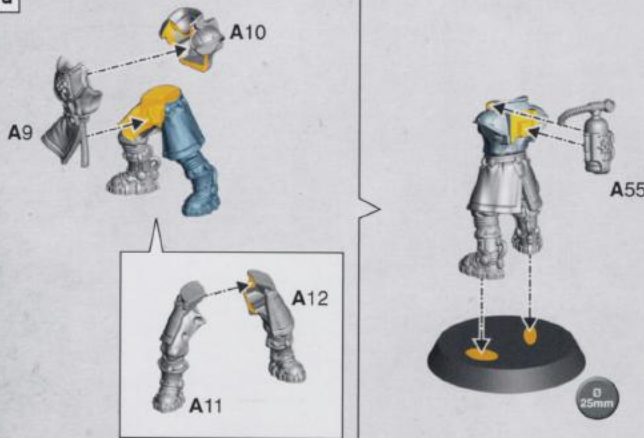

2 b



Navis Armsman
Homme d'Armes Navis
Infante de la Armada
Navis-Flottensoldat
Uomo d'Arme del Navis
Навис Боец
ネイヴィス・アームズマン
海軍船兵

2 c-d



Navis Surveyor
Gonimètreur Navis
Prospector de la Armada
Navis-Späher
Scandagliatore del Navis
Навис Разведчик
ネイヴィス・サーベイヤー
海軍偵測員

2 b

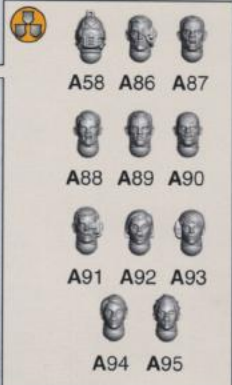

2 c

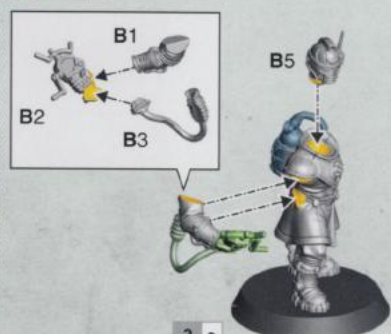

2 d

Navis C.A.T. Unit
 Unité C.H.A.T. Navis
 Unidad G.A.T.O. de la Armada
 Navis-M.A.U.S.-Einheit
 U.O.C. del Navis
 Навис К.О.Т. отряд
 ネイヴィス・C.A.T.ユニット
 海軍C.A.T.単位

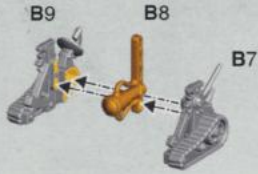
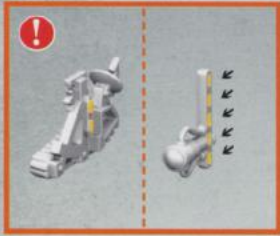

3 a

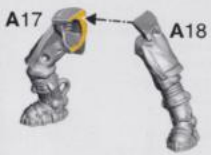

3 b



Navis Armsman
 Homme d'Armes Navis
 Infante de la Armada
 Navis-Flottensoldat
 Uomo d'Arme del Navis
 Навис Боец
 ネイヴィス・アームズマン
 海軍船兵

3 c



Navis Axejack
 Abatteur Navis
 Hachero de la Armada
 Navis-Axtträger
 Mano d'Ascia del Navis
 Навис Разитопор
 ネイヴィス・アックスジャック
 海軍巨斧手

3 b

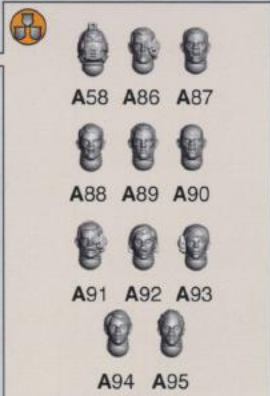

3 c



4

Navis Armsman | Homme d'Armes Navis | Infante de la Armada | Navis-Flottensoldat | Uomo d'Arme del Navis | Навис Боец | ネイヴィス・アームズマン | 海軍船兵

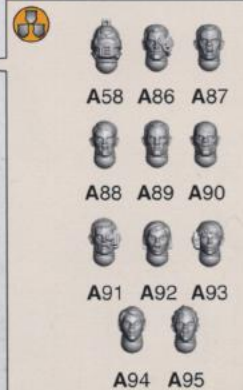
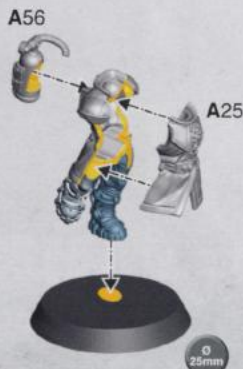
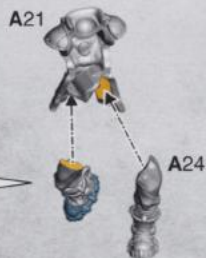



- A58 A86
- A87 A88 A89
- A90 A91 A92
- A93 A94 A95

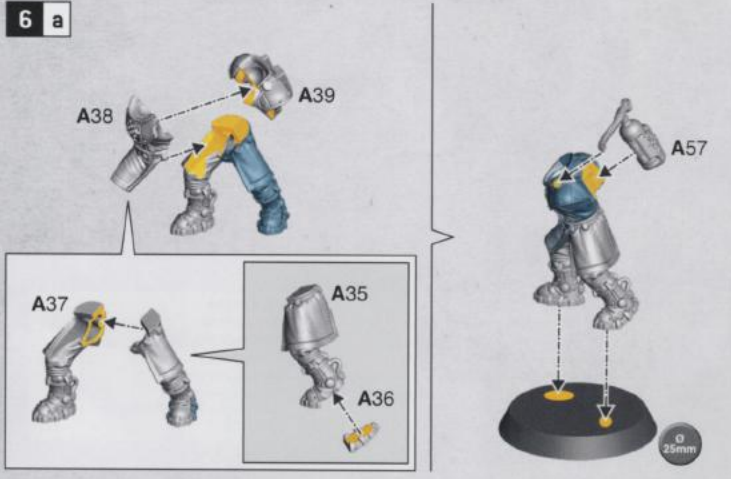
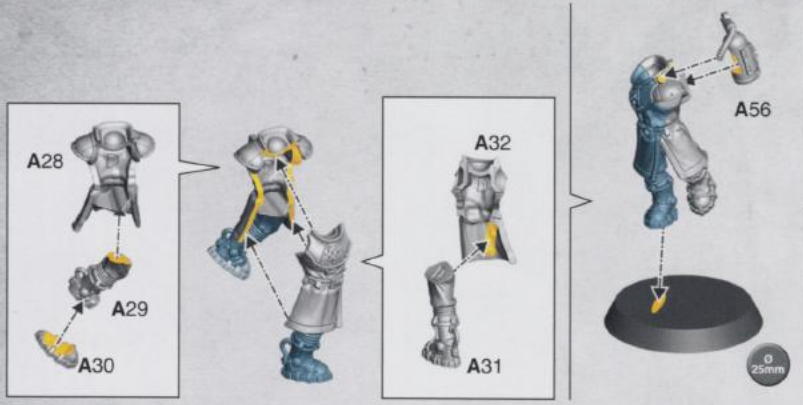

Navis Armsman
 Homme d'Armes Navis
 Infante de la Armada
 Navis-Flottensoldat
 Uomo d'Arme del Navis
 Навис Боец
 ネイヴィス・アームズマン
 海軍船兵

Navis Grenadier
 Grenadier Navis
 Granadero de la Armada
 Navis-Grenadier
 Granatiere Navis
 Навис Гранадёр
 ネイヴィス・グレネーティア
 海軍弾兵

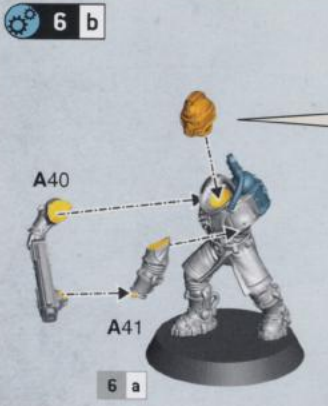

- A58 A86 A87
- A88 A89 A90
- A91 A92 A93
- A94 A95

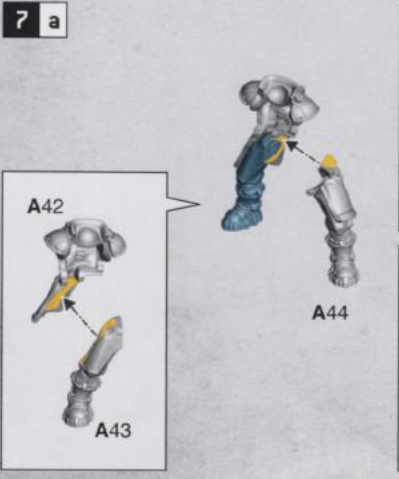
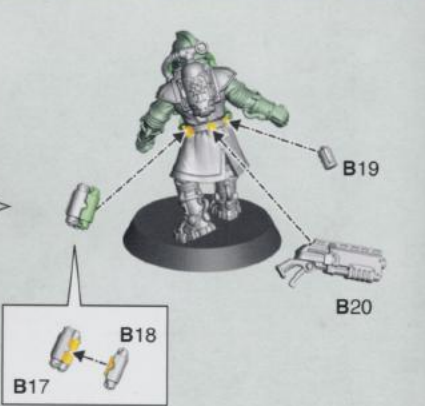

Navis Armsman
 Homme d'Armes Navis
 Infante de la Armada
 Navis-Flottensoldat
 Uomo d'Arme del Navis
 Навис Боец
 ネイヴィス・アームズマン
 海軍船兵

Navis Void-jammer
 Astrobrouilleur Navis
 Interferidor de la Armada
 Navis-Raum-Störer
 Disturbatore Vacuum del Navis
 Навис Пустотный Глушитель
 ネイヴィス・ヴォイドジャマー
 海軍干渉員

7 b

A46 A47

7 a

A58	A86	A87
A88	A89	A90
A91	A92	A93
A94	A95	

7 c

B33 B32 B35 B34 B36

7 a

7 d

Navis Gheistskull
Spectrocrâne Navis
Espectrocráneo de la Armada
Navis-Geisterschädel
Spettrotreschio del Navis
Навис Гейст-череп
ネイヴィス・ガイストスカル
海军幽魂颅骨

B37 B38

Ø 25mm



8 a

A48 A49 A50 A51 A52

Ø 25mm

8 b

8 c

Navis Armsman
Homme d'Armes Navis
Infante de la Armada
Navis-Flottensoldat
Uomo d'Arme del Navis
Навис Боец
ネイヴィス・アームズマン
海军船兵

Navis Hatchcutter
Coupe-trappe Navis
Cortahierros de la Armada
Navis-Schottschneider
Sfondaportelli del Navis
Навис Мясник
ネイヴィス・ハッチカッター
海军破船手

8 b

A58	A86	A87	A88	A89	A90
A91	A92	A93	A94	A95	

A53 A54 A57

8 a

8 c

B25 B24 B23 B27 B26 B22



1-8

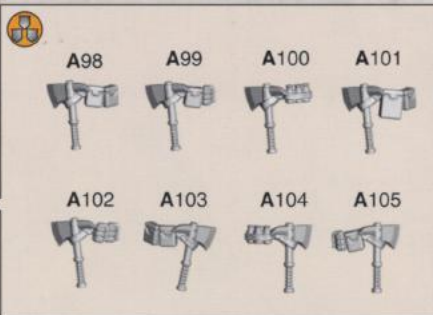

10 Navis Endurant | Hoplite Navis | Defensor de la Armada | Navis-Schildträger | Tenax del Navis | Навис Несгибаемый | ネイヴィス・エンデュラント | 海军盾手

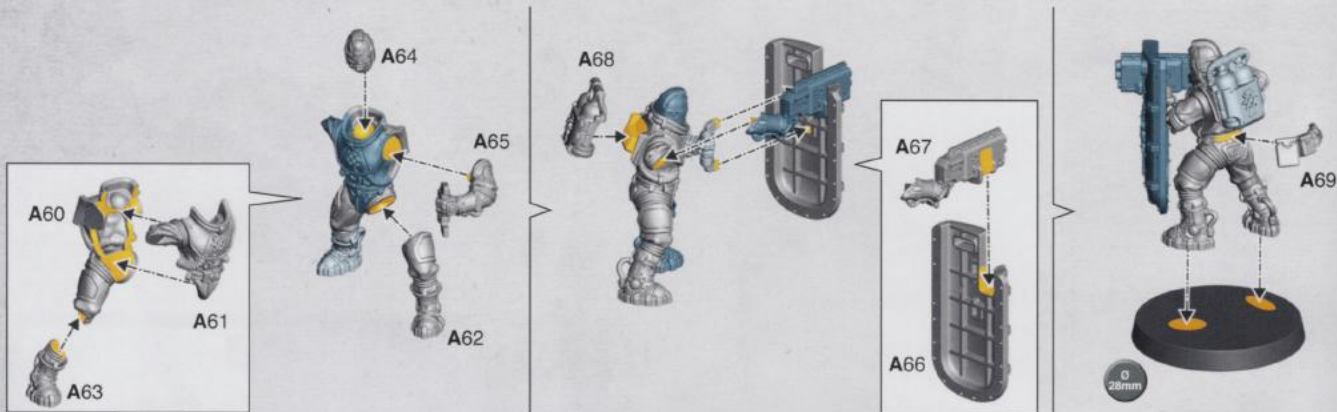

11 a

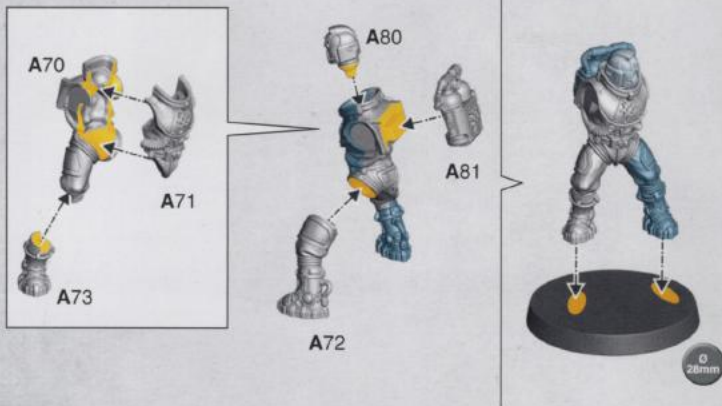

11 b



Navis Gunner
Mitrailleur Navis
Tirador de la Armada
Navis-Schütze
Artigliere Navis
Навис Стрелок
ネイヴィス・ガンナー
海军炮手

11 c



Navis Gunner
Mitrailleur Navis
Tirador de la Armada
Navis-Schütze
Artigliere Navis
Навис Стрелок
ネイヴィス・ガンナー
海军炮手

11 b

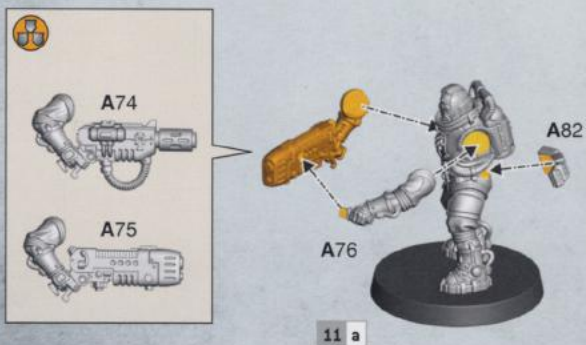

11 c

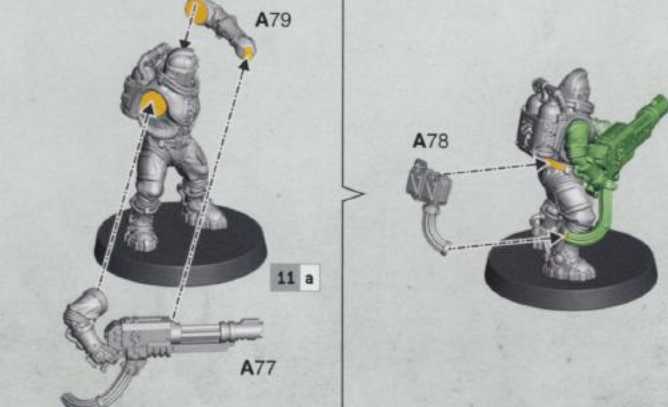

12

Kroot Kill-broker
 Courtier de Chasse Kroot
 Negociamueres Kroot
 Kroot-Todeshändler
 Kroot Mediatore
 Круут Агент Смерти
 クルート・キルブローカー
 克鲁特杀手头领

Kroot Kill-broker
 Courtier de Chasse Kroot
 Negociamueres Kroot
 Kroot-Todeshändler
 Kroot Mediatore
 Круут Агент Смерти
 クルート・キルブローカー
 克鲁特杀手头领

C98

C102 C103

12 a

C95 C96 C97

C99 C100 C101

12 b

C121 C122

Ø 32mm

• Interchangeable Parts
• Austauschbare Teile
• 組み換え可能な部品
• Éléments Interchangeables
• Componenti intercambiabili
• 可互换零件
• Partes Intercambiables
• Взаимозаменяемые части

13

C104 C105 C106 C107
C108 C109 C110 C111 C112

C114 C113 C115 C116 C118 C117 C120 C119

14 a

C1 C2 C3 C4 C5

Ø 28mm

14 b

Kroot Warrior
 Guerrier Kroot
 Combattiente Kroot
 Kroot-Krieger
 Kroot Guerriero
 Круут Воин
 クルート・ウォリアー
 克鲁特战士

14 c

Kroot Long-sight
 Øil-perçant Kroot
 Largavista Kroot
 Kroot-Fernschütze
 Kroot Occhio-Lungo
 Круут Дальногляд
 クルート・ロングサイト
 火氏老兵探路者

14 b



14 c

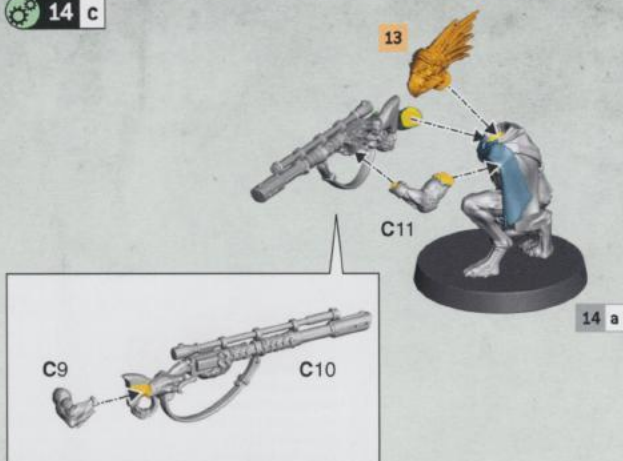

15

Kroot Warrior
Guerrier Kroot
Combatiente Kroot
Kroot-Krieger
Kroot Guerriero
Круут Воин
クルート・ウォリアー
克鲁特战士

15

Kroot Cold-blood
Sang-froid Kroot
Sangrefria Kroot
Kroot-Kaltblut
Kroot Sangue-Freddo
Круут Хладнокровный
クルート・コールドブラッド
克鲁特冷血佣兵

15 a

C12 C13 C14 C18

28mm

15 b

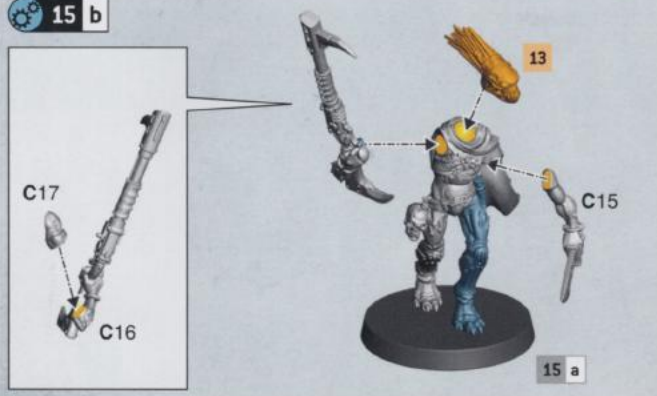

15 c

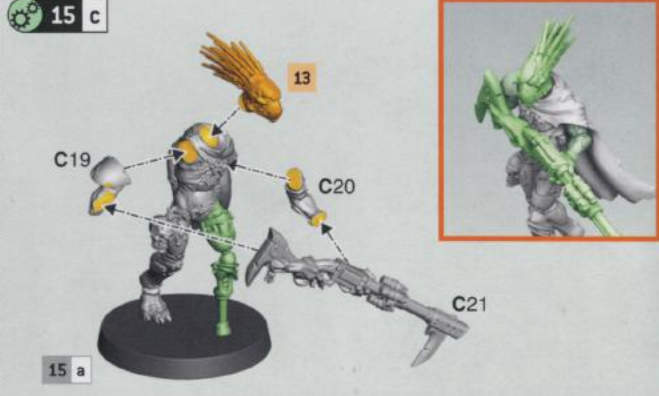

16 a

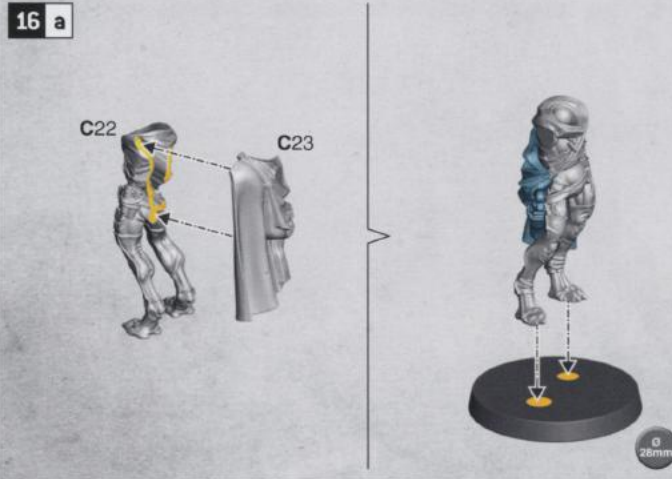

16 b

Kroot Warrior
Guerrier Kroot
Combatiente Kroot
Kroot-Krieger
Kroot Guerriero
Круут Воин
クルート・ウォリアー
克鲁特战士

16 c

Kroot Warrior
Guerrier Kroot
Combatiente Kroot
Kroot-Krieger
Kroot Guerriero
Круут Воин
クルート・ウォリアー
克鲁特战士

16 b



16 a

16 c



16 a

17 a

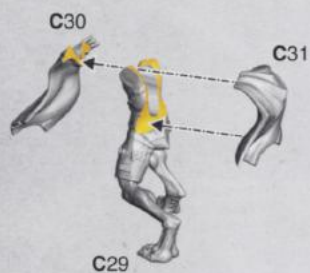

Ø 28mm

17 b



Kroot Warrior
 Guerrier Kroot
 Combatiente Kroot
 Kroot-Krieger
 Kroot Guerriero
 Круут Воин
 クルート・ウォリアー
 克鲁特战士

17 c



Kroot Warrior
 Guerrier Kroot
 Combatiente Kroot
 Kroot-Krieger
 Kroot Guerriero
 Круут Воин
 クルート・ウォリアー
 克鲁特战士

17 b



17 a

17 c



17 a

18 a

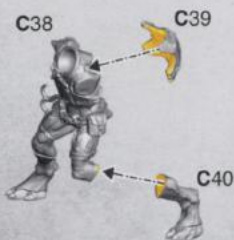

Ø 28mm

18 b



Kroot Warrior
 Guerrier Kroot
 Combatiente Kroot
 Kroot-Krieger
 Kroot Guerriero
 Круут Воин
 クルート・ウォリアー
 克鲁特战士

18 c



Kroot Cut-skin
 Dépeceur kroot
 Cortapieses Kroot
 Kroot-Hautschneider
 Kroot Squarcia-Pelle
 Круут Свежаватель
 クルート・カッツスキン
 克鲁特剥皮者

18 b

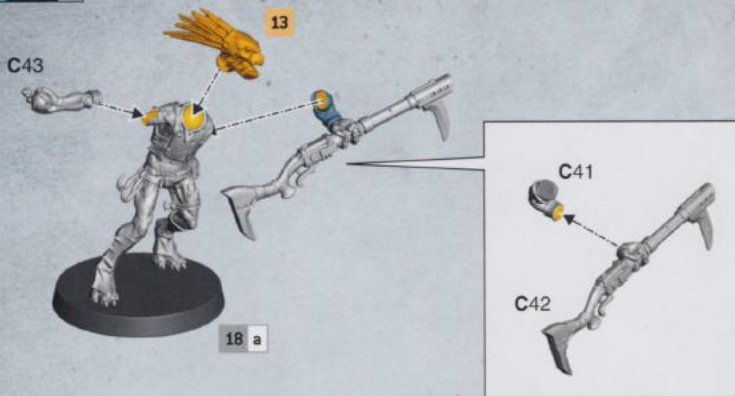

18 c



19 a

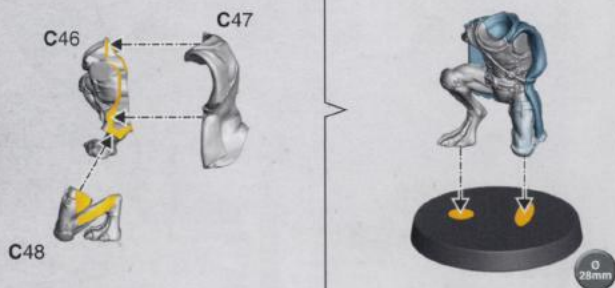

19 b



19 c



Kroot Stalker
Rabatteur Kroot
Acechador Kroot
Kroot-Pirscher
Kroot Inseguitore
Круут Ловчий
クルート・スーカー
克鲁特潜行者

Kroot Tracker
Pisteur Kroot
Rastreador Kroot
Kroot-Fährtenleser
Kroot Battipista
Круут Выслеживатель
クルート・トラッカー
克鲁特追踪者

19 b



19 c

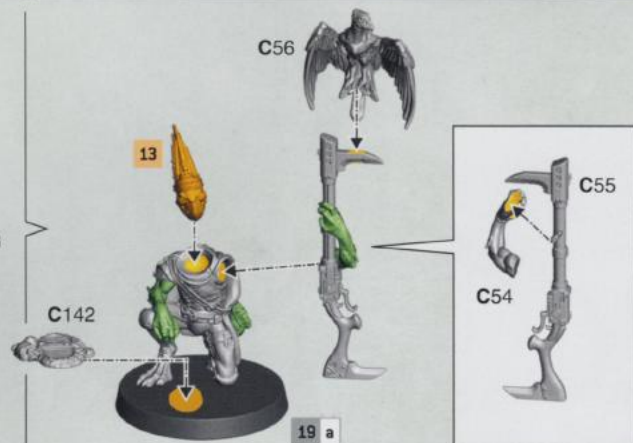

20 a

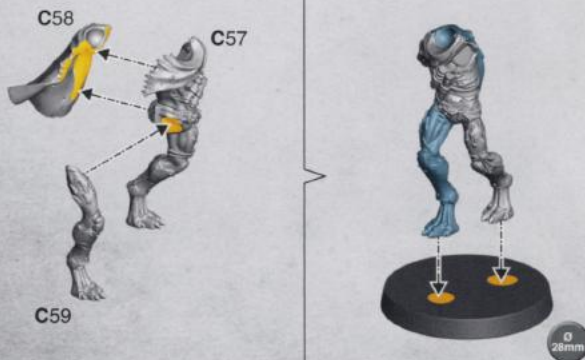

20 b



20 c



Kroot Warrior
Guerrier Kroot
Combatiente Kroot
Kroot-Krieger
Kroot Guerriero
Круут Воин
クルート・ウォリアー
克鲁特战士

Kroot Pistolier
Pistolier Kroot
Pistolero Kroot
Kroot-Pistolenschütze
Kroot Pistolero
Круут Пистольер
クルート・ビストラー
克鲁特枪手

20 b



20 c

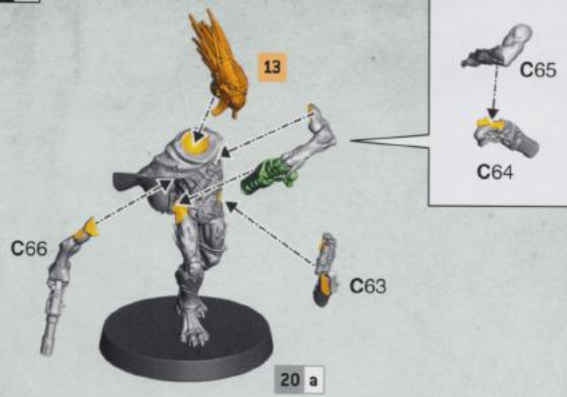

21 a



21 b-c



Kroot Warrior
Guerrier Kroot
Combatiante Kroot
Kroot-Krieger
Kroot Guerriero
Круут Воин
クルート・ウォリアー
克鲁特战士

21 d



Kroot Bow-hunter
Archer-chasseur Kroot
Cazaarquero Kroot
Kroot-Bogenjäger
Kroot Arciere
Круут Охотник-Лучник
クルート・ボウハンター
克鲁特弓箭手

21 b



21 c



21 d

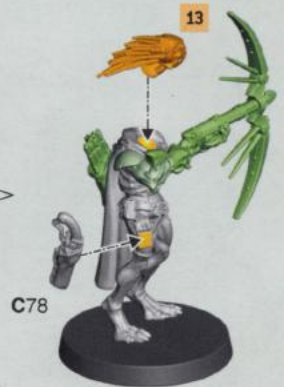

22 a

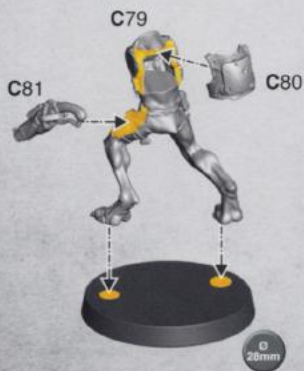

22 b



Kroot Warrior
Guerrier Kroot
Combatiante Kroot
Kroot-Krieger
Kroot Guerriero
Круут Воин
クルート・ウォリアー
克鲁特战士

22 c



Kroot Heavy Gunner
Mitrailleur Lourd Kroot
Tirador Pesado Kroot
Kroot-Schwerer-Schütze
Kroot Artigliere Pesante
Круут Тяжёлый Стрелок
クルート・ヘヴィガンナー
克鲁特重炮手

22 d



Kroot Heavy Gunner
Mitrailleur Lourd Kroot
Tirador Pesado Kroot
Kroot-Schwerer-Schütze
Kroot Artigliere Pesante
Круут Тяжёлый Стрелок
クルート・ヘヴィガンナー
克鲁特重炮手

22 b



22 a

22 c

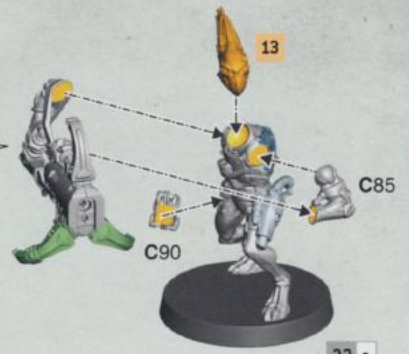
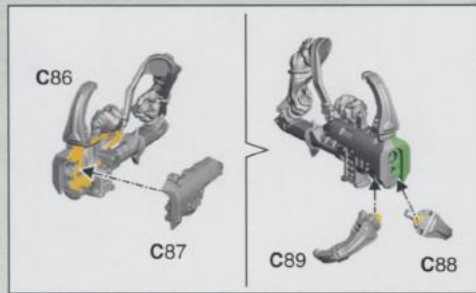

22 a

22 d

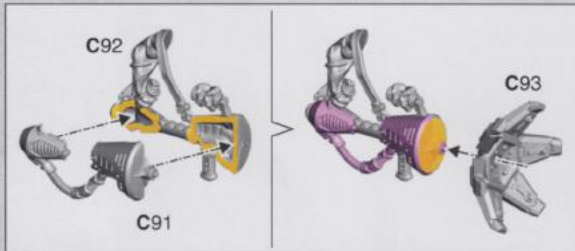

22 a



23



12 - 22

23



24

Kroot Hound
Chien Kroot
Mastín de Guerra Kroot
Kroot-Hund
Kroot Segugio
Круут Гончий
クルートハウンド
克鲁特猎犬

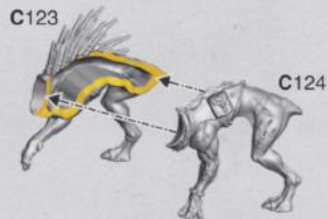

25

Kroot Hound
Chien Kroot
Mastín de Guerra Kroot
Kroot-Hund
Kroot Segugio
Круут Гончий
クルートハウンド
克鲁特猎犬

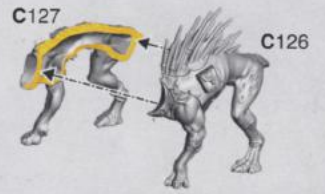

Ø 28mm

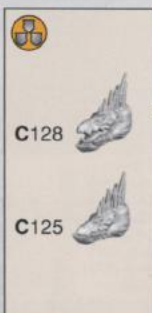

Ø 28mm

26 x2

Short Wall with Hatchway and Pillars
 Mur Court avec Écoutille et Piliers
 Muro corto con escotilla y pilares
 Kurze Wand mit Schott und Säulen
 Muro corto con boccaporto e colonne
 Короткая стена с люком и опорами
 短壁 (ハッチ、柱付き)
 有支柱和舱门过道的短墙壁

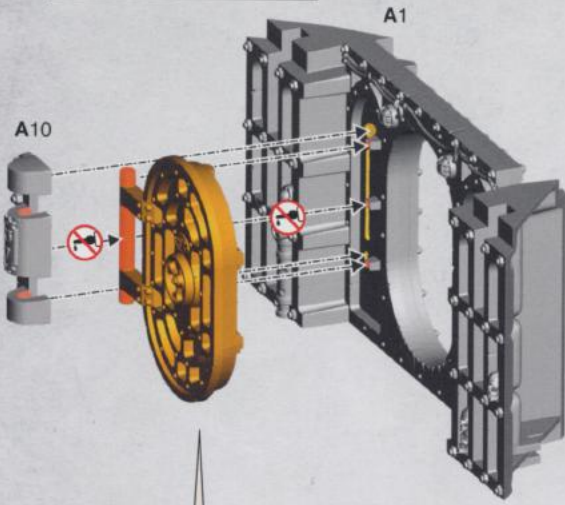

27 x2

Short Wall with Hatchway and Pillars
 Mur Court avec Écoutille et Piliers
 Muro corto con escotilla y pilares
 Kurze Wand mit Schott und Säulen
 Muro corto con boccaporto e colonne
 Короткая стена с люком и опорами
 短壁 (ハッチ、柱付き)
 有支柱和舱门过道的短墙壁

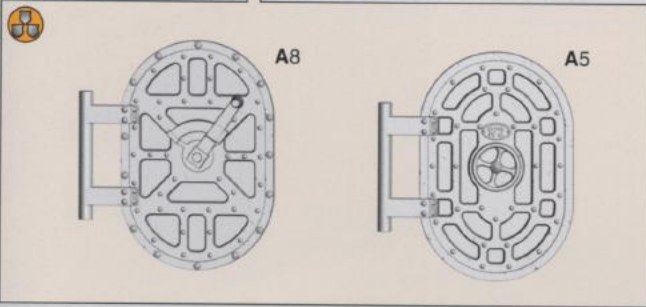
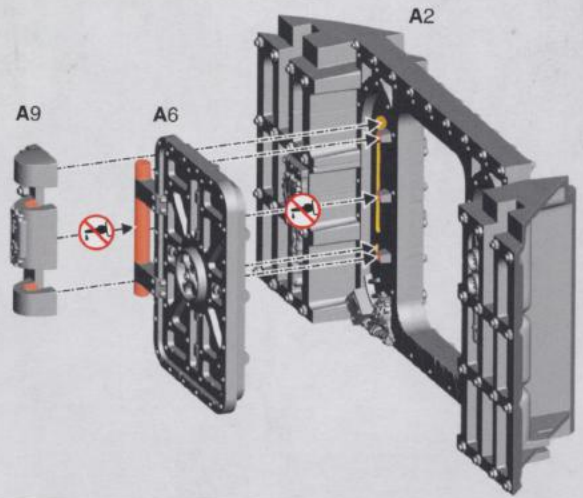

28 x2

Short Wall with Hatchway
 Mur Court avec Écoutille
 Muro corto con escotilla
 Kurze Wand mit Schott
 Muro corto con boccaporto
 Короткая стена с люком
 短壁 (ハッチ付き)
 有舱门过道的短墙壁

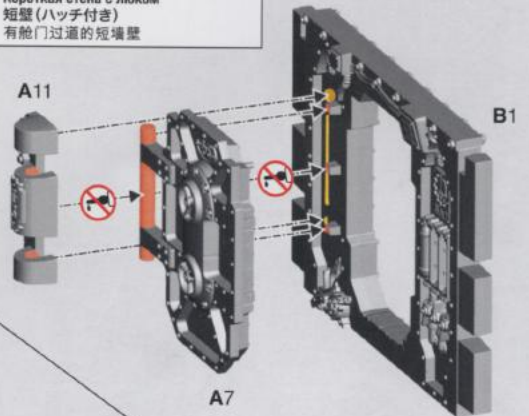

29 x2

Long Wall with Hatchway and Pillars
 Mur Long avec Écoutille et Piliers
 Muro largo con escotilla y pilares
 Lange Wand mit Schott und Säulen
 Muro lungo con boccaporto e colonne
 Длинная стена с люком и опорами
 长壁 (ハッチ、柱付き)
 有支柱和舱门过道的长墙壁

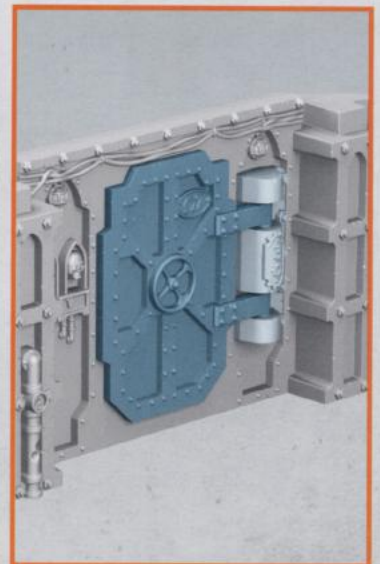
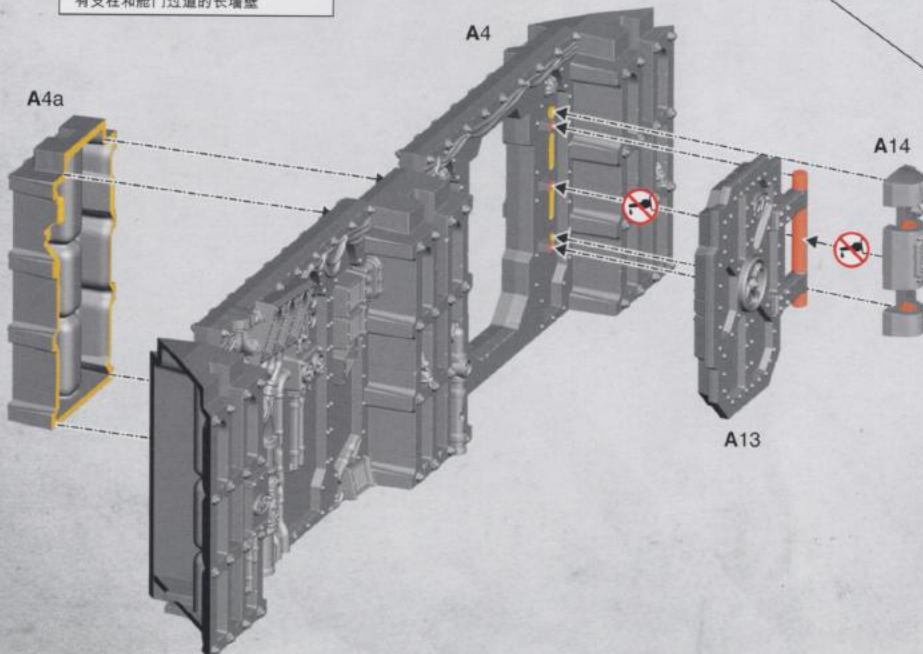

30 x2

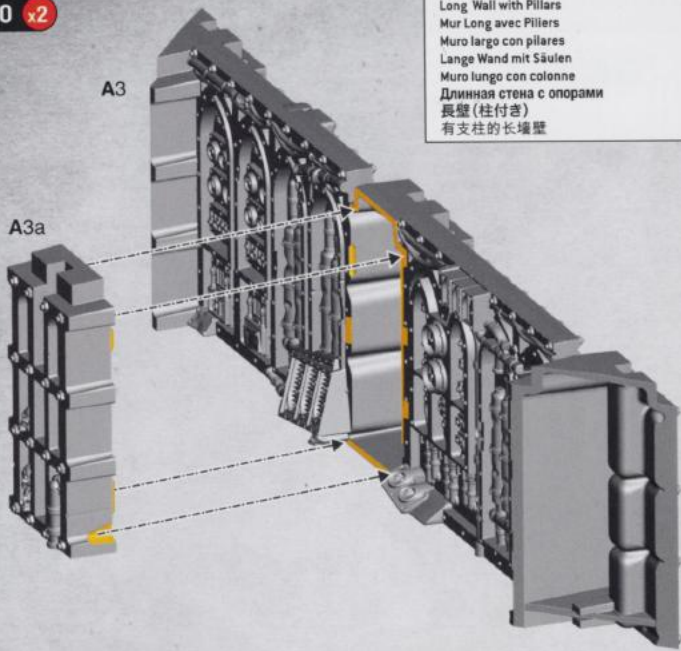

Long Wall with Pillars
 Mur Long avec Piliers
 Muro largo con pilares
 Lange Wand mit Säulen
 Muro lungo con colonne
 Длинная стена с опорами
 長壁 (柱付き)
 有支柱的长墙壁

31 x2

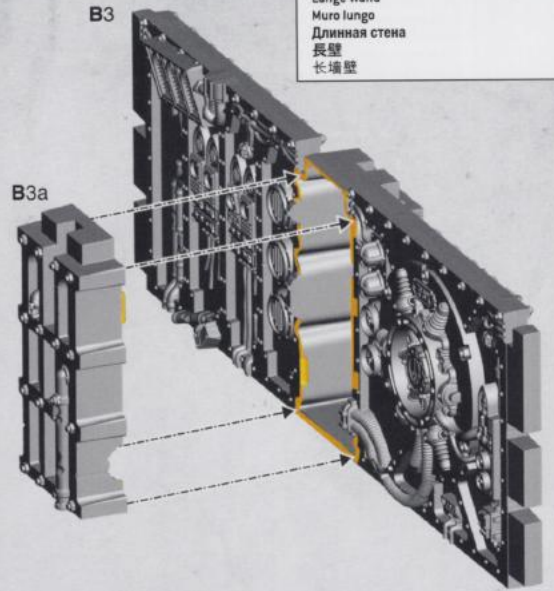

Long Wall
 Mur Long
 Muro largo
 Lange Wand
 Muro lungo
 Длинная стена
 長壁
 长墙壁

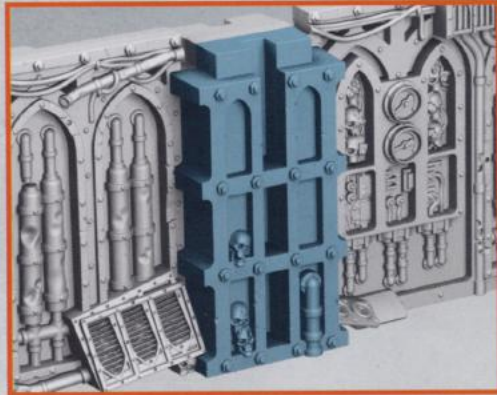

32 x2

Short Wall
 Mur Court
 Muro corto
 Kurze Wand
 Muro corto
 Короткая стена
 短壁
 短墙壁

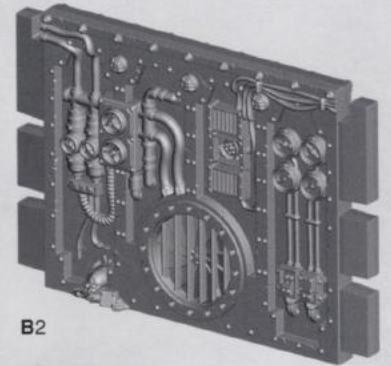

33 x2

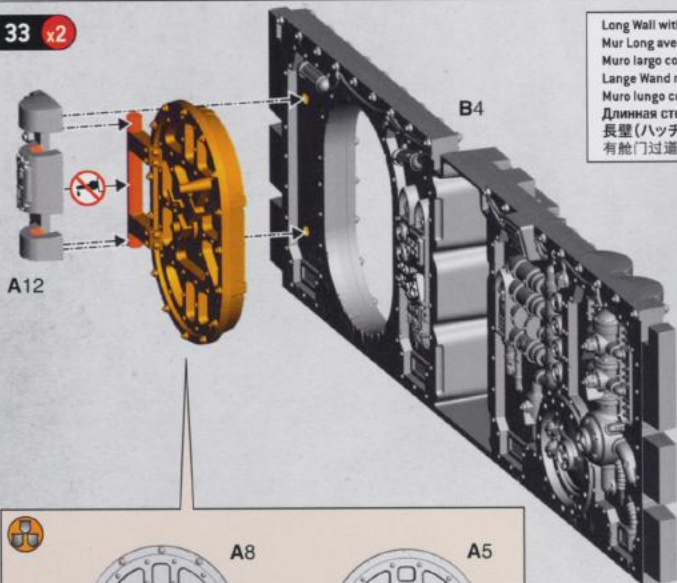

Long Wall with Hatchway
 Mur Long avec Écoutille
 Muro largo con escotilla
 Lange Wand mit Schott
 Muro lungo con boccaporto
 Длинная стена с люком
 長壁 (ハッチ付き)
 有舱门过道的长墙壁

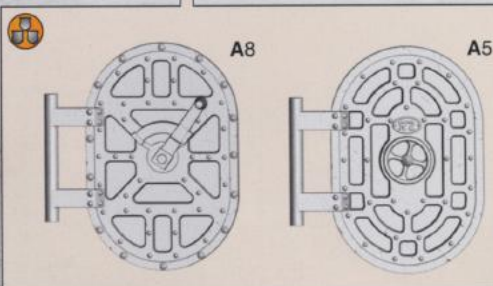
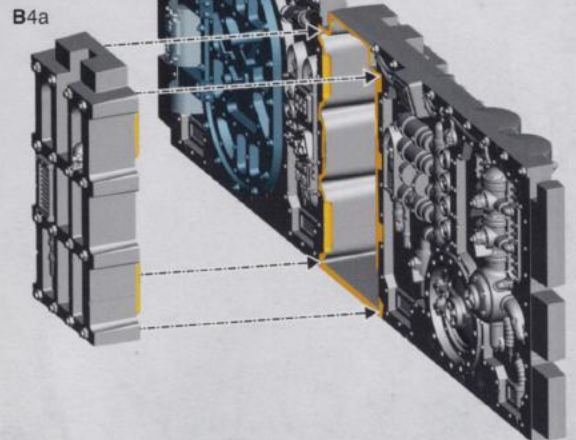

34 x16

Pillar
Pilier
Pilar
Säule
Colonna
Опора
柱
支柱

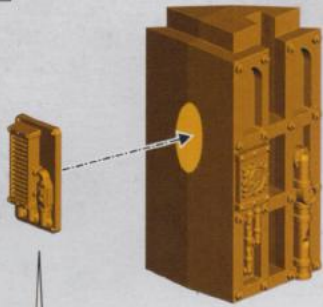

C13
X2



C14
X2



C15
X2

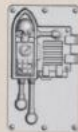

C16
X2



C17
X2



C18
X2



C19
X2



C20
X2

35 x2

Wall End
Extrémité de Mur
Borde de Muro
Wandende
Estremità del muro
Край стены
壁の端
墙壁末端

C4



36 x2

Overhead Pipe
Conduite Suspendue
Tuberia Elevada
Deckenleitung
Tubo sopraelevato
Подвесная труба
上部導管
架空管道

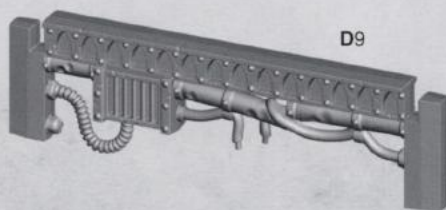

D9



L

C9
X2

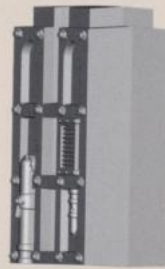

C10
X2

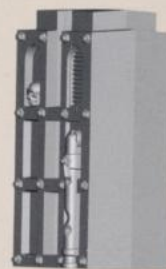

C11
X2



C12
X2

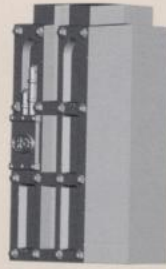

R

C5
X2



C6
X2



C7
X2

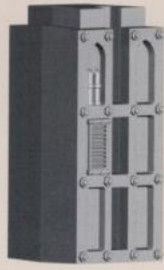

C8
X2



37 x2

Broken Pipe
Conduite Rompue
Tuberia Rota
Geborstene Leitung
Tubo spezzato
Повреждённая труба
壊れし導管
损坏管道

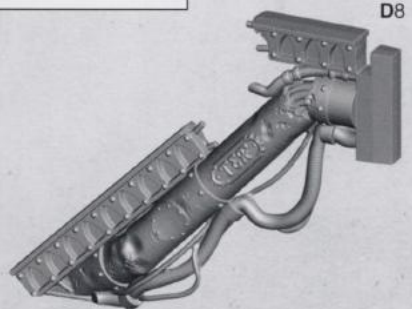

D8

38 x2

Power Panel
 Panneau d'Alimentation
 Panel de energia
 Energiestation
 Pannello energetico
 Силовая панель
 電源盤
 电源面板



D1

39 x2

Control Panel
 Panneau de Contrôle
 Panel de control
 Kontrollstation
 Pannello di controllo
 Панель управления
 管制盤
 控制面板

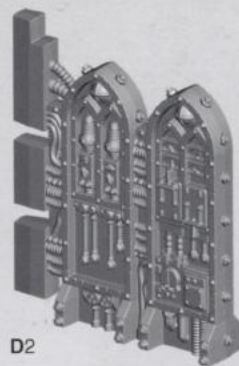

D2

40 x2

Tanks
 Cuves
 Tanques
 Tanks
 Serbatoi
 Баллоны
 タンク
 儲存罐

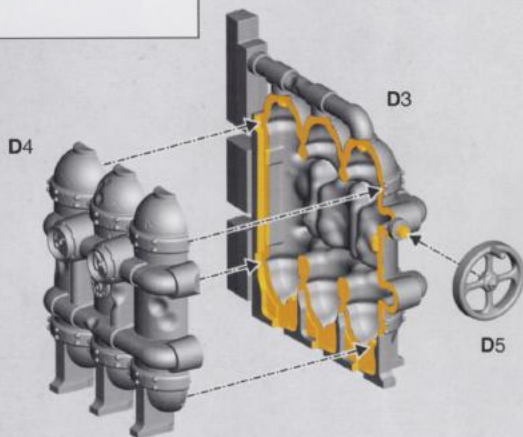

D3

D4

D5

41 x2

Pipes
 Conduites
 Tuberías
 Leitungen
 Tubi
 Трубы
 配管
 管道

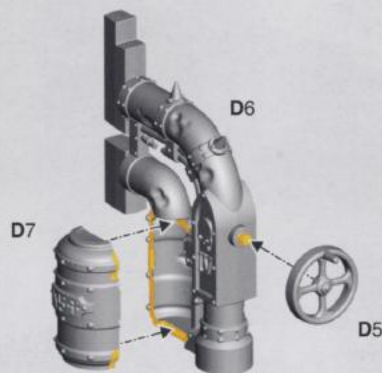

D6

D7

D5

42 x2

Dynamo
 Dynamo
 Dinamo
 Generator
 Dinamo
 Динамо-машина
 發電機
 发电机

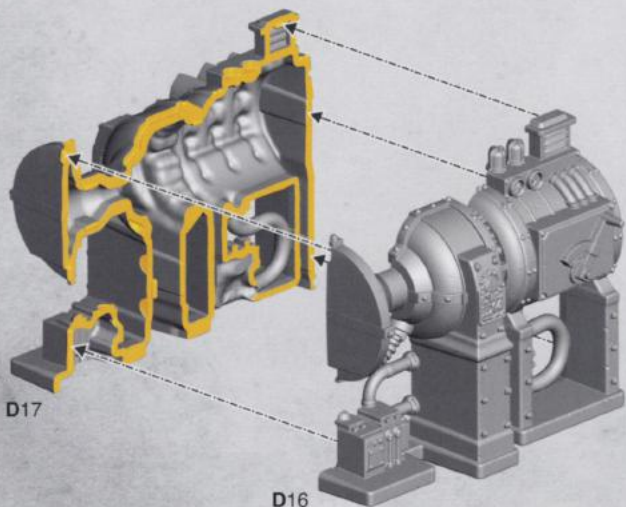

D17

D16

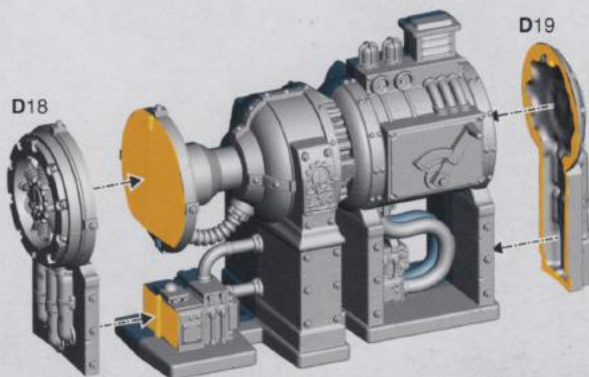

D18

D19

43 x2

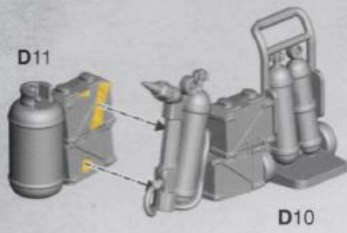

44 x2

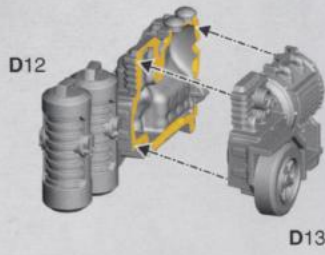

45 x4

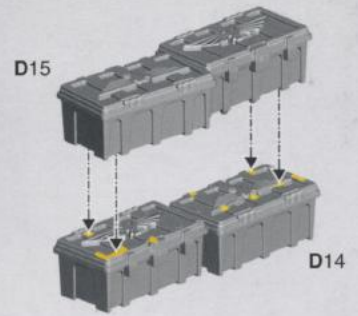

- Example Assemblies
- Exemples d'Assemblages
- Ejemplos de montaje

- Beispiele
- Esempi di assemblaggio
- ОБРАЗЦЫ СБОРКИ

- 組み立ての例
- 装束示例

! 46 a

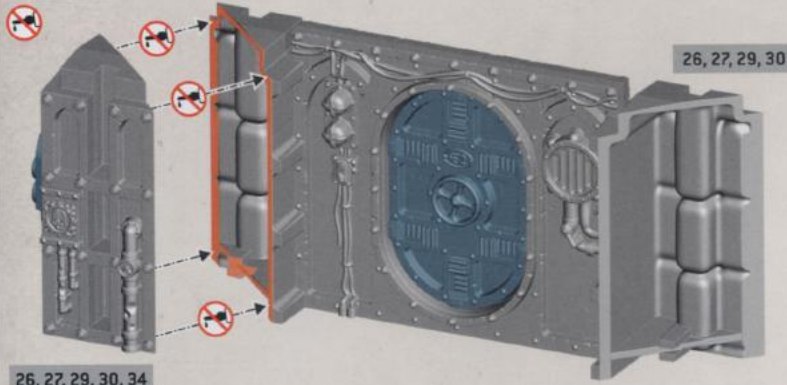

26, 27, 29, 30, 34

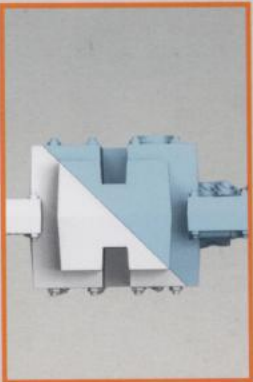
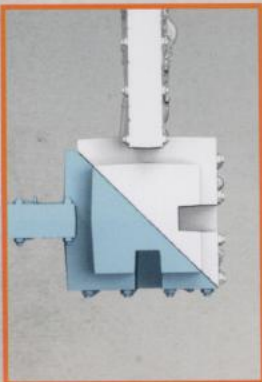
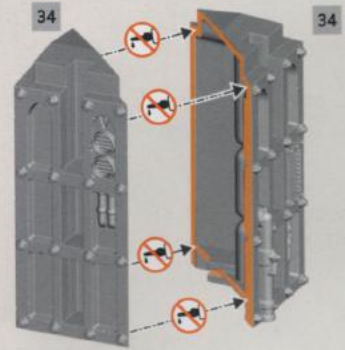

! 46 b

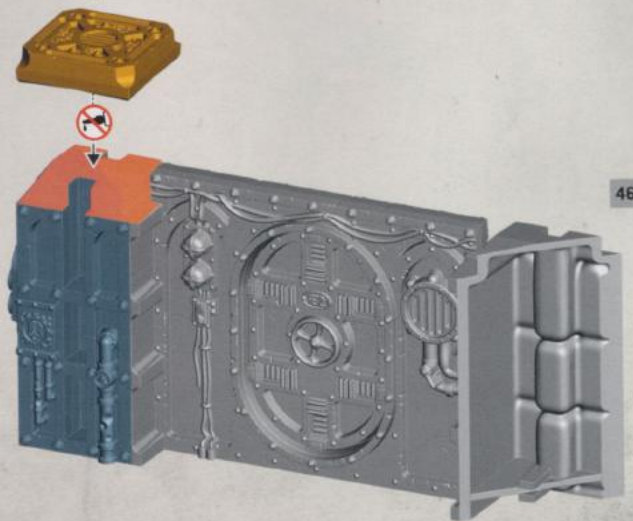
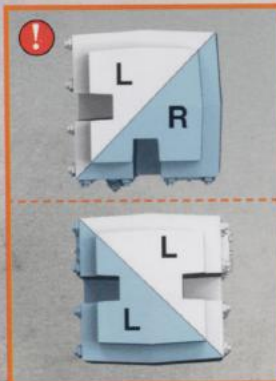
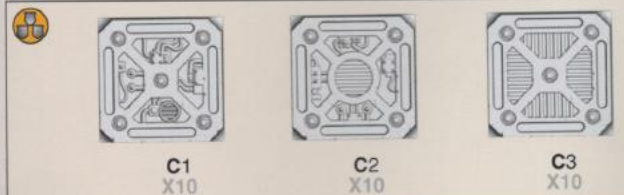

46 a

! 46 c

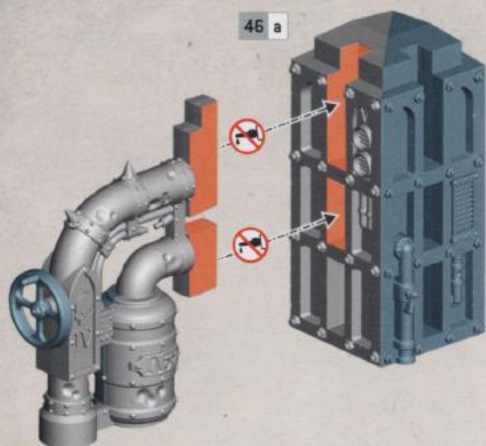

36 - 42



C1 X10

C2 X10

C3 X10

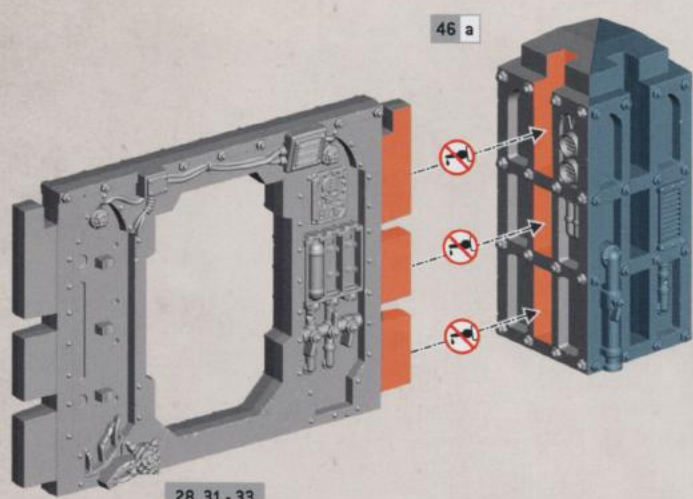

28, 31 - 33



! 47

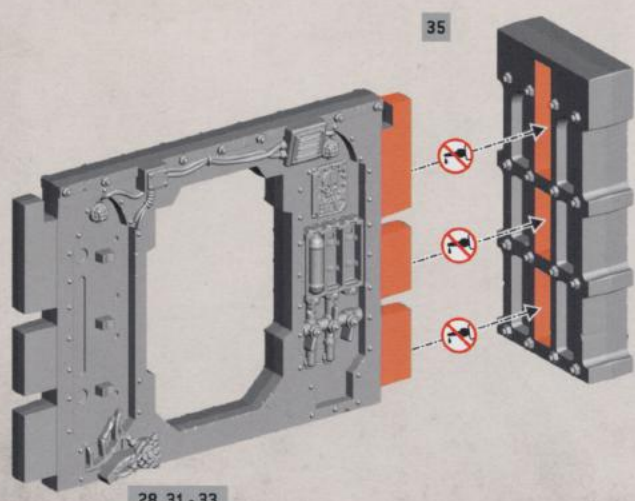

28, 31 - 33

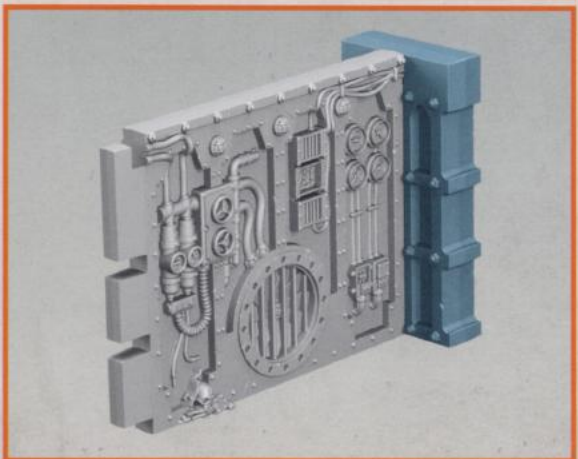

WARHAMMER.COM

Games Workshop Limited, Willow Road, Nottingham, NG7 2WS, UK
© Copyright Games Workshop Limited 2022.

