



Free Downloads of Build Instructions,
Assembly Booklets & How To Guides

BuildInstructions.com

WARHAMMER
40,000

KILL TEAM SHADOWVAULTS



SKIRMISH COMBAT IN THE 41ST MILLENNIUM

READ THIS FIRST | À LIRE EN PRIORITÉ | BITTE BEACHT E | LEE ESTO PRIMERO | LEGGI PRIMA QUESTO | В ПЕРВУЮ ОЧЕРЕДЬ ПРОЧИТАЙТЕ ЭТО
最初にお読みください。| 请优先阅读

ENG BEFORE ASSEMBLING YOUR MINIATURES, PLEASE READ THROUGH THE INSTRUCTIONS IN THIS BOOKLET CAREFULLY. A pair of plastic cutters is required to remove the plastic components in this kit from their frame. We advise using a mouldline scraping tool to clean up the parts. To assemble your model you will need plastic glue. Games Workshop sells Citadel Fine Detail Cutters, Citadel Mouldline Remover and Citadel Plastic Glue, but does not recommend these products for use by children under the age of 16 without adult supervision.

FRE AVANT D'ASSEMBLER VOS FIGURINES, VEUILLEZ LIRE ATTENTIVEMENT LES INSTRUCTIONS DE CE LIVRET. Une pince coupante est requise pour détacher chaque élément de sa grappe. Nous vous recommandons l'utilisation d'un grattoir pour ébarber les éléments. Pour l'assemblage, vous aurez également besoin de colle plastique. Games Workshop commercialise les Pinces de Précision Citadel, l'Ébarboir Citadel et la Colle Plastique Citadel, mais n'en recommande pas l'utilisation pour des enfants de moins de 16 ans sans la supervision d'un adulte.

SPA POR FAVOR, LEE CUIDADOSAMENTE ESTE LIBRETO DE INSTRUCCIONES ANTES DE EMPEZAR A MONTAR LAS MINIATURAS. Te harán falta unas tenazas para plástico a fin de separar las piezas de la matriz. También aconsejamos una herramienta para rebabas a fin de limpiar cada pieza. Para montar la miniatura necesitarás pegamento para plástico. Games Workshop vende Tenazas Citadel. Herramientas para rebabas Citadel y Pegamento para plástico Citadel, pero no recomienda estos productos a menores de 16 años sin la supervisión de un adulto.

GER VOR DEM ZUSAMMENBAU DER MINIATUREN BITTE DIE ANWEISUNGEN IN DIESER ANLEITUNG AUFMERKSAM DURCHLESEN. Du benötigst einen Kunststoffseitschneider, um die Kunststoffbauteile aus dem Gussrahmen herauszutrennen, und Kunststoffkleber, um die Miniatur zusammenzubauen. Außerdem empfehlen wir, die Bauteile vorher mit einem Gussgratentferner zu säubern. Games Workshop bietet Präzisions-Kunststoffseitschneider von Citadel sowie Citadel-Kunststoffkleber an, empfiehlt aber, dass Kinder unter 16 Jahren diese nur unter Aufsicht eines Erwachsenen benutzen.

ITA PRIMA DI ASSEMBLARE LE TUE MINIATURE LEGGI ATTENTAMENTE TUTTE LE ISTRUZIONI DI QUESTO LIBRETTO. Sono necessarie un paio di tronchesine per plastica per staccare i componenti dai loro sprue. Consigliamo di usare un attrezzo apposito per pulire i componenti. Per assemblare il modello avrai bisogno di colla per plastica. Games Workshop vende Tronchesine di precisione Citadel. Attrezzo per ripulire Citadel e Colla per plastica Citadel, ma non consiglia questi prodotti ad un pubblico minore di 16 anni senza la supervisione di un adulto.

RUS Кусачки для пластика нужны для снятия пластиковых элементов набора с рамок. Для зачистки деталей рекомендуем использовать инструмент для удаления дефектов. Для сборки модели вам понадобится клей для пластика. Компания "Games Workshop" предоставляет кусачки "Citadel Fine Detail Cutters", инструмент для удаления дефектов "Citadel Mouldline Remover" и клей для пластика "Citadel Plastic Glue", но не рекомендует эти изделия к использованию детьми младше 16 лет без надзора взрослых.

日 本キット内のフレームからプラスチックパーツを切り離すためには、ニッパーが必要です。パーツのモールドを平らにするには、専用ツールの使用をお勧めいたします。本キットの組み立てには、プラ用接着剤が必要です。ゲームズワークショップはシタデル・ニッパー、プラ用接着剤、シタデル・モールドラインリムーバーを販売しておりますが、16歳以下の子供が大人の監督なしにこれらの道具を使用されることをお勧めしません。

中 文 你需要一把模型剪将塑料部件从板件上剪下来。我们建议使用分模线刮刀来处理零件。组装时你还需要用到模型胶水。你可以从 Games Workshop 处购买到 Citadel Fine Detail Cutter 模型剪、Citadel Mouldline Remover 分模线刮刀和 Citadel Plastic Glue 模型胶,但 16 岁以下儿童不得在没有成年人监护的情况下使用这些产品。

EXPLANATION OF SYMBOLS | EXPLICATION DES SYMBOLES | EXPLICACIÓN DE SÍMBOLOS | ERLÄUTERUNG DER SYMBOLE | LEGENDA DEI SIMBOLI
РАСШИФРОВКА СИМВОЛОВ | アイコン解説 | 符号说明

! • Special instruction - Please read
• Instructions spéciales - Lire attentivement
• Instrucción especial: Por favor, léela
• Besondere Anweisung - Bitte lesen
• Istruzioni speciali - Leggi attentamente
• Особая инструкция - просьба ознакомиться
• 特記事項 - 必ずお読みください
• 特殊说明 - 请详阅

⚙️ • Variant assembly
• Variante d'assemblage
• Variante de montage
• Bauvariante
• Assemblaggio alternativo
• Варианты сборки
• 組み立てバリエーション
• 多种组装方式

⚖️ • Use matching parts
• Utiliser les éléments correspondants
• Usa las piezas que correspondan
• Verwende die passenden Teile
• Usa le parti corrispondenti
• Последовательность сборки
• 適合するパーツを使用
• 使用匹配部件

🚫 • Do not glue the components
• Ne pas coller les éléments
• No pegar los componentes
• Bitte die Teile nicht kleben
• Non incollare i componenti
• Не склеивайте детали
• このパーツは接着不可
• 请勿粘接

≤2 • Build the number required, up to the limit shown
• Assembler le nombre requis, jusqu'à la limite indiquée
• Monta la cantidad requerida, hasta el límite mostrado
• Bau die benötigte Anzahl, bis zum angegebenen Limit
• Assembla il numero richiesto, fino al limite indicato
• Соберите нужное количество
• 示されている上限を超えないように、必要数を組み立てること
• 按要求数量组装直至上限

ⓧ • Repeat process
• Répéter l'étape
• Repetir pasos
• Vorgang wiederholen
• Ripeti il processo
• Повторите действие
• 同じ作業を繰り返すこと
• 重复步骤

👤 • Choice of parts
• Choix d'éléments
• Modelos de componentes
• Auswahl an Teilen
• Scelta di componenti
• Выбор деталей
• パーツの選択
• 选择部件

✅ • Stage complete
• Étape terminée
• Paso completado
• Schritt abgeschlossen
• Fase completa
• Этап завершен
• このステージの完成
• 完成

A



Ø 28mm x10



B



Ø 50mm x1

C

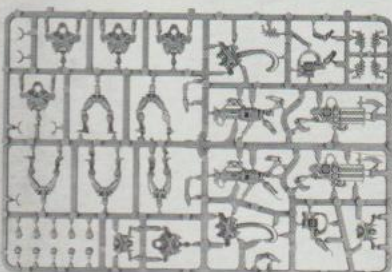

Ø 32mm x5

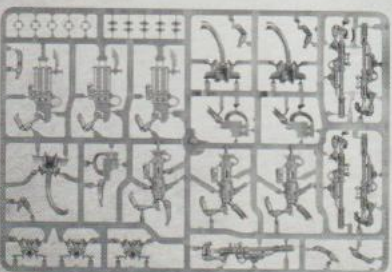

Ø 25mm x2

D



x2

**KILLZONE:
GALLOWDARK**

KILLZONE: GALLOWDARK | ZONA DE ANIQUILACIÓN: HORCASOMBRÍA
 KILLZONE: GALGENSCHWARZE | KILLZONE: PATIBOLO NERO
 БОЕВОЙ СЕКТОР: КРОМЕШНЫЙ МРАК | キルゾーン:ギャロウダーク
 杀戮区: 绞架暗渊

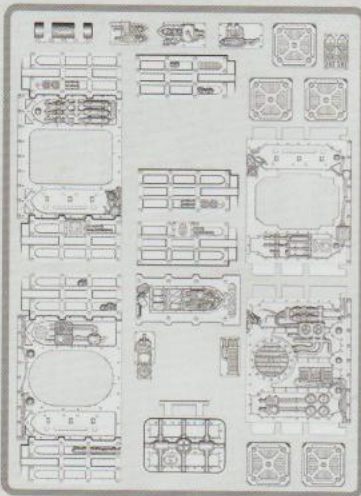
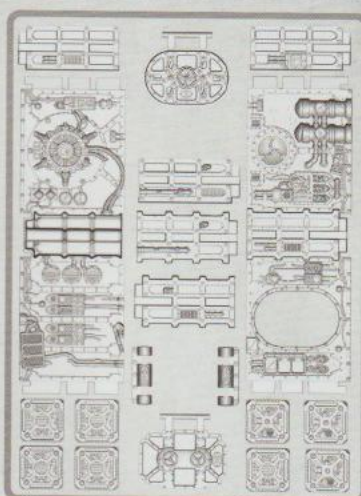
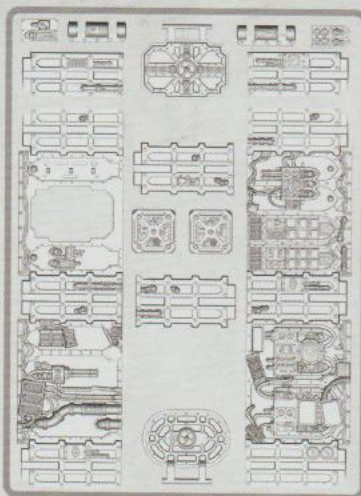

x1

**KILLZONE UPGRADE:
SHADOWVAULTS**

EXTENSION DE KILLZONE: CALES OBSCURES
 MEJORA DE ZONA DE ANIQUILACIÓN: BÓVEDAS DE SOMBRA
 KILLZONE-ERGÄNZUNG: SCHATTENKAMMERN
 DOTAZIONI DELLA KILLZONE: CRIPTE NERE
 ДОПОЛНЕНИЕ К БОЕВОЙ ЗОНЕ: СУМРАЧНЫЕ ТРУМЫ
 キルゾーン・アップグレード: シャドウヴォールト
 杀戮区改件: 暗影宝库

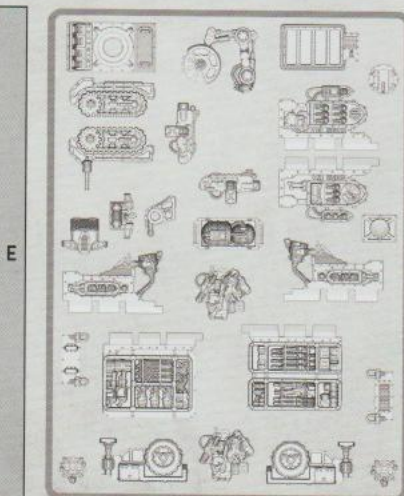

13 a

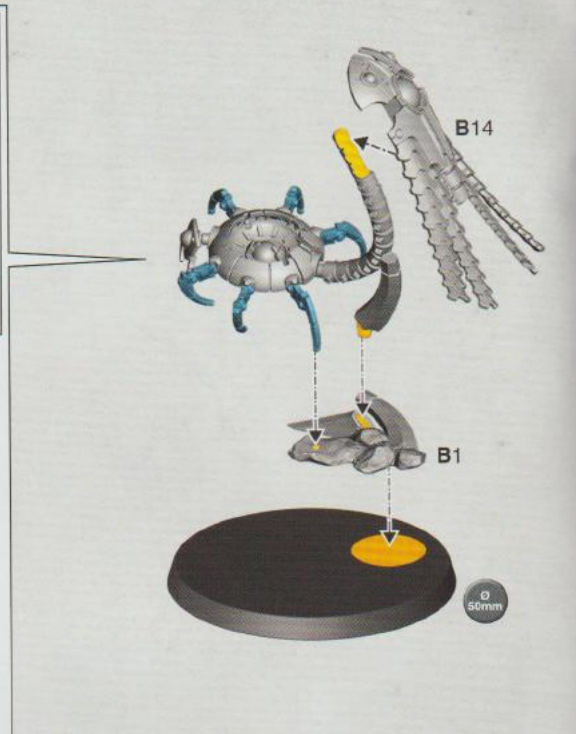
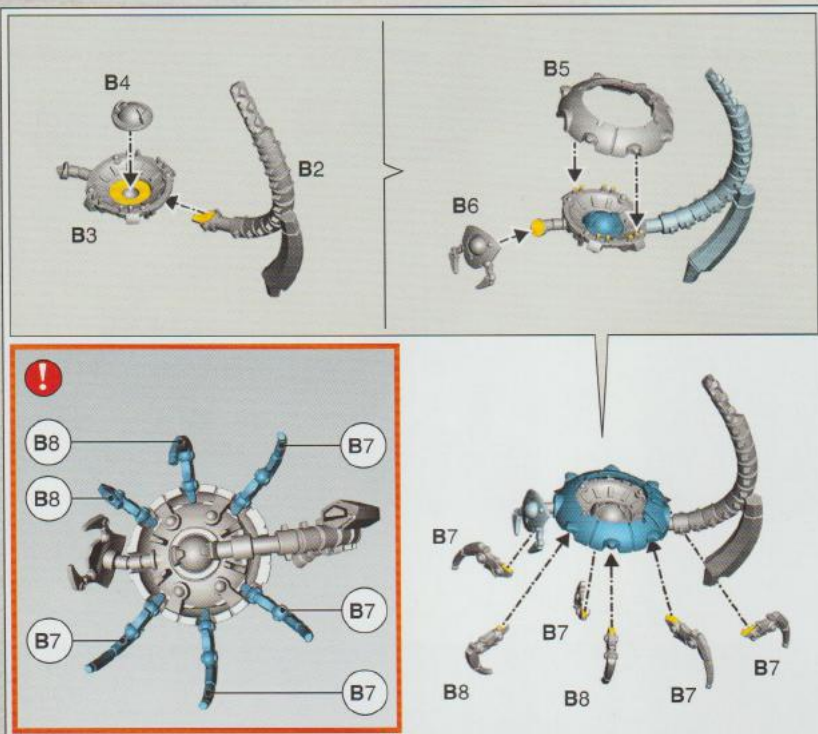

13 b

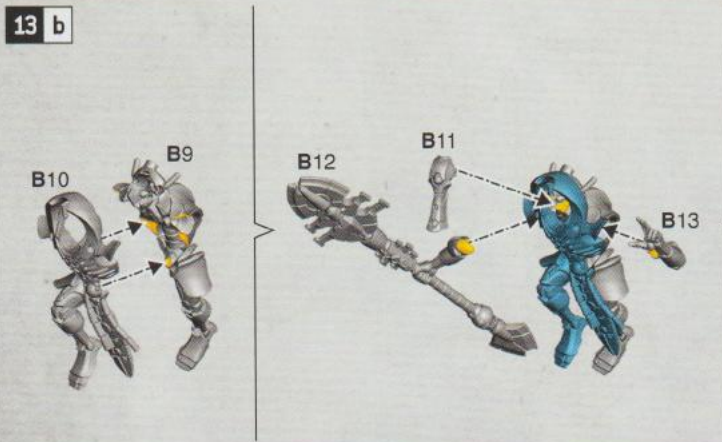

ENG More painting guides can be found on citadelcolour.com
 FRE D'autres guides de peinture sont disponibles citadelcolour.com
 SPA Encontrarás más guías de pintura en citadelcolour.com
 GER Weitere Bemalanleitung auf citadelcolour.com
 ITA Puoi trovare altre guide alla pittura su citadelcolour.com
 RUS Дополнительные инструкции по покраске на сайте citadelcolour.com
 日本語 citadelcolour.com には他にも様々なペイントガイドが掲載されている
 中文 更多涂装指南请至 citadelcolour.com



14 a

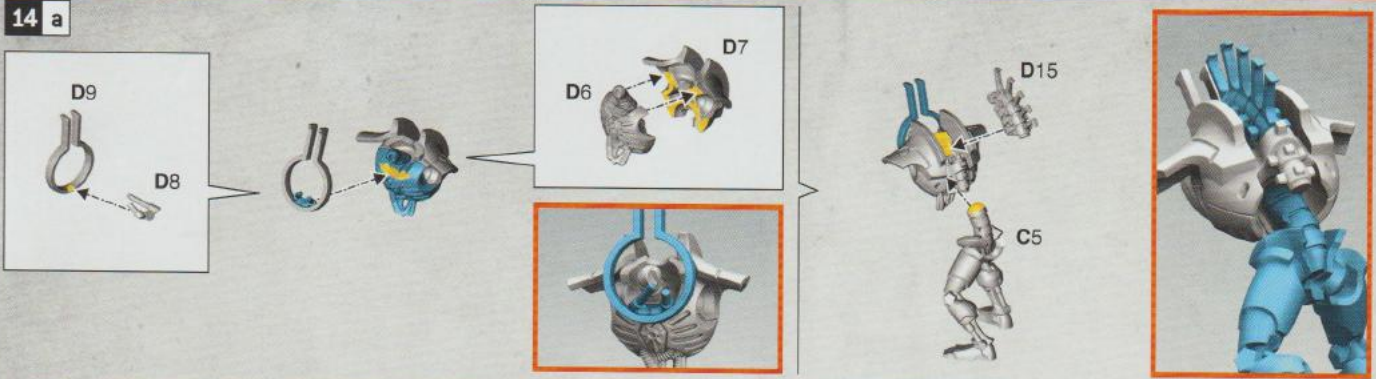

14 b

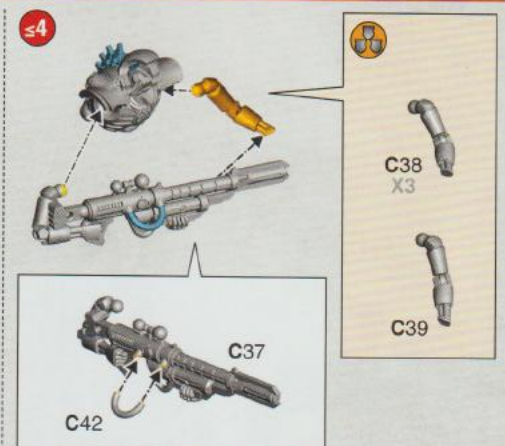
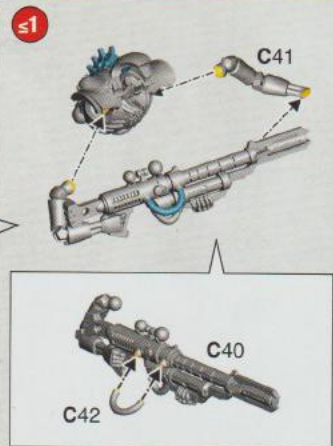
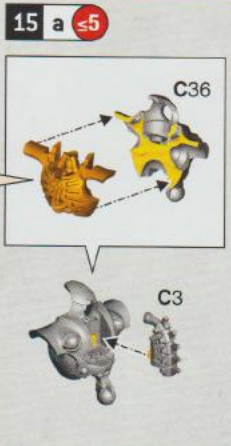

15 b ≤5

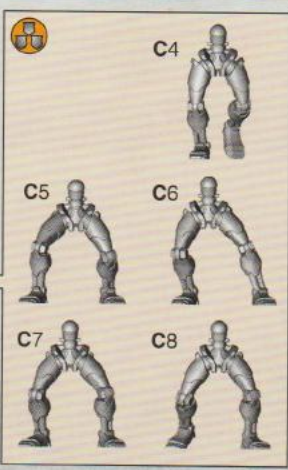

16 a

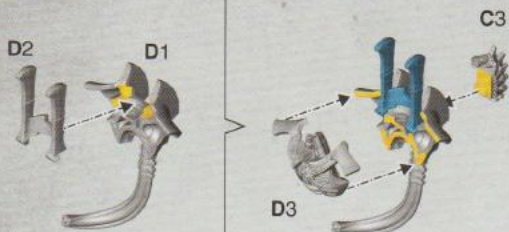

16 b



16 c



16 b

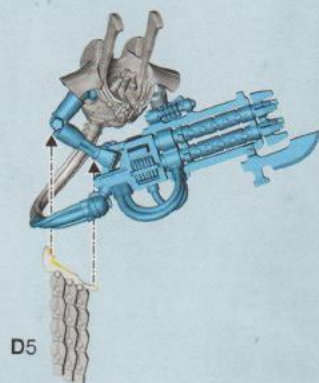
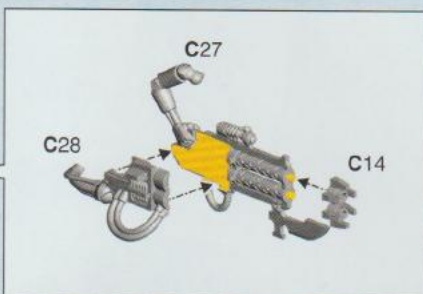
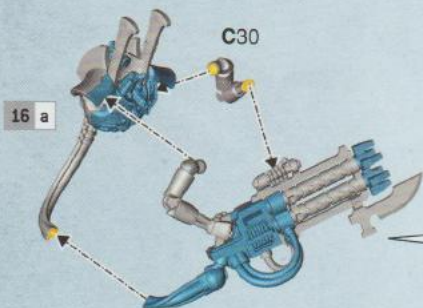

16 c

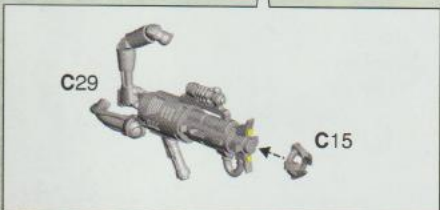
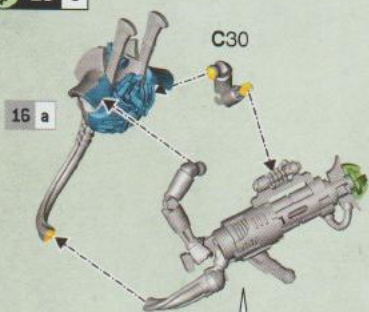

16 d

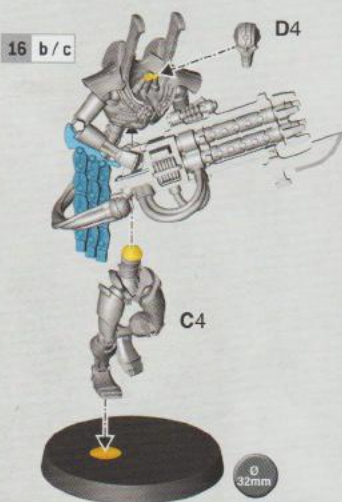

17

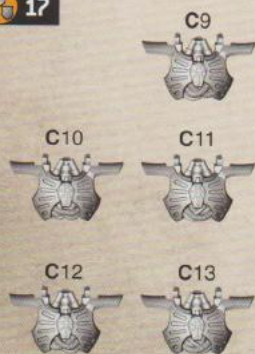

18 ≤5



18 a

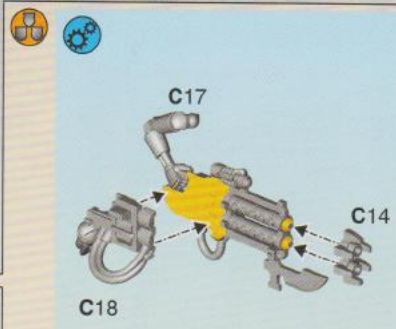
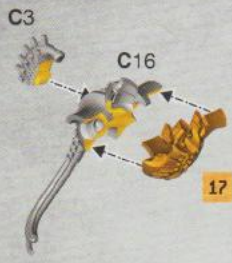

18 b

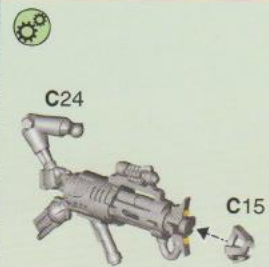
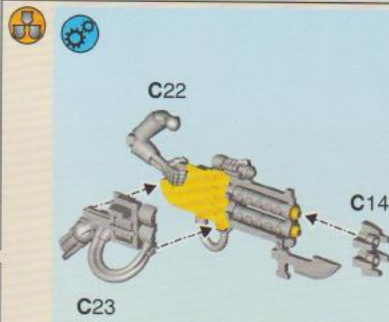
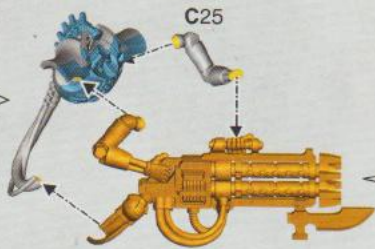
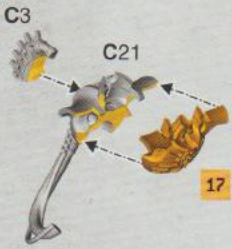

18 c

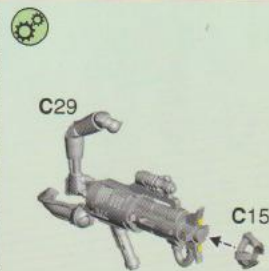
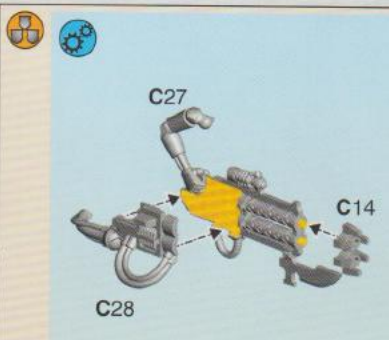
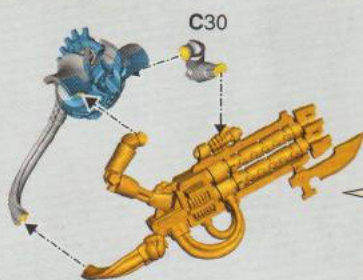
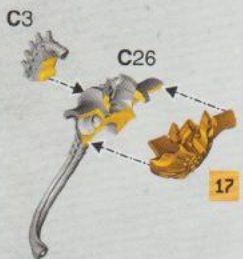

18 d

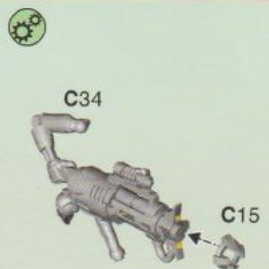
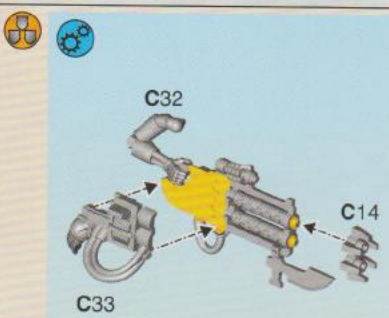
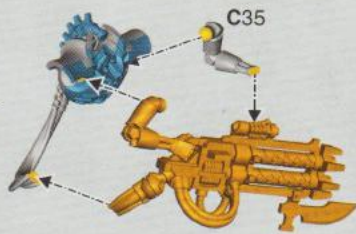
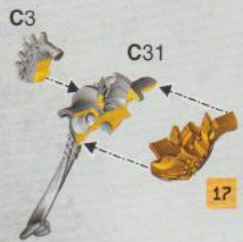

18 e

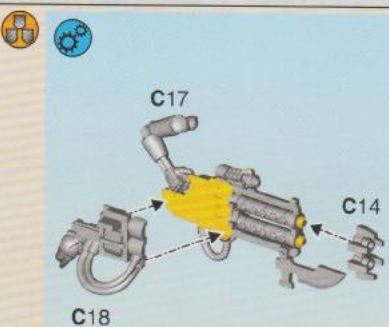
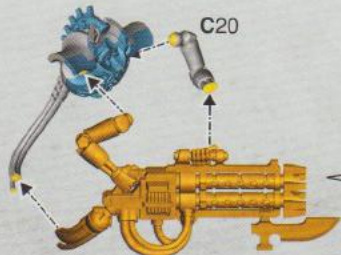
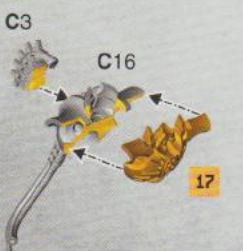

19 ≤5

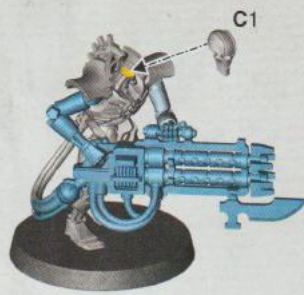
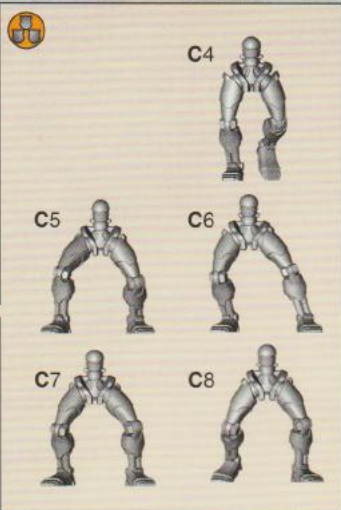

20 PLASMACYTE REANIMATOR

RÉANIMATEUR PLASMACYTE | REANIMADOR PLASMACITA
 PLASMAZYTE-REANIMATOR | PLASMACITA RIANIMATORE
 ПЛАЗМАЦИТ РЕАНИМАТОР | ПЛАЗМАСАЙТ-РИАНИМЕЙТЕР
 重生等离子虫 | プラズマサイト・リアニメーター

21 PLASMACYTE ACCELERATOR

ACCELÉRATEUR PLASMACYTE | ACELERADOR PLASMACITA
 PLASMAZYTE-BESCHLEUNIGER | PLASMACITA ACCELERATORE
 ПЛАЗМАЦИТ УСКОРИТЕЛЬ | ПЛАЗМАСАЙТ-АКСЕРАЛЕЙТЕР
 加速等离子虫 | プラズマサイト・アクセラレイター

20

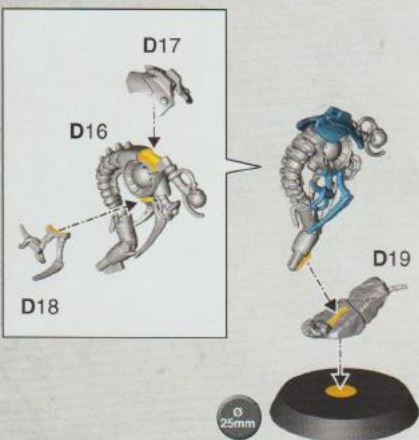

21

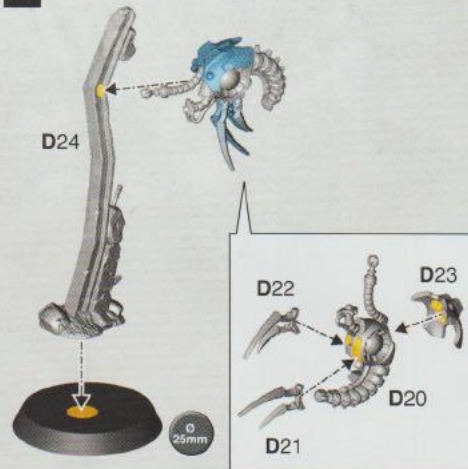

✓ 13-21

