



Free Downloads of Build Instructions,  
Assembly Booklets & How To Guides

**BuildInstructions.com**

WARHAMMER  
40,000  
**KILL TEAM**

**GALLOWFALL.**



**INTENSE BOARDING ACTIONS IN THE 41ST MILLENNIUM**







A



Ø 28mm x10



B



C



D



Ø 32mm x10

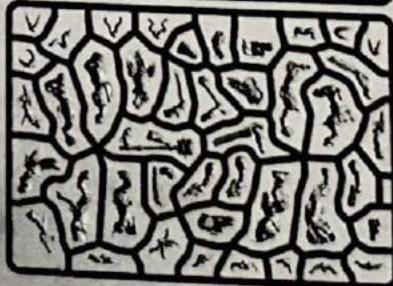

x2

**KILLZONE:  
GALLOWDARK**

KILLZONE: GALLOWDARK | ZONA DE ANIHILACIÓN: HORCASOMBRA  
KILLZONE: GALGENSCHWÄRZE | KILLZONE: PATIBOLO NERO  
БОЕВОЙ СЕКТОР: КРОМЕШНЫЙ МРАК | キルゾーン:ギャロウダーク  
杀戮区: 絞架暗淵

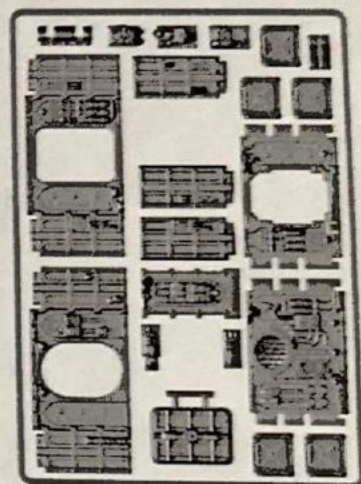
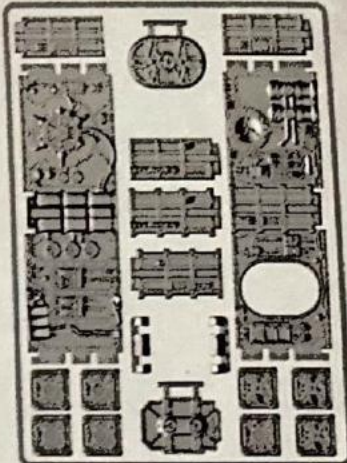
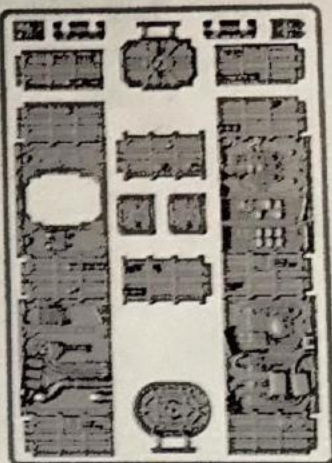

x2

**KILLZONE UPGRADE:  
GALLOWFALL**

EXTENSION DE KILLZONE: PERDITION  
MEJORA DE ZONA DE ANIHILACIÓN: HORCACADA  
KILLZONE-UPGRADE: GALGENSTURZ  
MIGLIORIE DELLA KILLZONE: LA CADUTA DEL PATIBOLO  
ДОПОЛНЕНИЕ К БОЕВОЙ ЗОНЕ: МРАЧНАЯ ПОСВЕЛЬ  
キルゾーン・アップグレード:ギャロウフォール  
杀戮区改件: 絞架之隈

G

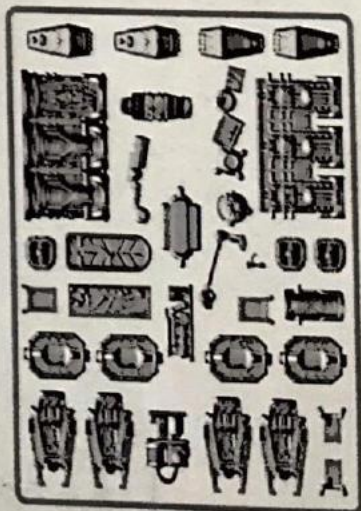



• Interchangeable Parts  
 • Éléments interchangeables  
 • Partes intercambiables

• Austauschbare Teile  
 • Componenti intercambiabili  
 • ВЗАИМОЗАМЕНЯЕМЫЕ ЧАСТИ

• 組み換え可能な部品  
 • 可互换零件

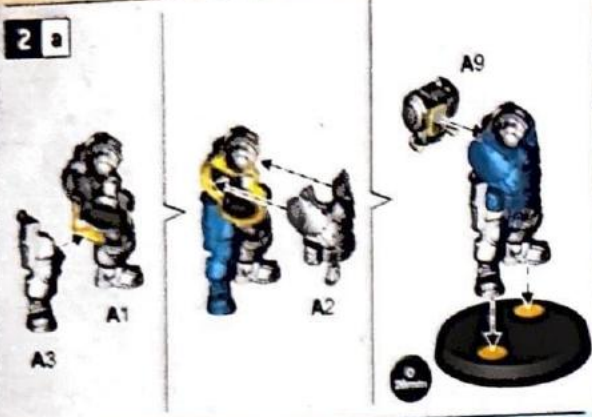

Choose the variant you want to build  
 Choisissez la variante à assembler  
 Elige qué versión quieres montar  
 Wähle die Variante, die du bauen möchtest

2 b-c x1

- Hearthlykn Theyn
- Theyn Atrakog
- Theyn Sucesor
- Flammlykn-Theyn
- Confratello del Focolare Theyn
- горнец тхайн
- ハースキン・ゼイン
- 炉心头领

2 d s9

- Hearthlykn Warrior
- Guerrier Atrakog
- Sucesor Combatiente
- Flammlykn-Krieger
- Confratello del Focolare Guerriero
- горнец воин
- ハースキン・ウォリアー
- 炉心战士

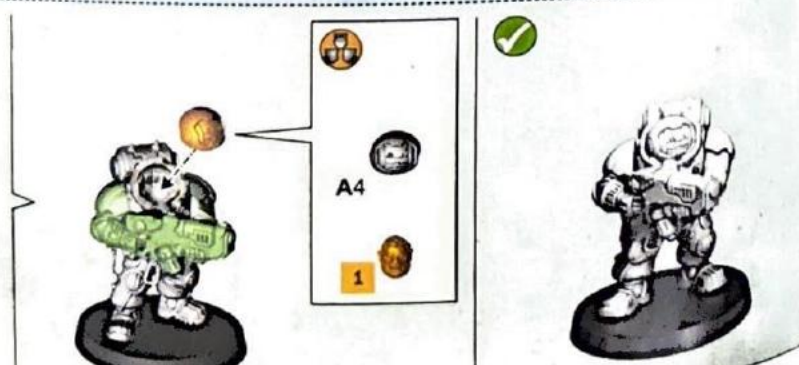
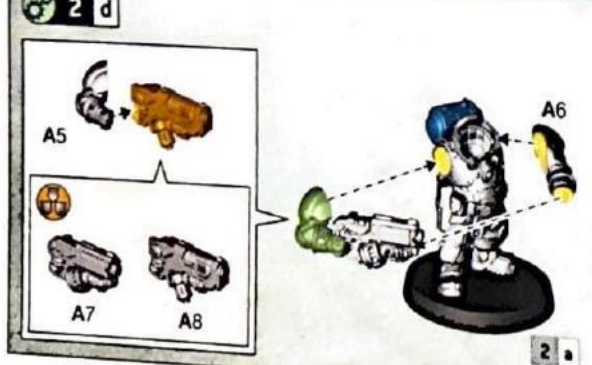
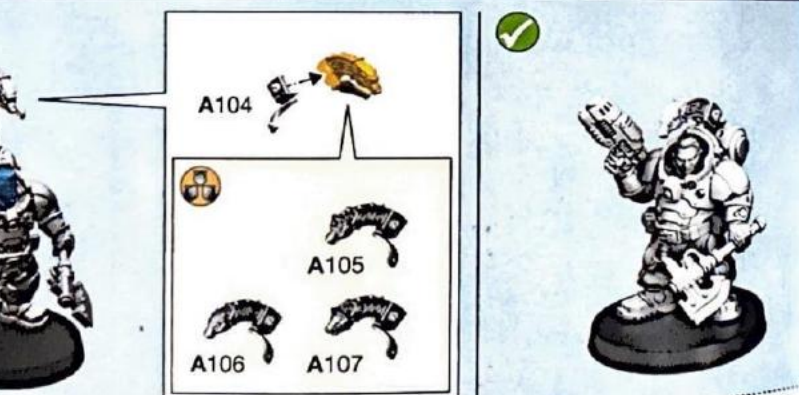
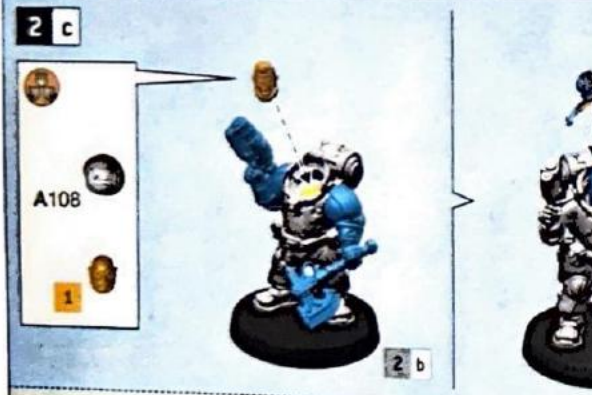
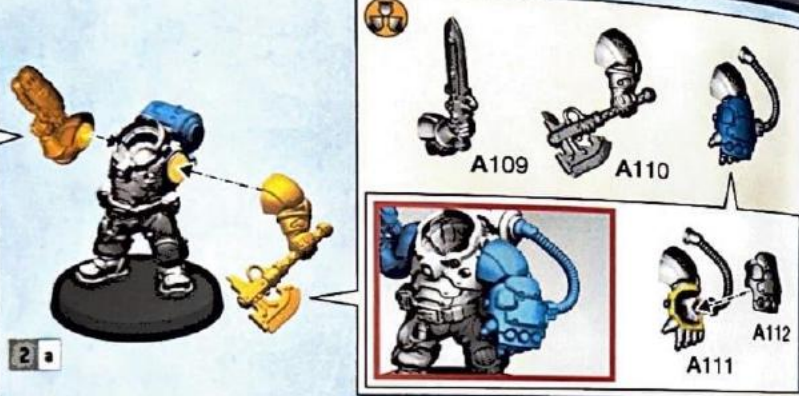
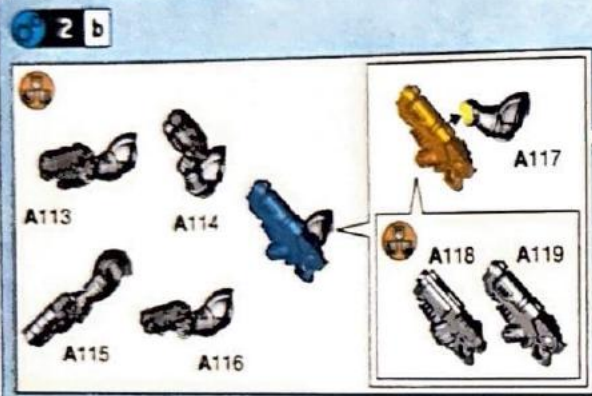





**3 b**  $\leq 9$

- Hearthkyn Warrior
- Guerrier Atrakog
- Succesor Combatente
- Flammkyn-Krieger
- Confratello del Focolare Guerriero
- горнецъ воинъ
- ハースキン・ウォリアー
- 炉心战士

**3 c**  $\leq 3$

- Hearthkyn Gunner
- Mitrailleur Atrakog
- Succesor Tirador
- Flammkyn-Schütze
- Confratello del Focolare Artigliere
- горнецъ канонеръ
- ハースキン・ガンナー
- 炉心炮手

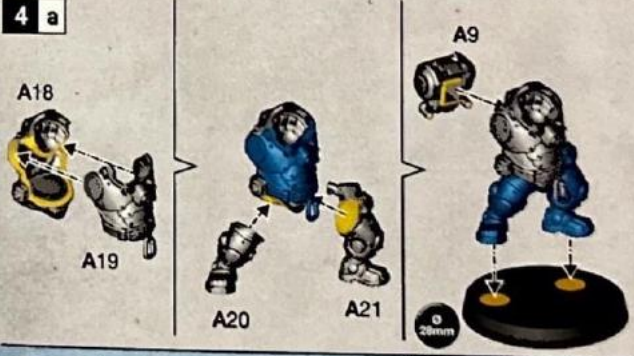
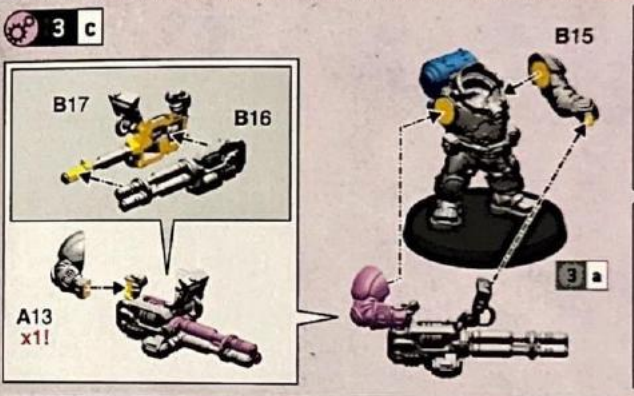
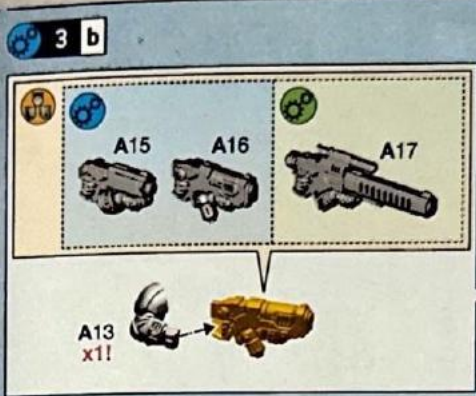

**4 b**  $\leq 9$

- Hearthkyn Warrior
- Guerrier Atrakog
- Succesor Combatente
- Flammkyn-Krieger
- Confratello del Focolare Guerriero
- горнецъ воинъ
- ハースキン・ウォリアー
- 炉心战士

**4 c**  $\leq 1$

- Hearthkyn Dözer
- Dözer Atrakog
- Succesor Bulldözer
- Flammkyn-Dözer
- Confratello del Focolare Dözer
- горнецъ дозър
- ハースキン・ドーザー
- 炉心履帯士

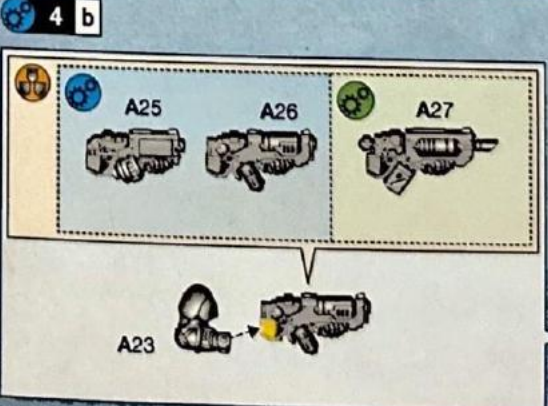



4 c



5 a



5 b ≤9



- Hearthkyn Warrior
- Guerrier Atrekog
- Sucesor Combatiente
- Flammkyn-Krieger
- Confratello del Focolare Guerriero
- горнец воин
- ハースキン・ウォリアー
- 炉心战士

≤3



- Hearthkyn Gunner
- Mitrailleur Atrekog
- Sucesor Tirador
- Flammkyn-Schütze
- Confratello del Focolare Artigliere
- горнец канонир
- ハースキン・ガンナー
- 炉心炮手

5 c



- Hearthkyn Linger
- Mule Atrekog
- Sucesor alijero
- Flammkyn-Schlepper
- Confratello del Focolare Carro
- горнец тяжеловоз
- ハースキン・ラガー
- 炉心搬運士

5 b

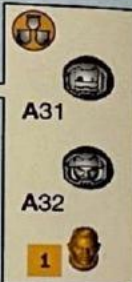
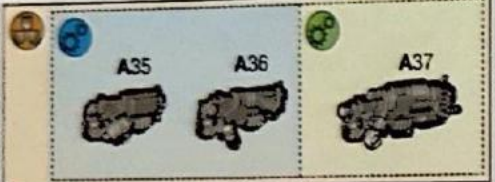

5 a



5 c



6 a



6 b ≤9



- Hearthkyn Warrior
- Guerrier Atrekog
- Sucesor Combatiente
- Flammkyn-Krieger
- Confratello del Focolare Guerriero
- горнец воин
- ハースキン・ウォリアー
- 炉心战士

≤3



- Hearthkyn Gunner
- Mitrailleur Atrekog
- Sucesor Tirador
- Flammkyn-Schütze
- Confratello del Focolare Artigliere
- горнец канонир
- ハースキン・ガンナー
- 炉心炮手



6 b

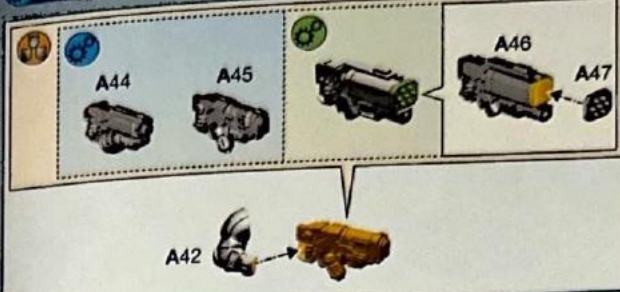

7 a

- Hearthkyn Warrior
- Guerrier Atrskog
- Sucesor Combatiente
- Flammkyn-Krieger
- Confratello del Focolare Guerriero
- горняк боец
- ハースキン・ウォリアー
- 炉心战士

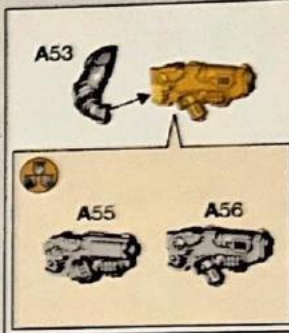

7 b

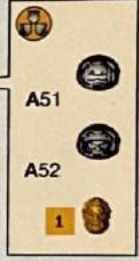

8 a



<p>8 b</p> <ul style="list-style-type: none"> <li>• Hearthkyn Warrior</li> <li>• Guerrier Atrskog</li> <li>• Sucesor Combatiente</li> <li>• Flammkyn-Krieger</li> <li>• Confratello del Focolare Guerriero</li> <li>• горняк боец</li> <li>• ハースキン・ウォリアー</li> <li>• 炉心战士</li> </ul>	<p>8 c</p> <ul style="list-style-type: none"> <li>• Hearthkyn Field Medic</li> <li>• Médic de Terrain Atrskog</li> <li>• Sucesor Médico de campo</li> <li>• Flammkyn-Feldsanitäter</li> <li>• Confratello del Focolare Medico de Campo</li> <li>• горняк полевой медик</li> <li>• ハースキン・フィールドメディック</li> <li>• 炉心战地医疗兵</li> </ul>	<p>8 d</p> <ul style="list-style-type: none"> <li>• Hearthkyn Grenadier</li> <li>• Grenadier Atrskog</li> <li>• Sucesor Granadero</li> <li>• Flammkyn-Granadier</li> <li>• Confratello del Focolare Granatiere</li> <li>• горняк гранатер</li> <li>• ハースキン・グレネーティア</li> <li>• 炉心掷弹兵</li> </ul>
---	--	--

8 b

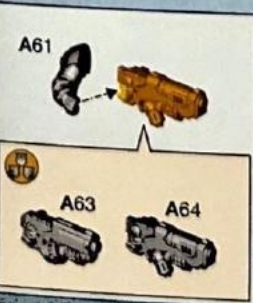



**8 c**

A120  
A121  
A65  
A102  
A122  
A103  
A60  
1

**8 d**

A9  
B5  
B6  
B7  
A123  
B4  
B8  
B9

**9 a**

A66  
A67  
A68

**9 b-c**

**9 d-e**

**9 b**

• Hearthlyn Warrior • Guerrier Atrekog  
 • Succesor Combattente • Flammkugl-Krieger  
 • Confratello del Focolare Guerriero  
 • горнец воин с прыжковым ранцем  
 • ハースキン・ジャンプバック・ウォリアー  
 • 炉心跳び背包装士

**9 c**

A6  
A70  
A71  
A72  
A73  
A69  
1

**9 d**

B27  
A9  
B26  
B24



**9 c**

B28  
B30 B29

**9 d**



**10 a**

A74  
A75  
A76

30mm

**10 b** ≤9

**10 c** ≤1

- Hearthlyn Warrior • Guerrier Atrérog
- Succesor Combatiente • Flammkyn-Krieger
- Confratello del Focolare Guerriero • горняк родової свавіст
- ハースキン・ウォリアー • 守心戦士

- Hearthlyn Kintynk • Cogtamm Atrérog
- Succesor radiavinculade • Flammkyn-Kömmkyn
- Confratello del Focolare Kännektz
- горняк родової свавіст
- ハースキン・キンリンク • 守心氏族通訊兵

**10 b**

A79  
A81 A82  
A9 A80

**10 a**

A77

**10 c**

A100 x1!  
A101 x1!  
A83 A84

**10 a**

A78  
A158

**11 a**

A85  
A86  
A87

30mm

**11 b** ≤9

**11 c** ≤1

**11 d** ≤1

- Hearthlyn Warrior
- Guerrier Atrérog
- Succesor Combatiente
- Flammkyn-Krieger
- Confratello del Focolare Guerriero
- горняк родової свавіст
- ハースキン・ウォリアー
- 守心戦士

- Hearthlyn Lokätr
- Lokätr Atrérog
- Succesor Locätrader
- Flammkyn-Lokätr
- Confratello del Focolare Lokätr
- горняк ЛОКАТР
- ハースキン・ロケイター
- 守心職定士

- Hearthlyn Kognitär
- Kognitär Atrérog
- Succesor Anälista
- Flammkyn-Kognitär
- Confratello del Focolare Kognitär
- горняк КОГНАТР
- ハースキン・コグニター
- 守心愚専士



11 b

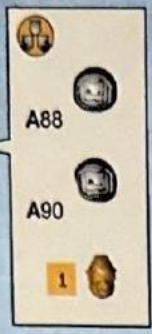
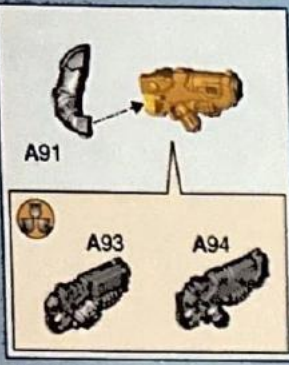

11 c

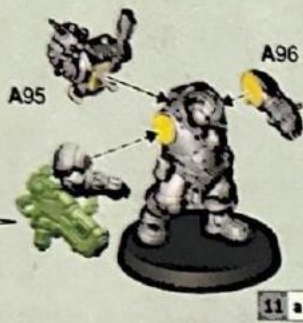
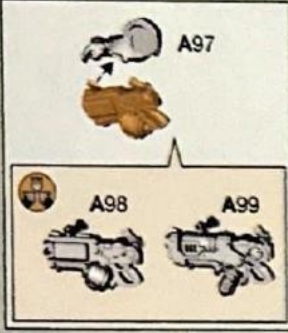

11 d

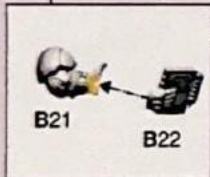

12

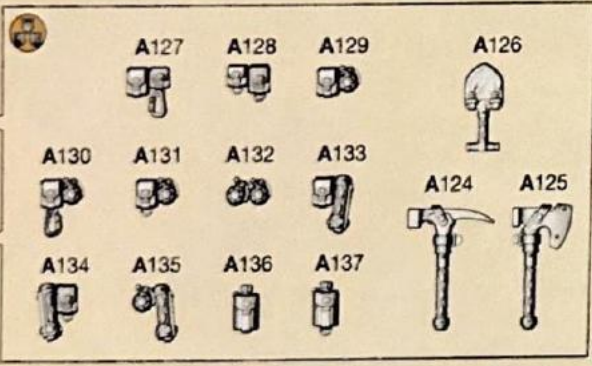

**CITADEL COLOUR**

ENG More painting guides can be found on [citadelcolour.com](http://citadelcolour.com)  
 FNE Pour plus de guides de peinture sur [citadelcolour.com](http://citadelcolour.com)  
 SPA Encuentra más guías de pintura en [citadelcolour.com](http://citadelcolour.com)  
 GER Weitere Bemalungstipps auf [citadelcolour.com](http://citadelcolour.com)  
 ITA Per trovare altre guide alla pittura su [citadelcolour.com](http://citadelcolour.com)  
 RUS Дополнительные инструкции по покраске на сайте [citadelcolour.com](http://citadelcolour.com)  
 JPN [citadelcolour.com](http://citadelcolour.com)には他にも様々なペイントガイドが掲載されています。  
 中文 更多涂装指南请在 [citadelcolour.com](http://citadelcolour.com)





- Interchangeable Parts
- Éléments interchangeables
- Partes intercambiables

- Austauschbare Teile
- Componenti intercambiabili
- ВЗАИМОЗАМЕНЯЕМЫЕ ЧАСТИ

- 組み換え可能な部品
- 可互换零件

13

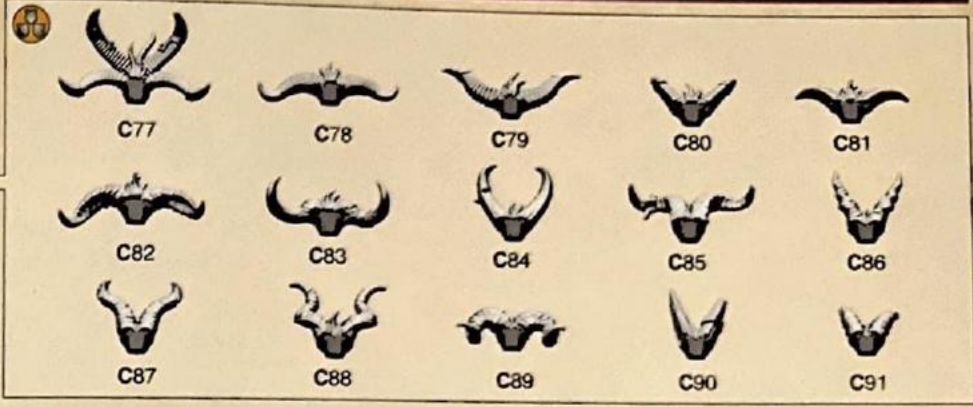

13

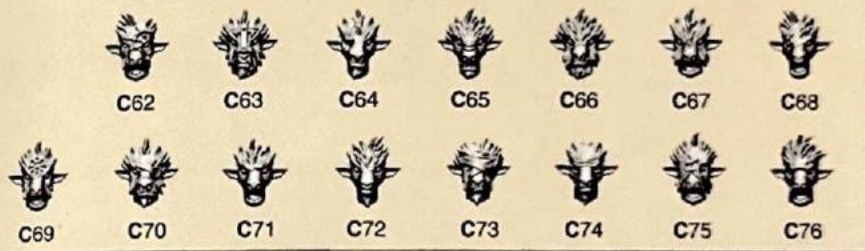

14 a

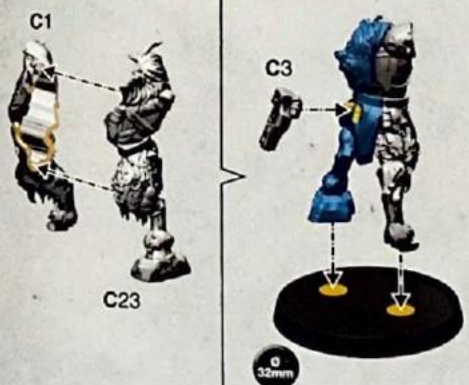

- Choose the variant you want to build
- Choisissez la variante à assembler
- Elige qué versión quieres montar
- Wähle die Variante, die du bauen möchtest
- Scegli la variante che vuoi assemblare
- Выберите тот вариант, который хотите собрать
- 組み立てバリエーションの選択
- 选择你喜欢的拼装方式

14 b x1



14 c x9



14 c x9



- Fellgor Ironhorn • Cornéfer Affreger • Expollagor Cuernoférrea • Finstertgor-Eisenhorn
- Malgor Horn of Iron • Валгортт халезнор • Феллгоулр-Айан-Һорн
- 惡角鐵角頭
- Fellgor Warrior • Guerrier Affreger
- Expollagor Combattente • Finstertgor-Krieger
- Malgor Guerrier • Валгортт вои • Феллгоулр-Волиер
- 惡角戰士

14 b





14 c



14 b



15 a



C13

13



15 b



15 c

• Feliger Warrior • Guerrier Affreger  
 • Expoliator Combattiente • Finstertor-Krieger  
 • Malogor Guerriero • валгоор воин  
 • フェルゴウル・ウォリアー • 悪角番战士

• Feliger Vandal • Vandale Affreger  
 • Expoliator Vandale • Finstertor-Vandale  
 • Malogor Vandale • валгоор вандал  
 • フェルゴウル・ヴァンダル • 悪角番破坏者

15 b



15 a

15 c



15 a



16 a



C19



16 b



16 c

• Feliger Warrior • Guerrier Affreger  
 • Expoliator Combattiente • Finstertor-Krieger  
 • Malogor Guerriero • валгоор воин  
 • フェルゴウル・ウォリアー • 悪角番战士

• Feliger Herd god • Fouette-herde Affreger  
 • Expoliator Domador • Finstertor-Paltchar  
 • Malogor Mandriano • валгоор стадогон  
 • フェルゴウル・ヘッドゴード  
 • 悪角番番师

16 b



16 a

16 c



16 a





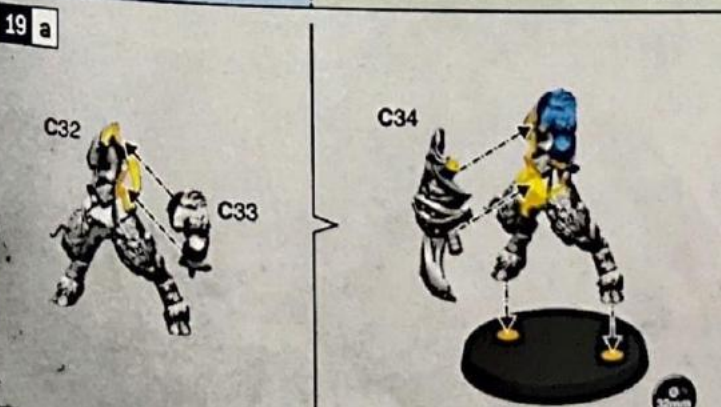
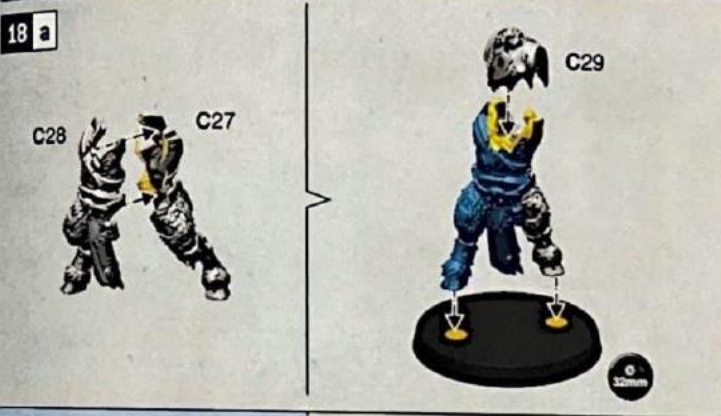
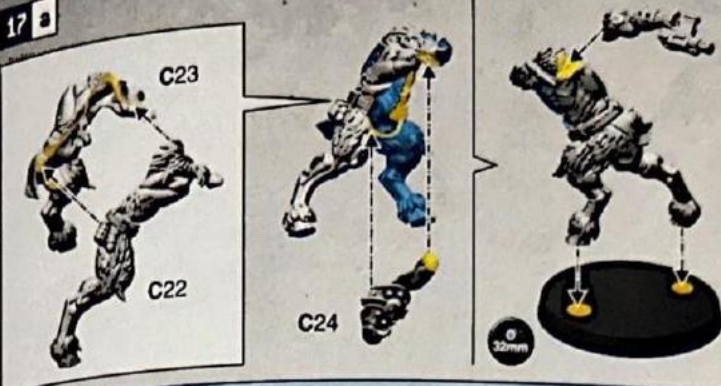



19 b

C37

19 a



13

C38

C35



19 c

D11

D12

C36

19 a



D15

D14

D13



20 a

C39

C40

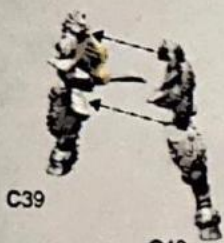

C41

30mm



20 b ≤9



20 c ≤1



• Feliger Warrior • Guerrier Affreger  
• Espoligor Combatiente • Finstergor-Krieger  
• Maligor Guerriero • narropp som  
• フェルゴウル・ウォリアー • 悪角番战士

• Feliger Mangler • Broyeur Affreger  
• Espoligor Triburador • Finstergor-Brecher  
• Maligor Massacrator • narropp kromstalt  
• フェルゴウル・マングレー • 悪角番戦犯

20 b

C42

C43

20 a



20 c

D17

D16

20 a



21 a

C44

C45



C46

30mm



21 b ≤9



• Feliger Warrior • Guerrier Affreger  
• Espoligor Combatiente • Finstergor-Krieger  
• Maligor Guerriero • narropp som  
• フェルゴウル・ウォリアー • 悪角番战士

• Feliger Gnarlcar • Balatré Affreger  
• Espoligor Portaiacras  
• Finstergor-Venarbit • Maligor Strigato  
• narropp krosoupam  
• フェルゴウル・ナールスカー  
• 悪角番戦犯



**21 b**

C48 C49

**21 a**

13

D21 D22

C47

D19 D20

**22 a**

C50 C51 C52

30mm

**22 b** ⚡9

**22 c** ⚡1

• Feliger Warrior • Guerrier Affregor  
 • Expoliator Combatiante • Finstertag-Krieger  
 • Malegor Guerriero • sa/rropp bowe  
 • フェルゴウル・ウォリアー • 悪魔戦士

• Feliger Tscham • Tschicoma Affregor  
 • Expoliator Putricuerno • Finstertag-Gifhorn  
 • Malegor Tschicoma • sa/rropp 42000r  
 • フェルゴウル・トクスホーン • 悪魔戦士

**22 b**

13

C55 C56 C53

**22 a**

**22 c**

D23 D24 D25

**22 a**

30mm

C54

D26

**22 c** ⚡1

**23 a**

C57 C58

C59

30mm

**23 b** ⚡9

**23 c** ⚡1

• Feliger Warrior • Guerrier Affregor  
 • Expoliator Combatiante • Finstertag-Krieger  
 • Malegor Guerriero • sa/rropp bowe  
 • フェルゴウル・ウォリアー • 悪魔戦士

• Feliger Fluxbrag • Braillexus Affregor  
 • Expoliator Fluxegrey • Finstertag-Wandelhorn  
 • Malegor Barcia del Fluss • sa/rropp matopde  
 • フェルゴウル・フラックスビュレイ  
 • 悪魔戦士



23 b



23 c

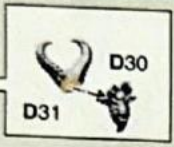

ENG [www.painting-guides.com/en/citadelcolour.com](http://www.painting-guides.com/en/citadelcolour.com)  
 FRA [www.guides-de-peinture.com/fr/citadelcolour.com](http://www.guides-de-peinture.com/fr/citadelcolour.com)  
 SPA [www.guias-de-pintura.com/es/citadelcolour.com](http://www.guias-de-pintura.com/es/citadelcolour.com)  
 GER [www.malereisunguide.com/de/citadelcolour.com](http://www.malereisunguide.com/de/citadelcolour.com)

ITA Puoi trovare altre guide alla pittura su [citadelcolour.com](http://citadelcolour.com)  
 RUS Дополнительные инструкции по покраске на сайте [citadelcolour.com](http://citadelcolour.com)  
 JPN citadelcolour.com には他にも様々なペイントガイドが掲載されている  
 CHN 更多涂装指南请至 [citadelcolour.com](http://citadelcolour.com).



CITADEL  
COLOUR



24 12

Short Wall with Hatchway and Pillars  
 Mur Court avec Écouteille et Piliers  
 Muro corto con escotilla y pilares  
 Kurze Wand mit Schott und Säulen  
 Muro corto con boccaporto e colonne  
 Короткая стена с люком и опорами  
 短壁 (ハッチ、柱付き)  
 有支柱和舱门过道的短墙壁

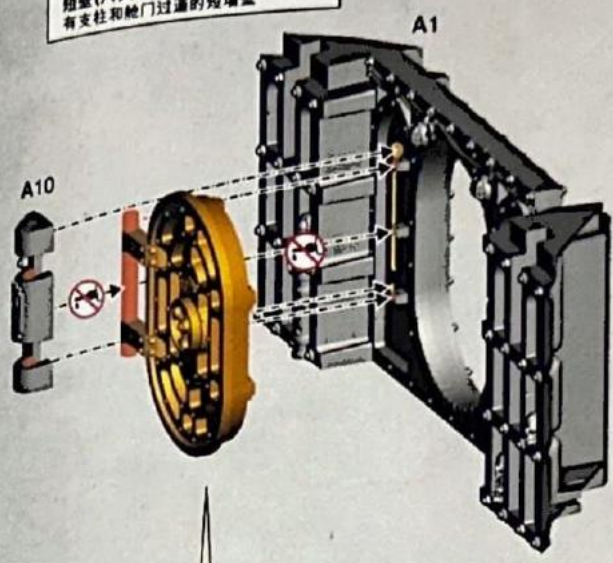

25 12

Short Wall with Hatchway and Pillars  
 Mur Court avec Écouteille et Piliers  
 Muro corto con escotilla y pilares  
 Kurze Wand mit Schott und Säulen  
 Muro corto con boccaporto e colonne  
 Короткая стена с люком и опорами  
 短壁 (ハッチ、柱付き)  
 有支柱和舱门过道的短墙壁

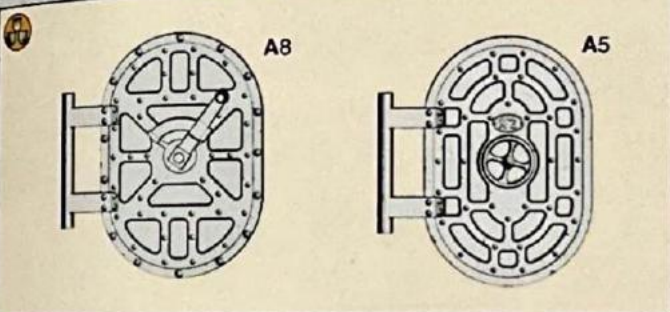
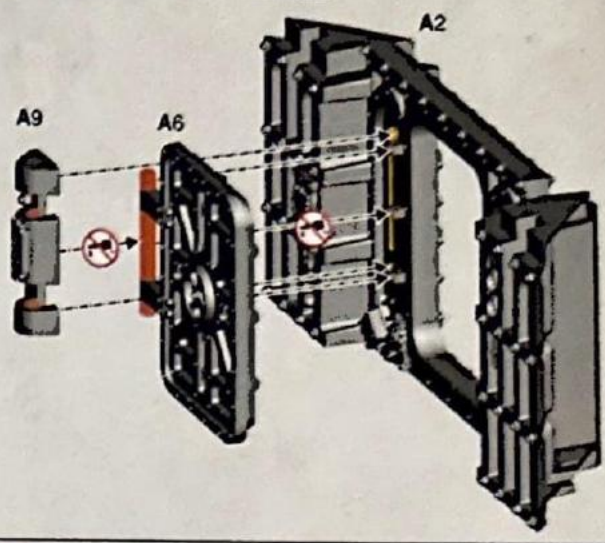

26 12

Short Wall with Hatchway  
 Mur Court avec Écouteille  
 Muro corto con escotilla  
 Kurze Wand mit Schott  
 Muro corto con boccaporto  
 Короткая стена с люком  
 短壁 (ハッチ付き)  
 有舱门过道的短墙壁

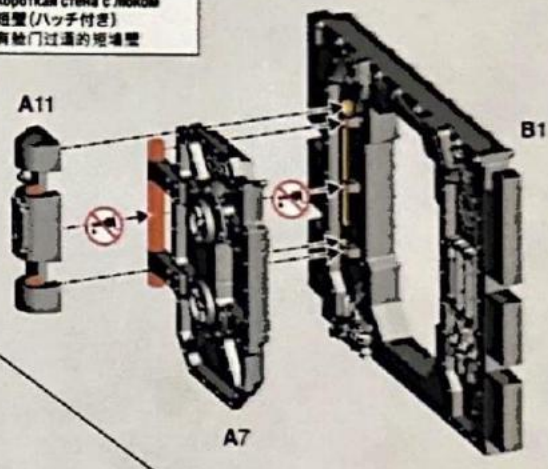

27 12

Long Wall with Hatchway and Pillars  
 Mur Long avec Écouteille et Piliers  
 Muro largo con escotilla y pilares  
 Lange Wand mit Schott und Säulen  
 Muro lungo con boccaporto e colonne  
 Длинная стена с люком и опорами  
 长壁 (ハッチ、柱付き)  
 有支柱和舱门过道的长墙壁

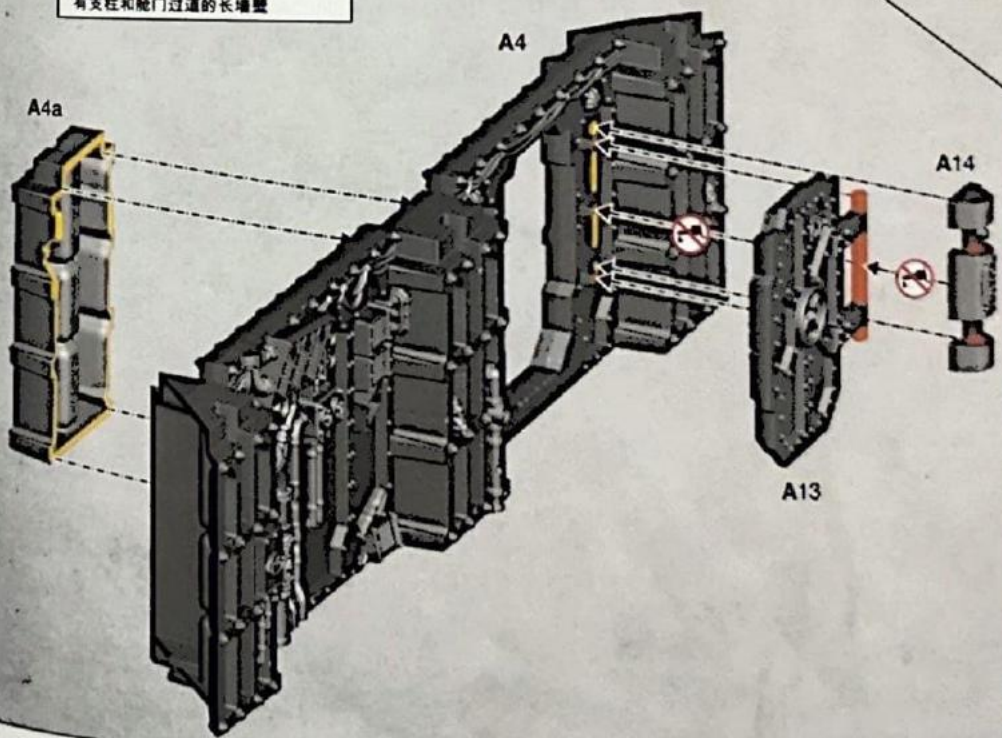



28 x2

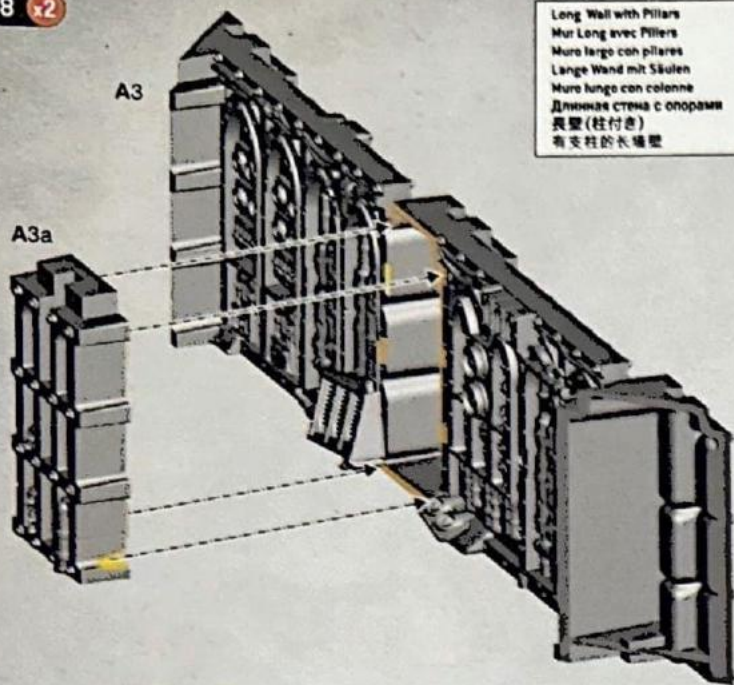

Long Wall with Pillars  
 Mur Long avec Piliers  
 Muro largo con pilares  
 Lange Wand mit Säulen  
 Muro lungo con colonne  
 Длинная стена с опорами  
 長壁 (柱付き)  
 有支柱的长墙壁

29 x2

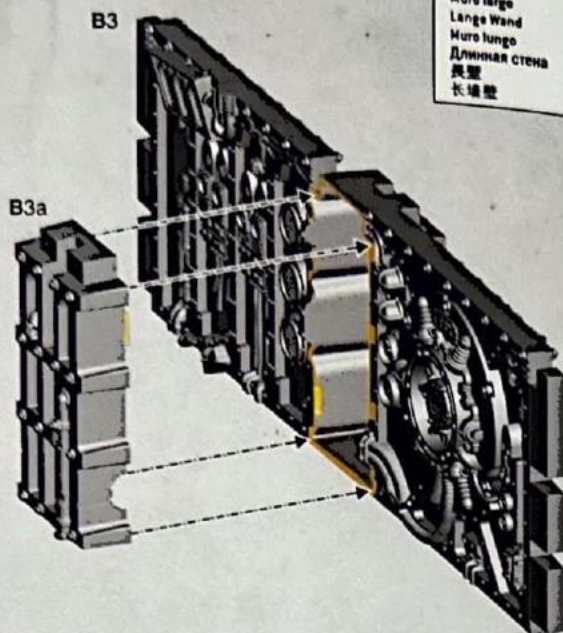

Long Wall  
 Mur Long  
 Muro largo  
 Lange Wand  
 Muro lungo  
 Длинная стена  
 長壁  
 长墙壁

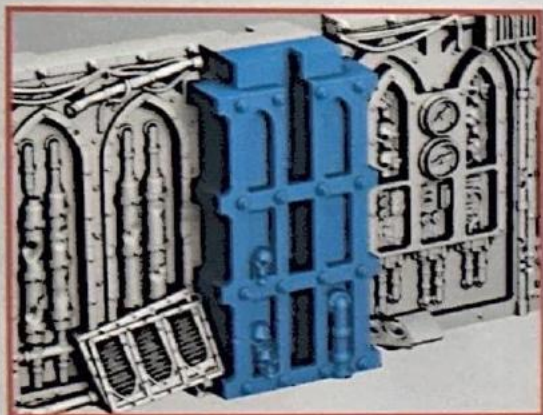

30 x2

Short Wall  
 Mur Court  
 Muro corto  
 Kurze Wand  
 Muro corto  
 Короткая стена  
 短壁  
 短墙壁

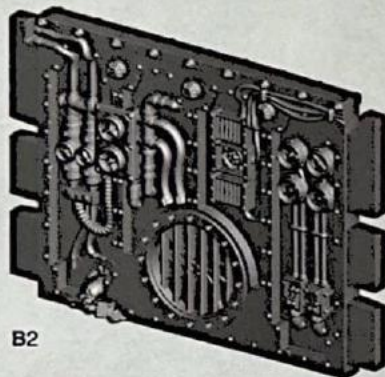

31 x2

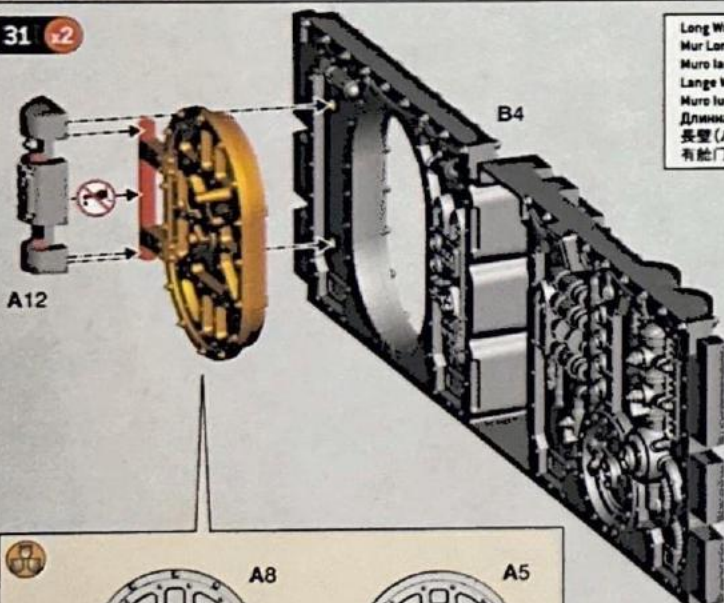

Long Wall with Hatchway  
 Mur Long avec Écoutille  
 Muro largo con escotilla  
 Lange Wand mit Schott  
 Muro lungo con boccaporto  
 Длинная стена с люком  
 長壁 (ハッチ付き)  
 有舱门过道的长墙壁

B4a

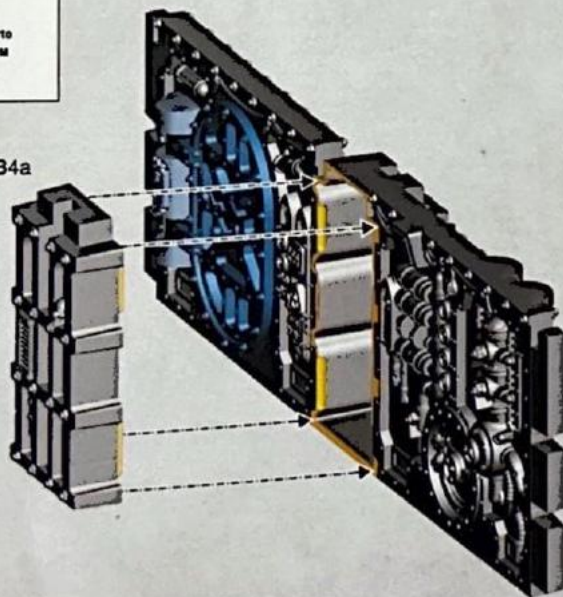

A8

A5

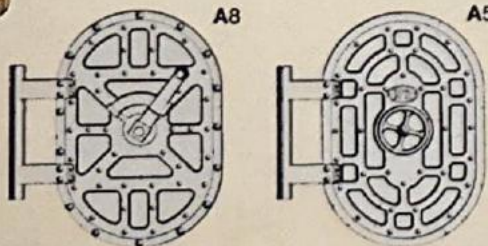



32 x16

Plaf  
Plaf  
Plaf  
Sbalco  
Catenina  
Отгора  
柱  
支柱

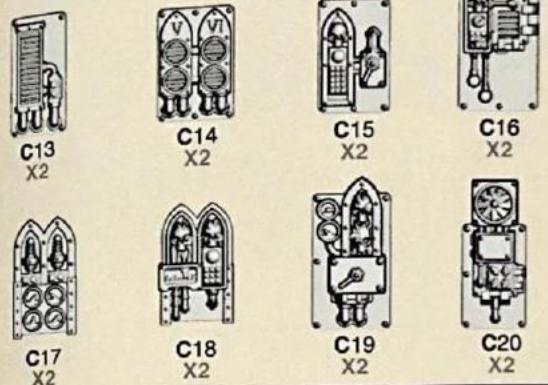
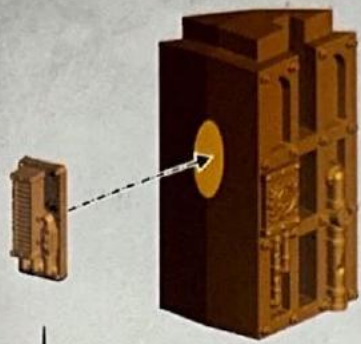

33 x2

Wall End  
Extremità de Mur  
Borde de Muro  
Wandende  
Estremità del muro  
Край стены  
壁の端  
墙壁末端

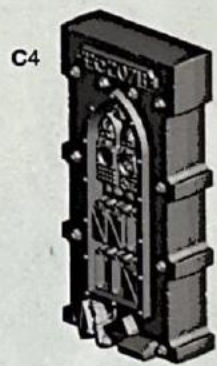

L

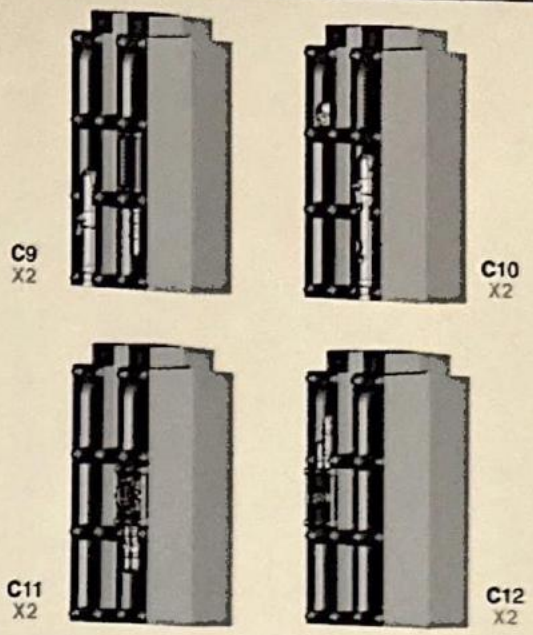

R

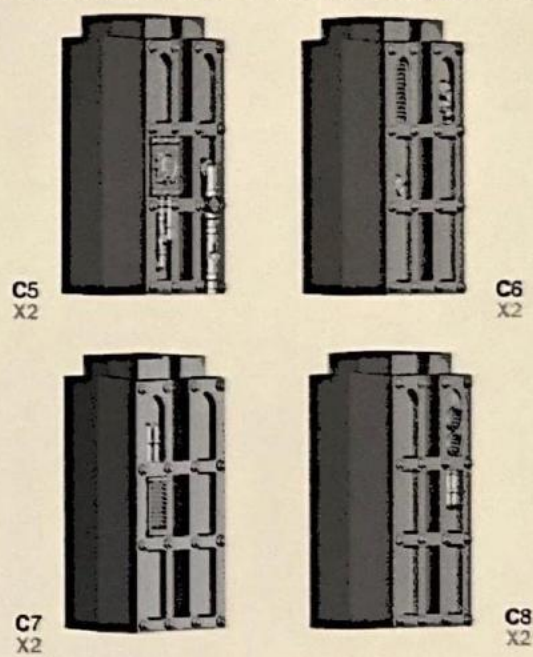

34 - 39

KILLZONE UPGRADE:  
GALLOWFALL

ESTENSIONE DE KILLZONE - PERDITION | MEJORA DE ZONA DE ANIQUILACION: HORCACADA | KILLZONE UPGRADE: GALLOWFALL  
MIGLIORIE DELLA KILLZONE - LA CADUTA DEL PATIBOLO | ДОПОЛНЕНИЕ К БОЕВОЙ ЗОНЕ: МРАЧНАЯ ПОГИБЕЛЬ  
キルゾーン・アップグレード: キャロウフォール | 杀罪区改件: 绝望之塔

34 x8

Escape Pods  
Mòduls de Sauvetaje  
Cápsulas de escape  
Flucht kapseln  
Capsule di Salvataggio  
спасательные капсулы  
脱出ポッド  
逃生舱





35 x2

Autopsy Table  
Table d'Autopsie  
Mesa de autopsias  
Autopsietisch  
Tavolo Autortico  
Стол для вскрытия  
解剖台

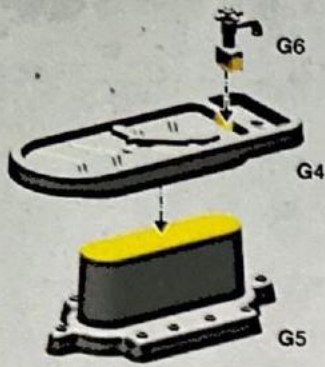

36 x2

Iron Lung  
Respirateur  
Pulmón de acero  
Eiserne Lunge  
Polmone d'Acciaio  
Железное лёгкое  
人工呼吸器  
铁肺

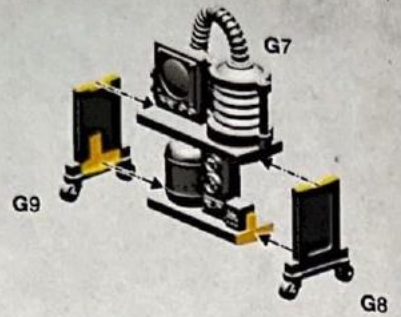

37 x2

Medical Supply Table  
Chariot de Service Médical  
Mesa de material médico  
Medizinischer Versorgungstisch  
Tavolo Portstrumenti  
Медицинский стол  
医療物資台

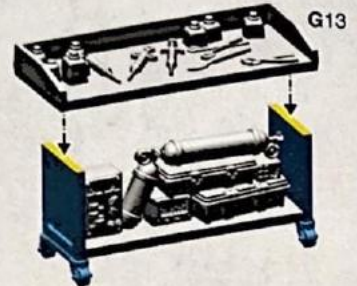
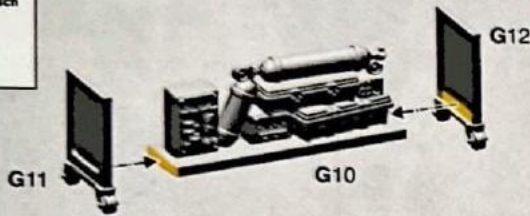

38 x2

Surgical Chair  
Fauteuil de Chirurgie  
Silla quirúrgica  
Chirurgiestuhl  
Poltrona Chirurgica  
Хирургическое кресло  
手術用椅子  
手术椅

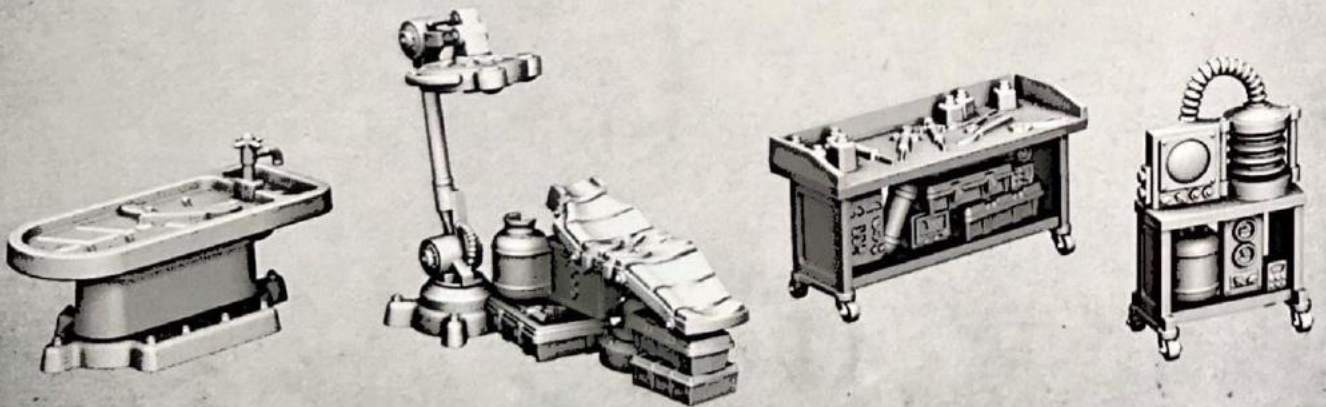
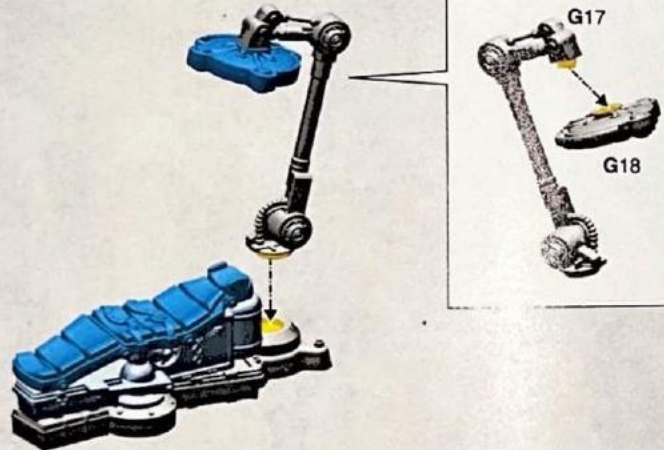
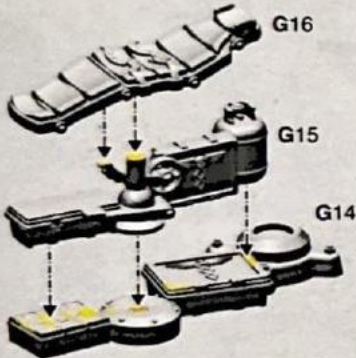



Stazio Podu  
Modulos de Stazio  
Cápsulas de estacio  
Staatkaposeln  
Capsule di Stazi  
Станционные капсулы  
駅舎ポッド

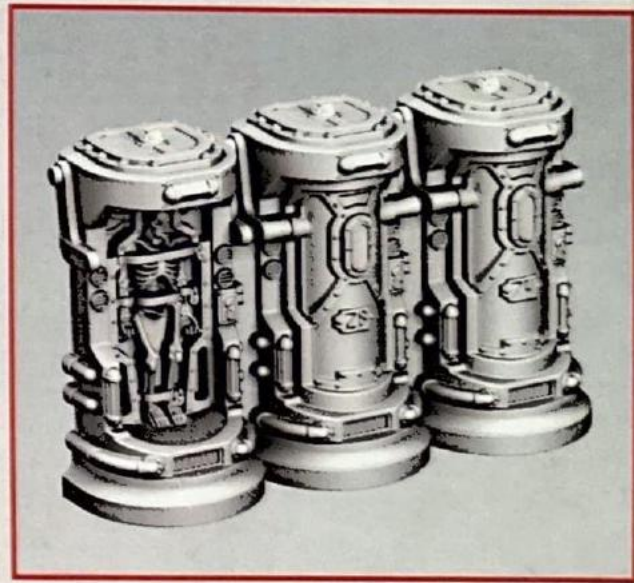
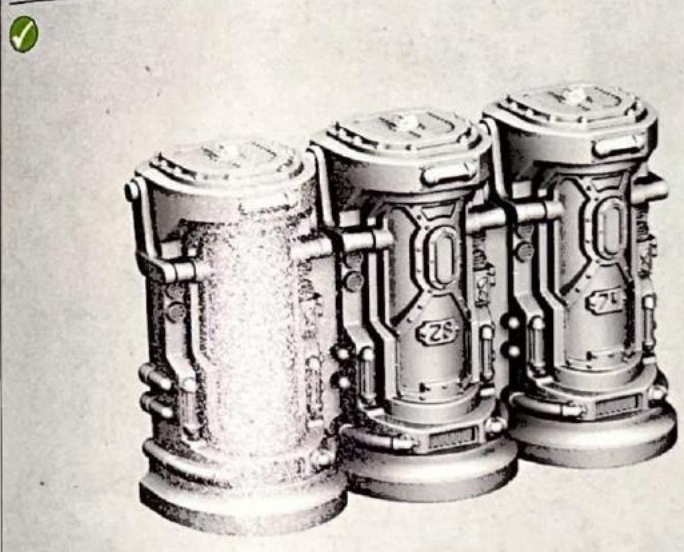
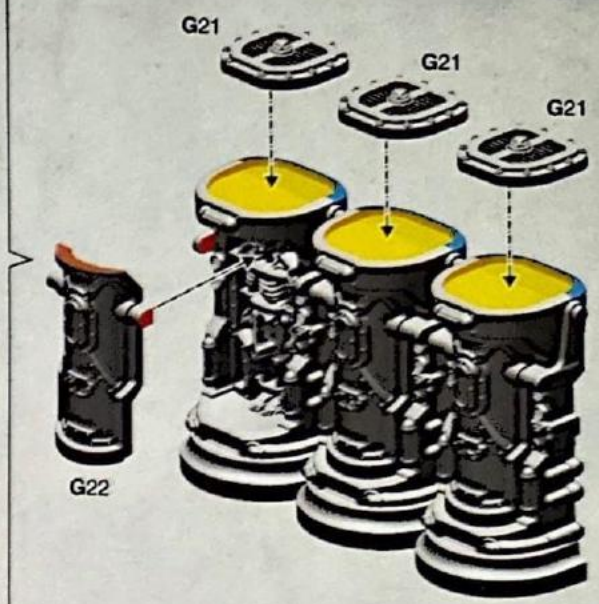
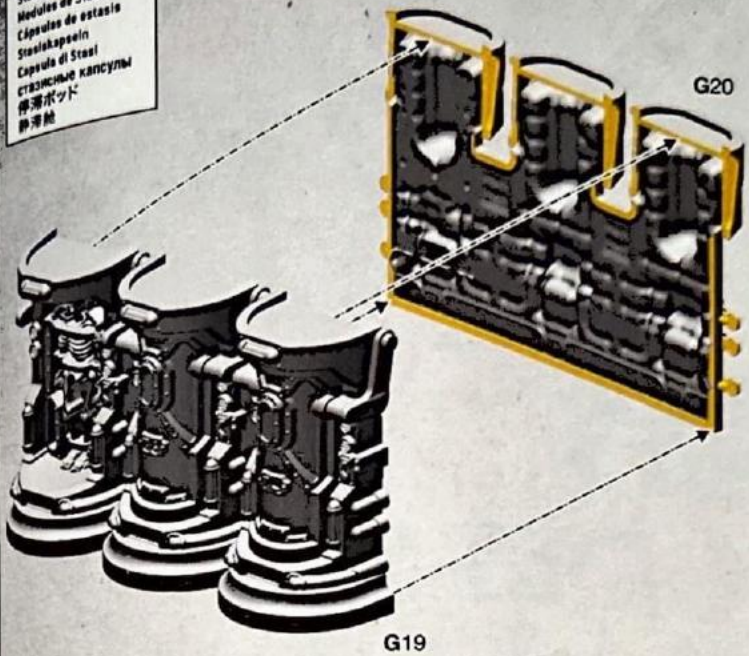





• Example Assemblies  
• Exemples d'Assemblages  
• Ejemplos de montaje

• Beispiele  
• Esempi di assemblaggio  
• ОБРАЗЦЫ СБОРКИ

• 組み立ての例  
• 装配示例

! 40

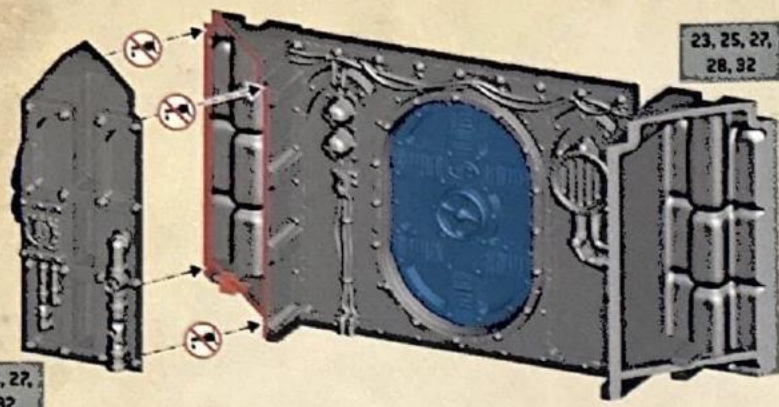

23, 25, 27,  
28, 32

24, 25, 27,  
28, 32

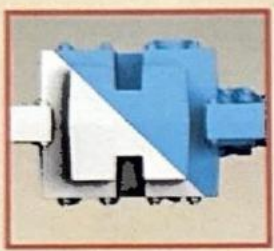
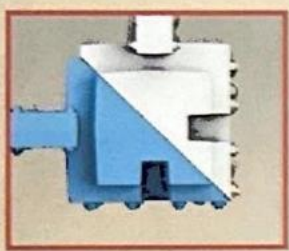

32

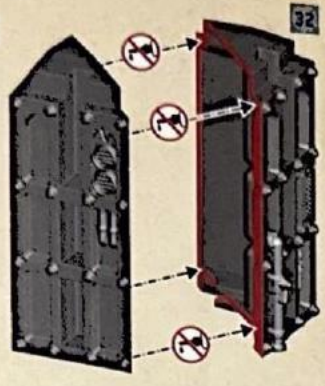

32



! 41



C1  
X10



C2  
X10



C3  
X10

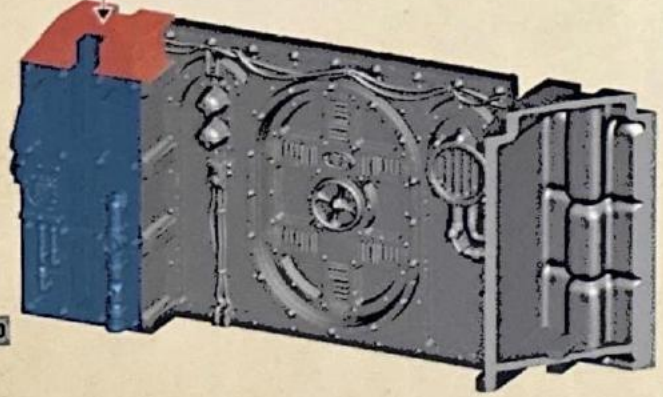

40

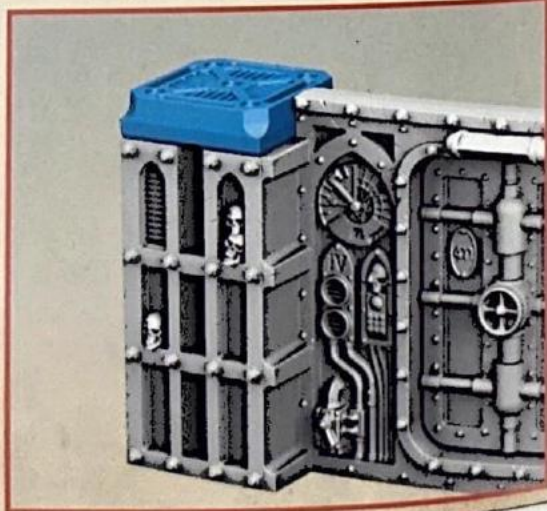



! 42 a

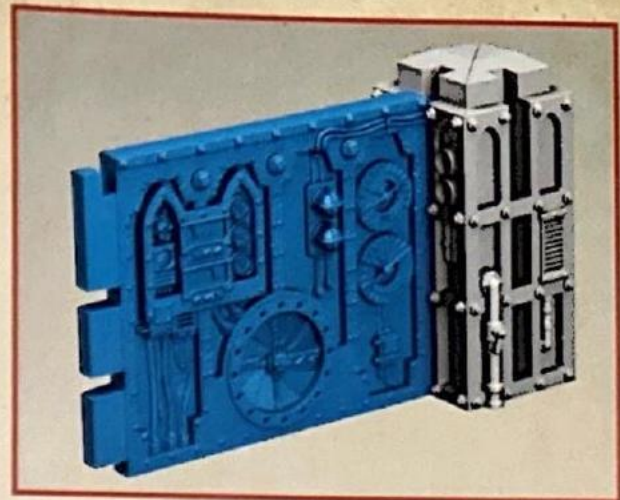
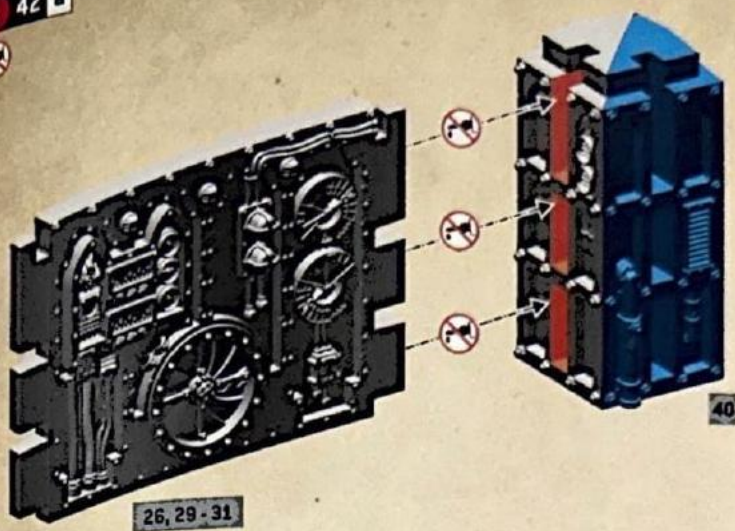

! 42 b

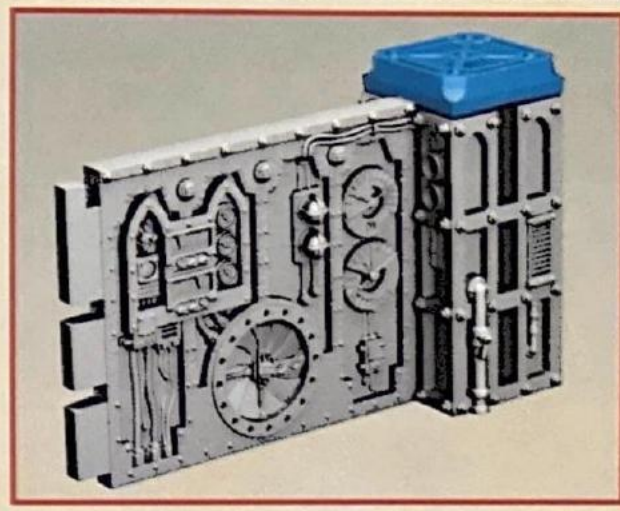
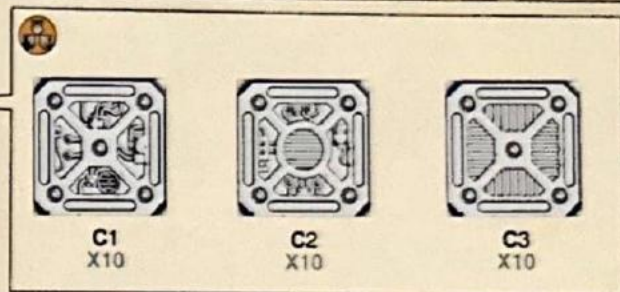
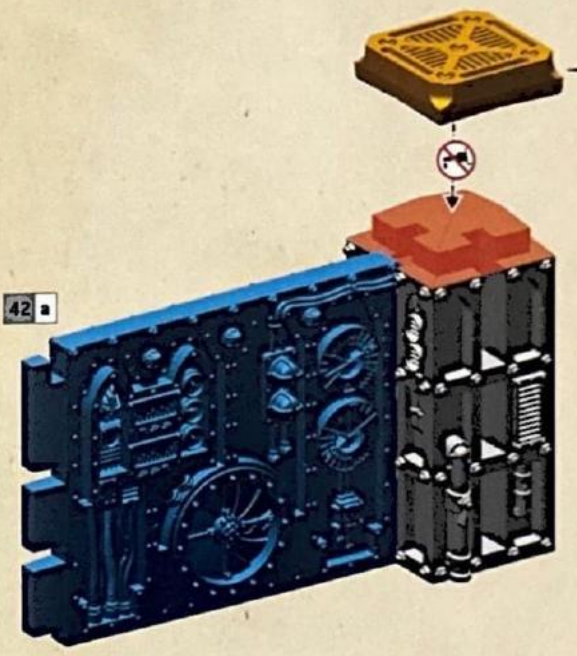

! 43

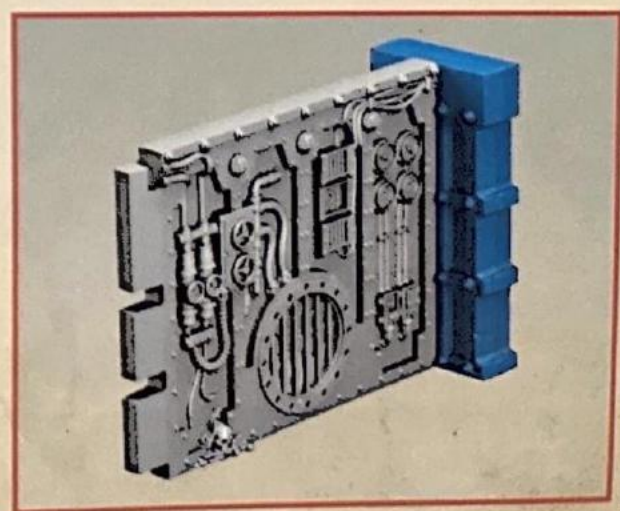
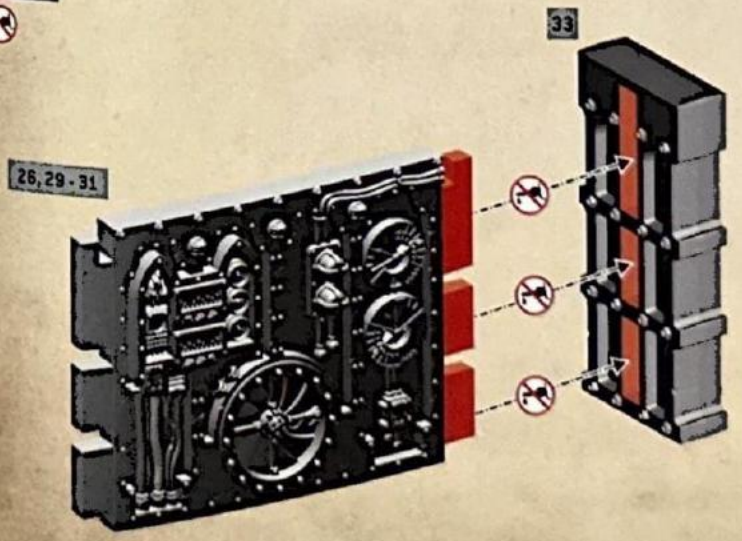





ENG Your painting guides can be found on [citadelcolour.com](http://citadelcolour.com)  
 FRA Vos guides de peinture sont disponibles [citadelcolour.com](http://citadelcolour.com)  
 SPA Consulta más guías de pintura en [citadelcolour.com](http://citadelcolour.com)  
 GER Besuche Malerleitfänger auf [citadelcolour.com](http://citadelcolour.com)

ITA I tuoi guide di pittura possono essere trovate su [citadelcolour.com](http://citadelcolour.com)  
 日本語の塗料ガイドは [citadelcolour.com](http://citadelcolour.com) にあります  
 中文的塗料指南可在 [citadelcolour.com](http://citadelcolour.com) 上找到  
 韓文的塗料指南可在 [citadelcolour.com](http://citadelcolour.com) 上找到

CITADEL  
**COLOUR**

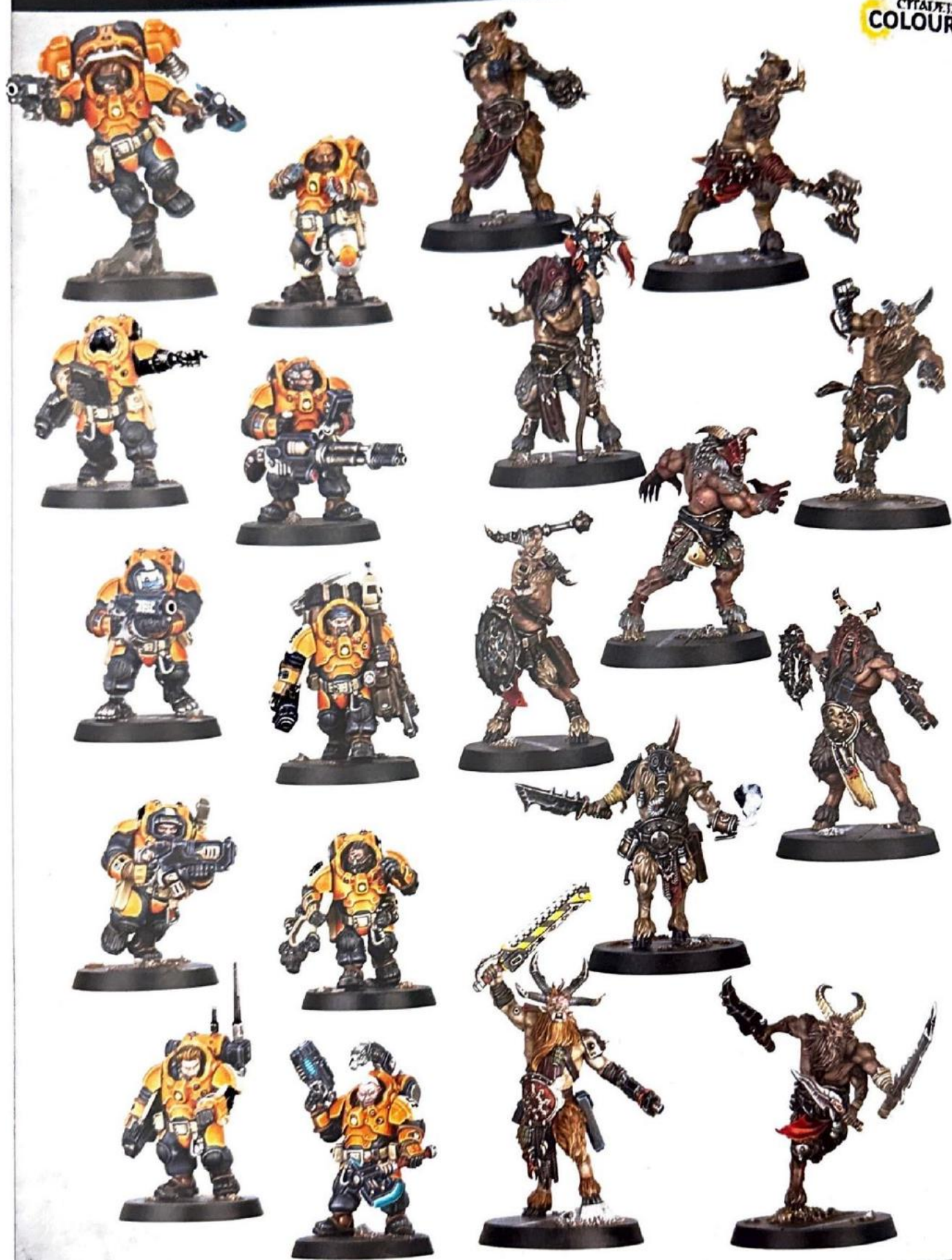

WARHAMMER.COM

Games Workshop Limited, Willow Road, Nottingham, NG7 2WS, UK  
 © Copyright Games Workshop Limited 2023.

