



Free Downloads of Build Instructions,  
Assembly Booklets & How To Guides

**BuildInstructions.com**



# WARHAMMER 40,000

## KILL RIG

KARIL' KITU | PLATAFORKMA | KILLAKUTSHE | MAKKINA AZZAZZINA | キルリグ | 杀戮战车



**!** READ THIS FIRST | À LIRE EN PRIORITÉ | BITTE BEACHT E | LEE ESTO PRIMERO | LEGGI PRIMA QUESTO | 最初にお読みください。| 请优先阅读

**ENG.** BEFORE ASSEMBLING YOUR MINIATURES, PLEASE READ THROUGH THE INSTRUCTIONS IN THIS BOOKLET CAREFULLY. A pair of plastic cutters is required to remove the plastic components in this kit from their frame. We advise using a mouldline scraping tool to clean up the parts. To assemble your model you will need plastic glue. Games Workshop sells Citadel Fine Detail Cutters, Citadel Mouldline Remover and Citadel Plastic Glue, but does not recommend these products for use by children under the age of 16 without adult supervision.

**FR.** AVANT D'ASSEMBLER VOS FIGURINES, VEUILLEZ LIRE ATTENTIVEMENT LES INSTRUCTIONS DE CE LIVRET. Une pince coupante est requise pour détacher chaque élément de sa grappe. Nous vous recommandons l'utilisation d'un grattoir pour ébarber les éléments. Pour l'assemblage, vous aurez également besoin de colle plastique. Games Workshop commercialise les Pinces de Précision Citadel, l'Ebarboir Citadel et la Colle Plastique Citadel, mais n'en recommande pas l'utilisation pour des enfants de moins de 16 ans sans la supervision d'un adulte.

**ESP.** POR FAVOR, LEE CUIDADOSAMENTE ESTE LIBRETO DE INSTRUCCIONES ANTES DE EMPEZAR A MONTAR LAS MINIATURAS. Te harán falta unas tenazas para plástico a fin de separar las piezas de la matriz. También aconsejamos una herramienta para rebabas a fin de limpiar cada pieza. Para montar la miniatura necesitarás pegamento para plástico. Games Workshop vende Tenazas Citadel. Herramientas para rebabas Citadel y Pegamento para plástico Citadel, pero no recomienda estos productos a menores de 16 años sin la supervisión de un adulto.

**GER.** VOR DEM ZUSAMMENBAU DER MINIATUREN BITTE DIE ANWEISUNGEN IN DIESER ANLEITUNG AUFMERKSAM DURCHLESEN. Du benötigst einen

Kunststoffseitenschneider, um die Kunststoffbauteile aus dem Gussrahmen herauszutrennen, und Kunststoffkleber, um die Miniatur zusammenzubauen. Außerdem empfehlen wir, die Bauteile vorher mit einem Gussgratentferner zu säubern. Games Workshop bietet Präzisions-Kunststoffseitenschneider von Citadel sowie Citadel-Kunststoffkleber an, empfiehlt aber, dass Kinder unter 16 Jahren diese nur unter Aufsicht eines Erwachsenen benutzen.

**ITA.** PRIMA DI ASSEMBLARE LE TUE MINIATURE LEGGI ATTENTAMENTE TUTTE LE ISTRUZIONI DI QUESTO LIBRETTO. Sono necessarie un paio di tronchesine per plastica per staccare i componenti dai loro sprue. Consigliamo di usare un attrezzo apposito per pulire i componenti. Per assemblare il modello avrai bisogno di colla per plastica. Games Workshop vende Tronchesine di precisione Citadel. Attrezzo per ripulire Citadel e Colla per plastica Citadel, ma non consiglia questi prodotti ad un pubblico minore di 16 anni senza la supervisione di un adulto.

**日.** 本キット内のフレームからプラスチックパーツを切り離すためには、ニッパーが必要です。パーツのモールドを平らにするには、専用ツールを使用をお勧めいたします。本キットの組み立てには、ブフ用接着剤が必要です。ゲームスワークショップはシタデル・ニッパー、ブフ用接着剤、シタデル・モールドラインリムーバーを販売しておりますが、16歳以下の子供が大人の監督なしにこれらの道具を使用されることをお勧めしません。

**+** 你需要一把模型剪将塑料部件从板上剪下来。我们建议使用分模线刮刀来处理零件。组装时你还需要用到模型胶水。你可以从 Games Workshop 处购买到 Citadel Fine Detail Cutter 模型剪、Citadel Mouldline Remover 分模线刮刀和 Citadel Plastic Glue 模型胶。但 16 岁以下儿童不得在没有成年人监护的情况下使用这些产品。



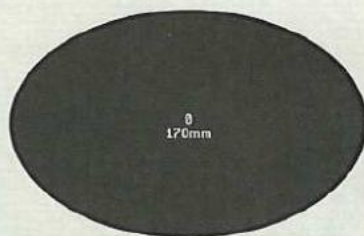

Ø  
170mm

x1



Ø  
32mm

x1

CHOOSE THE VARIANT YOU WANT TO BUILD | CHOISISSEZ LA VARIANTE À ASSEMBLER | ELIGE QUÉ VERSIÓN QUIERES MONTAR

WÄHLE DIE VARIANTE, DIE DU BAUEN MÖCHTEST | SCEGLI LA VARIANTE CHE VUOI ASSEMBLARE | 組み立てバリエーションの選択 | 选择你喜欢的拼装方式

STEPS | ÉTAPES | PASOS | SCHRITTE | FASI | ステップ | 步骤

1 - 10

## KILL RIG

KARIOL'KITU | PLATAFORKMA | KILLAKUTSCHE  
MAKKINA AZZAZZINA | キルリグ | 杀戮战车

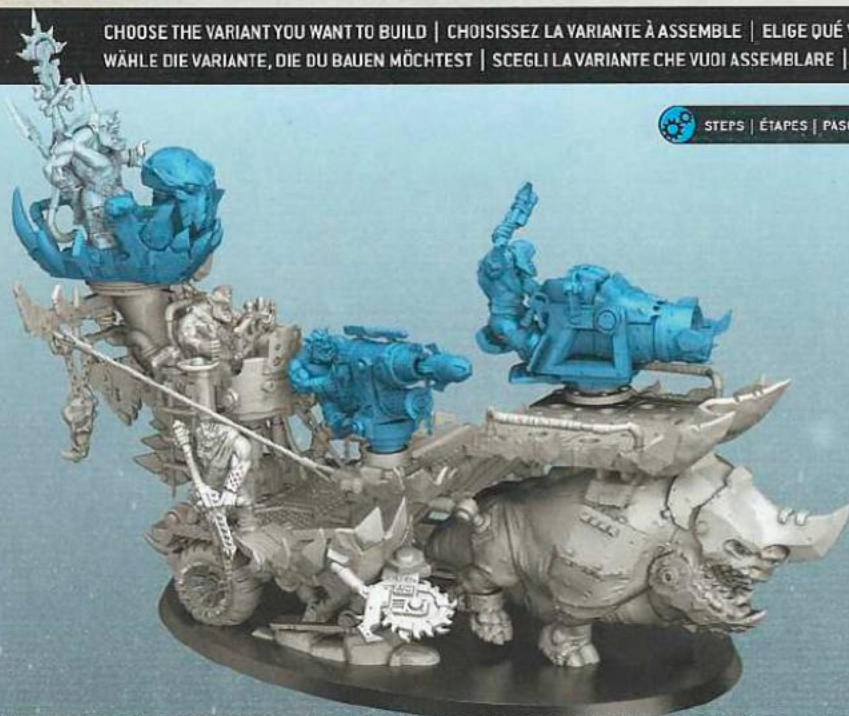

STEPS | ÉTAPES | PASOS | SCHRITTE | FASI | ステップ | 步骤

1 - 8 ; 11

## HUNTA RIG

KARIOL'KICHASS'  
CAZAFORKMA  
JAGAKUTSCHE  
MAKKINA DA KACCIA  
ハンタリグ  
狩猎战车





- ! • Special instruction - Please read
- ! • Instructions spéciales - Lire attentivement
- ! • Instrucción especial: Por favor, léela
- ! • Besondere Anweisung - Bitte lesen
- ! • Istruzioni speciali - Leggi attentamente
- ! • 特記事項 - 必ずお読みください
- ! • 特殊说明 - 请详阅

- 🔄 • Dry fit stage before gluing
- 🔄 • Tester avant de coller
- 🔄 • Comprobar el encaje antes de pegar
- 🔄 • Positionierung erst ohne Klebstoff ausprobieren
- 🔄 • Prova a secco prima di incollare
- 🔄 • 接着前にぴったり合わせること
- 🔄 • 粘着前の仮組阶段

- 🚫 • Do not glue the components
- 🚫 • Ne pas coller les éléments
- 🚫 • No pegar los componentes
- 🚫 • Bitte die Teile nicht kleben
- 🚫 • Non incollare i componenti
- 🚫 • このパーツは接着不可
- 🚫 • 请勿粘接

- 🎨 • Paint before assembly
- 🎨 • Peindre avant assemblage
- 🎨 • Pintar antes del montaje
- 🎨 • Erst bemalen, dann zusammenbauen
- 🎨 • Dipingi prima dell'assemblaggio
- 🎨 • 組み立て前にペイントすること
- 🎨 • 组装前涂装

- 🔄 • Variant assembly
- 🔄 • Variante d'assemblage
- 🔄 • Variante de montaje
- 🔄 • Bauvariante
- 🔄 • Assemblaggio alternativo
- 🔄 • 組み立てバリエーション
- 🔄 • 多种组装方式

- ✅ • Stage complete
- ✅ • Étape terminée
- ✅ • Paso completado
- ✅ • Schritt abgeschlossen
- ✅ • Fase completa
- ✅ • このステージの完成
- ✅ • 完成

1 a

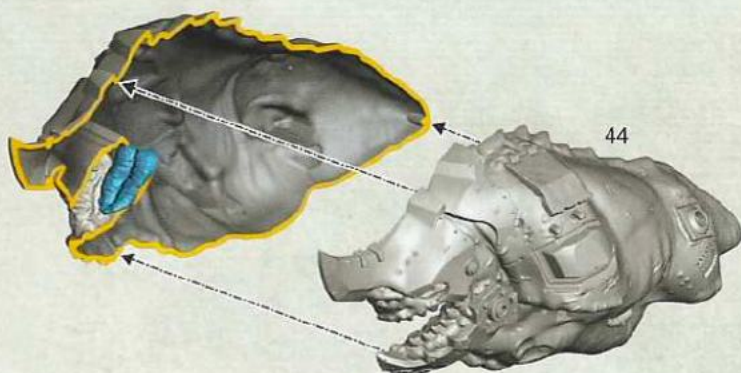
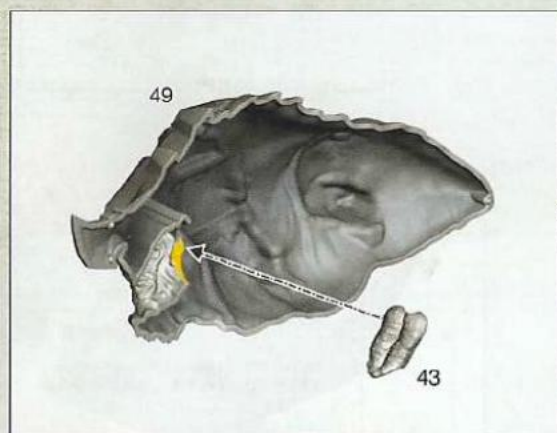

1 b

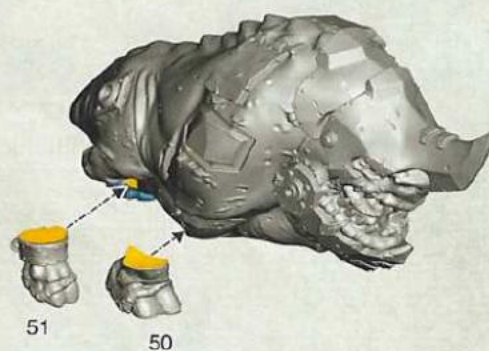
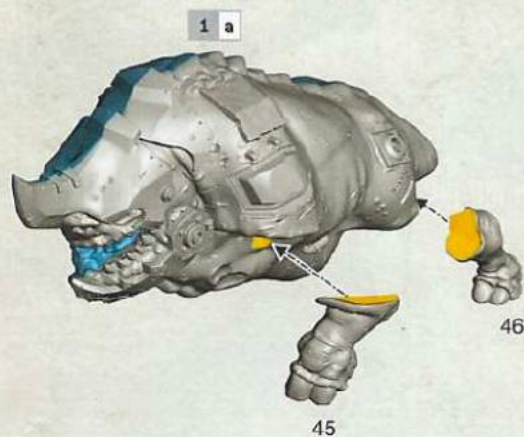

1 c

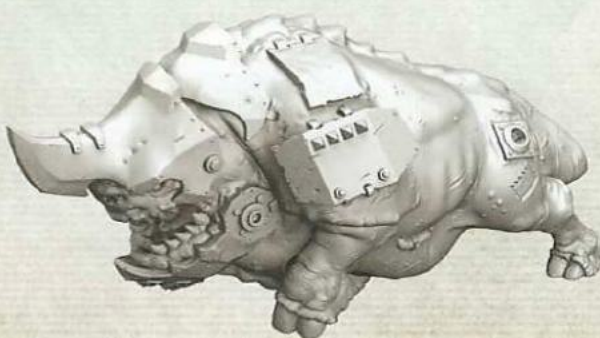
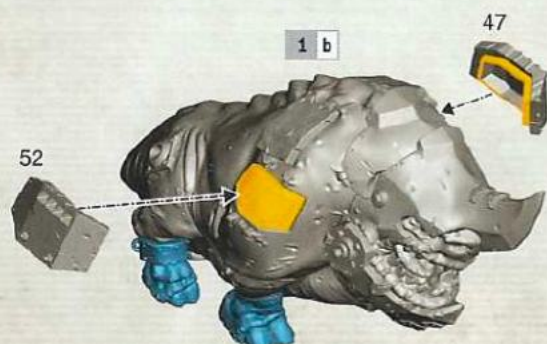



2 a

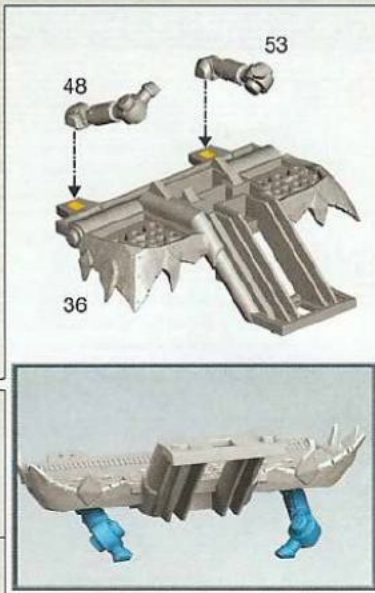
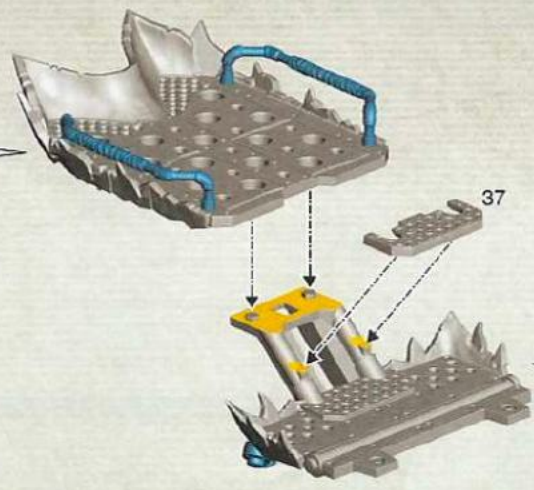
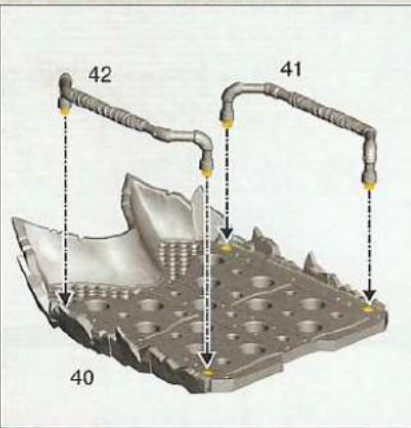

2 b

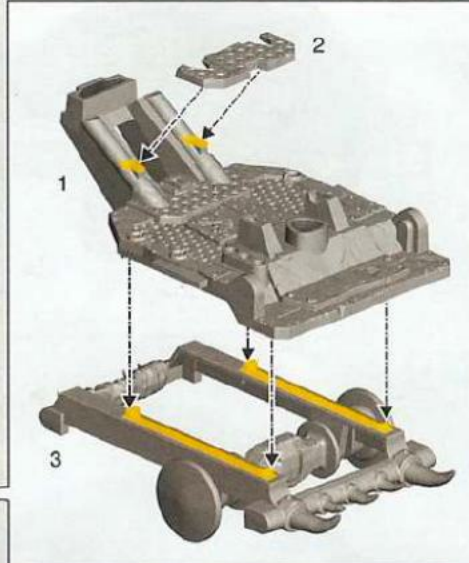
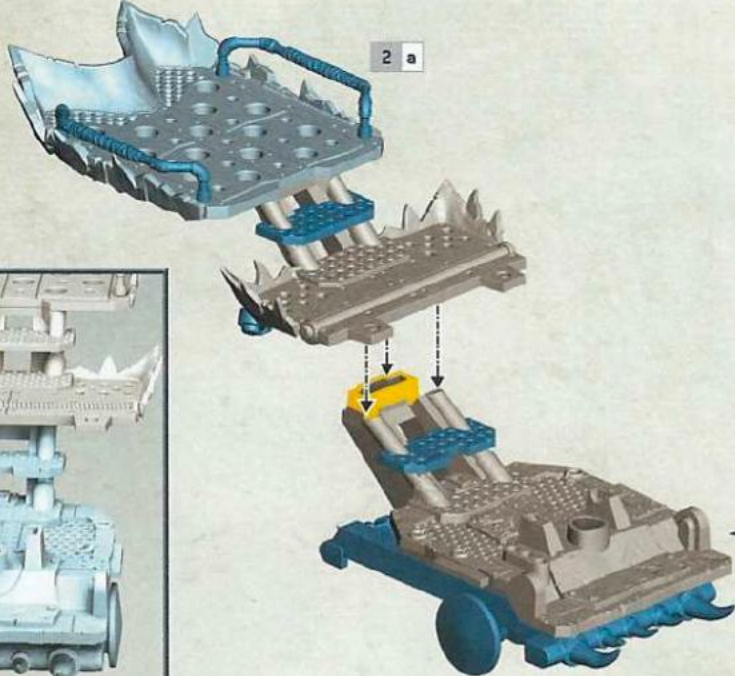

2 c

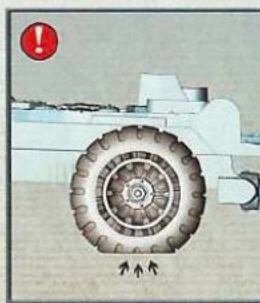
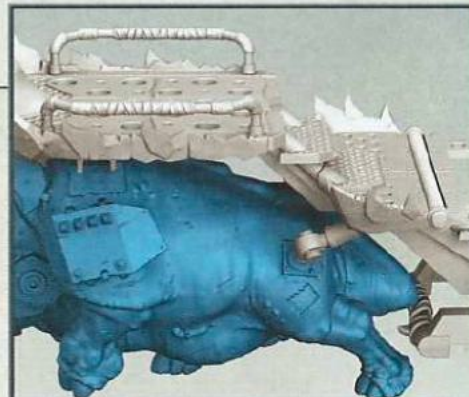
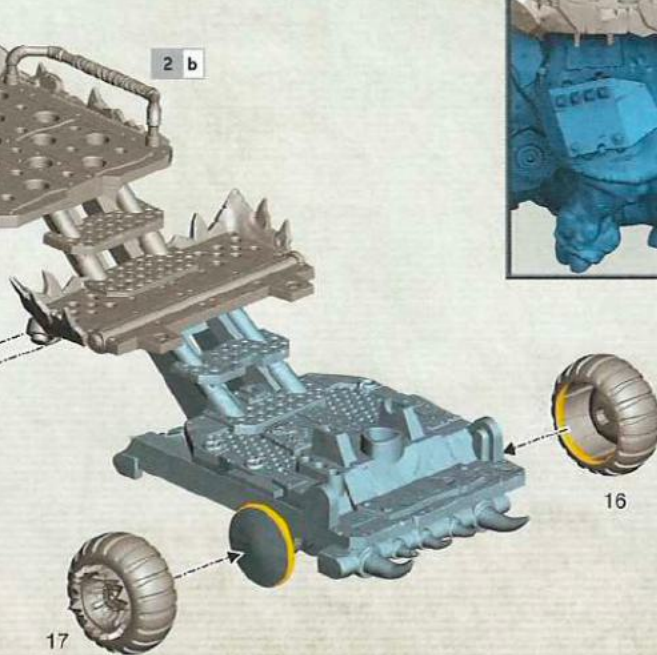
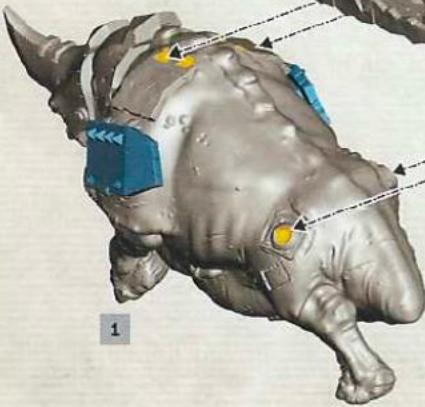



2 d



2 c

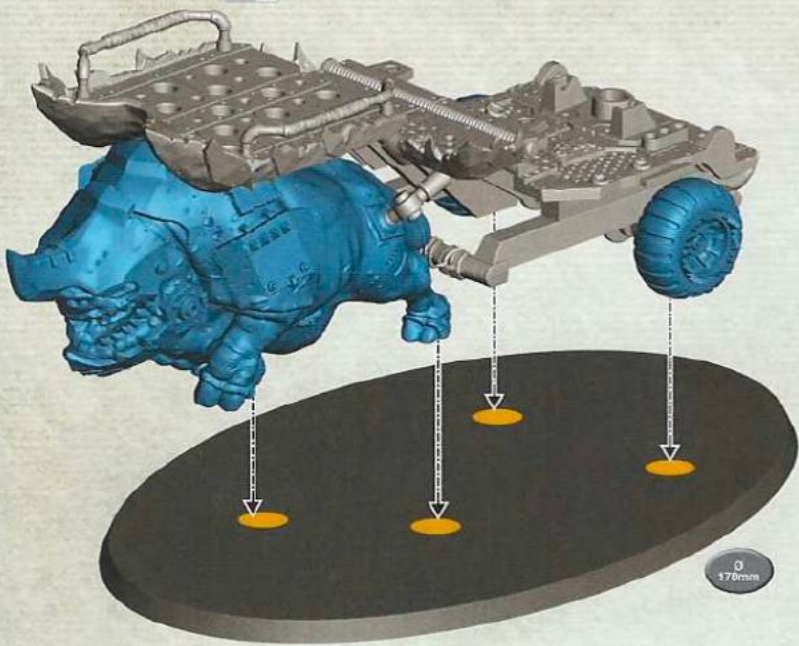

3 a

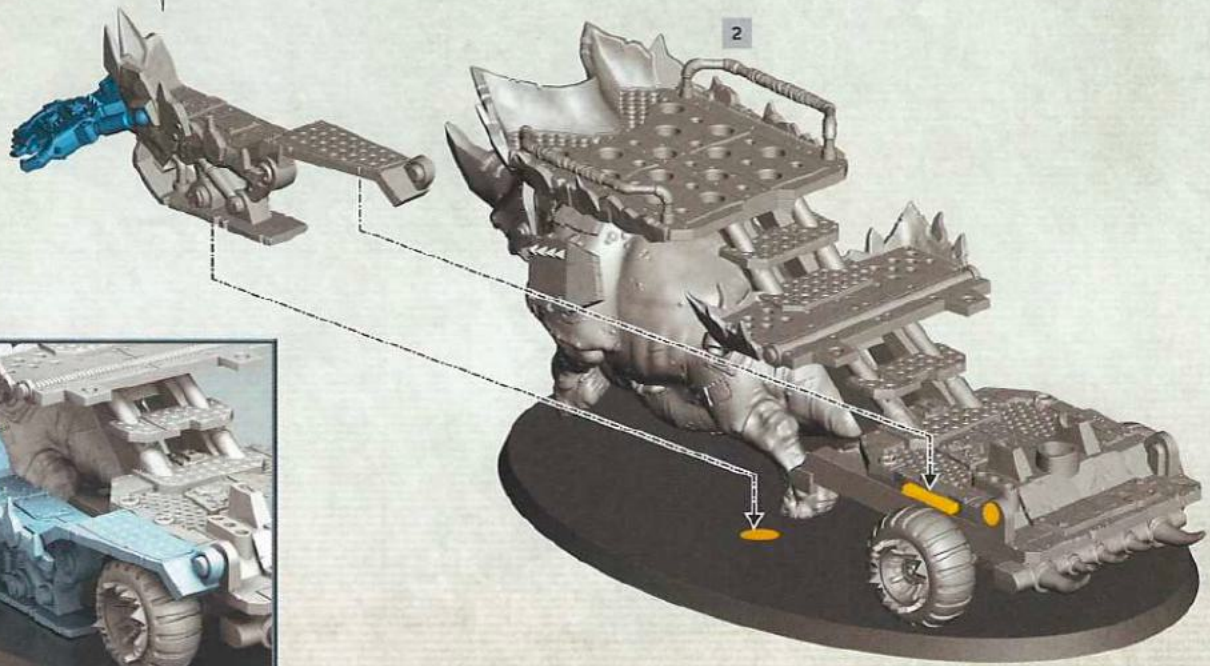
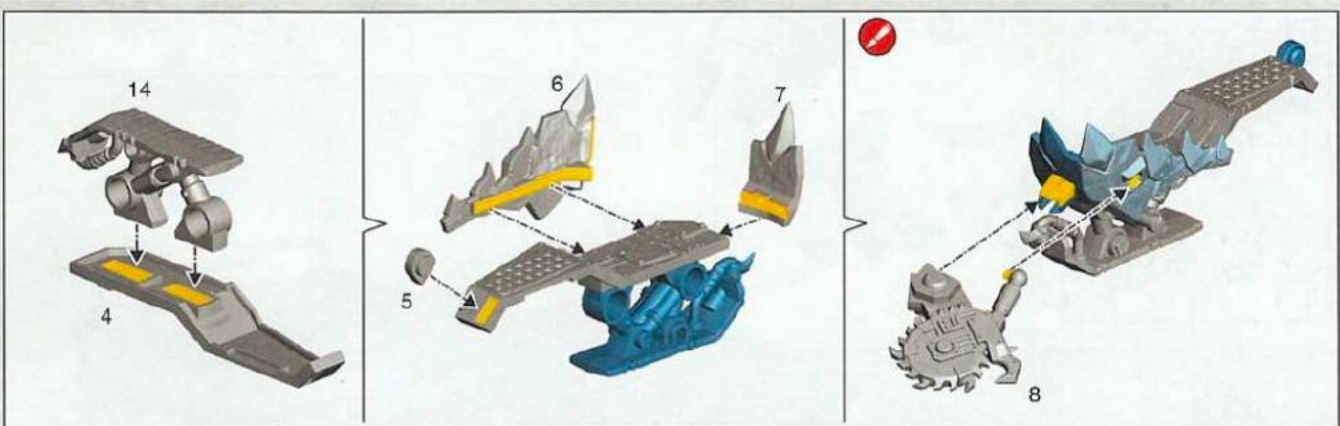



3 b

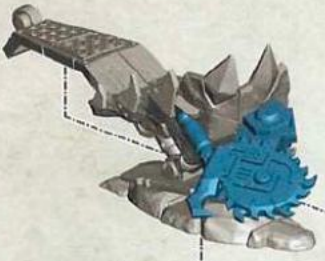
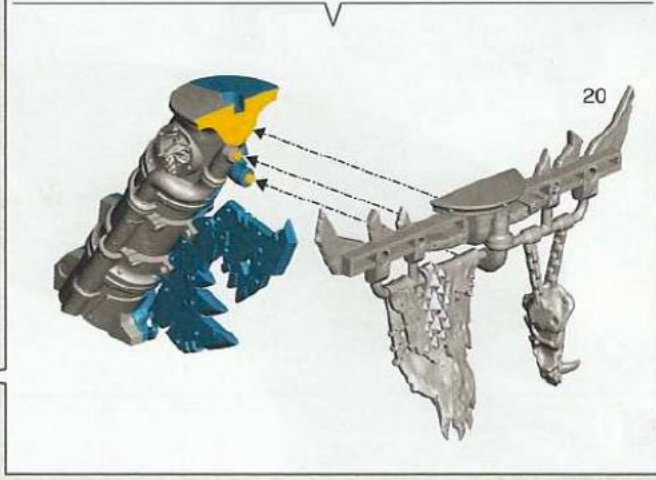
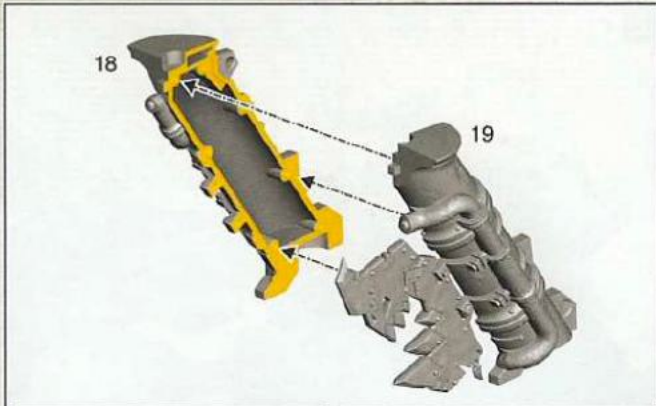

3 a

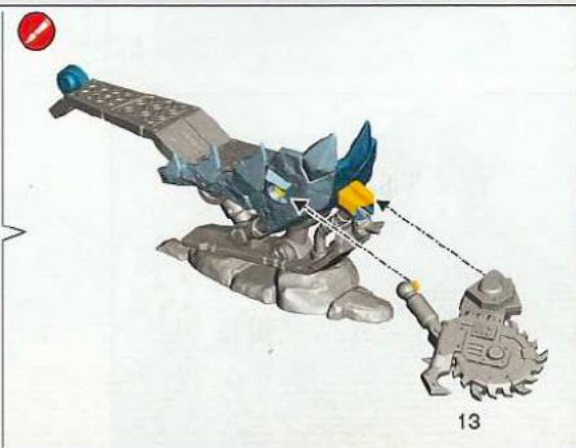
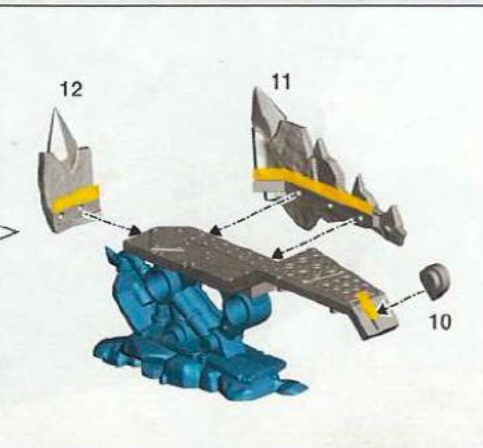
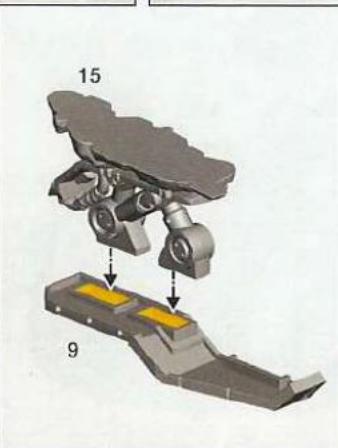
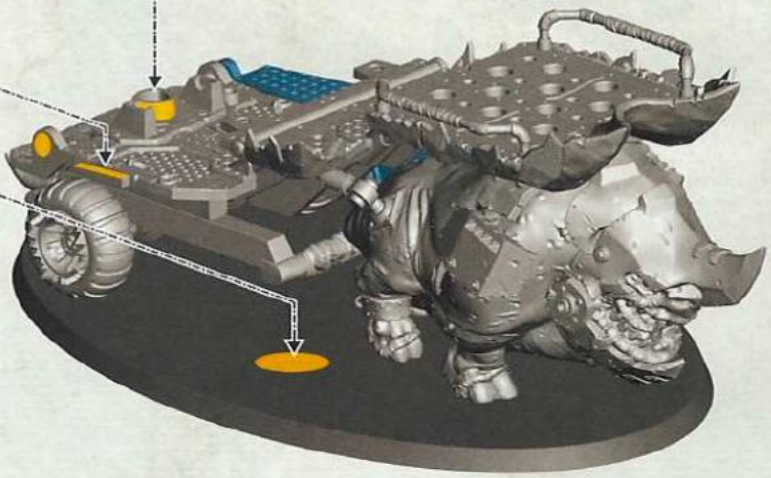





4 a

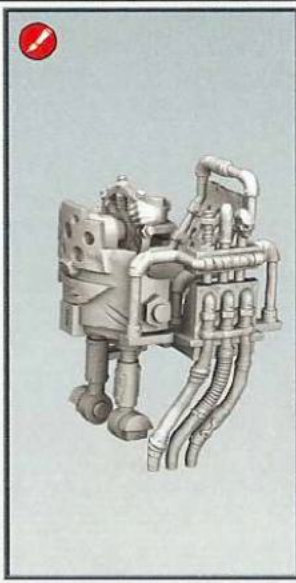
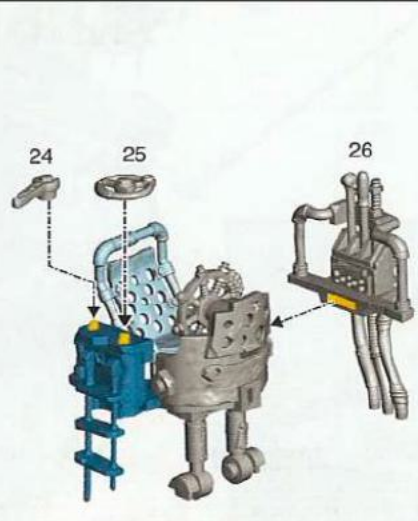
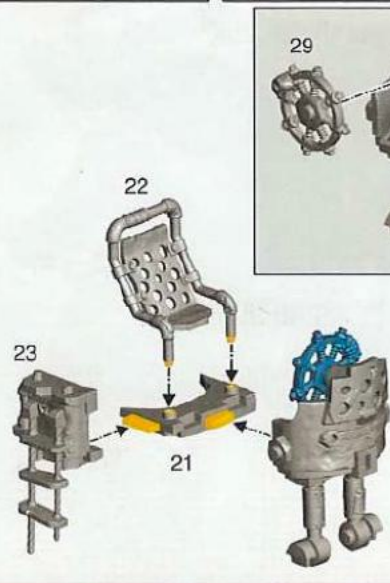
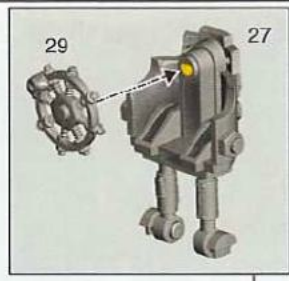
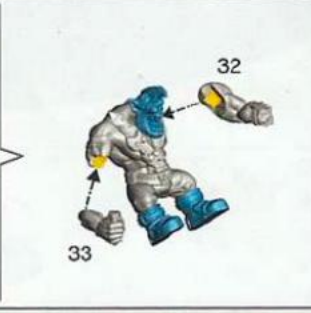
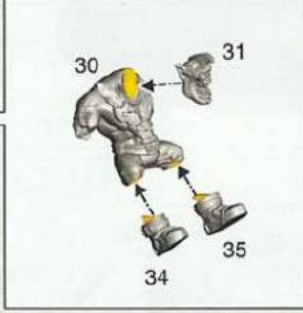
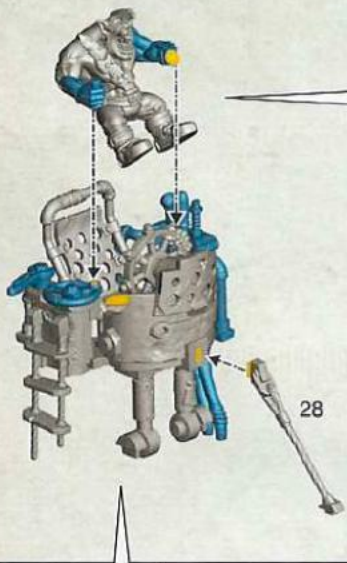



4 b 

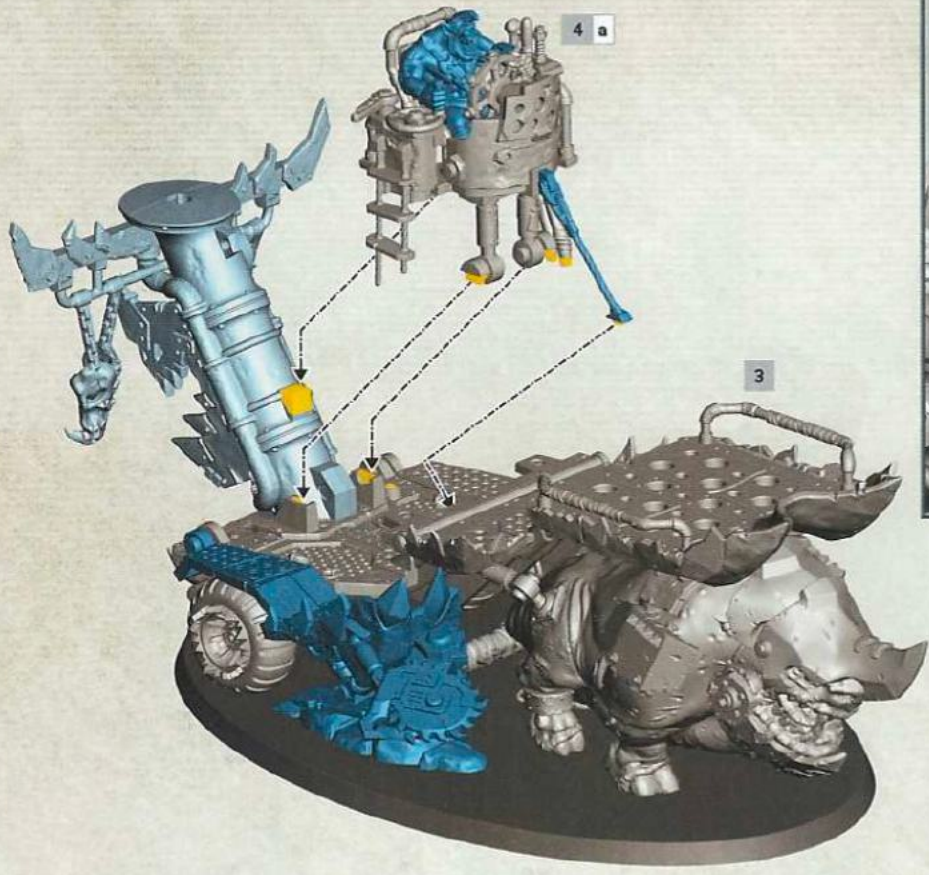

4 c 

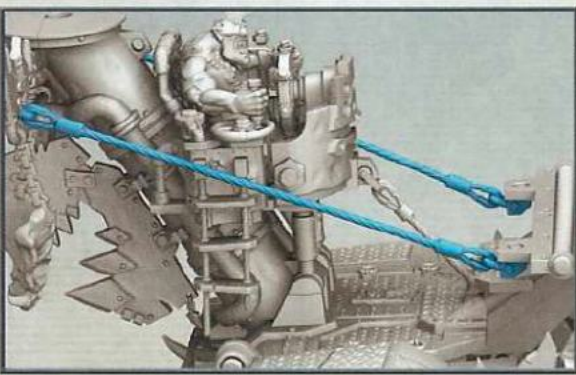
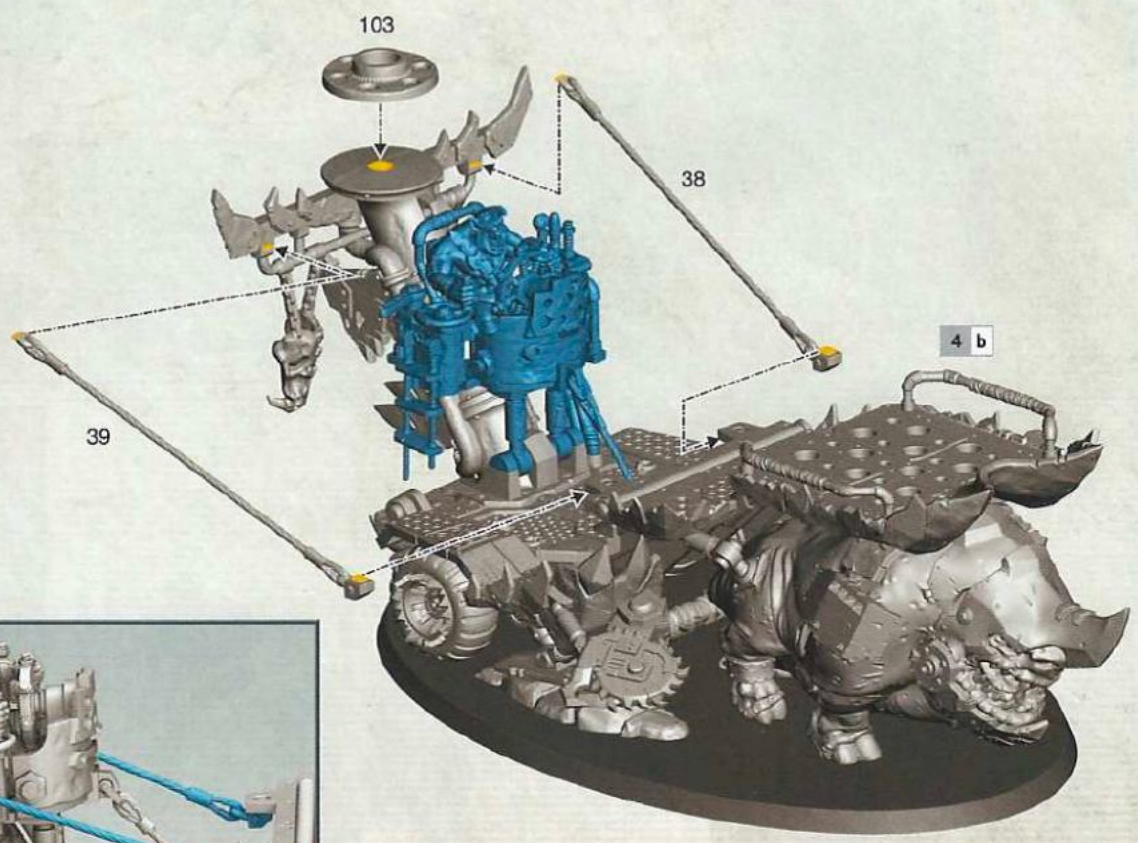





5 a

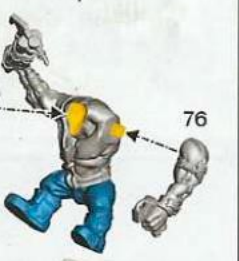
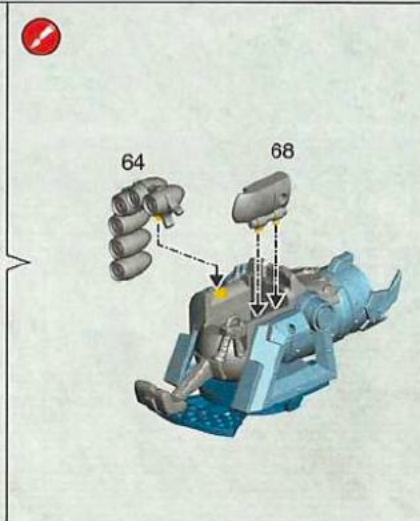
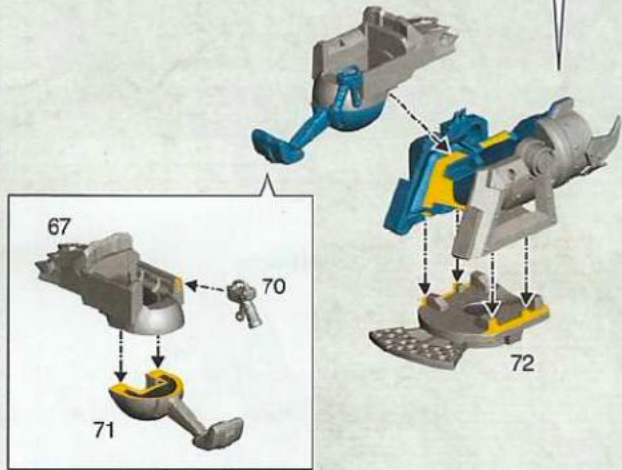
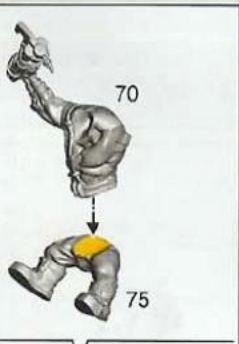
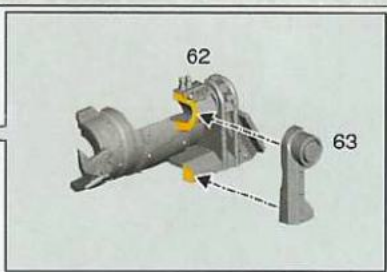
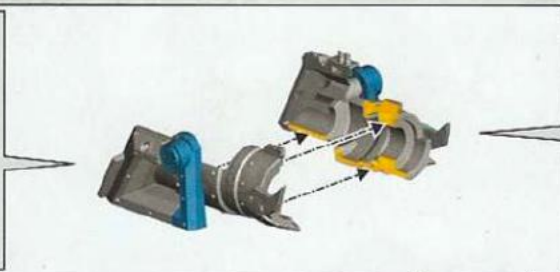
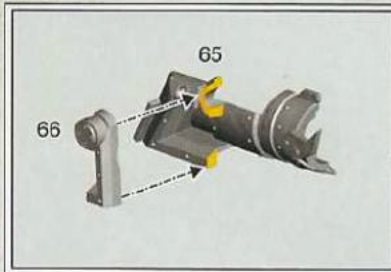

5 b

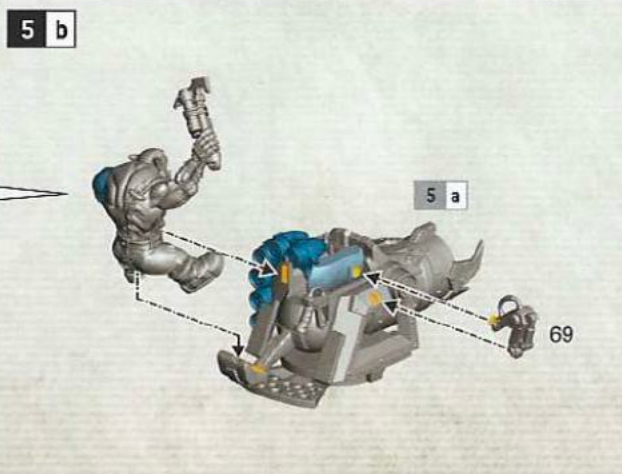



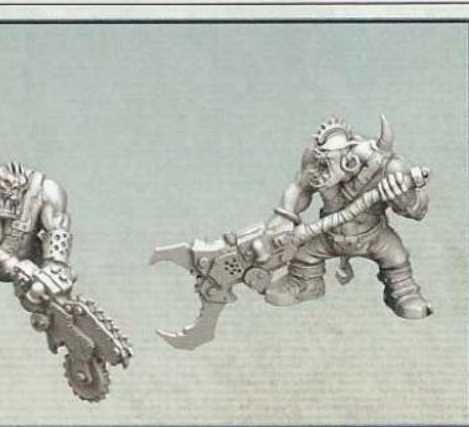
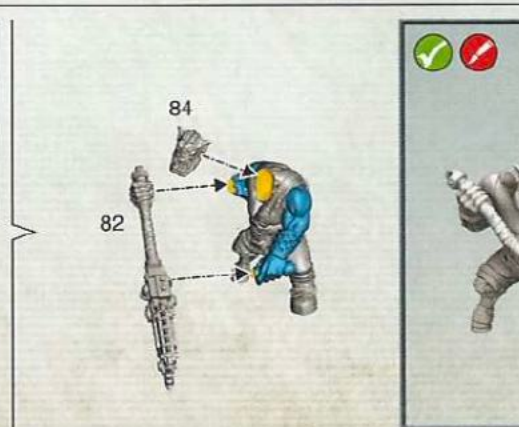
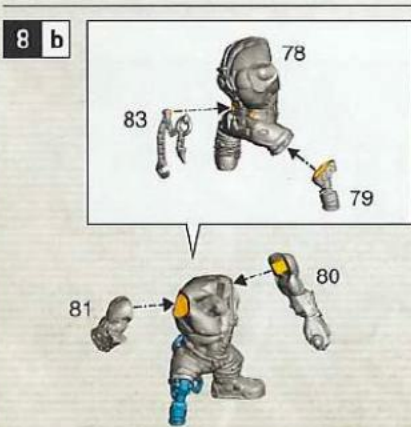
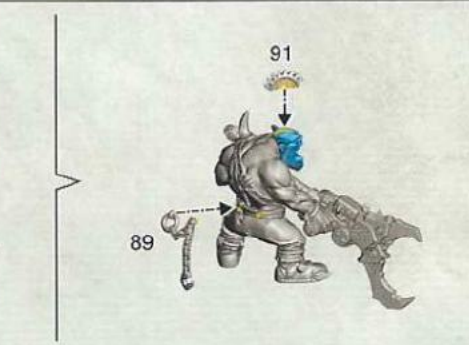
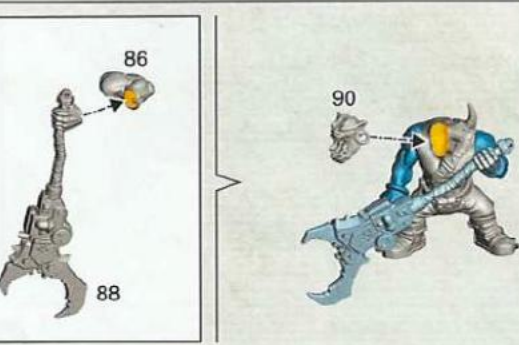
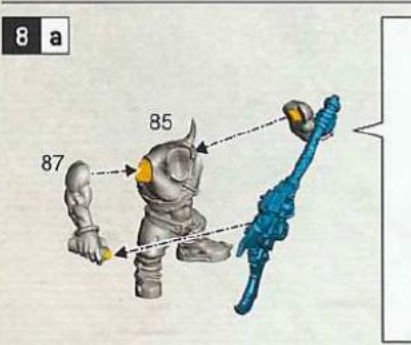
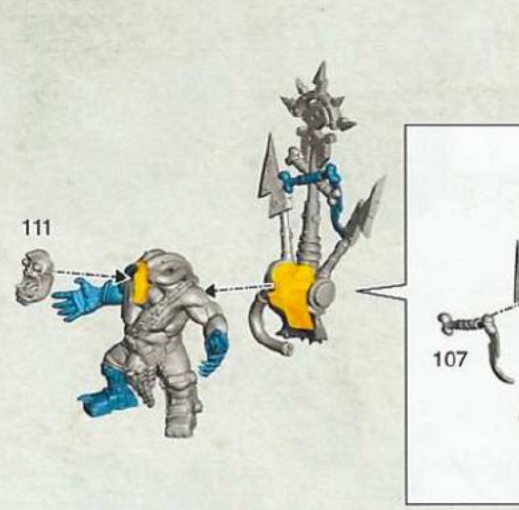
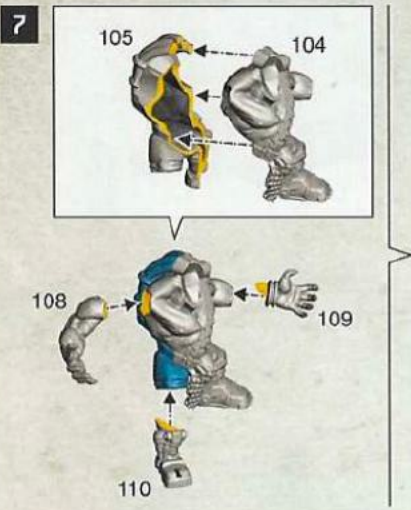
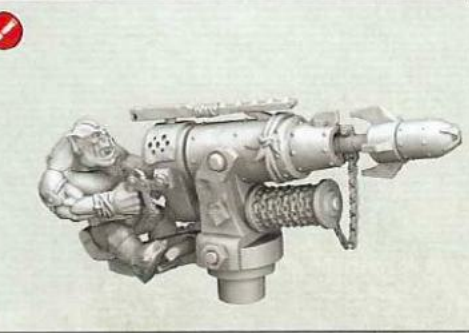
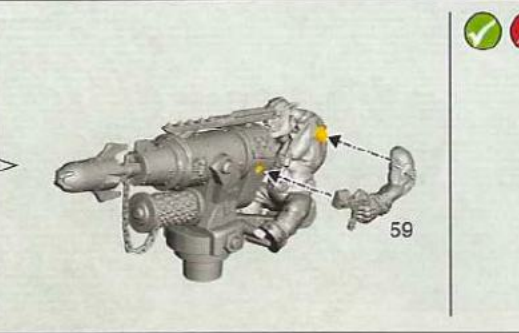
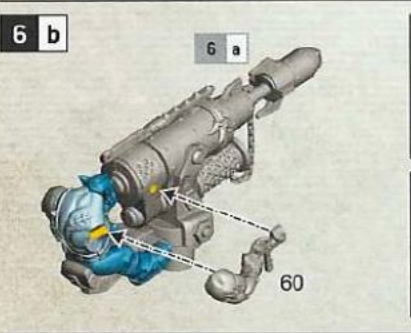
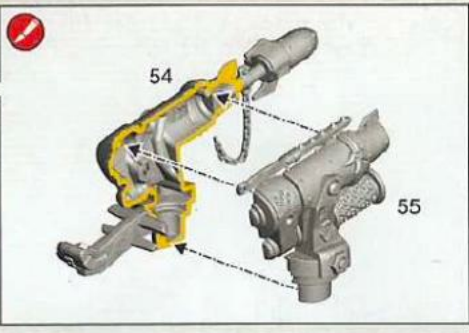
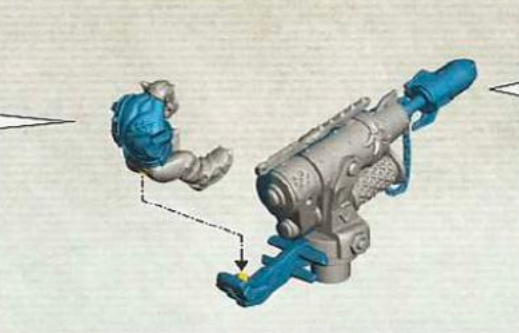
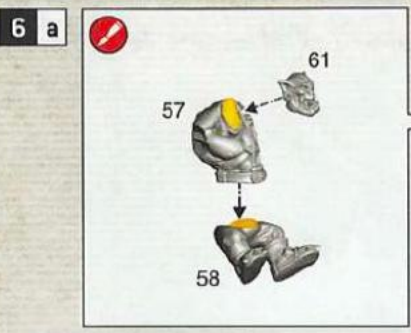





### KILL RIG

KARIOL' KITU  
 PLATAFORKMA  
 KILLAKUTSCHE  
 MAKKINA AZZAZZINA  
 キルリグ  
 杀戮战车



### HUNTA RIG

KARIOL' KICHASS'  
 CAZAFORKMA  
 JÄGAKUTSCHE  
 MAKKINA DA KACCIA  
 ハンタリグ  
 狩猎战车



STEPS | ÉTAPES | PASOS | SCHRITTE | FASI | ステップ | 步骤

9 - 10



STEPS | ÉTAPES | PASOS | SCHRITTE | FASI | ステップ | 步骤

11



9 - 10

KILL RIG

KARIOL' KITU | PLATAFORKMA | KILLAKUTSCHE | MAKKINA AZZAZZINA | キルリグ | 杀戮战车

9 a

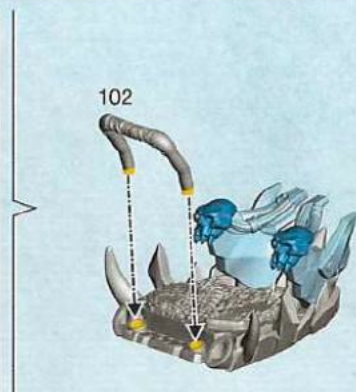
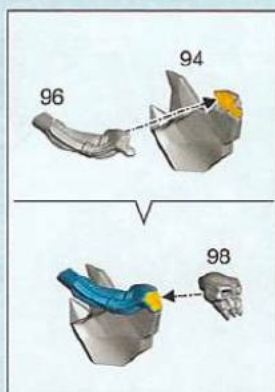
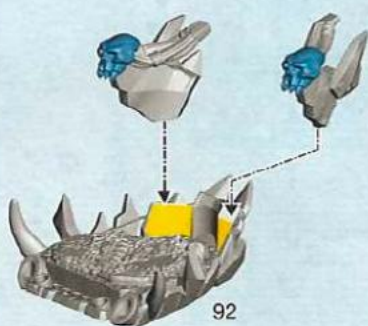
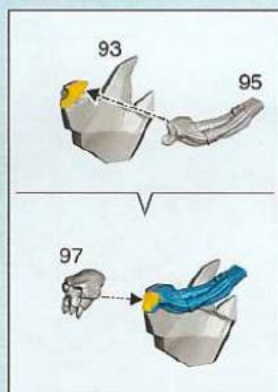

9 b

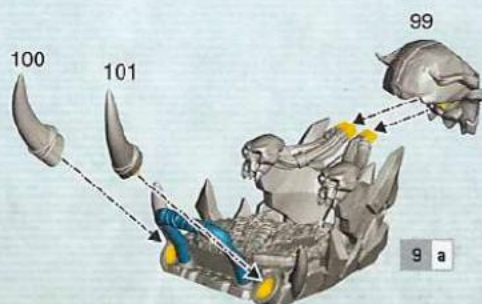



10 a 

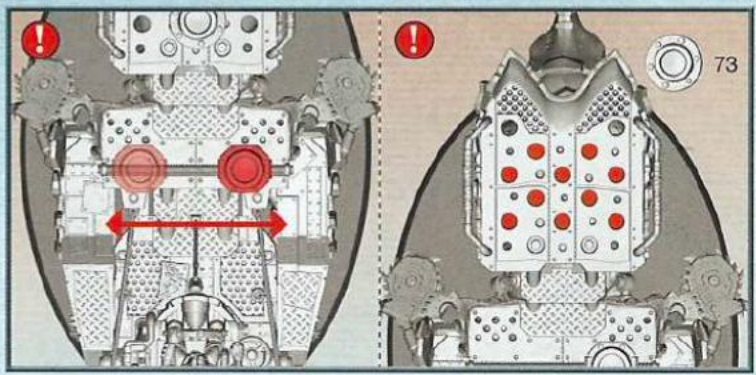
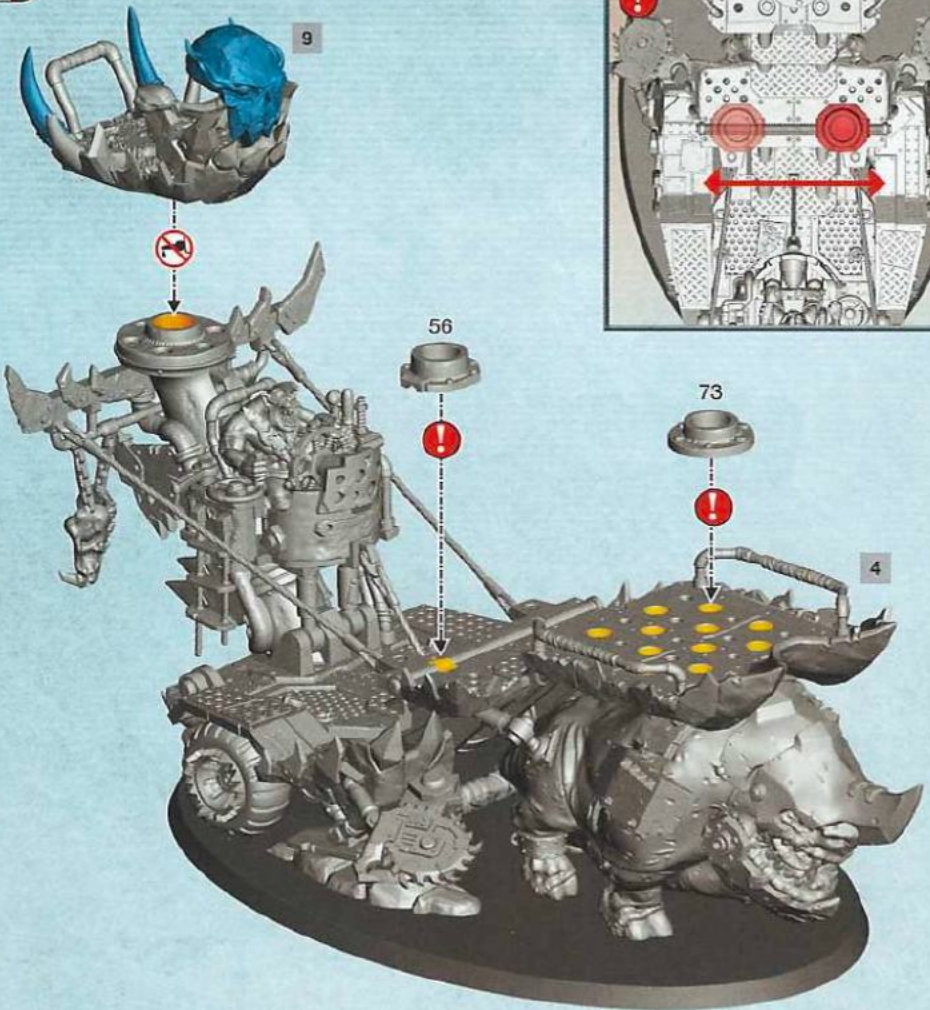

10 b









11 a

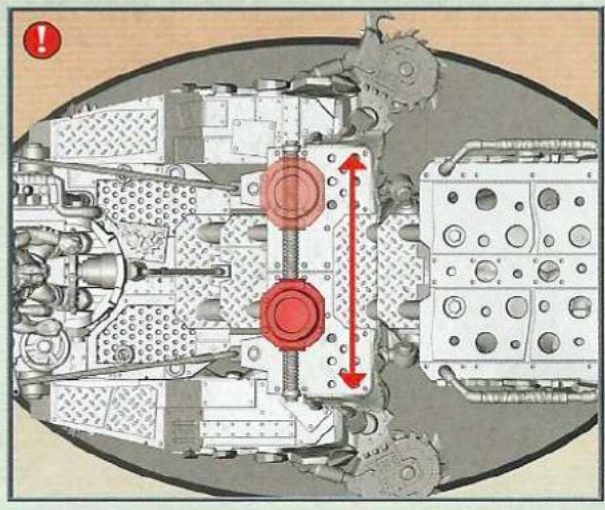
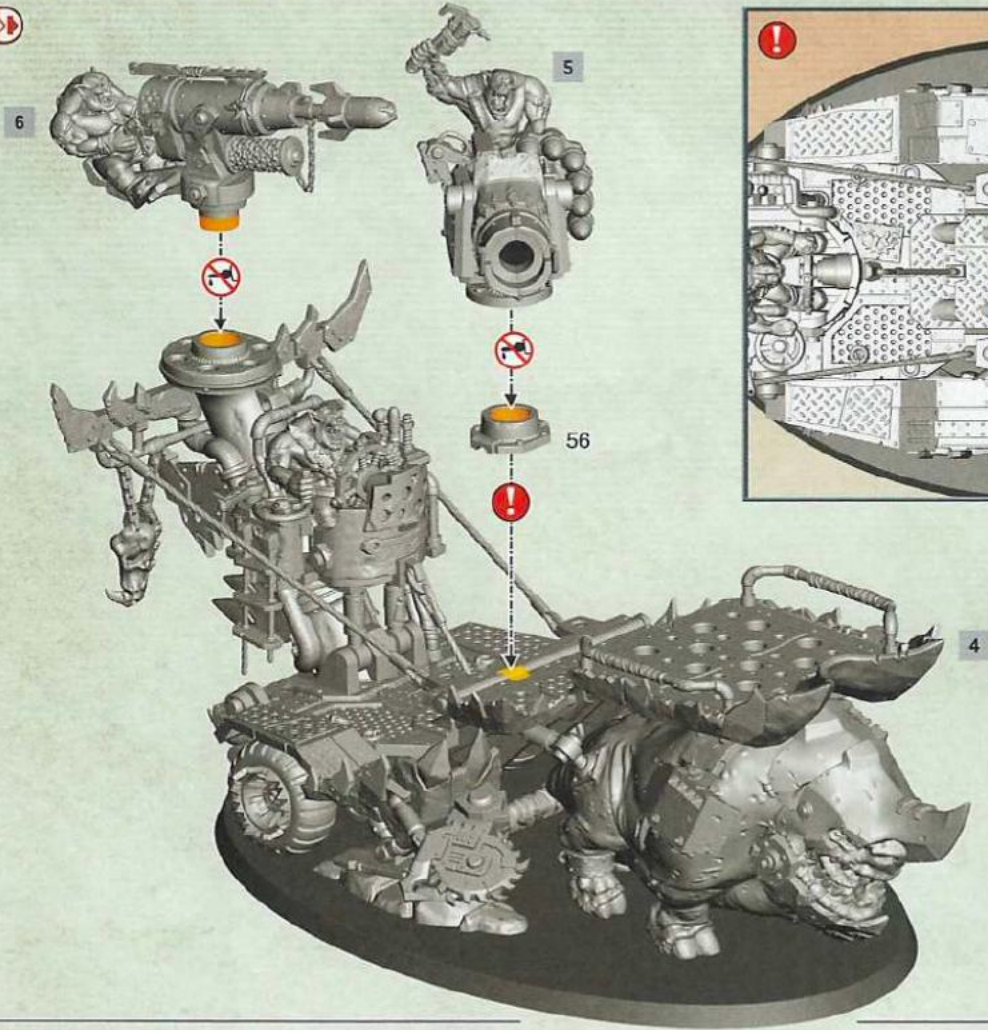

11 b







**ENG** The full painting guide can be found on [citadelcolour.com/guides](http://citadelcolour.com/guides)  
**FRE** Le guide de peinture complet est disponible sur [citadelcolour.com/guides](http://citadelcolour.com/guides)  
**ESP** Puedes encontrar la guía completa de pintura en [citadelcolour.com/guides](http://citadelcolour.com/guides)  
**GER** Die vollständige Bemalanleitung findest du auf [citadelcolour.com/guides](http://citadelcolour.com/guides)

**ITA** Puoi trovare la guida completa alla pittura su [citadelcolour.com/guides](http://citadelcolour.com/guides)  
**日本語** ペイントの完全版ガイドは [citadelcolour.com](http://citadelcolour.com) に掲載されている。  
**中文** 可以在 [citadelcolour.com/guides](http://citadelcolour.com/guides) 找到完整涂装指南。







**ENG** Used alongside the core rules found on warhammer40000.com, the essential rules below will get you up and running with your new unit on the battlefield. For the full rules for this unit, see the Codex relevant to your army.

**FRE** Utilisées avec les règles de base de warhammer40000.com les règles essentielles ci-dessous vous permettront de jouer votre nouvelle unité sur le champ de bataille. Pour les règles complètes de cette unité, référez-vous au Codex correspondant à votre armée.

**ESP** Usadas junto a las reglas básicas que encontrarás en warhammer40000.com, las siguientes reglas esenciales pondrán tu nueva unidad en el campo de batalla. Para ver las reglas completas de esta unidad, consulta el Codex de tu ejército.

**GER** Wenn du die Regeln unten zusammen mit den Grundregeln auf warhammer40000.com verwendest, kannst du deine Einheit direkt auf das Schlachtfeld führen. Die vollständigen Regeln für diese Einheit findest du im entsprechenden Codex für deine Armee.

**ITA** Usate assieme alle regole base che puoi trovare su warhammer40000.com, le regole essenziali in basso ti aiuteranno a portare sul campo di battaglia la tua nuova unità. Per le regole complete di questa unità, consulta il Codex corrispondente alla tua armata.

**JPN** warhammer40000.com に掲載されているコアルールとともに以下のユニット用基本ルールを使用することで、このユニットを戦場に配備することができます。このユニットの完全版ルールについては、このユニットが属するアーミーのコーデックスを参照してください。

**CHN** 下方的基本规则需搭配 warhammer40000.com 上的《核心规则》使用，可助您将新单位部署到战场上。有关该单位的完整规则，请参见与您军队相关的《圣典》。

## KILL RIG | KARIOL'KITU | PLATAFORMMA | KILLAKUTSCHE | MAKKINA AZZAZZINA | キルリグ | 杀戮战车

Kill Rig (9+	12"	3+	5+	6	8	16	6	7	3+
Kill Rig (5-8	9"	3+	5+	5	8	N/A	D6	7	3+
Kill Rig (1-4	6"	3+	5+	4	8	N/A	D3	7	3+

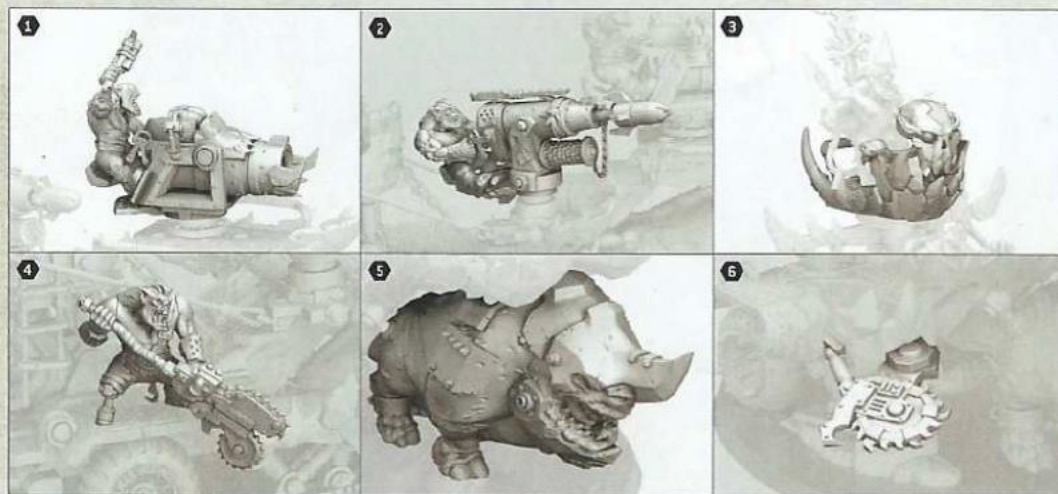

1	48"		D6	6 -1 2
2	12"		1	8 -2 3
3	24"		1	9 -3 D6
4			5	-1 1
5			+1	-2 3
6			+2	-2 2

## HUNTA RIG | KARIOL'KICHASS' | CAZAFORKMA | JÁGAKUTSCHE | MAKKINA DA KACCIA | ハンタリグ | 狩猎战车

Hunta Rig (9+	12"	3+	5+	6	8	16	6	7	3+
Hunta Rig (5-8	9"	3+	5+	5	8	N/A	D6	7	3+
Hunta Rig (1-4	6"	3+	5+	4	8	N/A	D3	7	3+

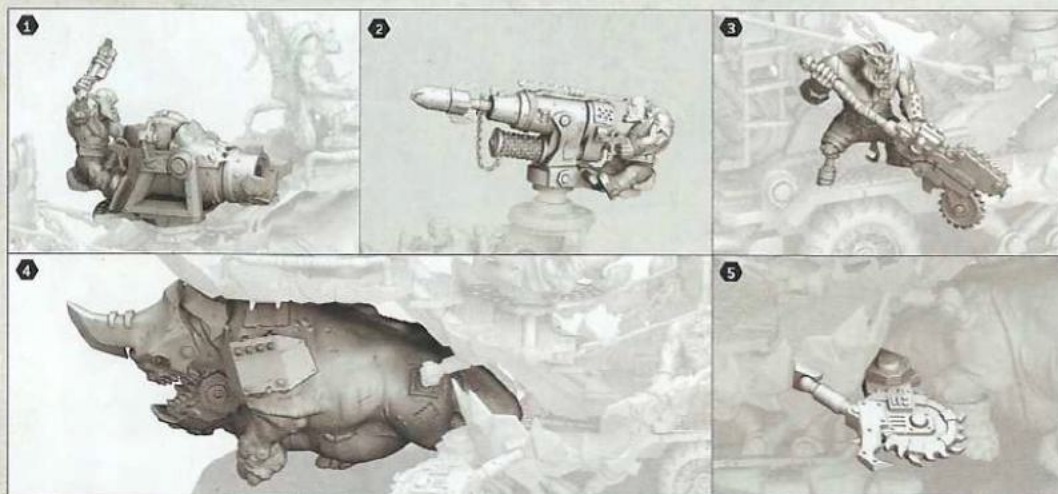

1	48"		D6	6 -1 2
2	12"		1	8 -2 3
3			5	-1 1
4			+1	-2 3
5			+2	-2 2

## WURRBOY | ZARBËY | BEZTIAMBÓTIKO | WURRIGT | TIPO ZTRAMBO | ウールボーイ | 战争小子

Wurrboy	5"	3+	5+	5	5	5	3	6	6+

1	12"		2	6 -3 D3
---	-----	--	---	---------

