

Free Downloads of Build Instructions,  
Assembly Booklets & How To Guides

**BuildInstructions.com**

**WARHAMMER**

**40,000**

# JUNITH ERUITA





• READ THIS FIRST • À LIRE EN PREMIER • LEER ANTES DE MONTAR  
• LIES DIES ZUERST • LEGGI PRIMA QUESTO

- **BEFORE ASSEMBLING YOUR MINIATURES, PLEASE READ THROUGH THE INSTRUCTIONS IN THIS BOOKLET CAREFULLY.** A pair of plastic cutters is required to remove the plastic components in this kit from their frame. We advise using a mouldline scraping tool to clean up the parts. To assemble your model you will need plastic glue. Games Workshop sells Citadel Fine Detail Cutters, Citadel Mouldline Remover and Citadel Plastic Glue, but does not recommend these products for use by children under the age of 16 without adult supervision.
- **AVANT D'ASSEMBLER VOS FIGURINES, VEUILLEZ LIRE ATTENTIVEMENT LES INSTRUCTIONS DE CE LIVRET.** Une pince coupante est requise pour détacher chaque élément de sa grappe. Nous vous recommandons l'utilisation d'un grattoir pour ébarber les éléments. Pour l'assemblage, vous aurez également besoin de colle plastique. Games Workshop commercialise les Pinces de Précision Citadel, l'Ébarboir Citadel et la Colle Plastique Citadel, mais n'en recommande pas l'utilisation pour des enfants de moins de 16 ans sans la supervision d'un adulte.
- **POR FAVOR, LEE CUIDADOSAMENTE ESTE LIBRETO DE INSTRUCCIONES ANTES DE EMPEZAR A MONTAR LAS MINIATURAS.** Te harán falta unas tenazas para plástico a fin de separar las piezas de la matriz. También aconsejamos una herramienta para rebabas a fin de limpiar cada pieza. Para montar la miniatura necesitarás pegamento para plástico. Games Workshop vende Tenazas Citadel, Herramientas para rebabas Citadel y Pegamento para plástico Citadel, pero no recomienda estos productos a menores de 16 años sin la supervisión de un adulto.
- **VOR DEM ZUSAMMENBAU DER MINIATUREN BITTE DIE ANWEISUNGEN IN DIESER ANLEITUNG AUFMERKSAM DURCHLESEN.** Du benötigst einen Kunststoffseitenschneider, um die Kunststoffbauteile aus dem Gussrahmen herauszutrennen, und Kunststoffkleber, um die Miniatur zusammenzubauen. Außerdem empfehlen wir, die Bauteile vorher mit einem Gussgratentferner zu säubern. Games Workshop bietet Präzisions-Kunststoffseitenschneider von Citadel sowie Citadel-Kunststoffkleber an, empfiehlt aber, dass Kinder unter 16 Jahren diese nur unter Aufsicht eines Erwachsenen benutzen.
- **PRIMA DI ASSEMBLARE LE TUE MINIATURE LEGGI ATTENTAMENTE TUTTE LE ISTRUZIONI DI QUESTO LIBRETTO.** Sono necessarie un paio di tronchesine per plastica per staccare i componenti dai loro sprue. Consigliamo di usare un attrezzo apposito per pulire i componenti. Per assemblare il modello avrai bisogno di colla per plastica. Games Workshop vende Tronchesine di precisione Citadel, Attrezzo per ripulire Citadel e Colla per plastica Citadel, ma non consiglia questi prodotti ad un pubblico minore di 16 anni senza la supervisione di un adulto.

• EXPLANATION OF SYMBOLS • EXPLICATION DES SYMBOLES • EXPLICACIÓN DE SÍMBOLOS  
• ERLÄUTERUNG DER SYMBOLE • LEGENDA DEI SIMBOLI



- Choice of parts
- Choix d'éléments
- Modelos de componentes
- Auswahl an Teilen
- Scelta di componenti



- Special instruction - Please read
- Instructions spéciales - Lire attentivement
- Instrucción especial: Por favor, léela
- Besondere Anweisung - Bitte lesen
- Istruzioni speciali - Leggi attentamente



- Stage complete
- Étape terminée
- Paso completado
- Schritt abgeschlossen
- Fase completa

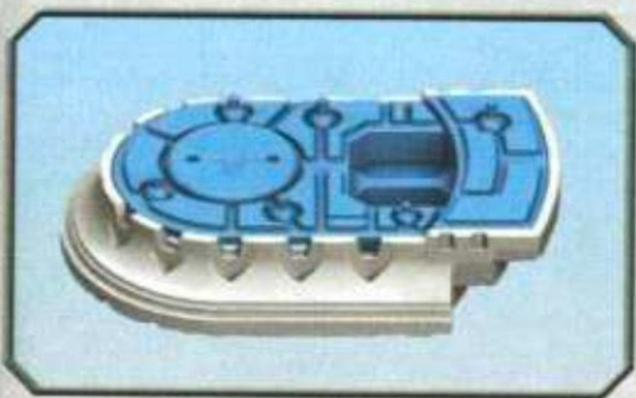
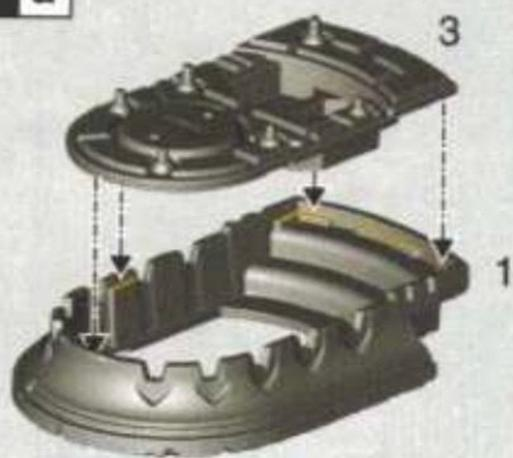
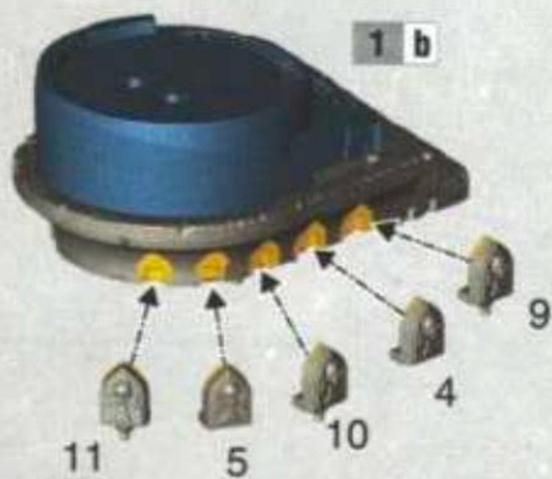
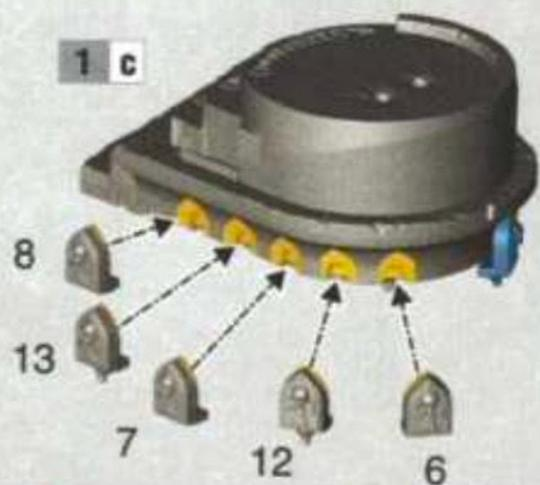

- Dry fit stage before gluing
- Tester avant de coller
- Comprobar el encaje antes de pegar
- Positionierung erst ohne Klebstoff ausprobieren
- Prova a secco prima di incollare

**1 a****1 b****1 c****1 d**

2

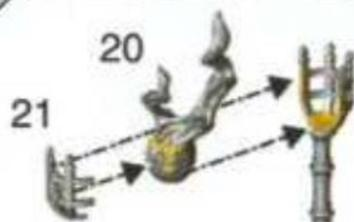
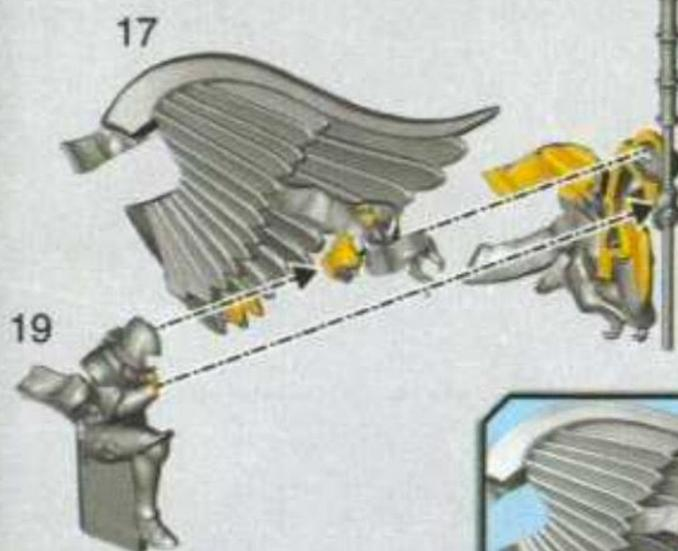

3

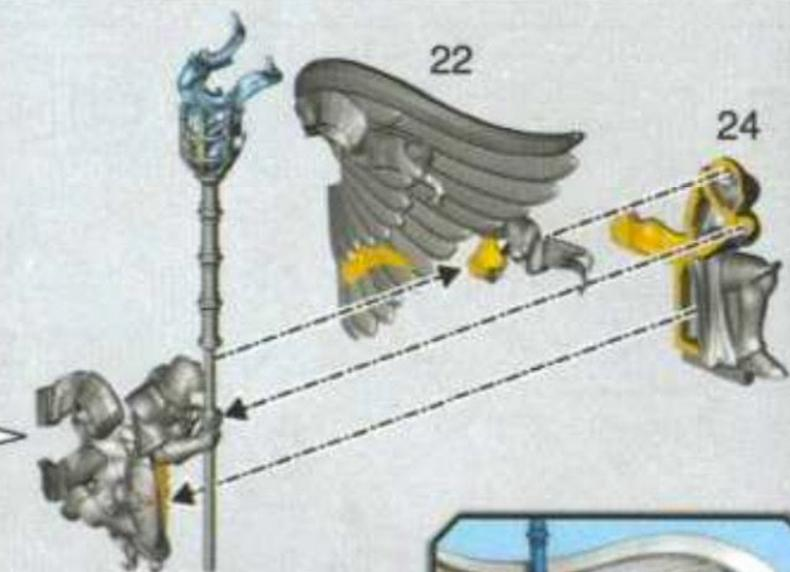
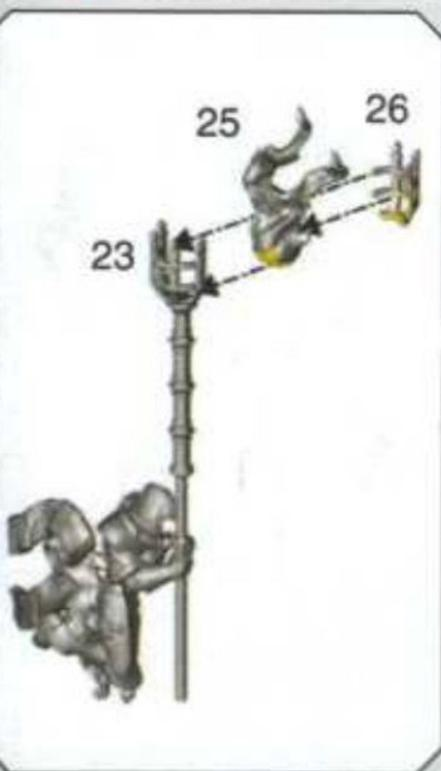

**4 a****4 b****5**

**6 a**

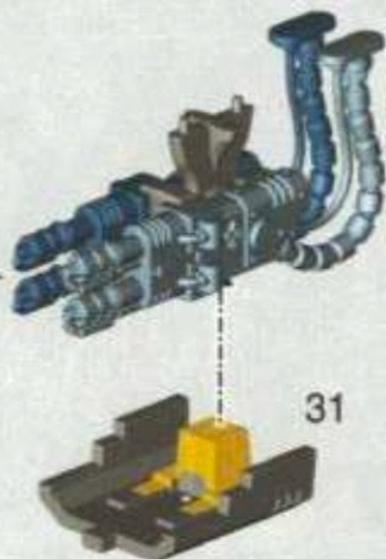
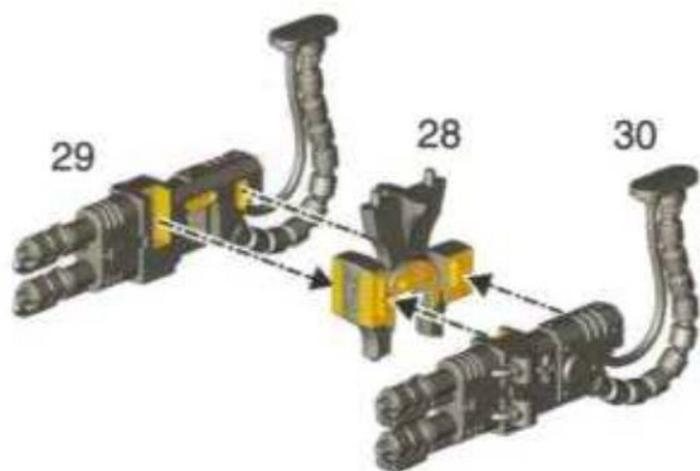

**6 b**

**6 a**

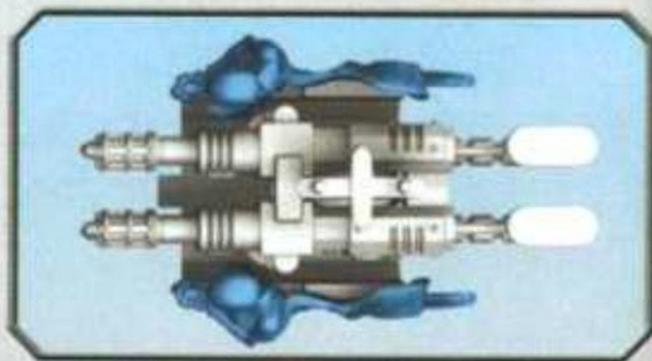
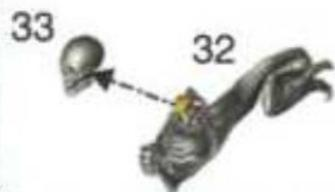
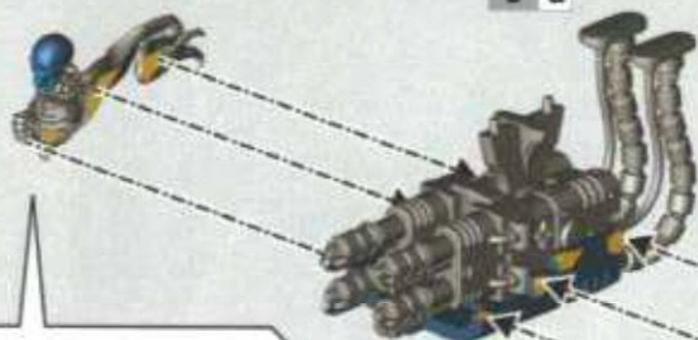

7 a



7 b

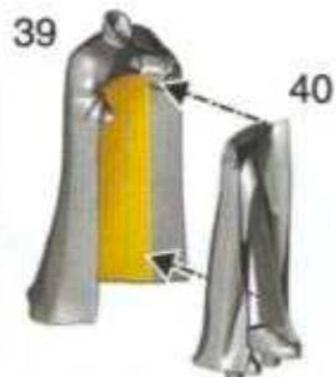
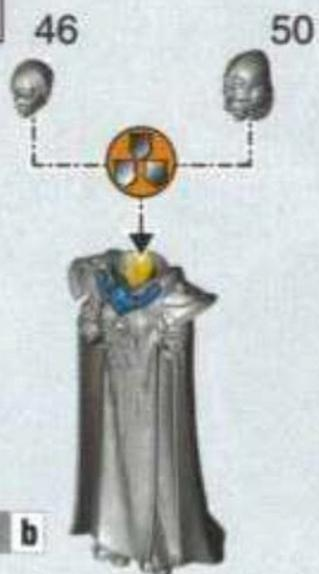

**8 a****8 b****8 c****8 d****8 e**

9 a



7 b



9 b

9 a

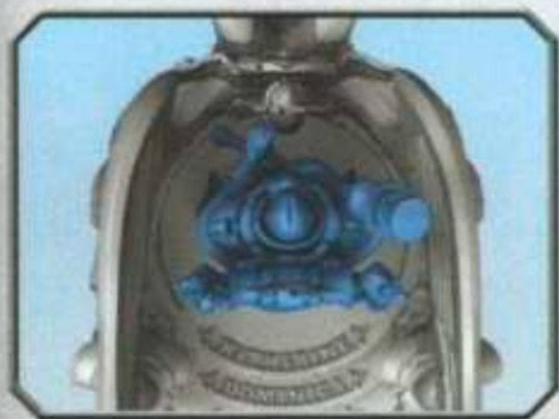

9 c

9 b

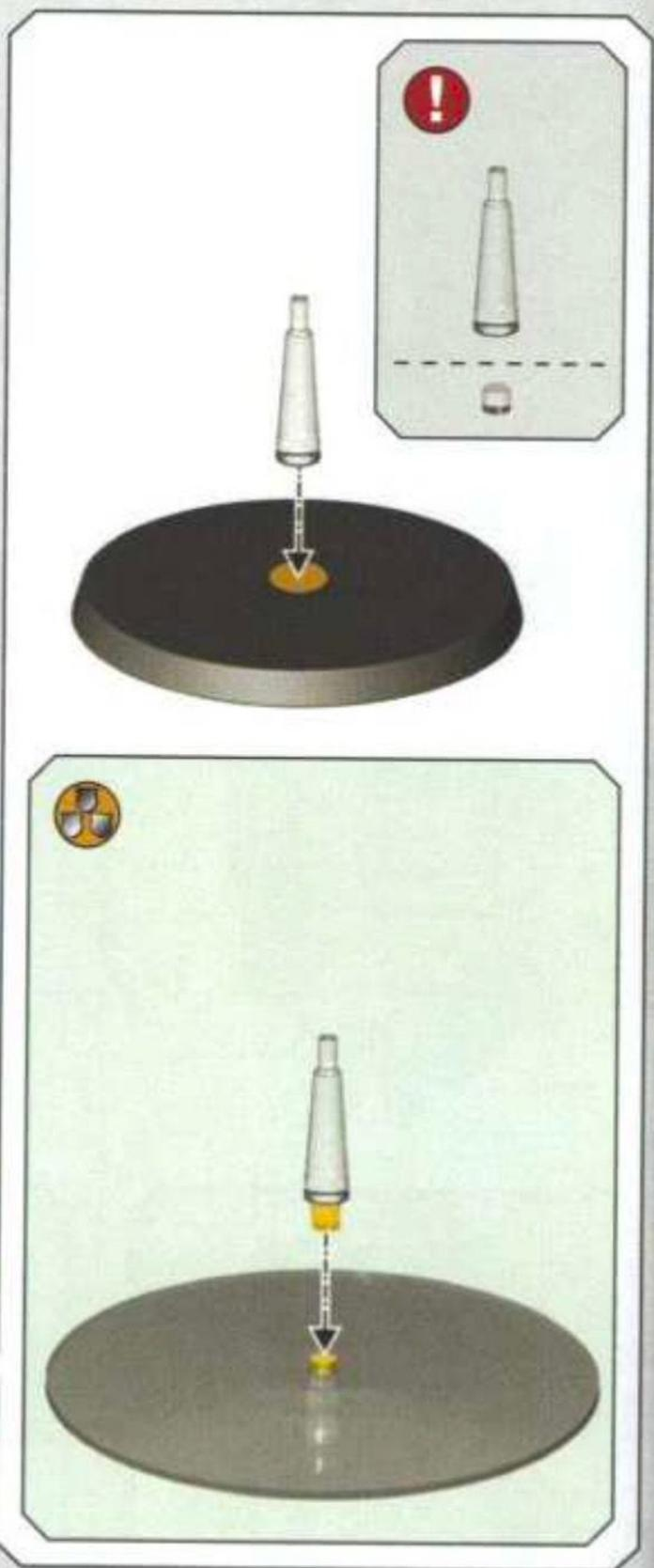



**CITADEL**  
PAINT SYSTEM



**BASE** BALTHASAR GOLD

**SHADE** REIKLAND FLESHSHADE

**LAYER** GEHENNA'S GOLD

**LAYER** STORMHOST SILVER

**BASE** ABADDON BLACK

**LAYER** DARK REAPER

**LAYER** THUNDERHAWK BLUE

**LAYER** ULTHUAN GREY



# JUNITH ERUITA

NAME	M	WS	BS	S	T	W	A	Ld	Sv
Junith Eruita	10"	2+	2+	3	4	7	4	9	3+

Junith Eruita is a single model equipped with: 2 heavy flammers; the Mace of Castigation. You can only include one of this model in your army.

WEAPONS	RANGE	TYPE	S	AP	D	ABILITIES
Heavy flamer	8"	Heavy D6	5	-1	1	When resolving an attack made with this weapon, do not make a hit roll: it automatically scores a hit.
The Mace of Castigation	Melee	Melee	+2	-1	2	-

## ABILITIES

**Acts of Faith, Sacred Rites, Shield of Faith**

**Rosarius:** This model has a 4+ invulnerable save.

**Fiery Conviction:** Re-roll hit rolls of 1 and wound rolls of 1 for attacks made by models in friendly **ORDER OF OUR MARTYRED LADY** units whilst their unit is within 6" of this model.

**The Pulpit of Saint Holline's Basilica:** The invulnerable save friendly **ADEPTA SORORITAS INFANTRY** models receive from the Shield of Faith ability is improved by 1, to a maximum of 4+, whilst their unit is within 6" of this model.

**Explodes:** When this model is destroyed, roll one D6 before removing it from play. On a 6 it explodes, and each unit within 3" suffers 1 mortal wound.

## FACTION KEYWORDS

**IMPERIUM, ADEPTUS MINISTORUM, ADEPTA SORORITAS, ORDER OF OUR MARTYRED LADY**

## KEYWORDS

**CHARACTER, VEHICLE, FLY, CANONESS SUPERIOR, JUNITH ERUITA**



# JUNITH ERUITA

NOM	M	CG	GT	F	E	PV	A	Ed	Sv
Junith Eruita	10"	2+	2+	3	4	7	4	9	3+

Junith Eruita est une figurine individuelle équipée de : 2 lance-flammes lourds ; la Masse de Castigation. Vous ne pouvez inclure cette figurine à votre armée qu'en un seul exemplaire.

ARMES	PORTÉE	TYPE	F	PA	D	APTITUDES
Lance-flammes lourd	8"	Lourde D6	5	-1	1	Quand vous résolvez une attaque de cette arme, ne faites pas de jet de touche : elle touche automatiquement.
La Masse de Castigation	Mêlée	Mêlée	+2	-1	2	-

## APTITUDES

**Actes de Foi, Rites Sacrés, Bouclier de la Foi**

**Rosarius :** Cette figurine a une sauvegarde invulnérable de 4+.

**Conviction Brûlante :** Relance les jets de touche de 1 et les jets de blessure de 1 pour les attaques des figurines de l'**ORDRE DE NOTRE-DAME DES MARTYRS** amies tant que leur unité est à 6" ou moins de cette figurine.

**Chaire de la Basilique Sainte Holine :** La sauvegarde invulnérable conférée par l'aptitude Bouclier de la Foi aux figurines d'**INFANTERIE** de l'**ADEPTA SORORITAS** amies est améliorée de 1, jusqu'à un maximum de 4+, tant que leur unité est à 6" ou moins de cette figurine.

**Explosion :** Quand cette figurine est détruite, jetez un D6 avant de la retirer du jeu. Sur 6 elle explose, et chaque unité à 3" ou moins subit 1 blessure mortelle.

## MOTS-CLÉS DE FACTION

**IMPERIUM, ADEPTUS MINISTORUM, ADEPTA SORORITAS, ORDRE DE NOTRE-DAME DES MARTYRS**

## MOTS-CLÉS

**PERSONNAGE, VÉHICULE, VOL, CANONESS SUPERIOR, JUNITH ERUITA**