



Free Downloads of Build Instructions,  
Assembly Booklets & How To Guides

**BuildInstructions.com**

# WARHAMMER

## THE HORUS HERESY

### LEGION SKY-HUNTER SQUADRON

**!** **READ THIS FIRST:** Before assembling your model kit, please read through the instructions in this booklet carefully. A pair of plastic cutters is required to remove the plastic components in this kit from their frame. We advise using a mouldline scraping tool to clean up the parts. To assemble your model, you will need plastic glue. Games Workshop sells Citadel Fine Detail Cutters, Citadel Mouldline Removers and Citadel Plastic Glue, but does not recommend these products for use by children under the age of 16 without adult supervision.

**À LIRE EN PREMIER :** Avant de vous lancer dans l'assemblage de ce kit, veuillez lire attentivement les instructions de ce livret. Une pince coupante est requise pour détacher chaque élément de sa grappe. Nous vous recommandons l'utilisation d'un grattoir pour ébarber les éléments. Pour l'assemblage, vous aurez également besoin de colle plastique. Games Workshop commercialise les Pinces de Précision Citadel, l'Ébarboir Citadel et la Colle Plastique Citadel, mais n'en recommande pas l'utilisation pour des enfants de moins de 16 ans sans la supervision d'un adulte.

**LEER ANTES DE MONTAR:** Antes de montar el contenido de este kit, lee estas instrucciones cuidadosamente. Te harán falta unas tenazas para plástico a fin de separar las piezas de la matriz. También aconsejamos una herramienta para rebabas a fin de limpiar cada pieza. Para montar la miniatura necesitarás pegamento para plástico. Games Workshop vende Tenazas Citadel, Herramientas para rebabas Citadel y Pegamento para plástico Citadel, pero no recomienda estos productos a menores de 16 años sin la supervisión de un adulto.

**LIES DIES ZUERST:** Bitte lies diese Anleitung sorgfältig, bevor du mit dem Zusammenbau deines Modells beginnst. Du benötigst einena Kunststoffseitenschneider, um die Kunststoffbauteile aus dem Gussrahmen herauszutrennen, und Kunststoffkleber, um die Miniatur zusammenzubauen. Außerdem empfehlen wir, die Bauteile vorher mit einem Gussgratentferner zu säubern. Games Workshop bietet Präzisions-Kunststoffseitenschneider von Citadel sowie Citadel-Kunststoffkleber an, empfiehlt aber, dass Kinder unter 16 Jahren diese nur unter Aufsicht eines Erwachsenen benutzen.

**LEGGI PRIMA QUESTO:** prima di assemblare il tuo modello, leggi le istruzioni di questo libretto con attenzione. Sono necessarie un paio di tronchesine per plastica per staccare i componenti dai loro sprue. Consigliamo di usare un attrezzo apposito per pulire i componenti. Per assemblare il modello avrai bisogno di colla per plastica. Games Workshop vende Tronchesine di precisione Citadel, Attrezzo per ripulire Citadel e Colla per plastica Citadel, ma non consiglia questi prodotti ad un pubblico minore di 16 anni senza la supervisione di un adulto.

**优先阅读：** 组装模型前，请先仔细阅读本手册中的说明。需要用模型剪钳将塑料部件从板件上剪下。我们推荐使用合模线清理工具来清理零件。用塑料粘胶来组装模型。Games Workshop 销售 Citadel 精密剪钳、Citadel 合模线刮刀和 Citadel 塑料粘胶，但不建议未满 16 岁的儿童在没有成人的监护下使用此类产品。

最初にお読みください：ミニチュアを組み立てる前に、この冊子の説明をよくお読みください。本セット内フレームからプラスチックパーツを切り取るためにプラスチック用ニッパーが必要となります。その後パーツを滑らかにするため、モールドラインを削るためのツールの使用を推奨します。モデルの組み立てには、プラスチック接着剤が必要となります。ゲームズワークショップでは「シタデルフラインディテールニッパー」「シタデルモールドラインリムーバー」「シタデルプラスチック接着剤」を販売していますが、これらは保護者の監督なしでの16歳以下のお子様の使用を推奨しません。



**16+**

**Citadel Plastic Glue**  
Colle plastique liquide Citadel  
Pegamento para plástico fluido  
Citadel-Kunststoffkleber  
Colla per plastica fluida Citadel  
Citadel 塑料灌嘴粘胶  
シタデルプラスチック接着剤流し込みタイプ



**Citadel Fine Detail Cutters**  
Pinces de précision Citadel  
Tenazas Citadel  
Citadel-Seitenschneider  
Tronchesine di precisione Citadel  
Citadel 精密剪钳  
シタデルフラインディテールニッパー



**Citadel Mouldline Remover**  
Ébarboir Citadel  
Herramienta para rebabas Citadel  
Gussgratentferner  
Attrezzo per ripulire Citadel  
Citadel 合模线刮刀  
シタデルモールドラインリムーバー

**EXPLANATION OF SYMBOLS - EXPLICATION DES SYMBOLES -  
EXPLICACIÓN DE SIMBOLOS - ERLÄUTERUNG DER SYMBOLE -  
LEGENDA DEI SIMBOLI - 符号説明・記号の説明**

<p><b>x3</b> Repeat process Répéter l'étape Repetir pasos Vorgang wiederholen Ripeti il processo 重复步骤 プロセスを繰り返す</p>	<p> Choice of parts Choix d'éléments Modelos de componentes Auswahl an Teilen Scelta di componenti 零件选择 パーツ選択</p>
<p> Rotate part Faire pivoter Girar la pieza Teil drehen Ruota il componente 旋轉部件 向きを変更</p>	<p> Variant assembly Variante d'assemblage Variante de montage Bauvariante Assemblaggio alternativo 多种组装方案 組み立てのバリエーション</p>
<p> Stage complete Étape terminée Paso completado Schritt abgeschlossen Fase completa 部件组装完成 完了</p>	<p> Dry fit stage before gluing Tester avant de coller Comprobar el encaje antes de pegar Positionierung erst ohne Klebstoff ausprobieren Prüfung ohne Klebstoff vor dem Kleben 使用胶水粘接前进行假组 接着前に組み合わせる</p>

# LEGION SKY-HUNTER SQUADRON

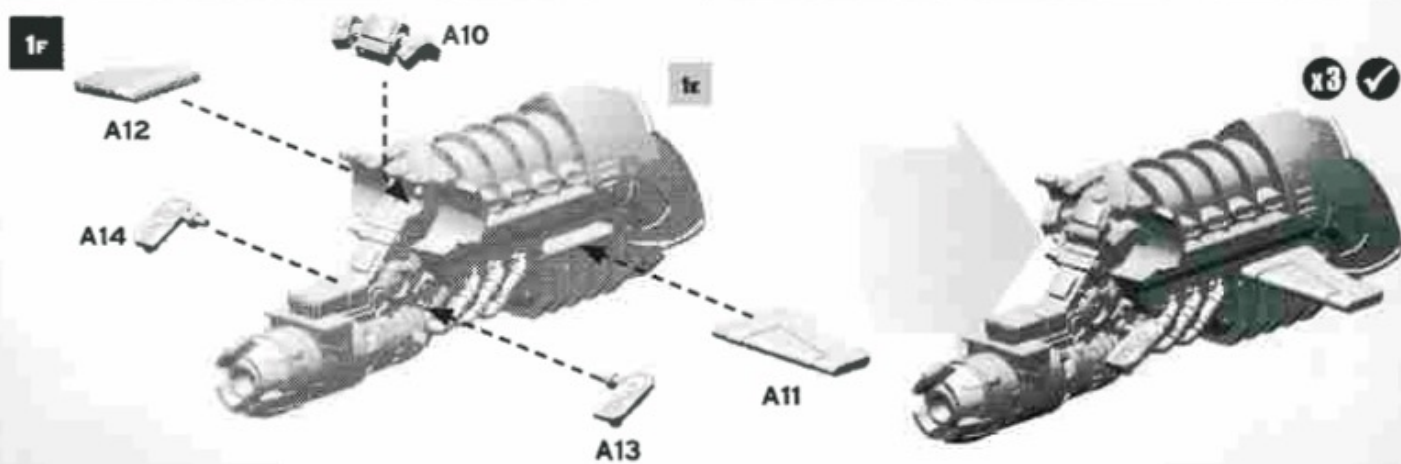
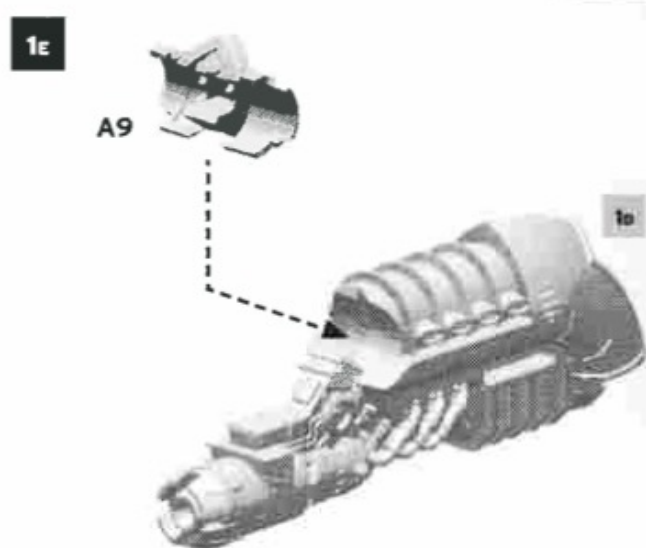
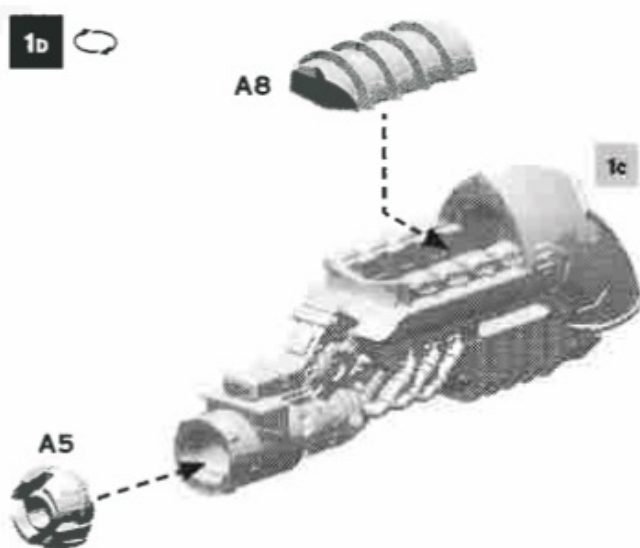
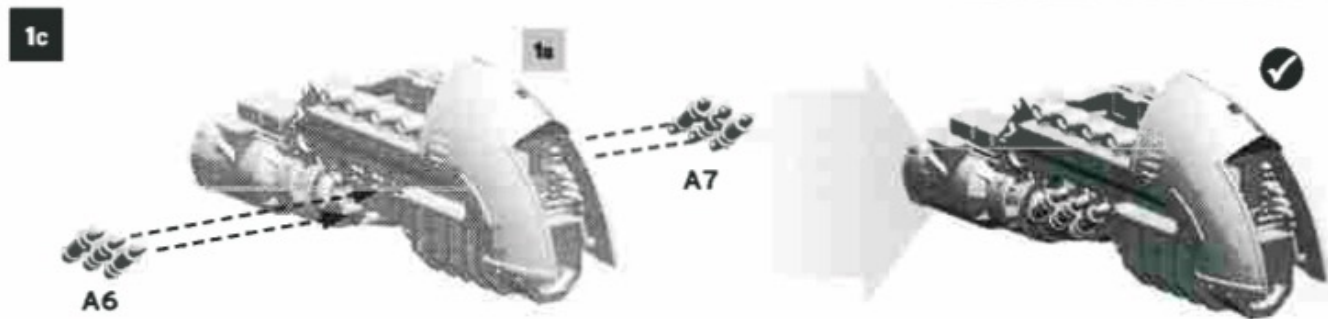
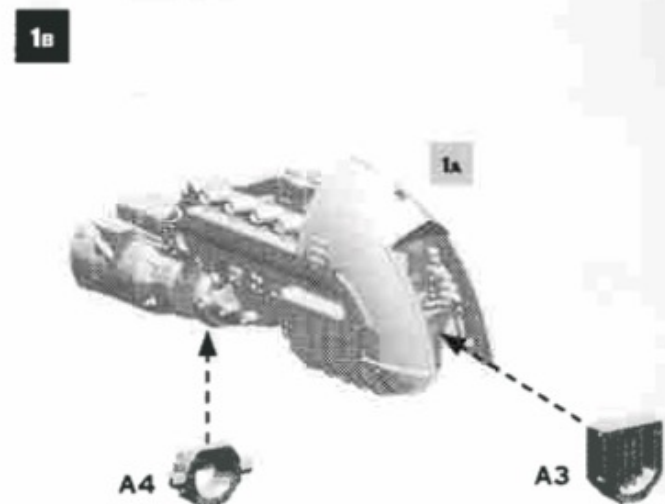
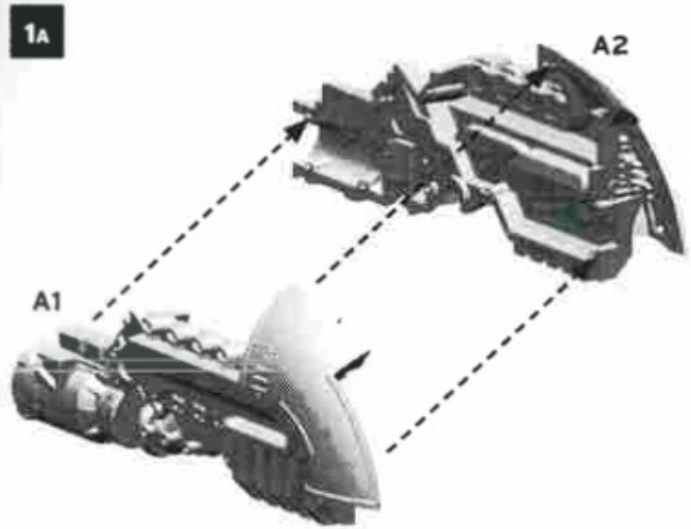



**WEAPONS**



Heavy Bolter



Multi-melta

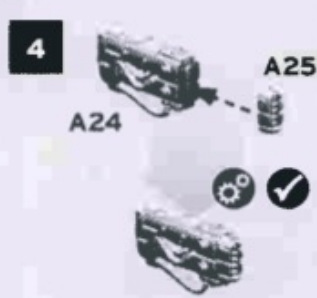

Volkite Culverin



Plasma Cannon

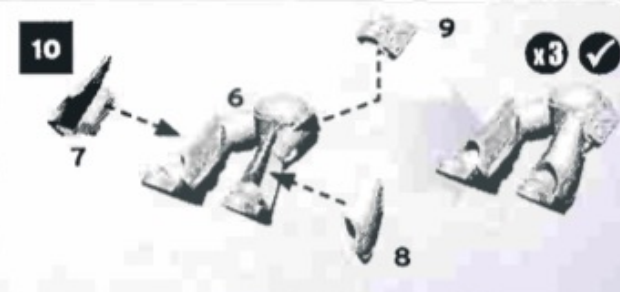
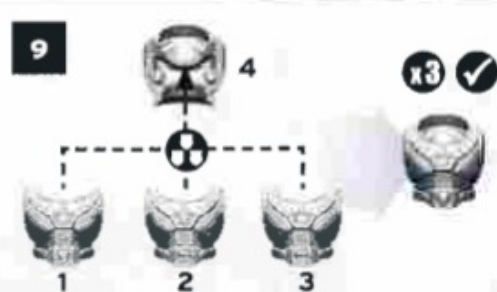
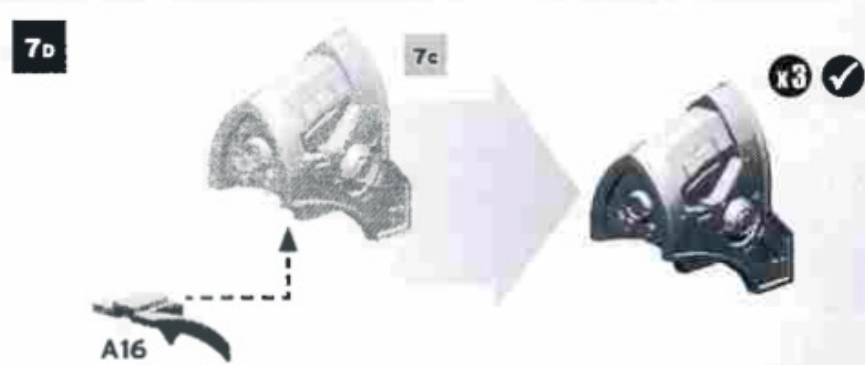
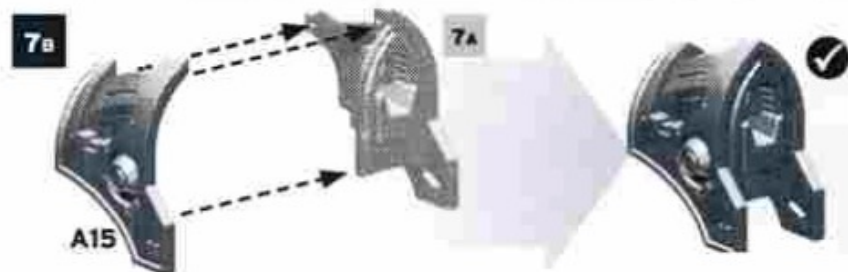
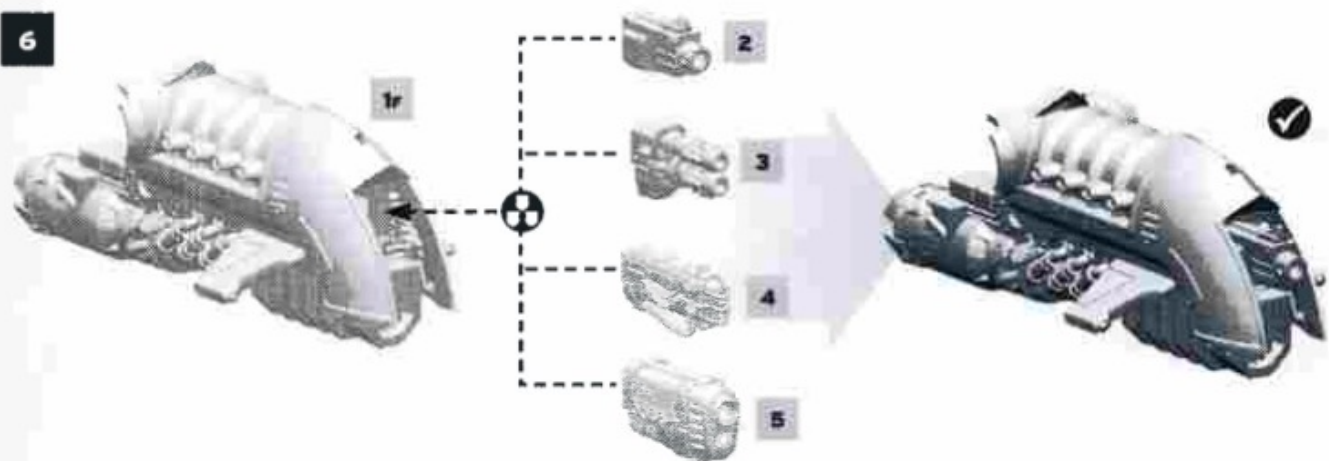

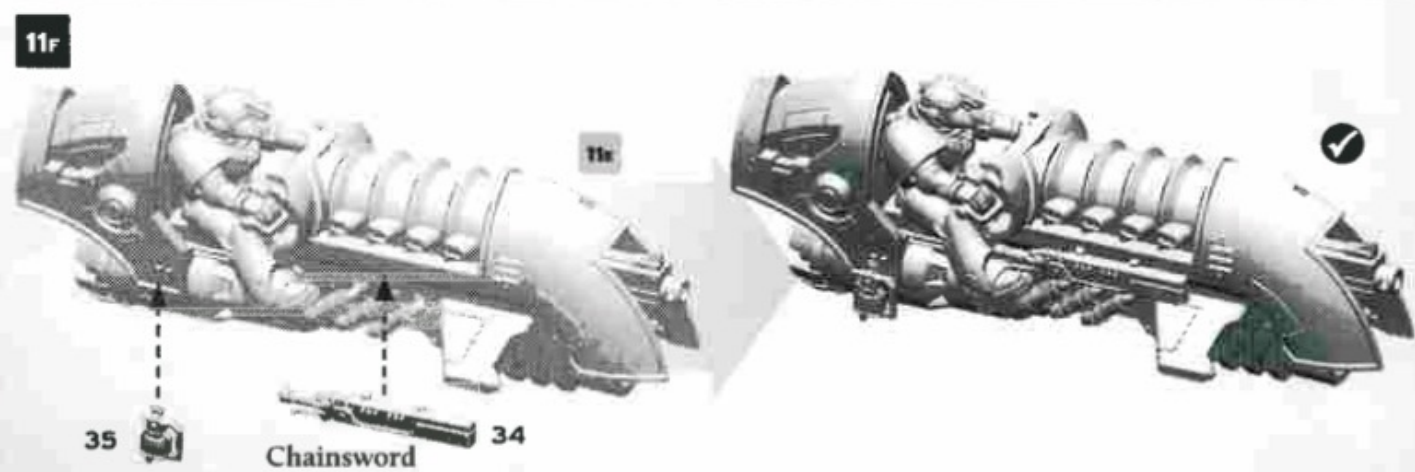
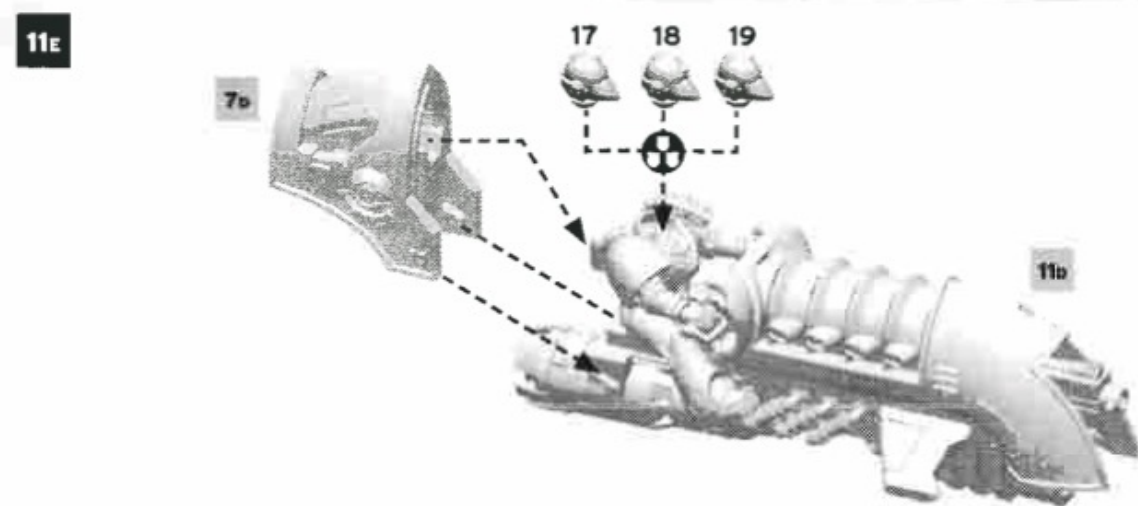
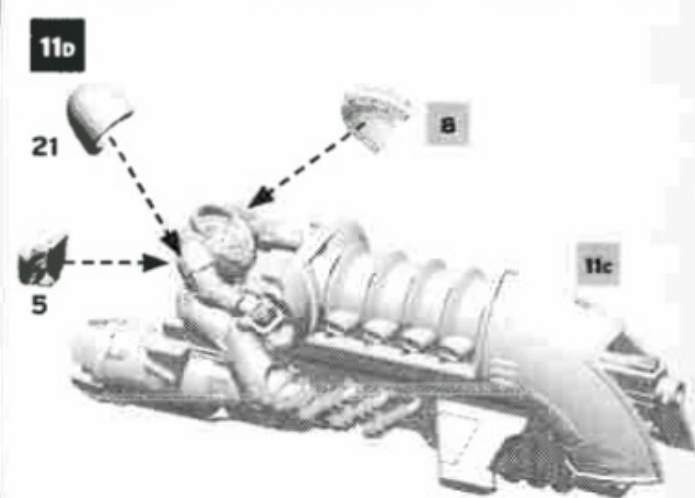
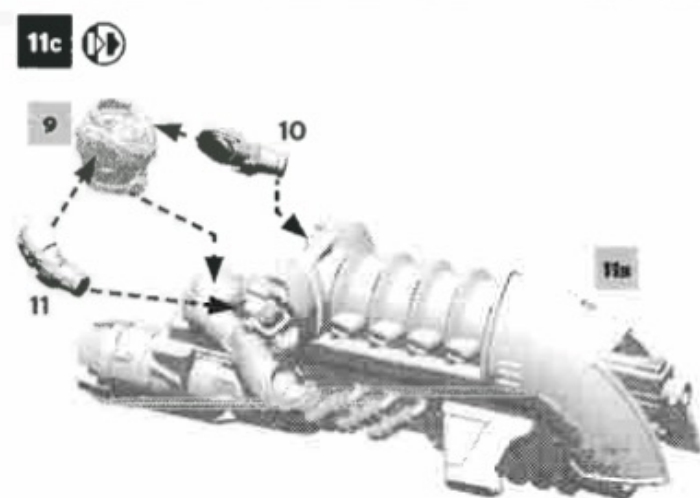
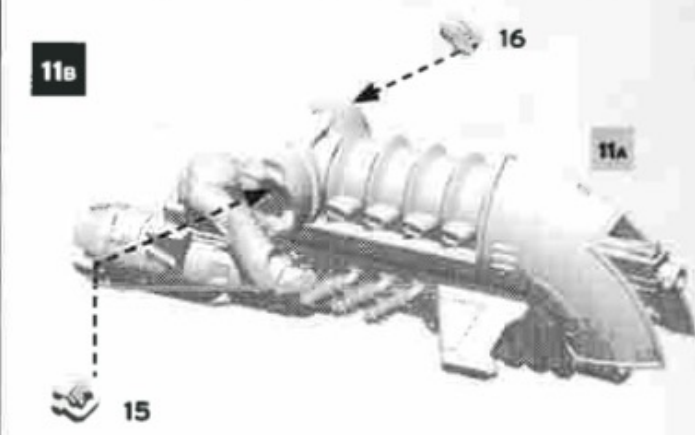
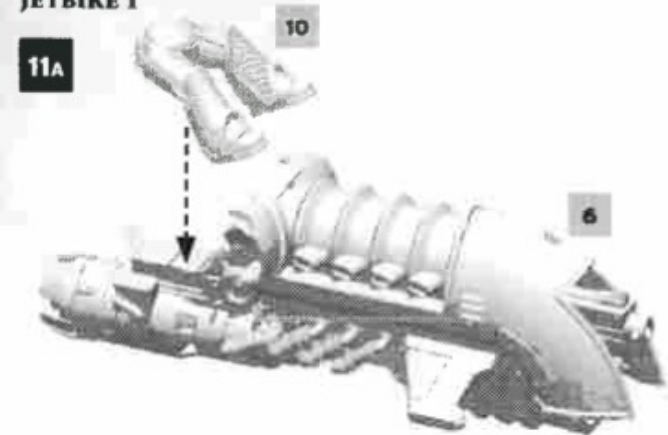
**JETBIKE I**

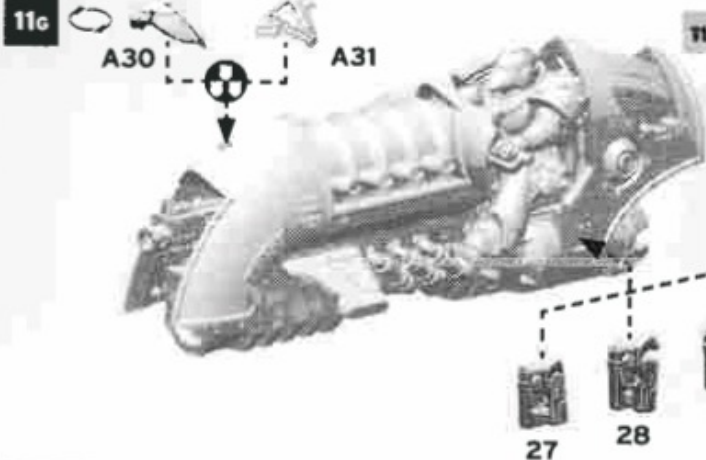

**11r**



**JETBIKE 2**

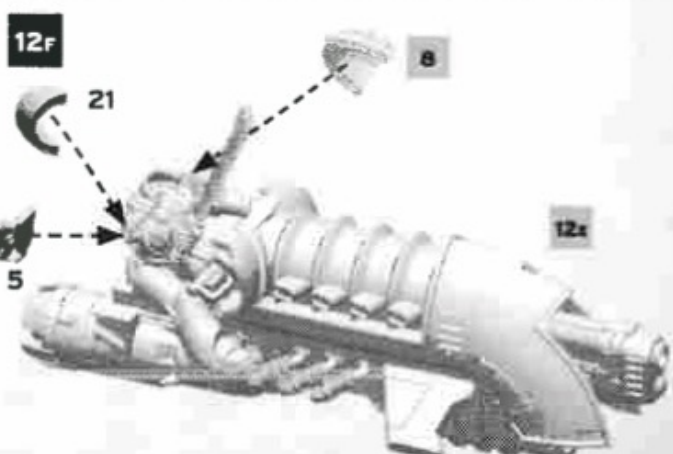
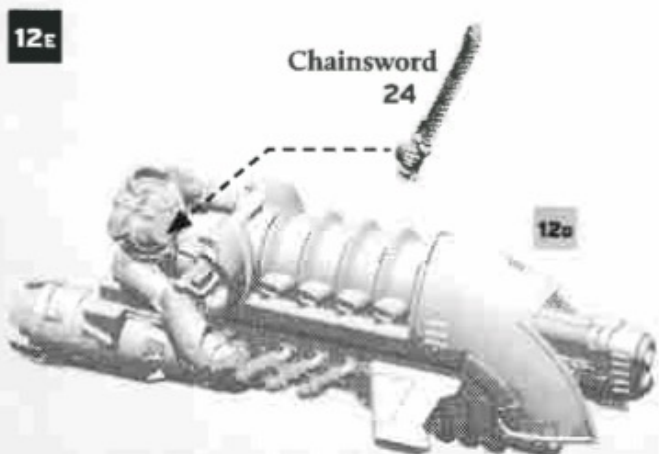
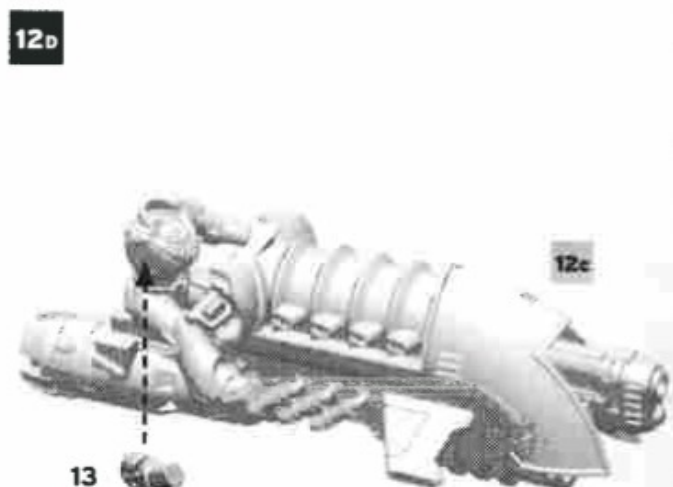
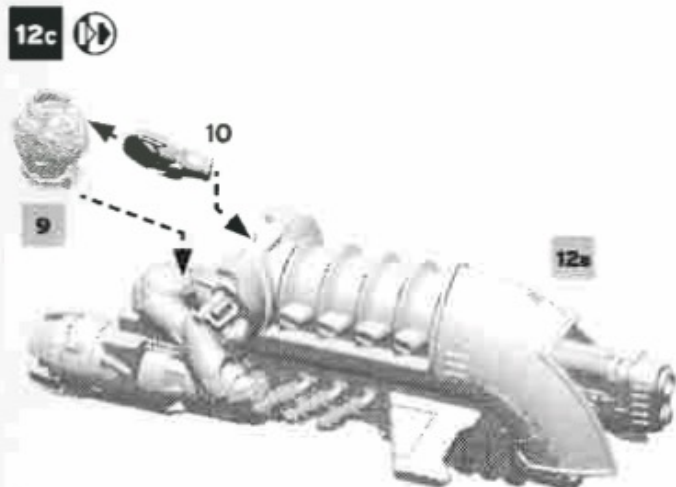
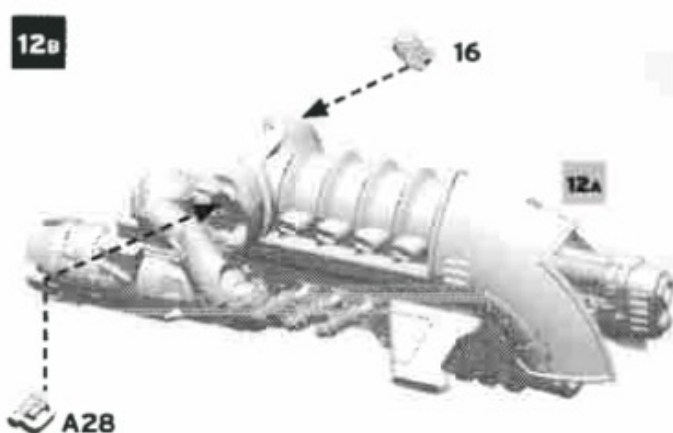
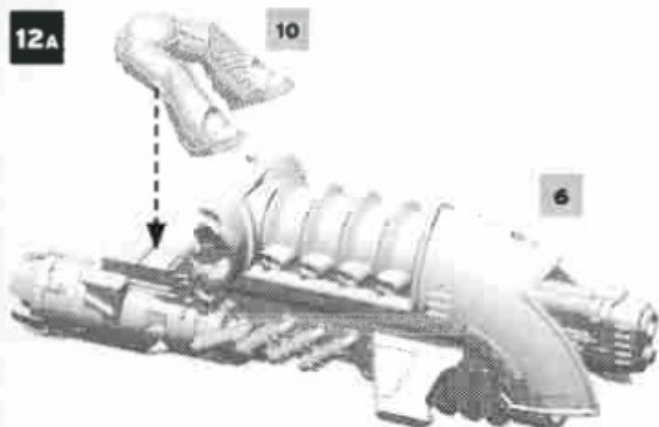



12g

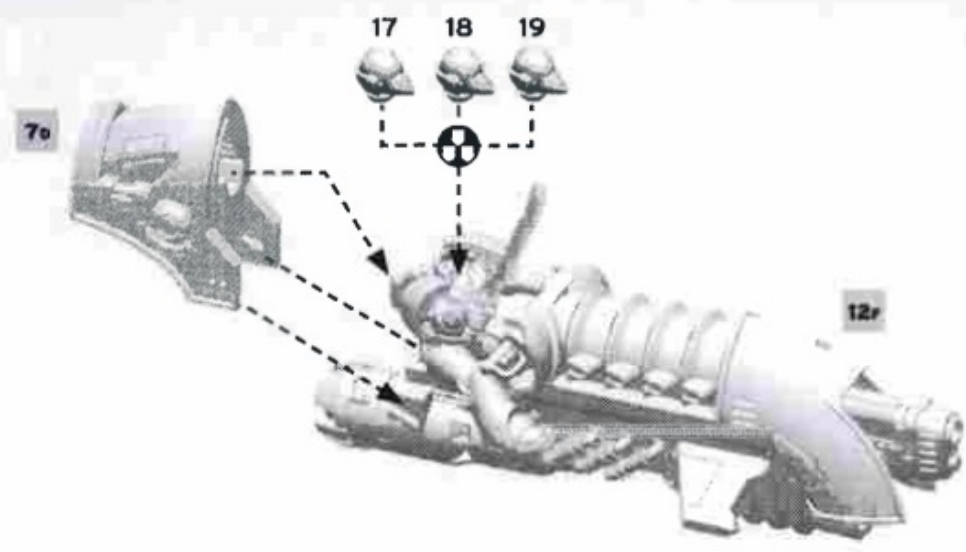

12h

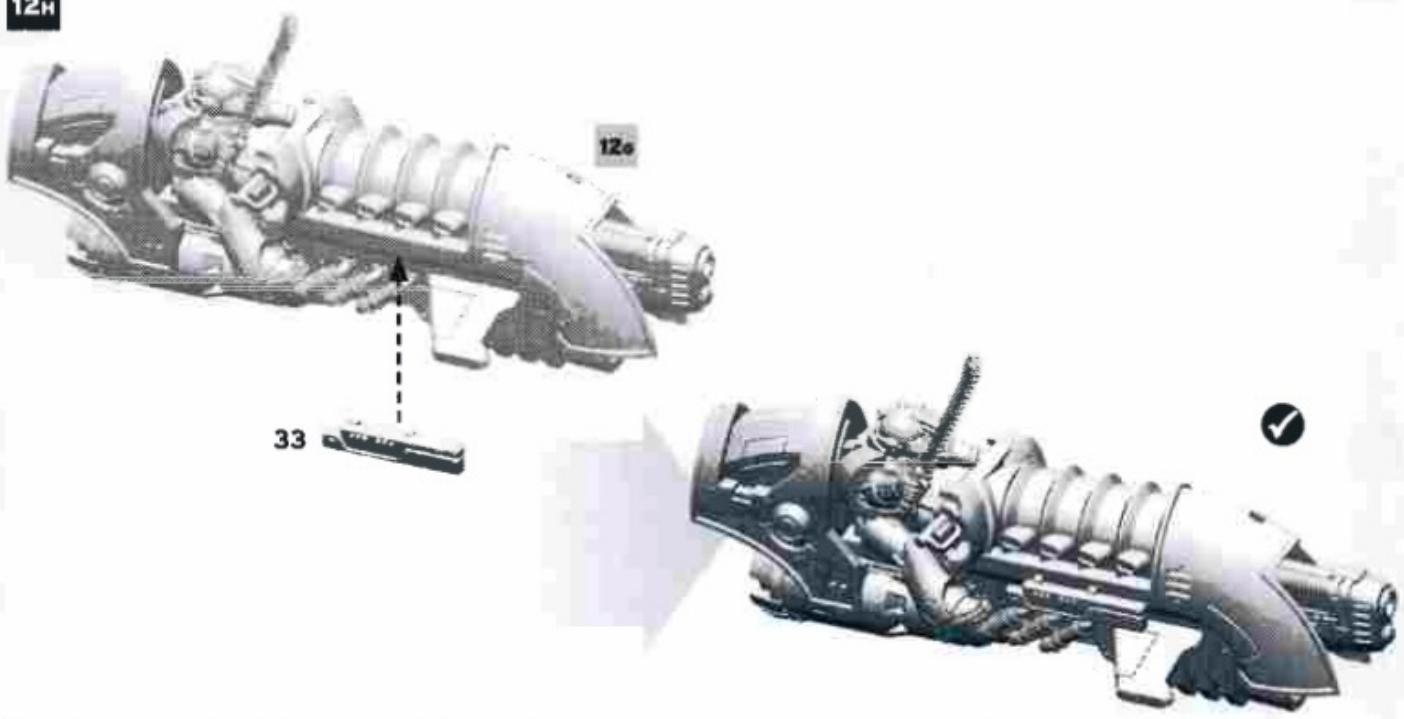

12i

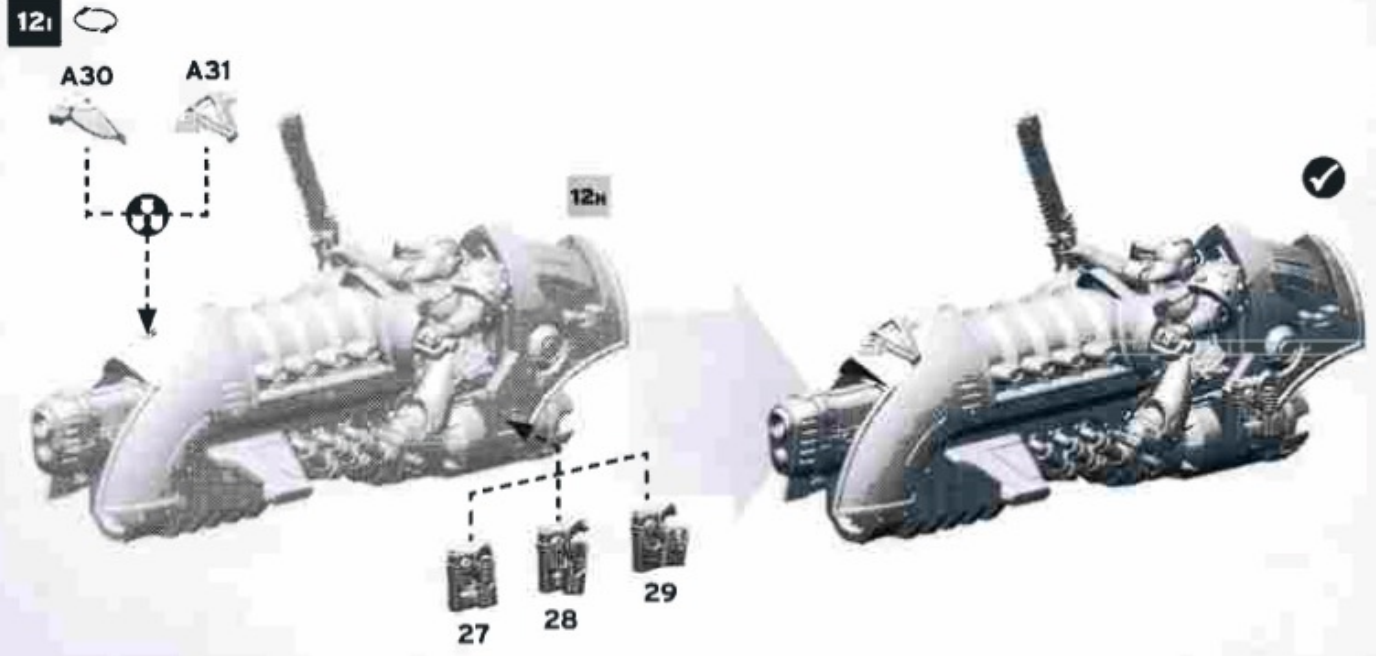

13A

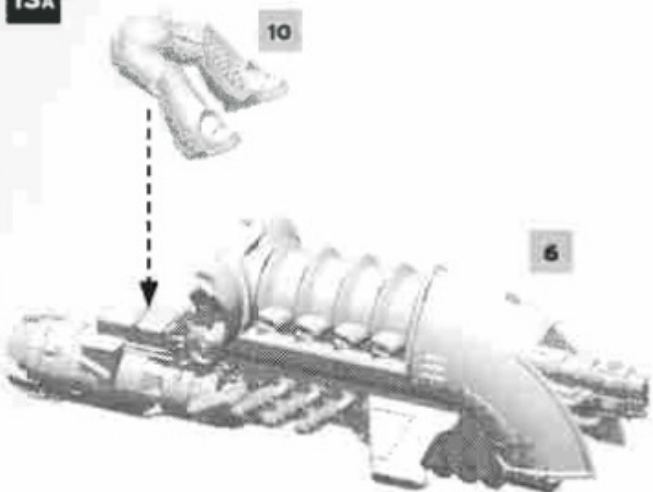

13B

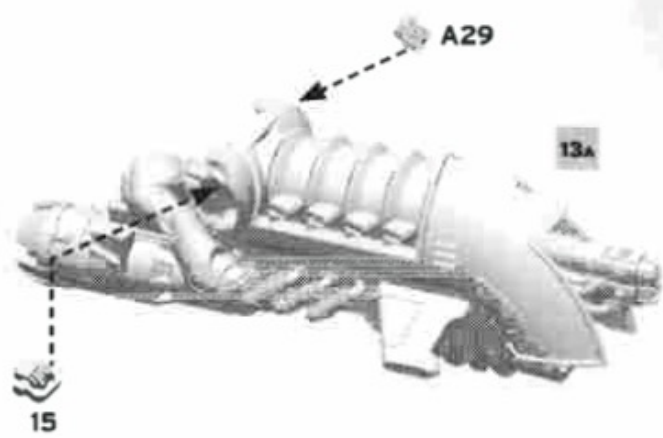

13c

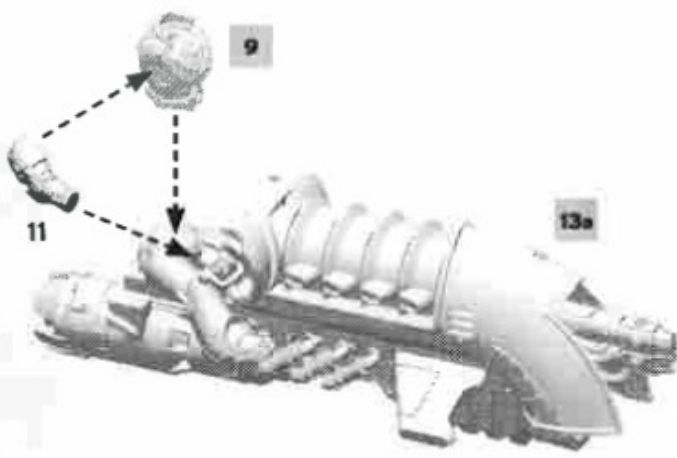

13d

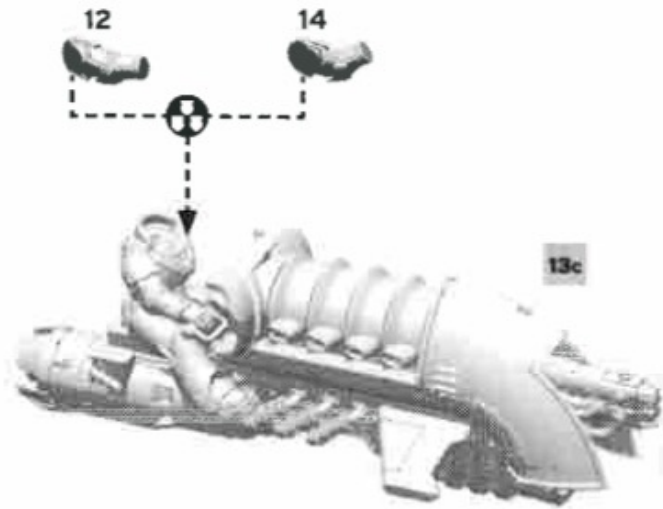

13E

Volkite Serpenta 31  
Hand Flamer 25

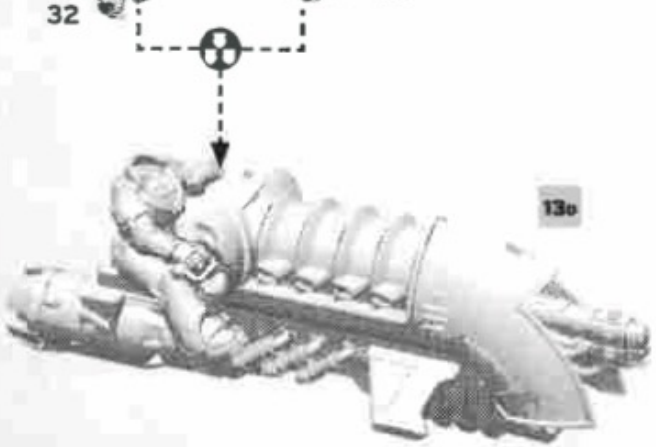

13F

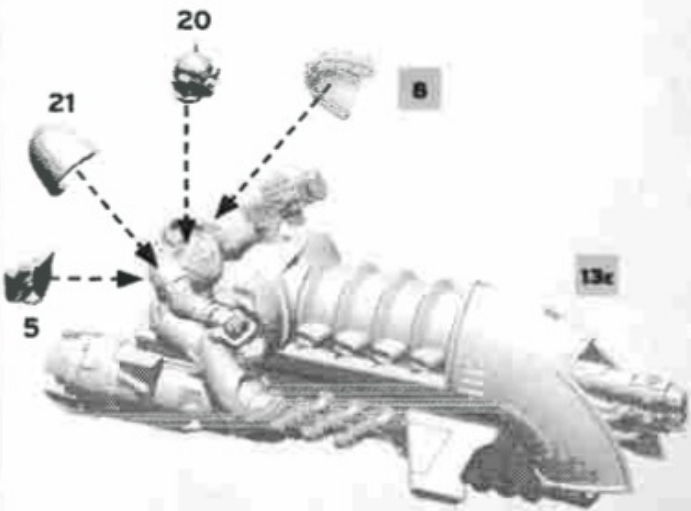

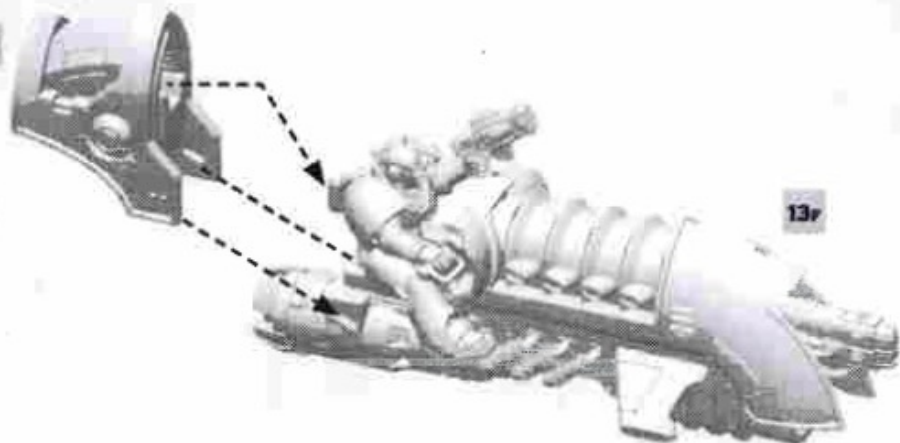
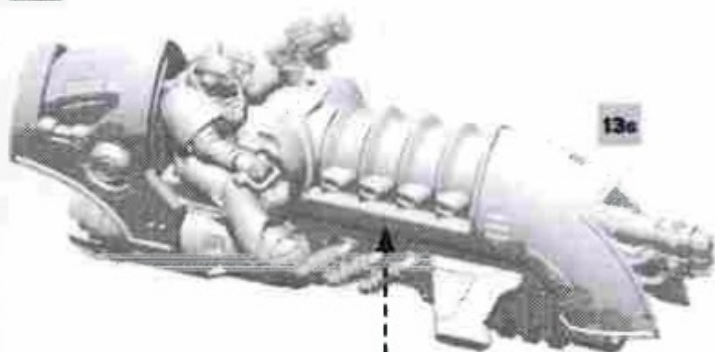

**13e****7e****13r****13H****13e****34****Chainsword****13i****A30****A31****13H****26****30**