



Free Downloads of Build Instructions,
Assembly Booklets & How To Guides

BuildInstructions.com

Forge World®

DEIMOS PATTERN DAMOCLES COMMAND RHINO

RESIN COMPONENTS

1. Ram
2. Upper Hatch x2
3. Right Cupola
4. Left Cupola
5. Front Plate
6. Exhaust x4
7. Right Side
8. Bolter x2
9. Left Side
10. Left Door x2
11. Right Door x2
12. Comms Dish Mount
13. Comms Pack
14. Comms Dish Antennae
15. Multi-spectral Auspex
16. Comms Dish
17. Upper Hull Plate

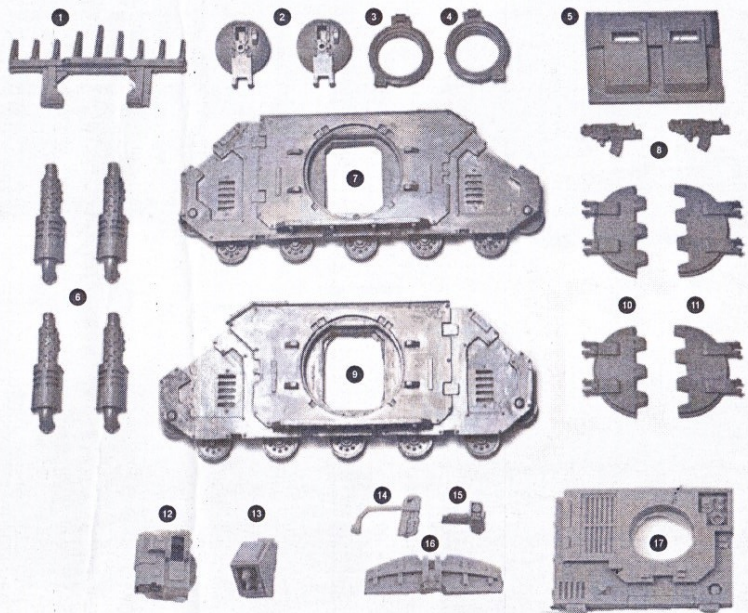

Many of the resin parts in this kit directly replace the equivalent plastic part.

This kit contains all the pieces required to construct a Deimos Pattern Damocles Command Rhino. To glue the resin pieces together, use Citadel Super Glue.

NOTE: We have cast this kit using the most advanced techniques and the best quality resin, but due to the nature of the casting process your model may contain very slight air bubbles. These can easily be filled with model filler or super glue. Any slight warpage of thin parts can be corrected by immersing the part in hot tap water for about one minute then carefully bending it back into shape.

THIS IS NOT A TOY

Not suitable for children under 15 years of age.

WARNING: Resin dust can be harmful if inhaled. Always wear a dust mask or respirator when sanding or sawing resin parts.

Forge World®

DEIMOS PATTERN DAMOCLES COMMAND RHINO - ASSEMBLY GUIDE

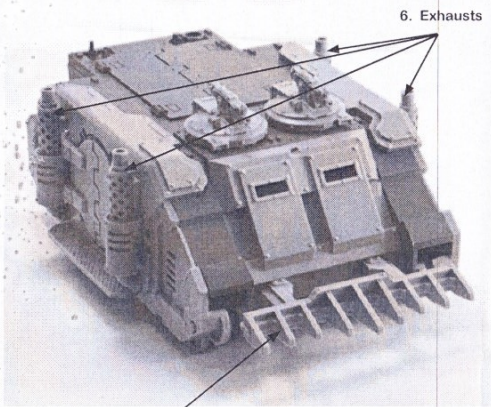

Assembling the Command and Communications Array
Take care when assembling the Command and Communications Array if you require it to rotate and elevate. If you want it to rotate, do not glue the Comms Dish Mount to the Upper Hull Plate.

To allow the Array to elevate, the shaft of the Multi-spectral Auspex threads through the Comms Dish Mount and the Comms Dish Antennae. Make sure no glue contacts the Comms Dish Antennae and it should freely move up and down.

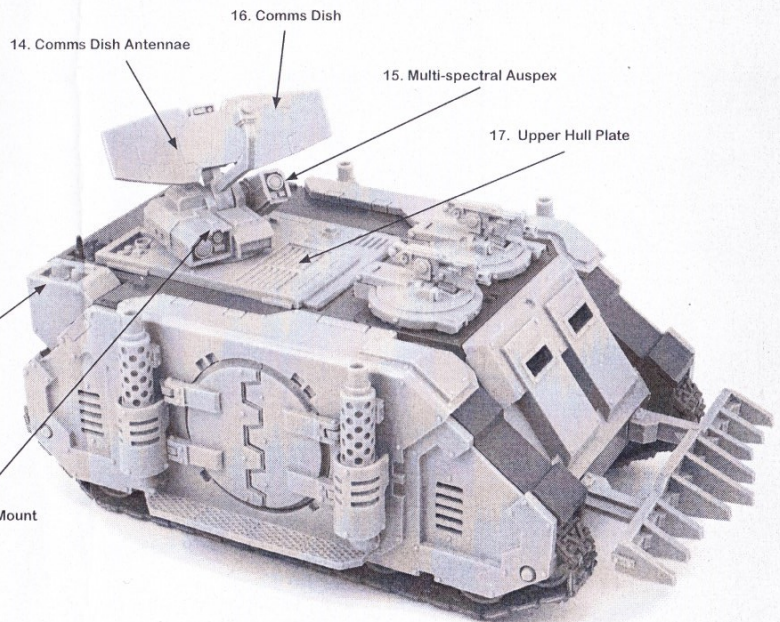

TRACK ASSEMBLY

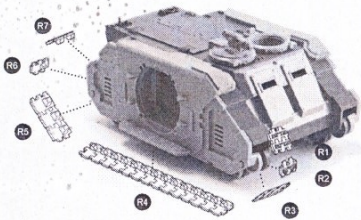

Repeat for the Left hand track assembly using parts L1 to L7

Forge World®

DEIMOS PATTERN DAMOCLES COMMAND RHINO - ASSEMBLY GUIDE

Certain resin parts included in this kit directly replace the equivalent plastic components of the plastic Rhino kit. For the Command and Communications Array of the Damocles Command Rhino, you do not need to use the Upper Hatches from the Deimos Rhino kit as these will be replaced by the Upper Hull Plate.

Do not add the Upper Hatches.

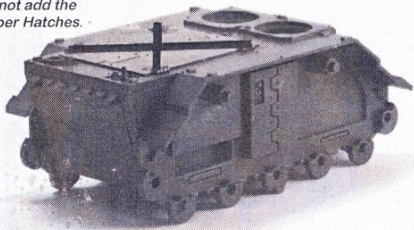

Assemble the plastic Rhino up to this stage.

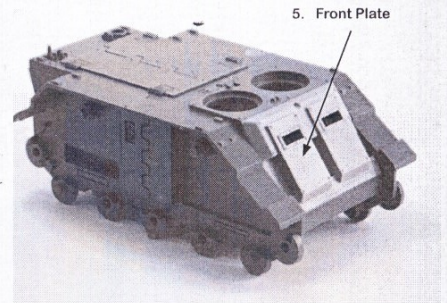
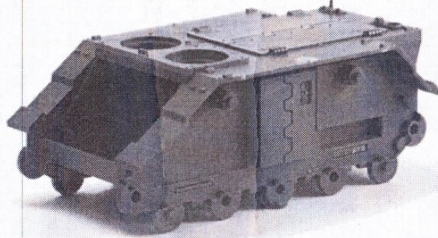

5. Front Plate

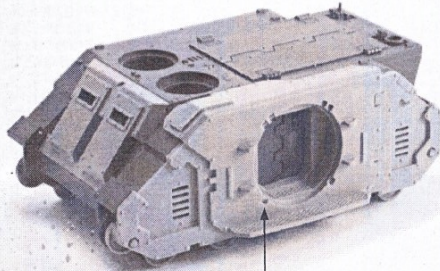

9. Left Side

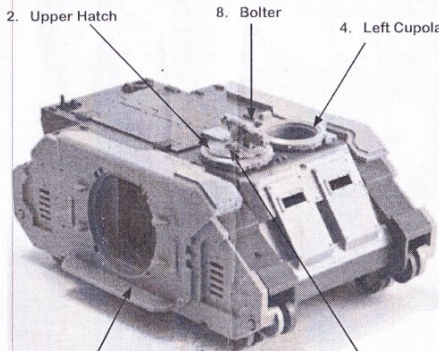

2. Upper Hatch

8. Bolter

4. Left Cupola

7. Right Side

3. Right Cupola

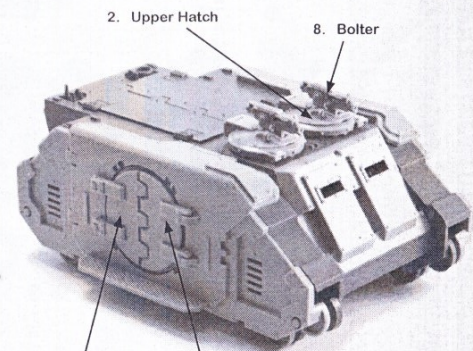

2. Upper Hatch

8. Bolter

10. Left Door

11. Right Door