



Free Downloads of Build Instructions,  
Assembly Booklets & How To Guides

**BuildInstructions.com**

# WARCRY

## SUNDERED FATE

DESTIN BRISÉ • DESTINO QUEBRADO • KAMPF UM DIE SCHUPPEN • FATO SPEZZATO  
РАЗБИТАЯ СУДЬБА • サンダード・フェイト • 破砕命運

READ THIS FIRST • À LIRE EN PRIORITÉ • BITTE BEACHTE • LEE ESTO PRIMERO • LEGGI PRIMA QUESTO  
В ПЕРВУЮ ОЧЕРЕДЬ ПРОЧИТАЙТЕ ЭТО • 最初にお読みください。 • 请优先阅读

**ENG** BEFORE ASSEMBLING YOUR MINIATURES, PLEASE READ THROUGH THE INSTRUCTIONS IN THIS BOOKLET CAREFULLY. A pair of plastic cutters is required to remove the plastic components in this kit from their frame. We advise using a mouldline scraping tool to clean up the parts. To assemble your model you will need plastic glue. Games Workshop sells Citadel Fine Detail Cutters, Citadel Mouldline Remover and Citadel Plastic Glue, but does not recommend these products for use by children under the age of 16 without adult supervision.

**FRE** AVANT D'ASSEMBLER VOS FIGURINES, VEUILLEZ LIRE ATTENTIVEMENT LES INSTRUCTIONS DE CE LIVRET. Une pince coupante est requise pour détacher chaque élément de sa grappe. Nous vous recommandons l'utilisation d'un grattoir pour ébarber les éléments. Pour l'assemblage, vous aurez également besoin de colle plastique. Games Workshop commercialise les Pinces de Précision Citadel, l'Ebarboir Citadel et la Colle Plastique Citadel, mais n'en recommande pas l'utilisation pour des enfants de moins de 16 ans sans la supervision d'un adulte.

**SPA** POR FAVOR, LEE CUIDADOSAMENTE ESTE LIBRETO DE INSTRUCCIONES ANTES DE EMPEZAR A MONTAR LAS MINIATURAS. Te harán falta unas tenazas para plástico a fin de separar las piezas de la matriz. También aconsejamos una herramienta para rebabas a fin de limpiar cada pieza. Para montar la miniatura necesitarás pegamento para plástico. Games Workshop vende Tenazas Citadel, Herramientas para rebabas Citadel y Pegamento para plástico Citadel, pero no recomienda estos productos a menores de 16 años sin la supervisión de un adulto.

**GER** VOR DEM ZUSAMMENBAU DER MINIATUREN BITTE DIE ANWEISUNGEN IN DIESER ANLEITUNG AUFMERKSAM DURCHLESEN. Du benötigst einen Kunststoffseitenschneider, um die Kunststoffbauteile aus dem Gussrahmen herauszutrennen, und Kunststoffkleber, um die Miniatur zusammenzubauen. Außerdem empfehlen wir, die Bauteile vorher mit einem Gussgratentferner zu säubern. Games Workshop bietet Präzisions-Kunststoffseitenschneider von Citadel sowie Citadel-Kunststoffkleber an, empfiehlt aber, dass Kinder unter 16 Jahren diese nur unter Aufsicht eines Erwachsenen benutzen.

**ITA** PRIMA DI ASSEMBLARE LE TUE MINIATURE LEGGI ATTENTAMENTE TUTTE LE ISTRUZIONI DI QUESTO LIBRETTO. Sono necessarie un paio di tronchesine per plastica per staccare i componenti dai loro sprue. Consigliamo di usare un attrezzo apposto per pulire i componenti. Per assemblare il modello avrai bisogno di colla per plastica. Games Workshop vende Tronchesine di precisione Citadel, Attrezzo per ripulire Citadel e Colla per plastica Citadel, ma non consiglia questi prodotti ad un pubblico minore di 16 anni senza la supervisione di un adulto.

**RUS** КУСАЧКИ ДЛЯ ПЛАСТИКА НУЖНЫ ДЛЯ СНЯТИЯ ПЛАСТИКОВЫХ ЭЛЕМЕНТОВ НАБОРА С РАМОК. Для зачистки деталей рекомендуем использовать инструмент для удаления дефектов. Для сборки модели вам понадобятся клей для пластика. Компания Games Workshop предоставляет кусачки «Citadel Fine Detail Cutters», инструмент для удаления дефектов «Citadel Mouldline Remover» и клей для пластика «Citadel Plastic Glue», но не рекомендует эти изделия к использованию детьми младше 16 лет без надзора взрослых.

**日英** 本キット内のフレームからプラスチックパーツを切り離すためには、ニッパーが必要です。パーツのモールドを平らにするには、専用ツールの使用をお勧めいたします。本キットの組み立てには、プラ用接着剤が必要です。ゲームズワークショップはシタデル・ニッパー、プラ用接着剤、シタデル・モールドラインリムーバーを販売しておりますが、16歳以下の子供が大人の監督なしにこれらの道具を使用されることをお勧めしません。

**中文** 你需要一把模型剪将塑料部件从板件上剪下来。我们建议使用分模线刮刀来处理零件。组装时你还需要用到模型胶水。你可以从 Games Workshop 处购买到 Citadel Fine Detail Cutter 模型剪、Citadel Mouldline Remover 分模线刮刀和 Citadel Plastic Glue 模型胶。但 16 岁以下儿童不得在没有成年人监护的情况下使用这些产品。

EXPLANATION OF SYMBOLS • EXPLICATION DES SYMBOLES • EXPLICACIÓN DE SÍMBOLOS • ERLÄUTERUNG DER SYMBOLE  
LEGENDA DEI SIMBOLI • РАСШИФРОВКА СИМВОЛОВ • アイコン解説 • 符号说明

 • Special instruction - Take care  
• Instruction spéciale - Faites attention  
• Instrucciones especiales - Presta atención  
• Besondere Anweisung - bitte beachten  
• Istruzioni speciali: prestare attenzione  
• Особая инструкция - Будьте осторожны  
• 特記事項 - 要注意  
• 特别说明 - 小心

 • Variant assembly  
• Variante d'assemblage  
• Variante de montaje  
• Bauvariante  
• Assemblaggio alternativo  
• Варианты сборки  
• 組み立てバリエーション  
• 多种组装方式

 • Choice of parts  
• Choix d'éléments  
• Modelos de componentes  
• Auswahl an Teilen  
• Scelta di componenti  
• Выбор деталей  
• パーツの選択  
• 选择部件

 • Paint before assembly  
• Peindre avant assemblage  
• Pintar antes del montaje  
• Erst bemalen, dann zusammenbauen  
• Dipingi prima dell'assemblaggio  
• Покрасьте перед сборкой  
• 組み立て前にペイントすること  
• 组装前涂装

 • Do not glue the components  
• Ne pas coller les éléments  
• No pegar los componentes  
• Bitte die Teile nicht kleben  
• Non incollare i componenti  
• Не склеивайте детали  
• このパーツは接着不可  
• 请勿粘接



**!** USE CORRECT BASES • UTILISEZ LES SOCLEs APPROPRIÉS • USA LAS PEANAS CORRECTAS • BASEGRÖSSEN BEACHTEN  
 USA LE Basette CORRETTE • ИСПОЛЬЗУЙТЕ ПОДХОДЯЩИЕ ПОДСТАВКИ • 適切なベースサイズ • 使用正确的底座

- Your models are supplied with different-sized bases. Use the diagram on the right to help you to determine which is the correct base for the model you are building.
- Vos figurines sont fournies avec des socles de tailles variées. Utilisez le diagramme ci-contre pour vous aider à déterminer quel est le socle adapté à la figurine que vous assemblez.
- Tus miniaturas se suministran con peanas de diferentes tamaños. Usa el diagrama a la derecha para ayudarte a determinar cuál es la peana correcta para la miniatura que estás montando.
- Für jede Miniatur ist eine bestimmte Basegröße vorgesehen. Mit dem Diagramm rechts kannst du bestimmen, welches Base zu dem Modell gehört, das du gerade zusammenbaust.

- I tuoi modelli sono forniti con basette di dimensioni differenti. Usa l'immagine a destra per aiutarti a determinare qual è la basetta corretta per il modello che stai assemblando.
- Ваши модели поставляются с подставками разных размеров. Схема справа поможет вам выбрать подставку, подходящую для модели, которую вы собираете.
- ミニチュアにはそれぞれ異なる大きさのベースが付属している。右の図を参考に、組み立て中のミニチュアに対応した適切なベースを使用すること。
- 我们为模型提供了不同尺寸的底座。请使用右侧的图示协助您判断哪种尺寸的底座适合您正在组装的模型。

**1:1**

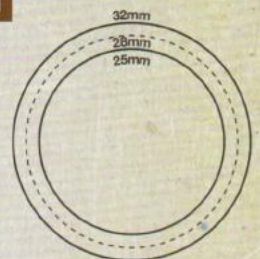

**!** BUILD VARIANTS • VARIANTES D'ASSEMBLAGE • VARIANTES DE MONTAJE • BAUVARIANTEN  
 VARIANTI D'ASSEMBLAGGIO • ВАРИАНТЫ СБОРКИ • バリエーション • 变体版

- Assemblies for build variants are colour coded.
- Les assemblages de variantes ont un code couleur.
- Las instrucciones para montajes alternativos se indican con un color diferente.
- Optionen für Bauvarianten sind farblich markiert.
- Le diverse varianti d'assemblaggio sono divise per colore.
- Различные варианты сборки выделены разными цветами.
- バリエーション違いの組み立ては色分けされている。
- 变体版拼装部件有颜色区分。



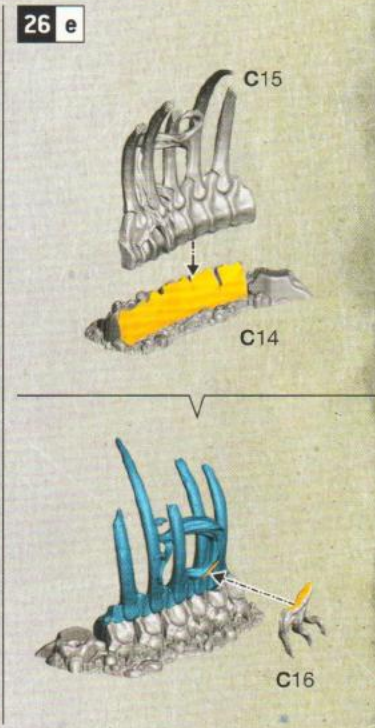
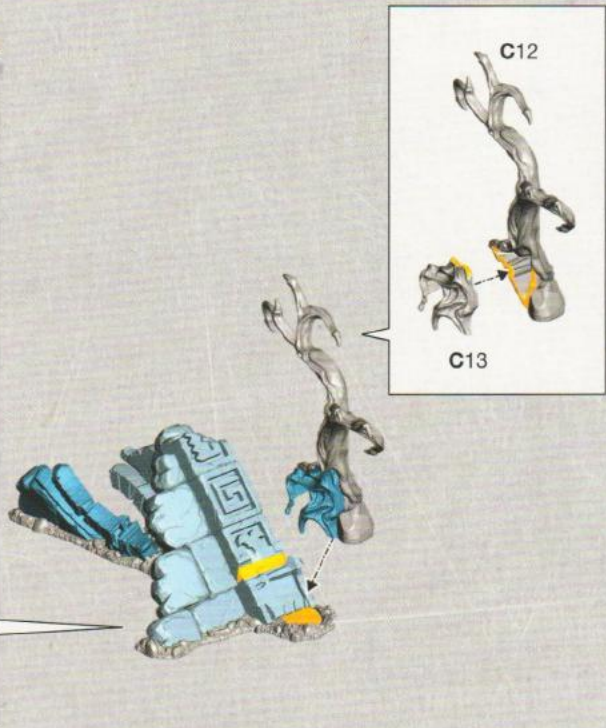
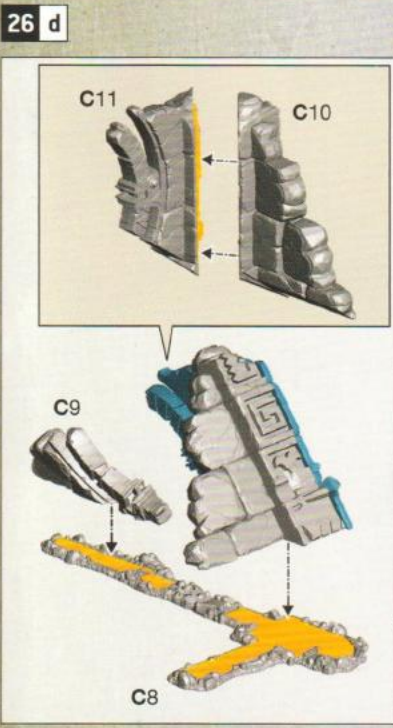
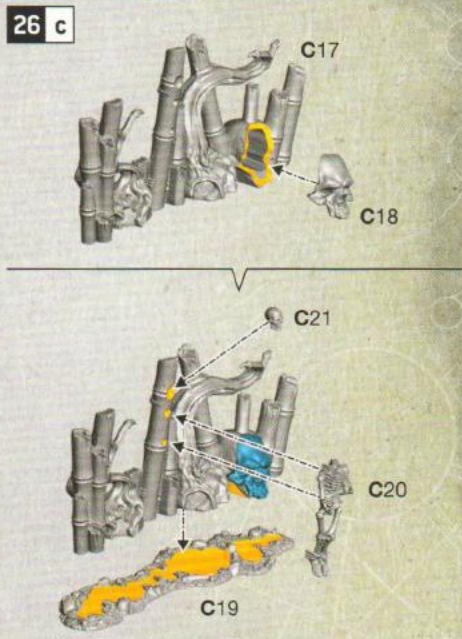
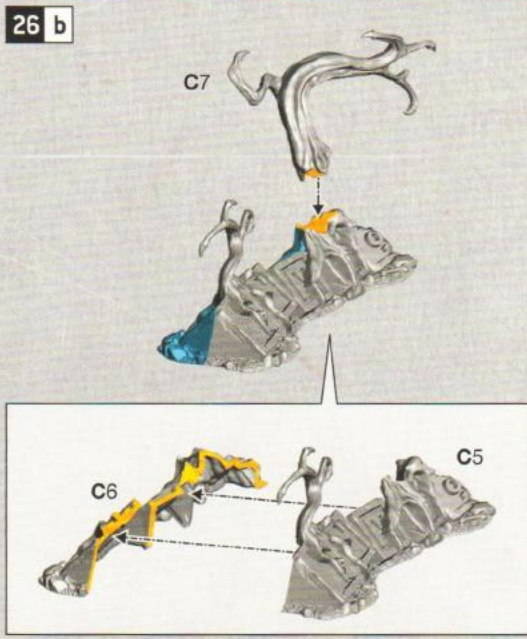
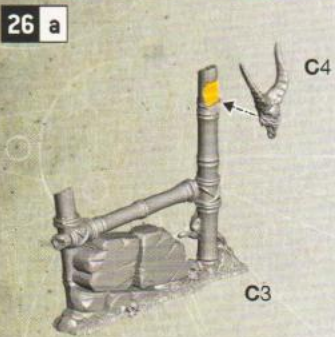

 **• Ribcages • Cages thoraciques • Costillares**  
**• Brustkorb • Casse toracique • Рёбра**  
**• あばらの籠 • 胸骨**

**• Rope bridges • Ponts de corde • Puentes de cuerdas • Hängebrücken • Ponti di funi**  
**• Висячие мосты • 繩橋 • 繩桥**



27 a

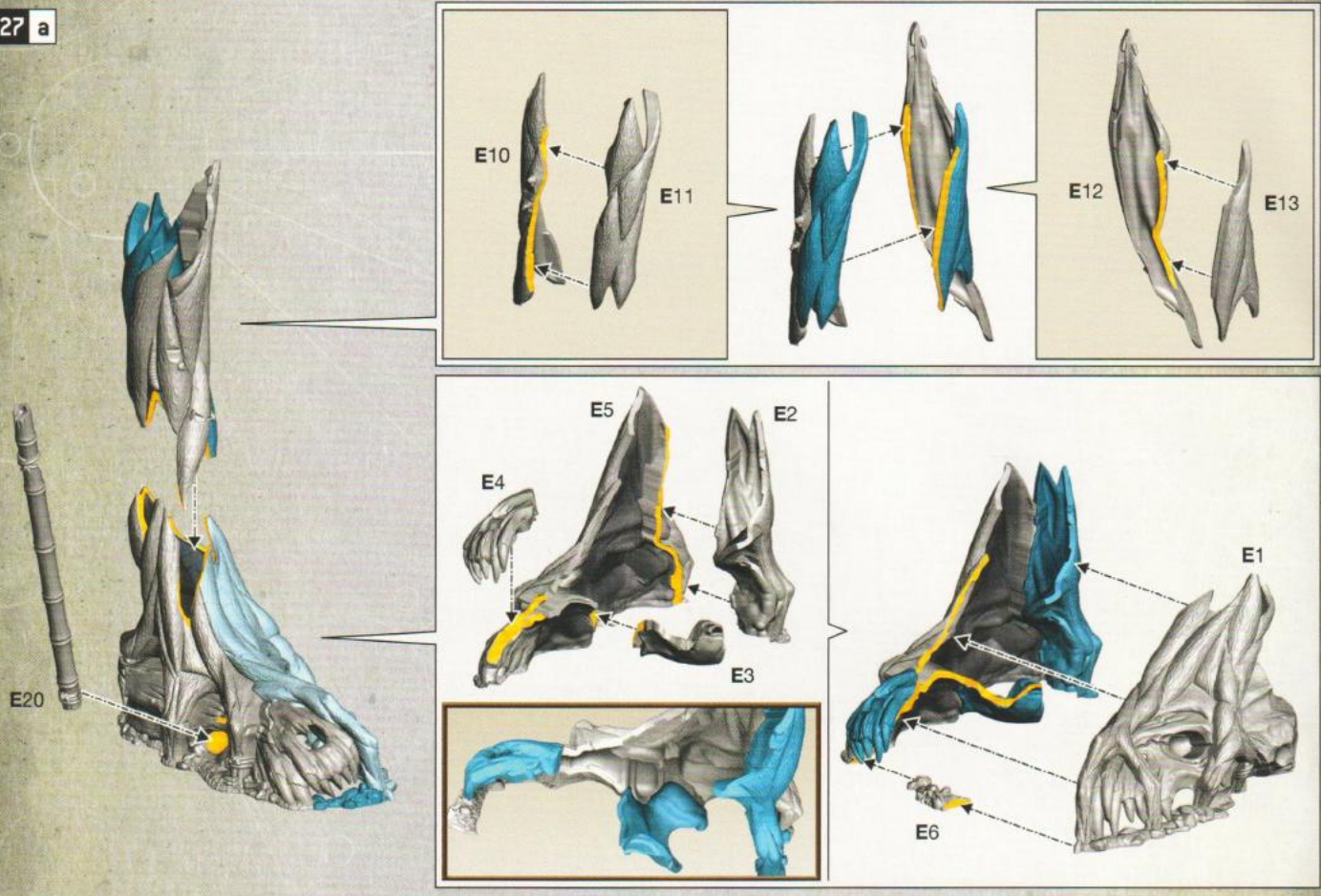

27 b

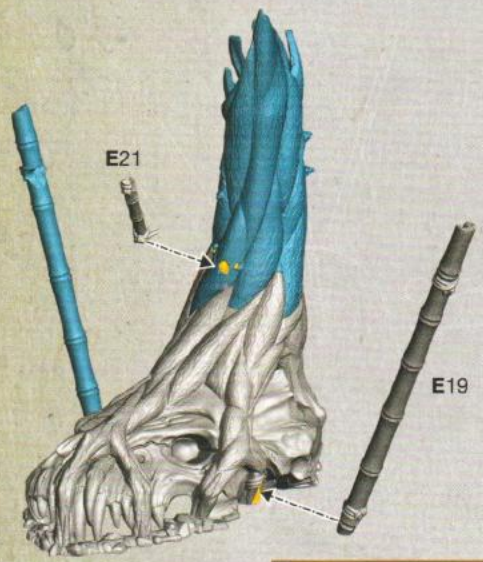

27 a

27 c

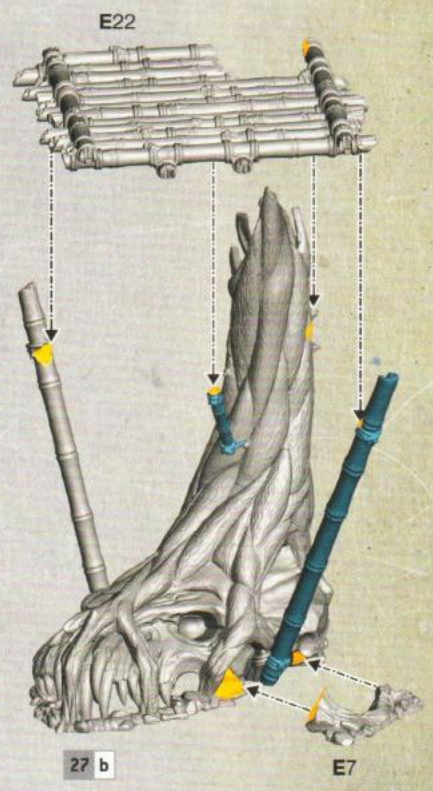

27 b

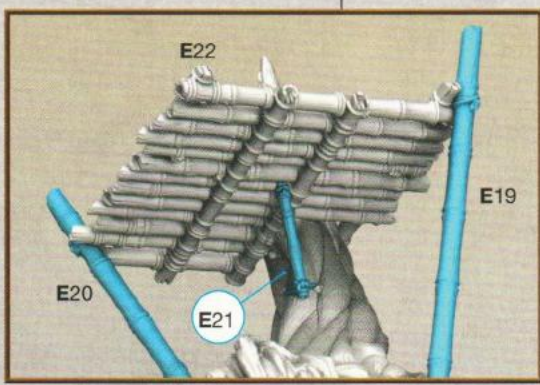

27 d

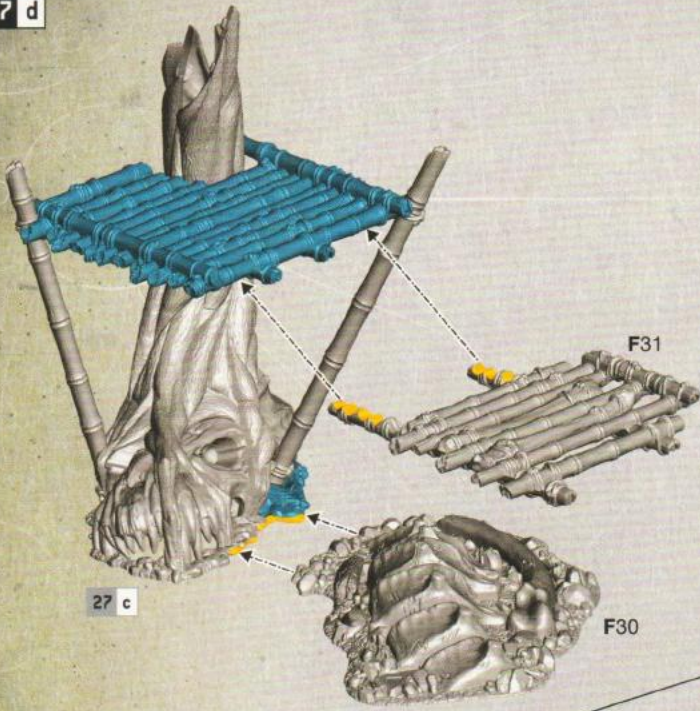

27 e

- ! 1 • Assembly sequence
- Séquence d'Assemblage
- Secuencia de montaje
- 2 • Baureihenfolge
- Sequenza di assemblaggio
- Последовательность сборки
- 組み立て手順
- 拼装顺序

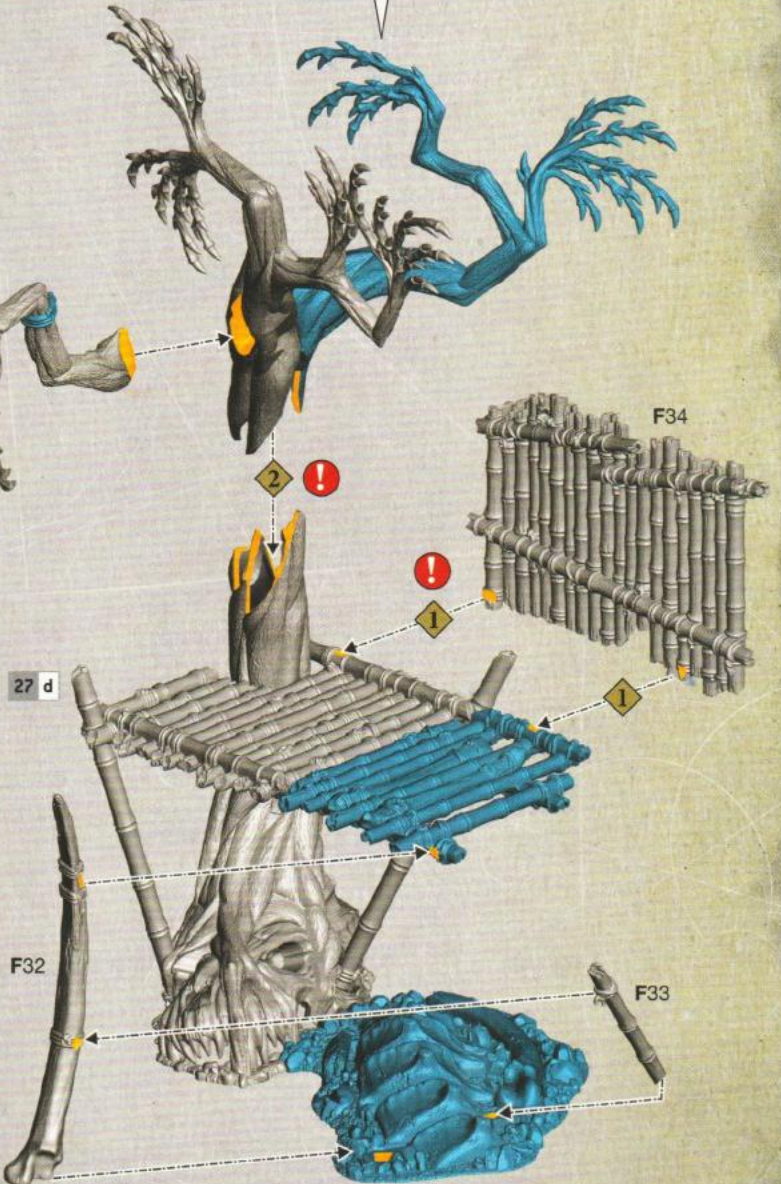
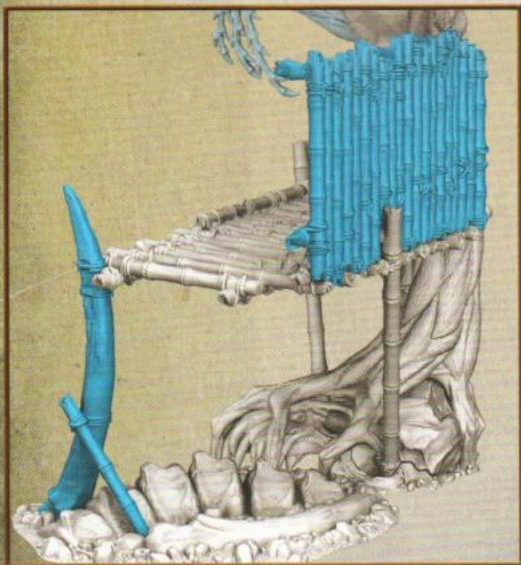
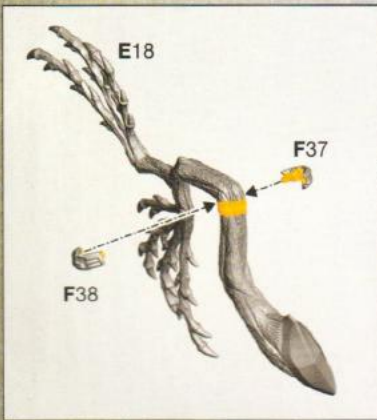

27 f



F36

F35

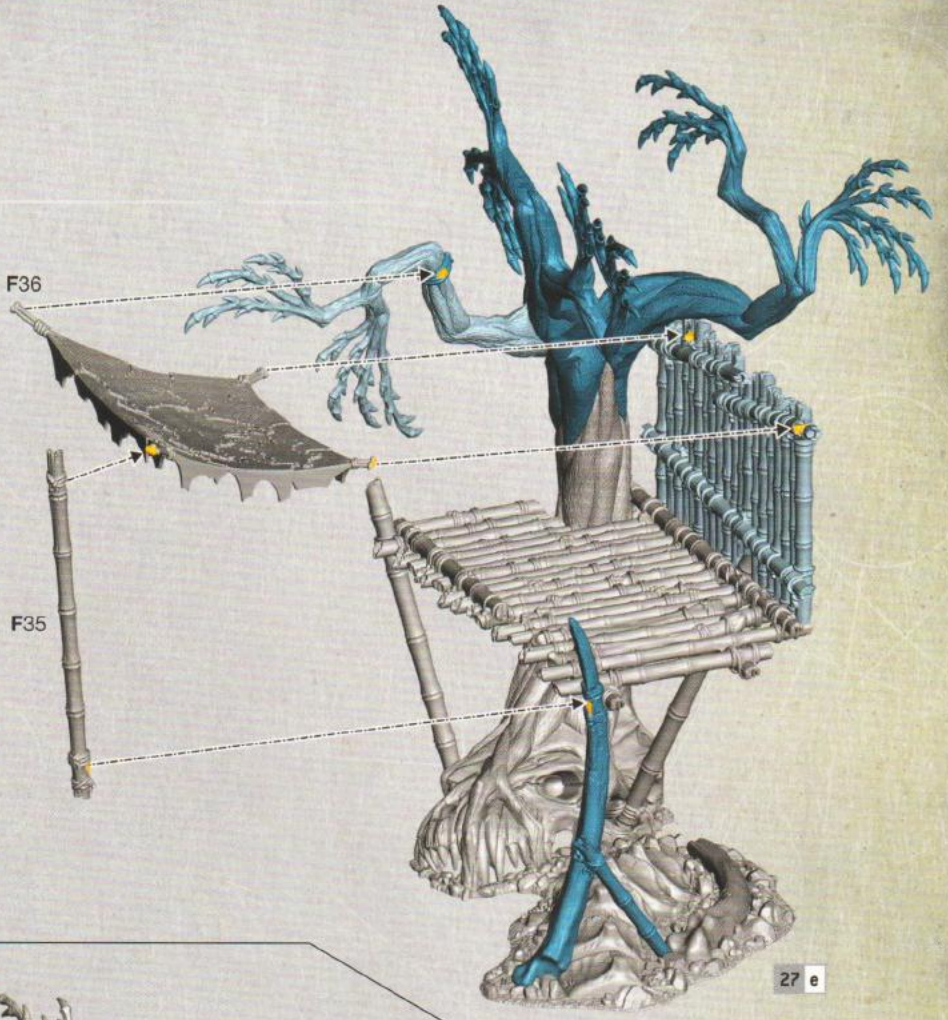

27 e

27 g



27 f



28 a

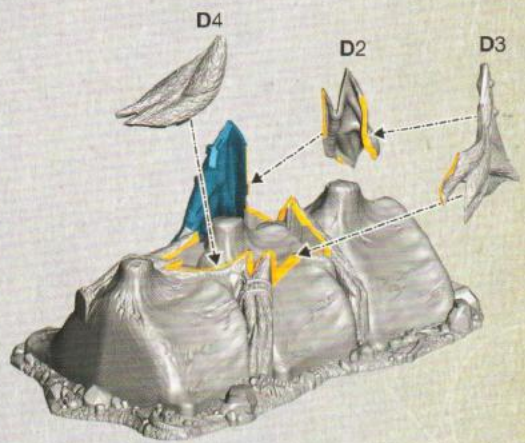
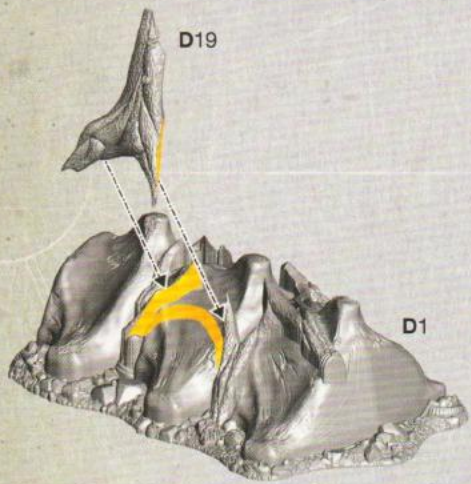

28 b

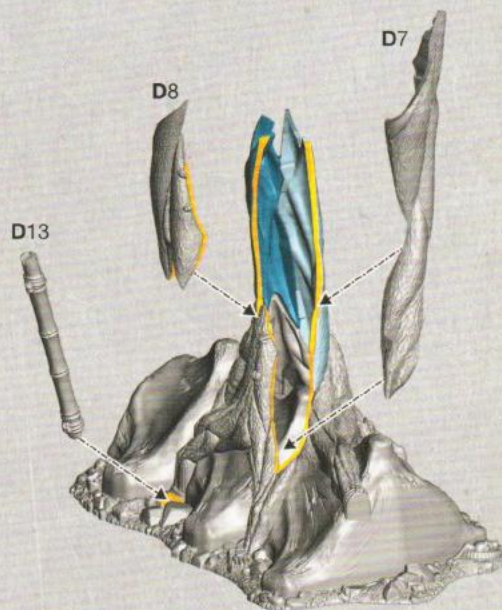
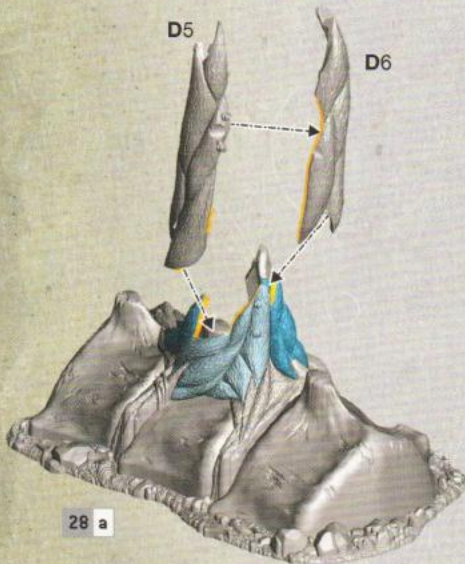

28 c

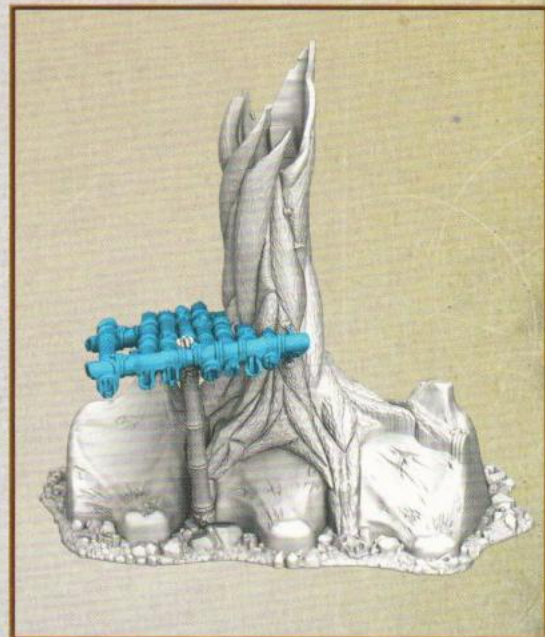
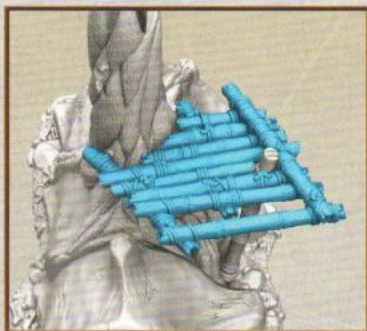
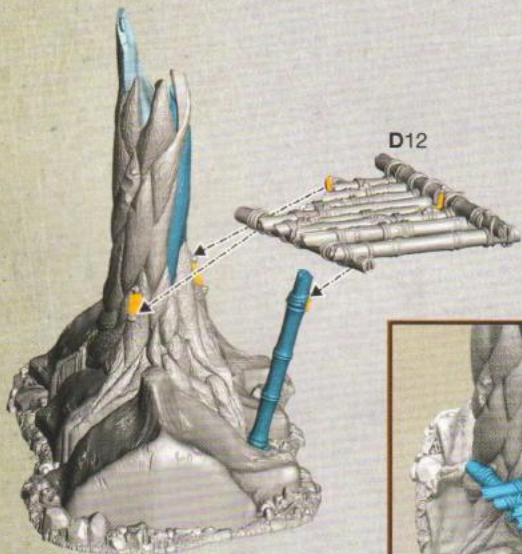



28 d

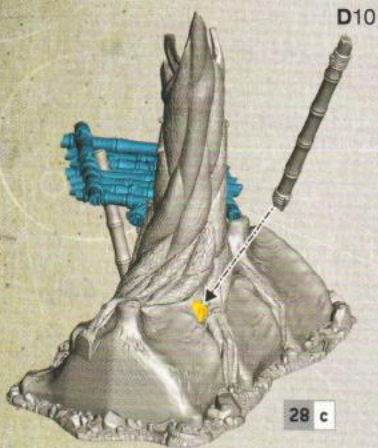

D9

F42



F41

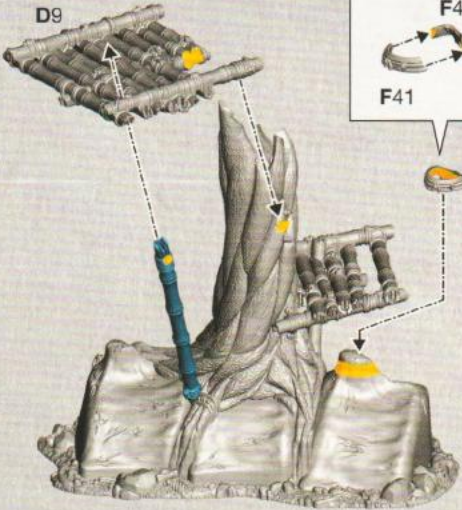

28 e

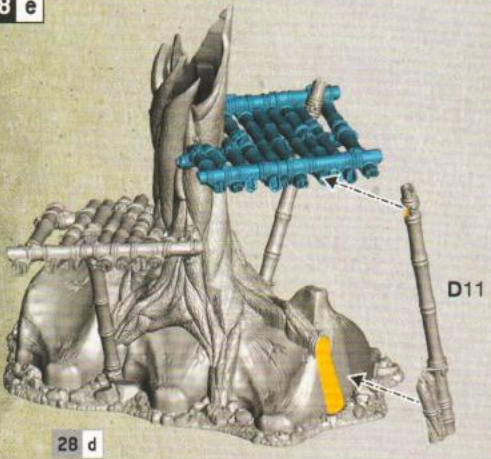

F49

F48

D14

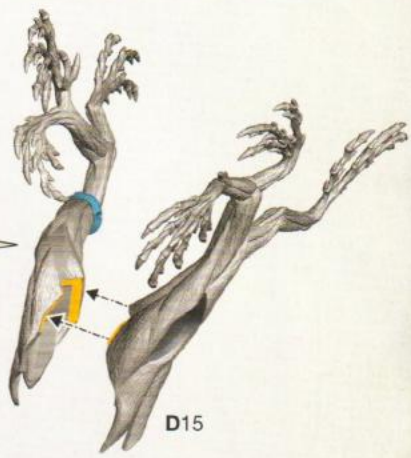
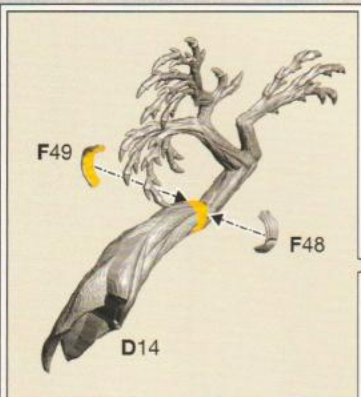

28 f

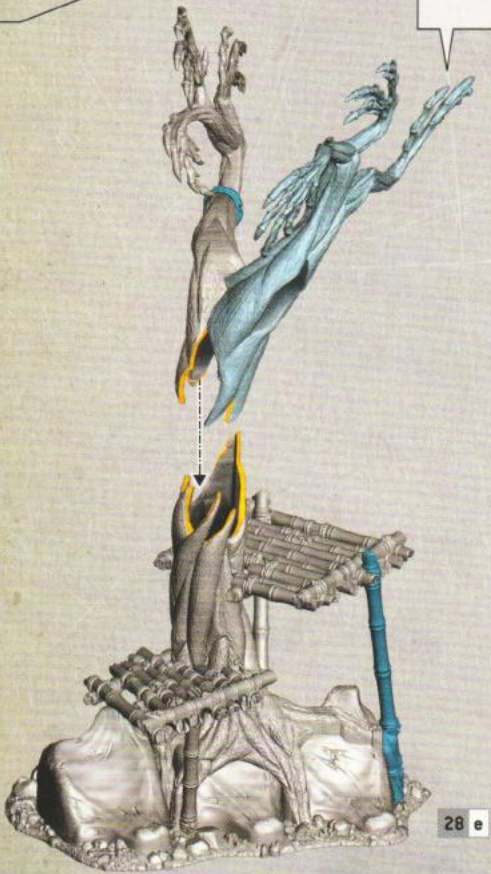

F40

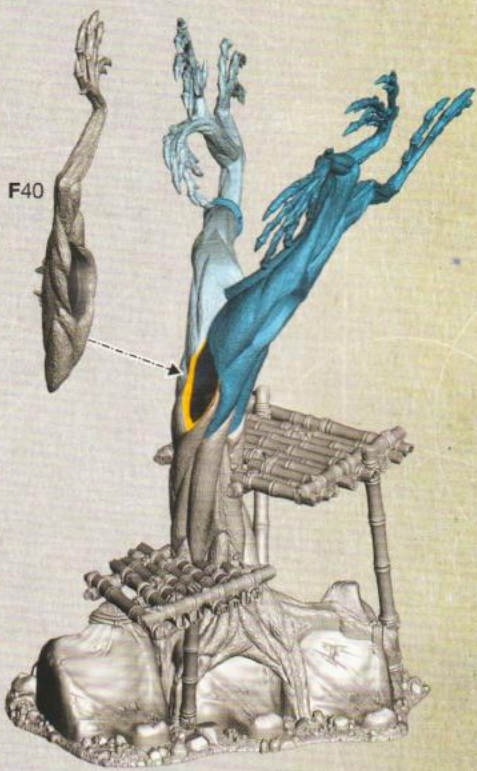

28 g

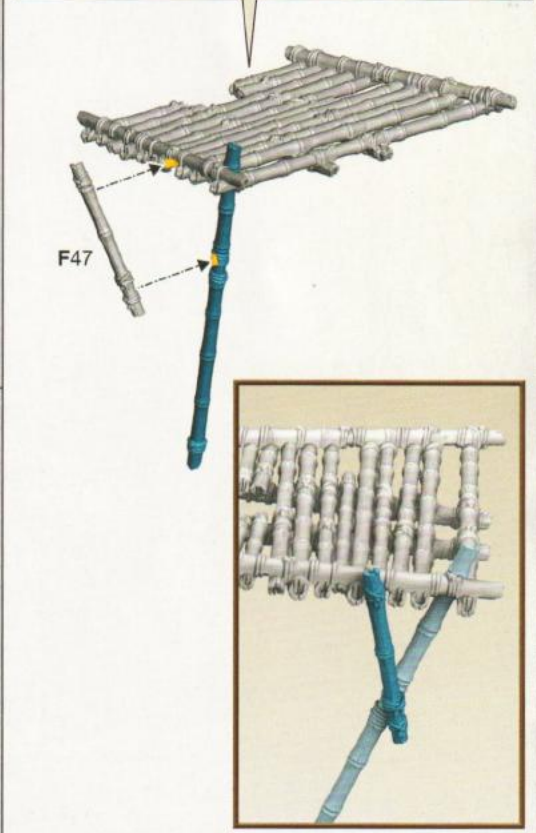
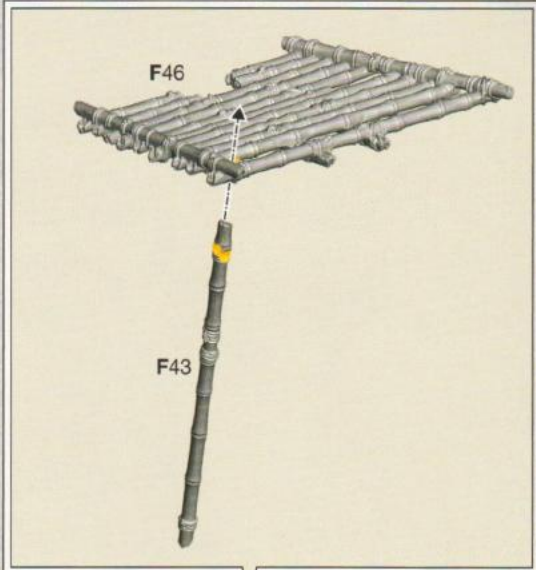
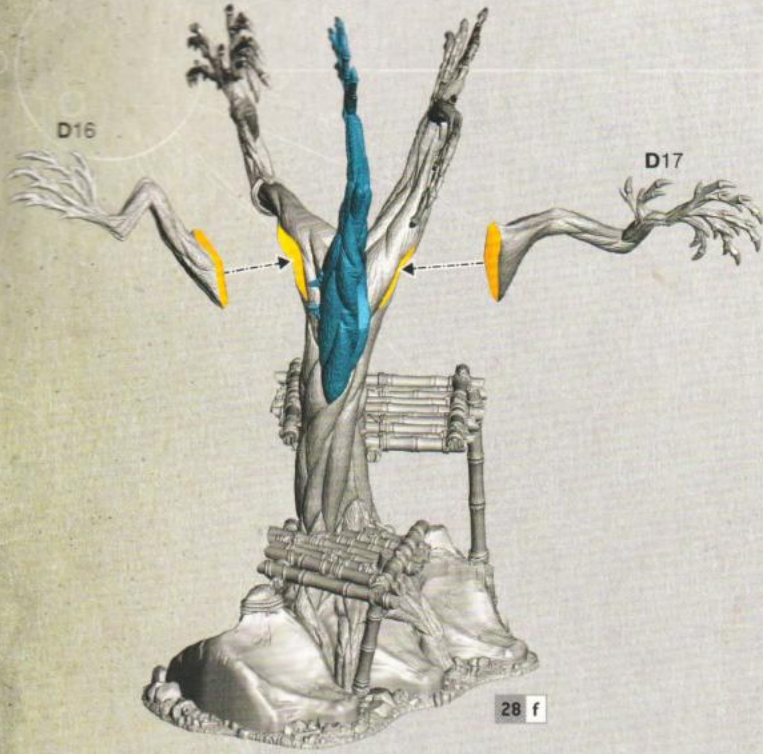

28 h

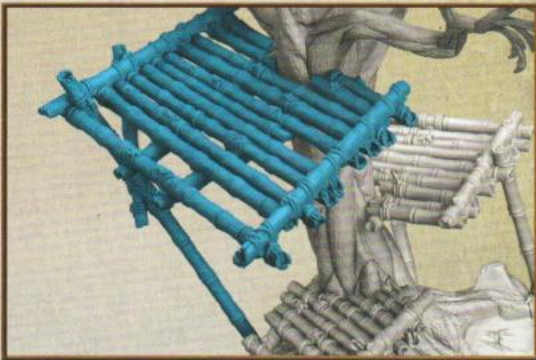

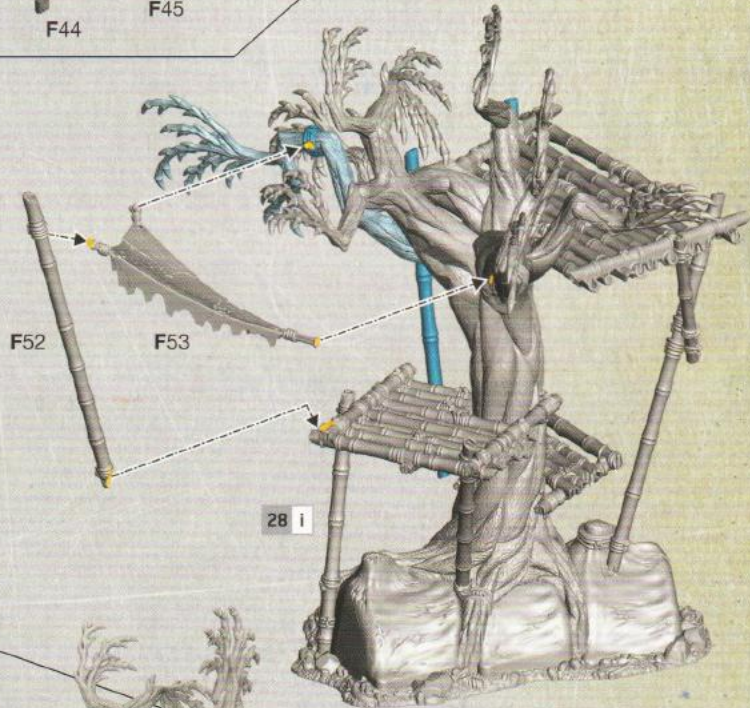
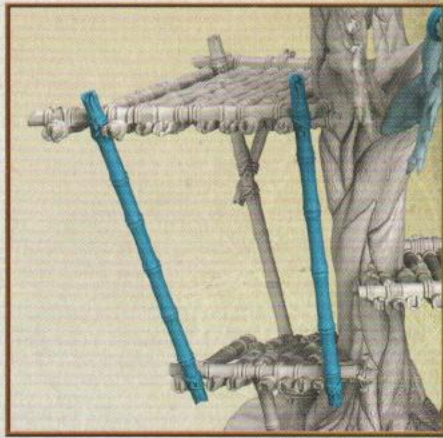
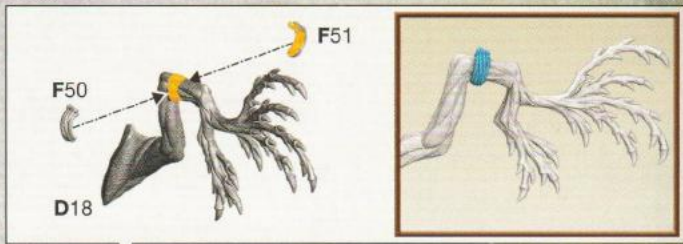

29 a

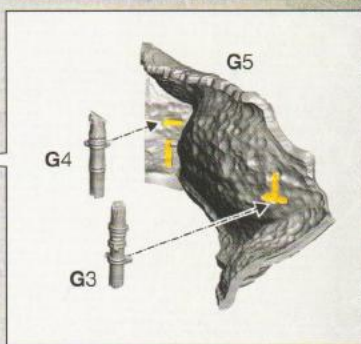
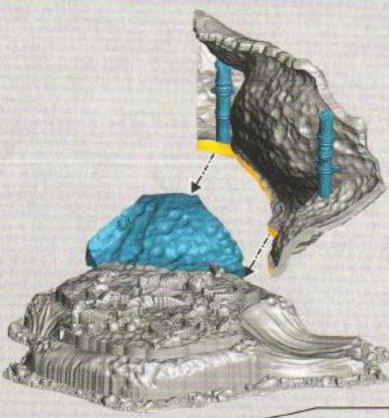
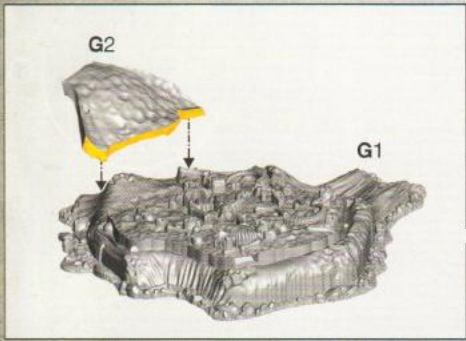

29 b

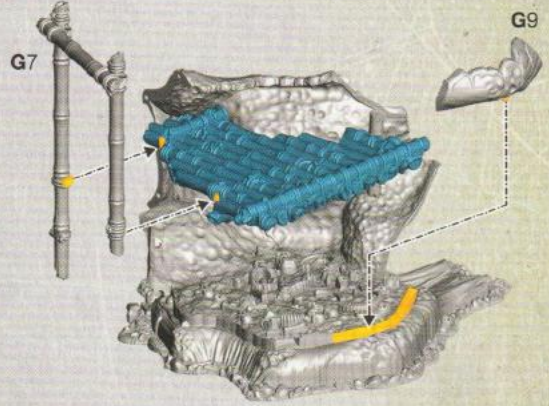
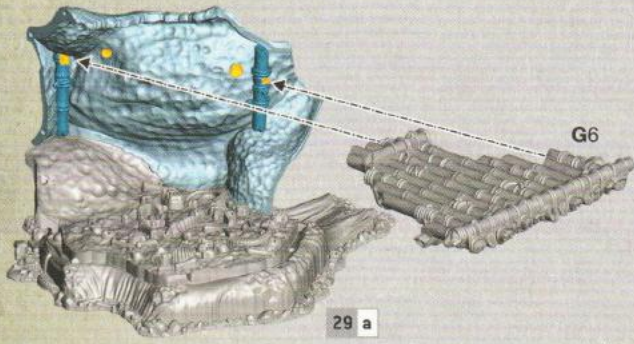

29 c

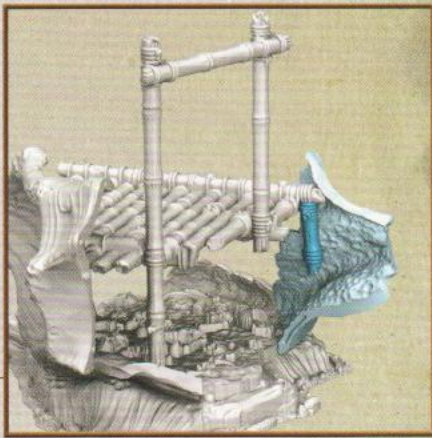
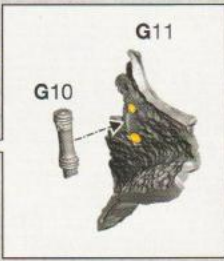
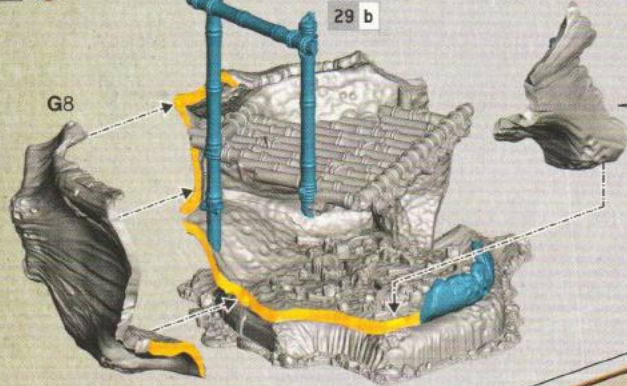

29 d

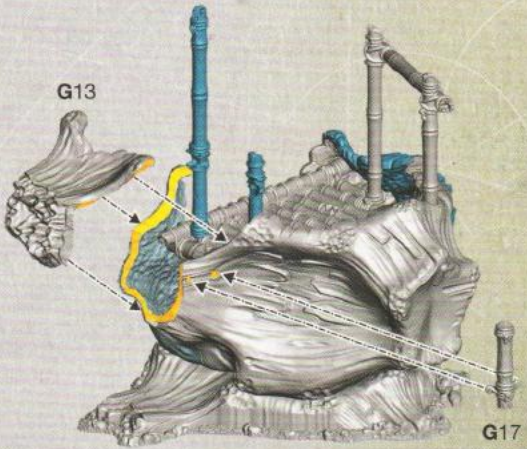
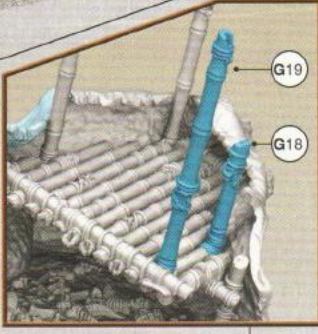
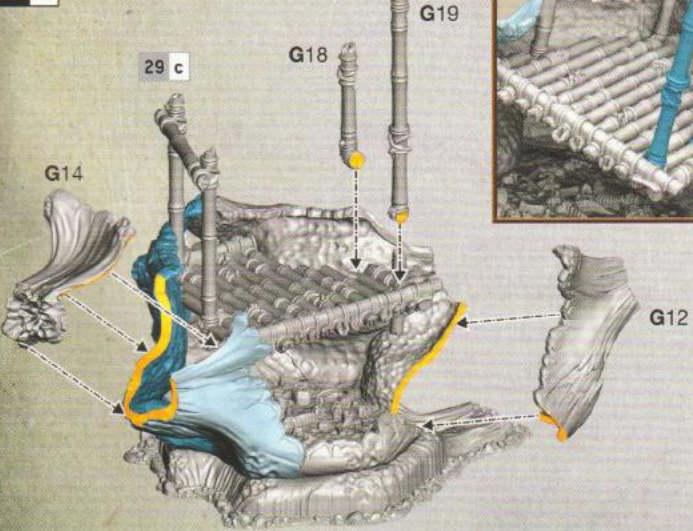

29 e

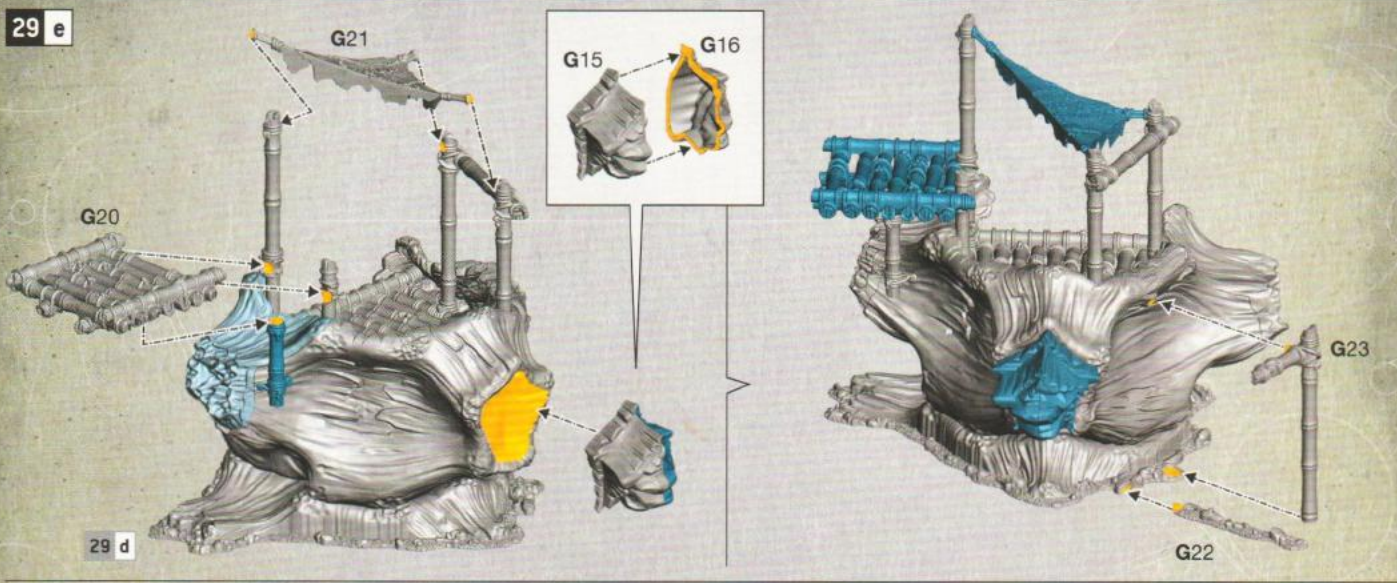

29 f

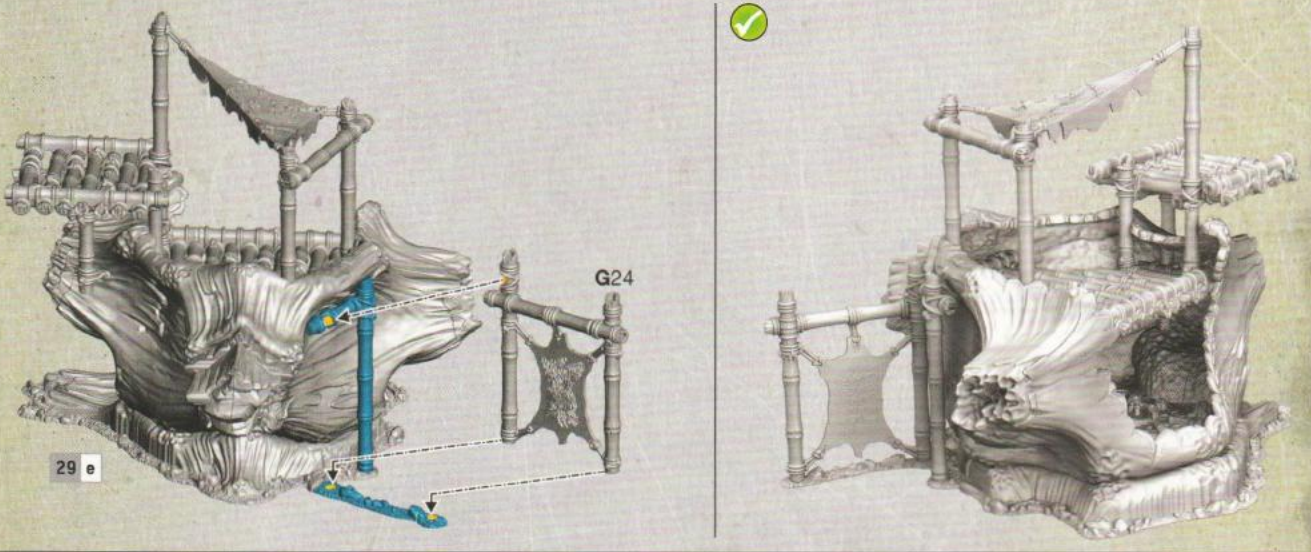

30

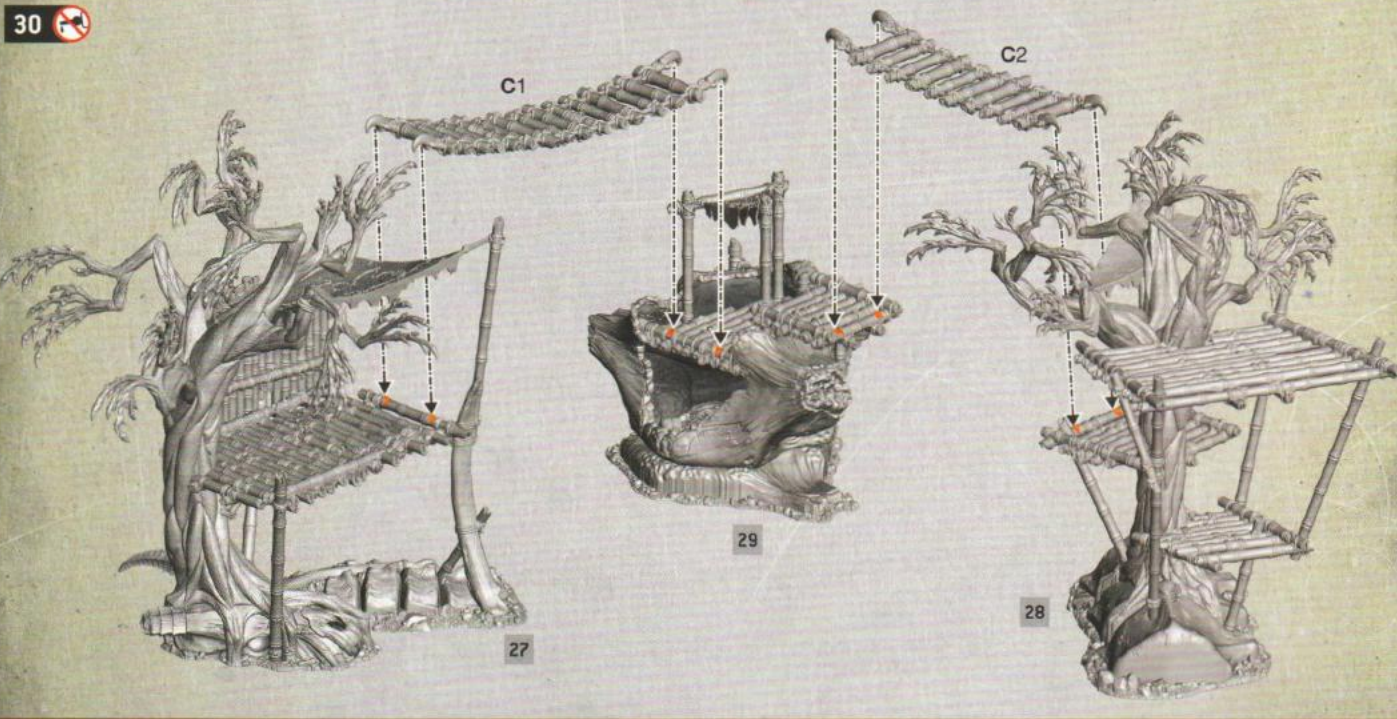

WARHAMMER.COM

Games Workshop Limited, Willow Road, Nottingham, NG7 2WS, UK  
© Copyright Games Workshop Limited 2022.

