



Free Downloads of Build Instructions,
Assembly Booklets & How To Guides

BuildInstructions.com

1

A

CHASSIS & HORSE ASSEMBLY
 ASSEMBLAGE DU CHASSIS ET DES CHEVAUX
 MONTAJE DEL CHASSIS Y EL CABALLO
 ZUSAMMENBAU VON FAHRWERK & PFERDEN
 ASSEMBLAGGIO DI VEICOLI E CAVALLO
 車台と馬の組み立て

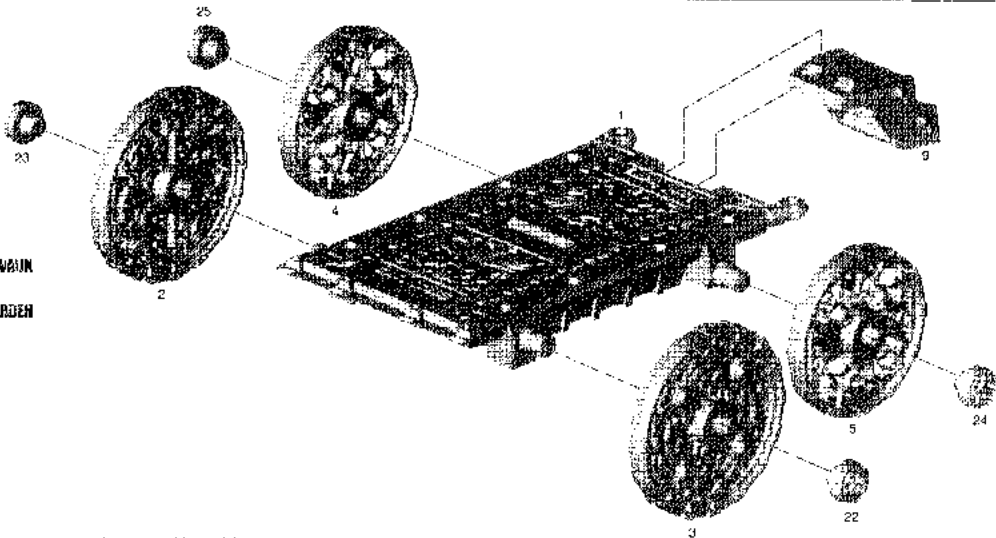

B

Right horse
 Cheval droit
 Caballo derecho
 Rechtes Pferd
 Cavallo di destra
 馬(右)

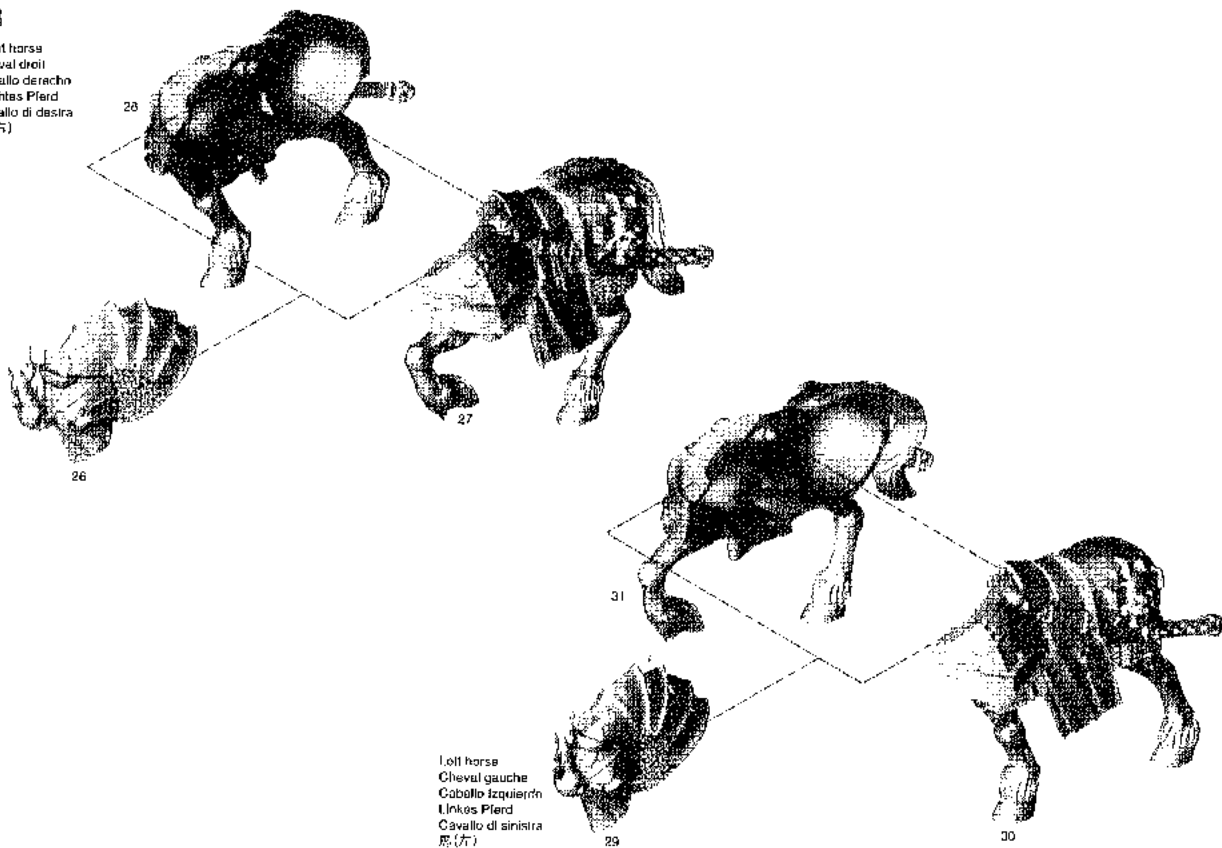

Left horse
 Cheval gauche
 Caballo izquierdo
 Linkes Pferd
 Cavallo di sinistra
 馬(左)

C

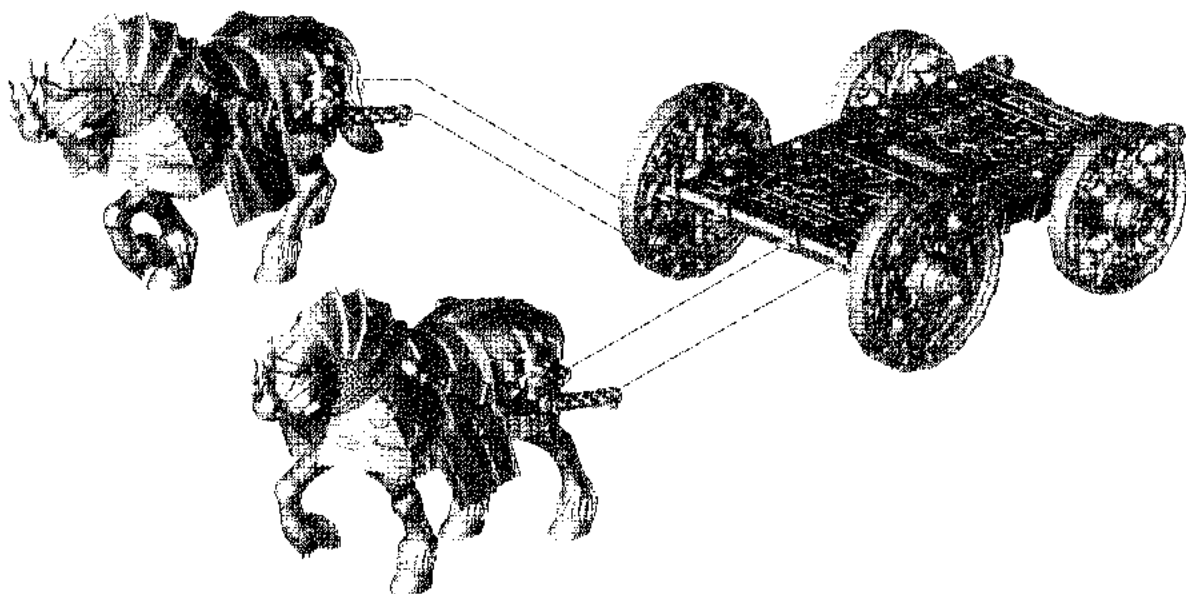

CELESTIA HURACANUM
 HURACANUM CELESTE
 HURACANUM CELESTIAL
 CELESTISCHES ORKANUM
 VORTICANUM CELESTE
 セレスティアル・ハリケイナム

Follow stages 1 to 6
 Suivre les étapes 1 à 6
 Sigue los pasos 1 a 6
 Schritte 1 bis 6
 Segui le fasi dalla 1 alla 6
 ステップ1から6に従う

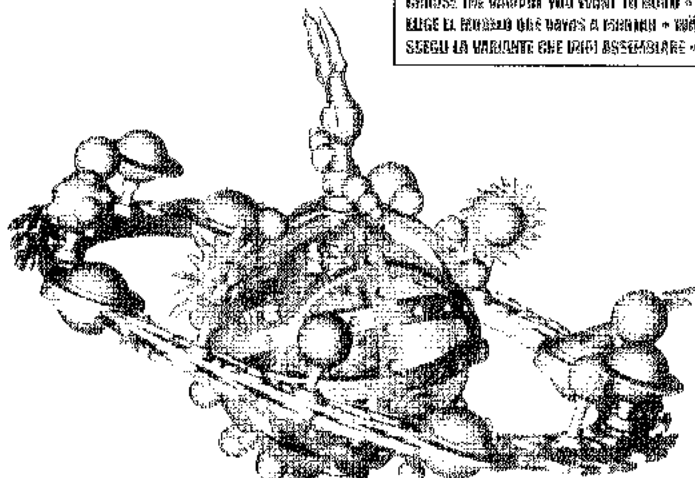

CHOOSE THE VARIANT YOU WANT TO BUILD • CHOISISSEZ LA VARIANTE À ASSEMBLER
 ELIGE EL MODELO QUE DEVAS A ARMAR • ESCOGE LA VARIANTE DE QUERER MONTAR
 SEGUI LA VARIANTA CHE DEVI ASSEMBLARE • 組み立てたい方のミニチュアを選択する

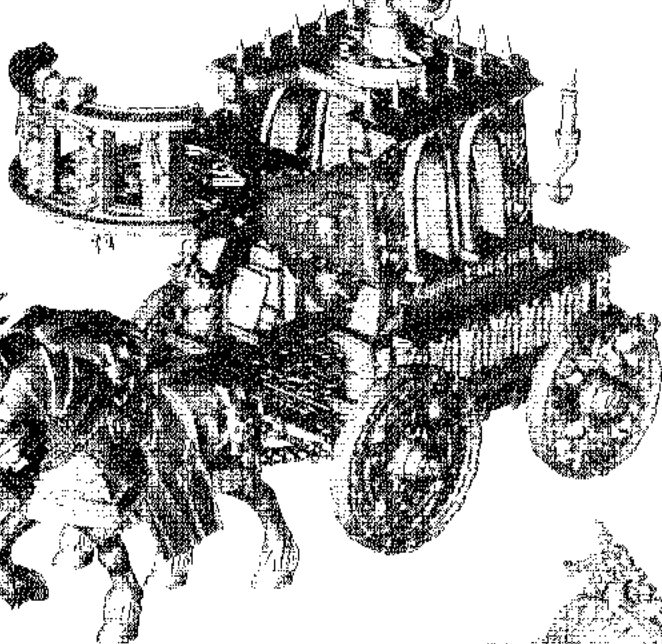

LUMINARUM OV HYSH
 HORNOSUS DE HYSH
 LURNARCA DE HYSH
 LURNARCA DE HYSH
 LURNARCA DE HYSH
 ルミナーク・オヴ・ハイシュ

Follow stages 7 to 12
 Suivre les étapes 7 à 12
 Sigue los pasos 7 a 12
 Schritte 7 bis 12
 Segui le fasi dalla 7 alla 12
 ステップ7から12に従う

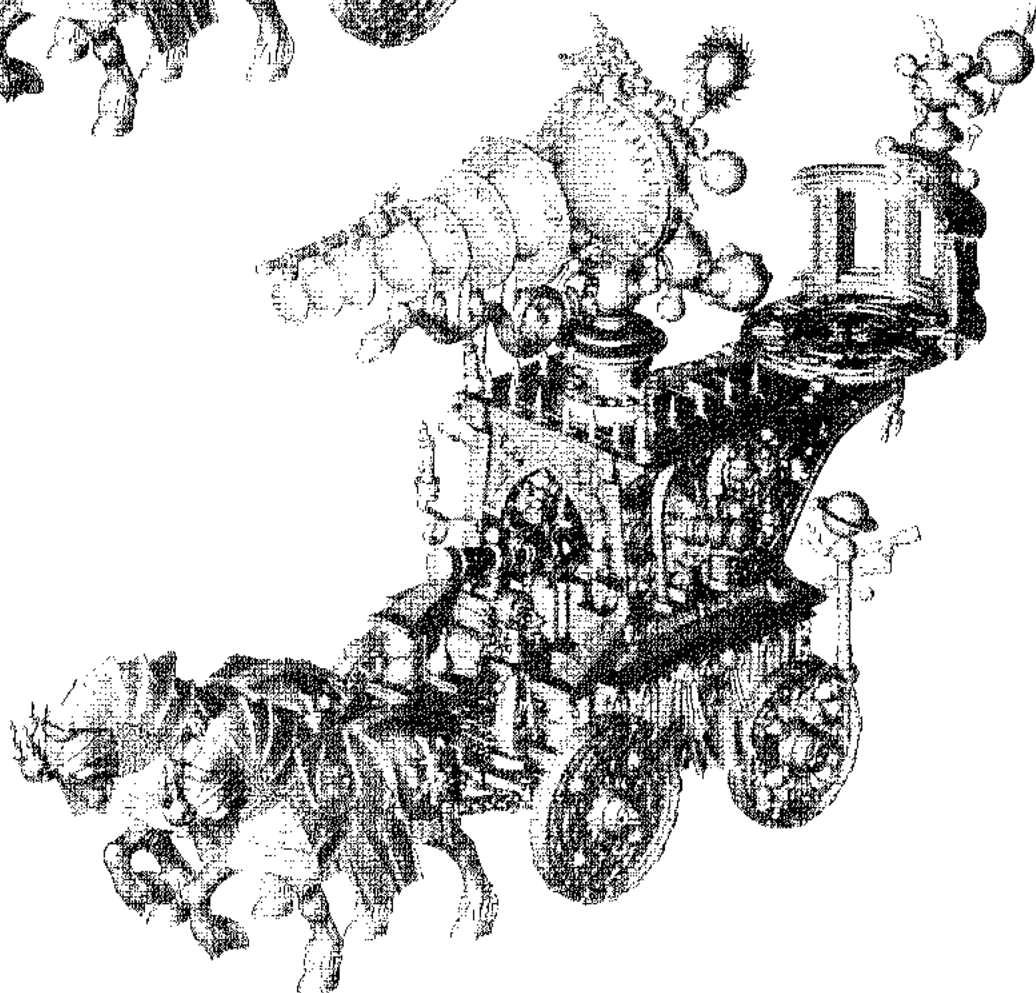

1 FULL ASSEMBLY • ASSEMBLAGE DE LA CASSE • MONTAGE DEL CASCO
ZUSAMMENBAU DES KÄFFERS • ASSEMBLAGGIO DELLA STRUTTURA • 車体の組み立て

CELESTIAL MECHANISMS • MECCANISMO CELESTE • MASHINARUMI KAKUSHUKU
MITSUKANETSU ORGANIZU • MONTAGGIAMO CASSA • セレスティアル・ハリケイツム

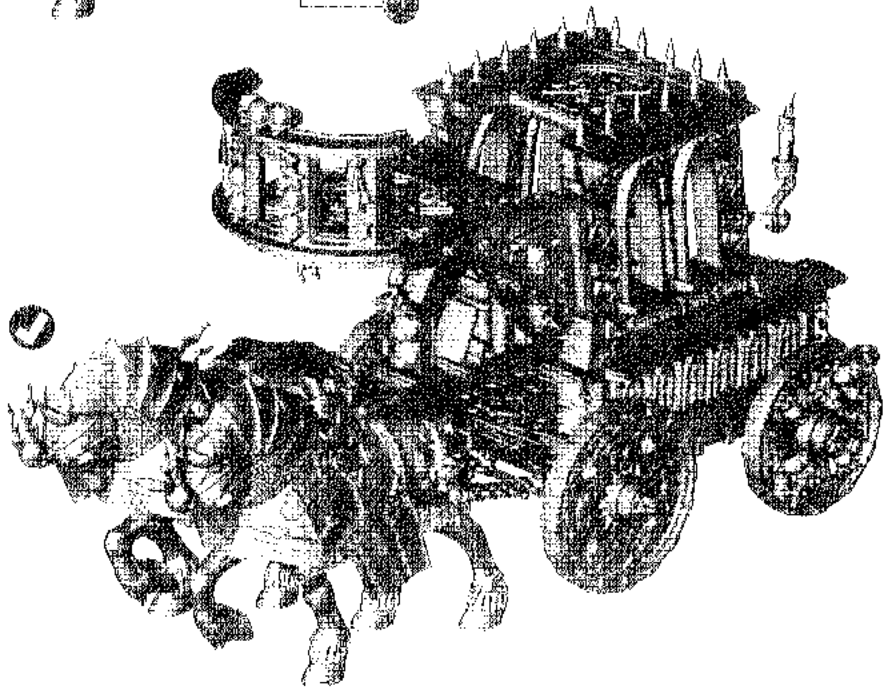
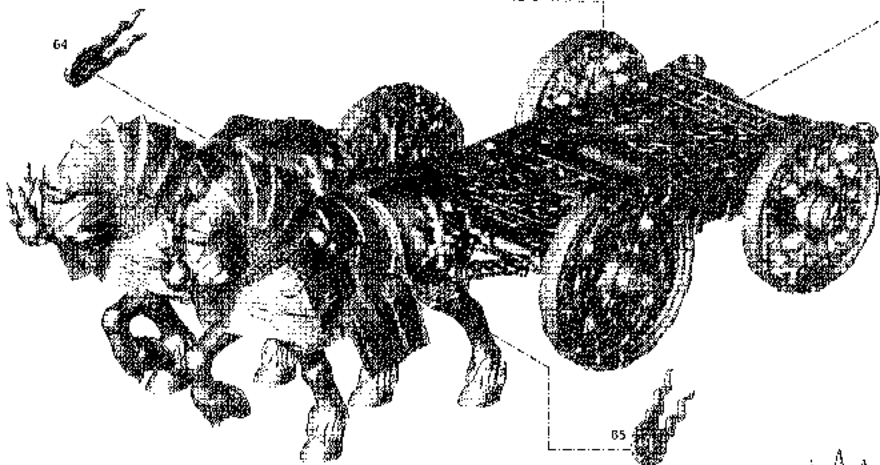
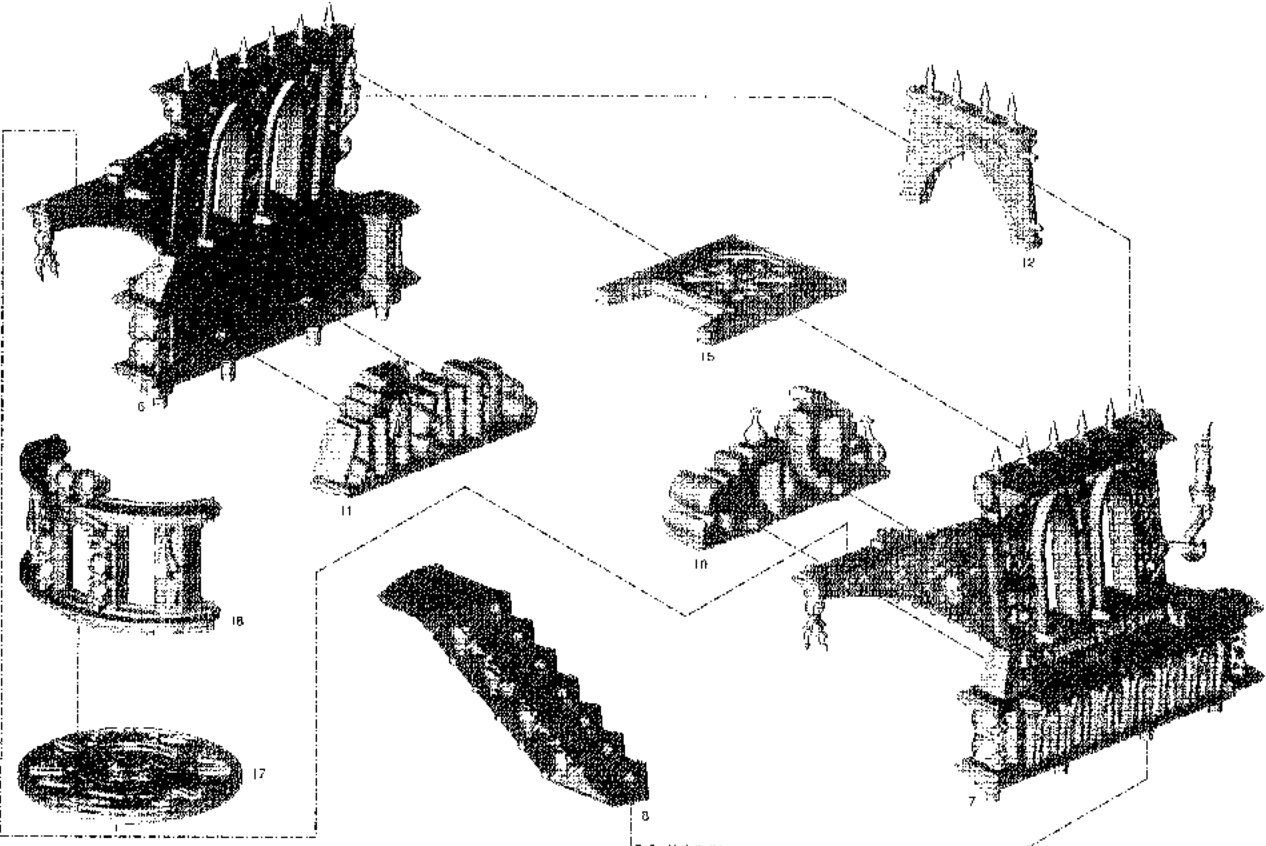

2

HARICANUM ASSEMBLY • ASSEMBLAGE DE L'HARICANUM • MONTAGE DEL HARICANUM
ZISAMBAWABU DES CHAMBERS • ASSEMBLAGGIO DEL HARICANUM • ハリケイナムの組み立て

A

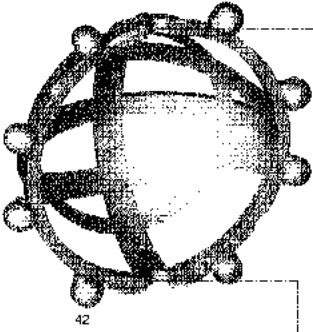

42



46

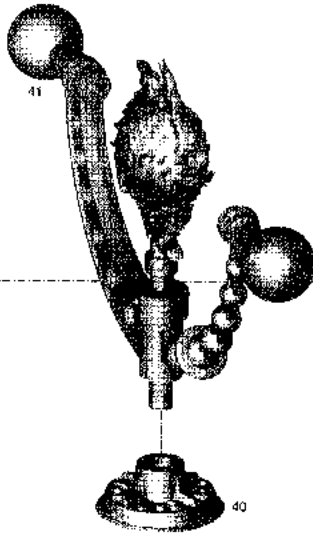

41

40

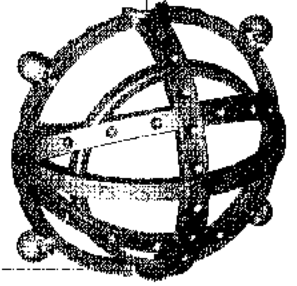

45

B

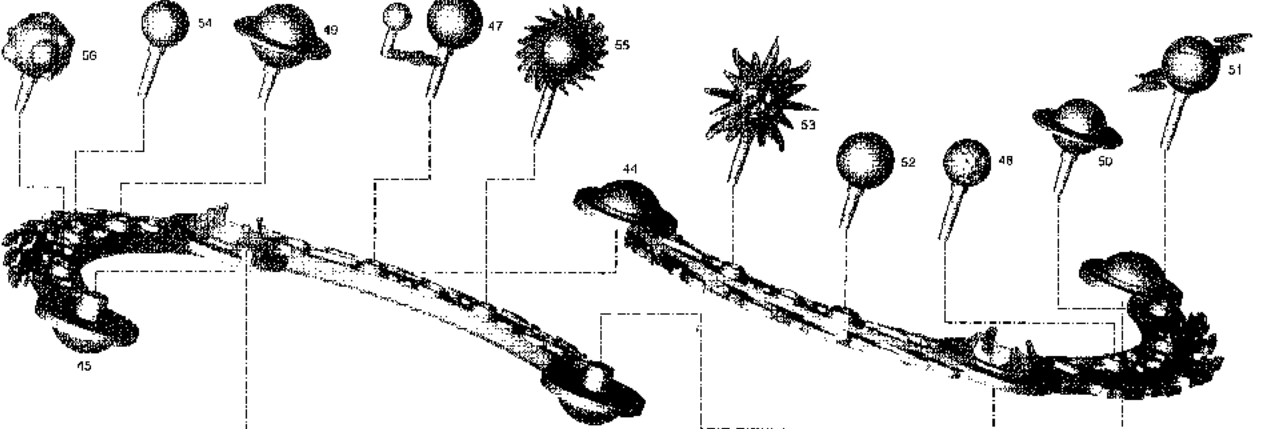

44

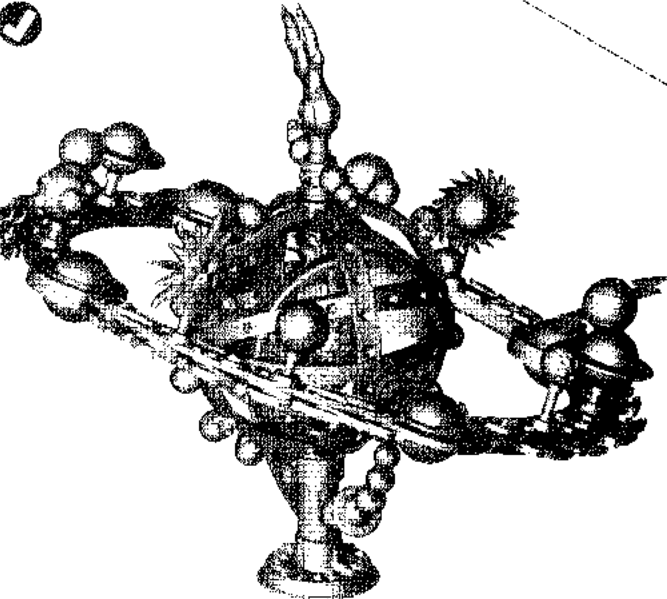

43

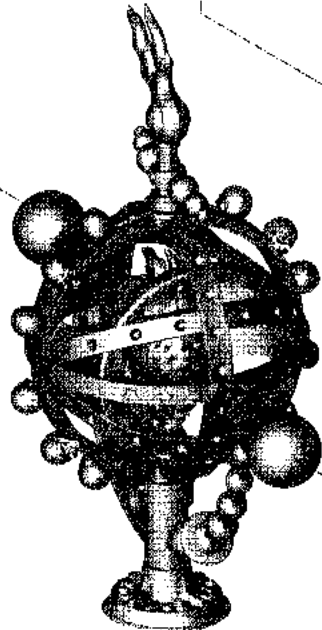

3

MODERNISM TO FINI ASSARBY • ASSOCIARE LE FIGURAZIONI A LA CORRE
MONTA DI RORCHESI AL CASCH • ASSOCIARE UNO SPERARE UNO RUMI
RESEMBLANZA DEL GORRORUM PIA SINTETICA • ハリケイナムと空体の組み立て

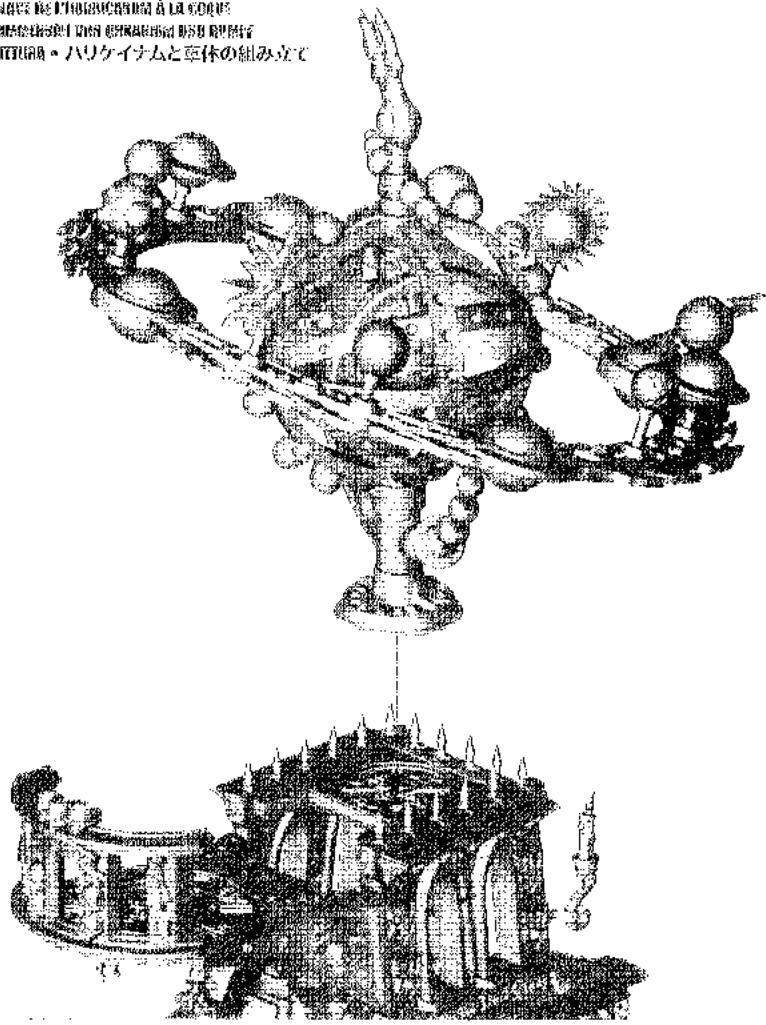

4

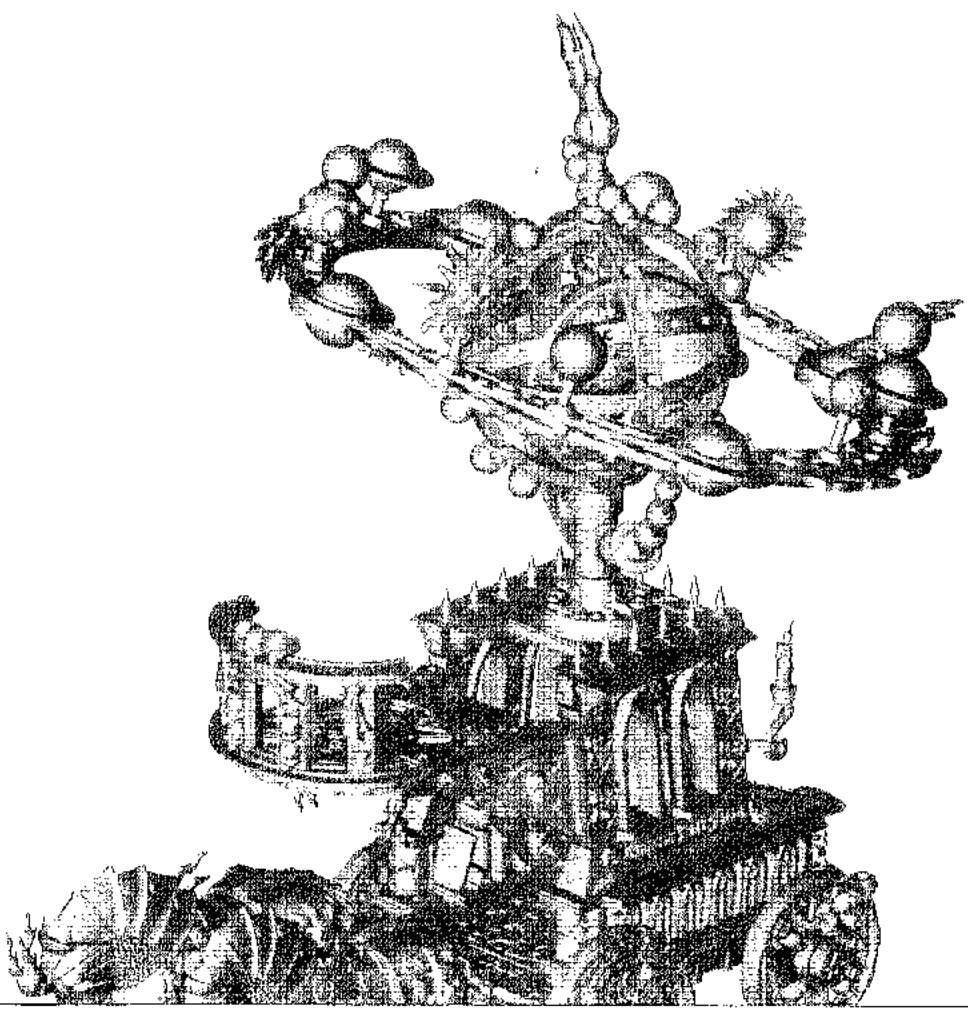

THE CELESTIAL MINDSCRAMBLER CAN BE ASSEMBLED WITH 2 ACOLITES OR A WIZARD LORD AND 1 ACOLYTE. WIZARD LORD ASSEMBLY IS STAGE 3, ACOLYTE ASSEMBLY IS STAGE 5.

L'INSTRUMENT MENTALISME PEUT ÊTRE ASSEMBLÉ AVEC 2 ACOLITES, OU 1 SORCIER CÉLESTE ET 1 ACOLYTE. POUR L'ASSEMBLAGE DU SORCIER CÉLESTE, VOIR ÉTAPE 4. POUR L'ASSEMBLAGE DE L'ACOLYTE, VOIR ÉTAPE 5.

IL MENTALISME CELESTIAL PUÒDE MONTARSI CON 2 ACOLITOS O CON UN MESTERZO MAYOR Y 1 ACOLITO. EL MONTAR DE MESTERZO MAYOR ESTÁ EN EL PASO 4, Y EL DE ACOLITO EN EL PASO 5.

DAS CELESTISCHE GEMÄNDER KÖNN MIT 2 AKOLYTHEN ODER MIT MESTERZLEITER UND 1 AKOLYTHEN GEBAUT WERDEN. SCHRITT 4 BESCHREIBT DEN ZUSAMMENBAU DES MESTERZLEITERS, SCHRITT 5 DEN DER AKOLYTHEN.

IL MENTALISME CELESTE POU ÊTRE ASSEMBLÉ AVEC 2 ACOLITES O AVEC UN ASCRIBO ET 1 ACOLITE. PER L'ASSEMBLAGE DELL'ASCRIBO VEDI LA PAG. 4, PER QUELLO DELL'ACOLITO VEDI LA PAG. 5.

アコライト2人にするか、ウィザードロード1人とアコライト1人にするかを選択して、セレスティアル・ハリケイナムを組み立てる。ウィザードロードの組み立てはステップ4、アコライトの組み立てはステップ5に従うこと。

4

A

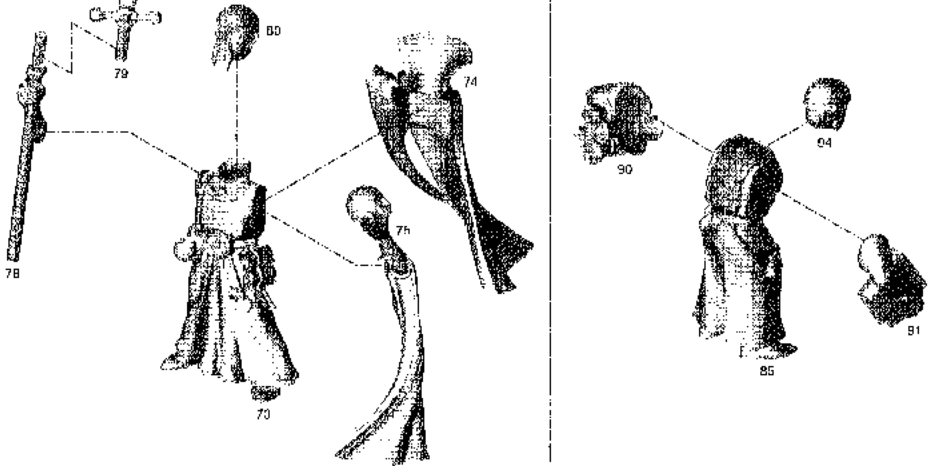

B

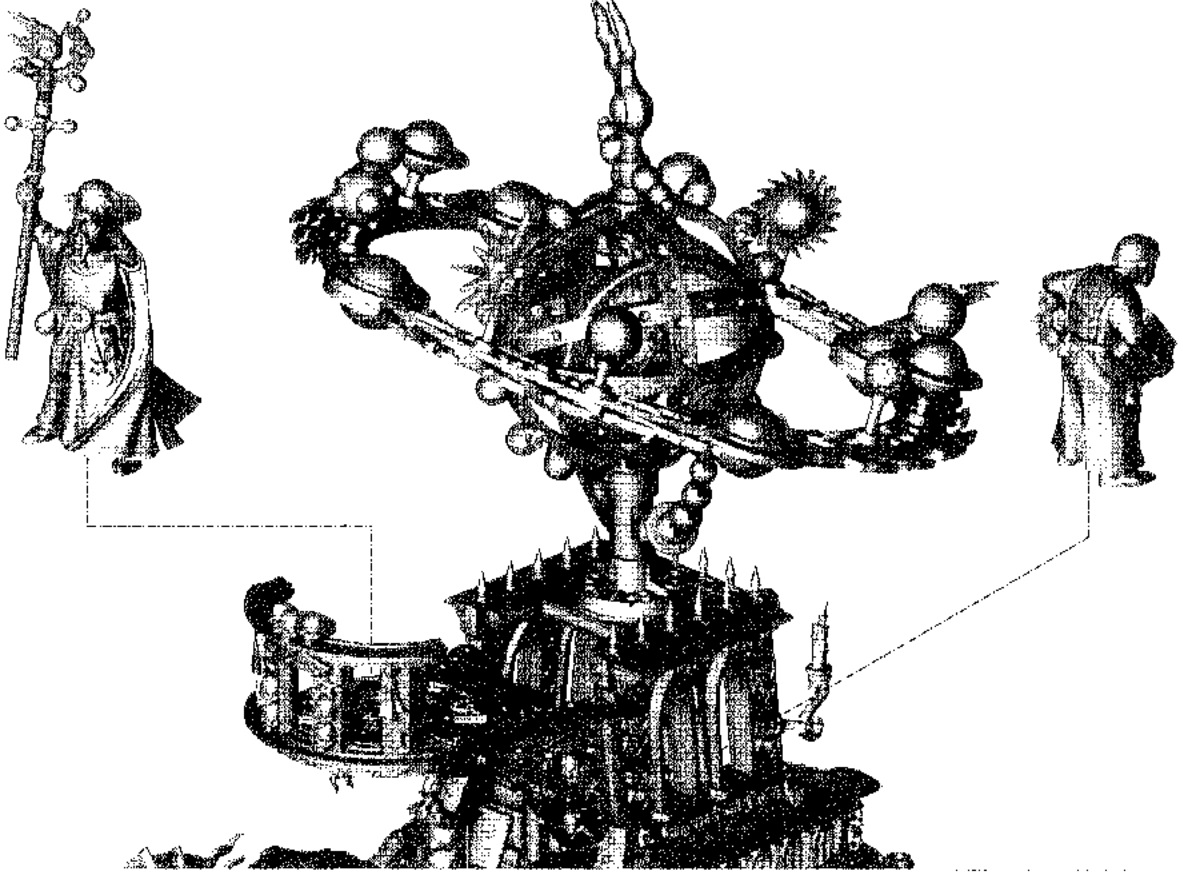

✓

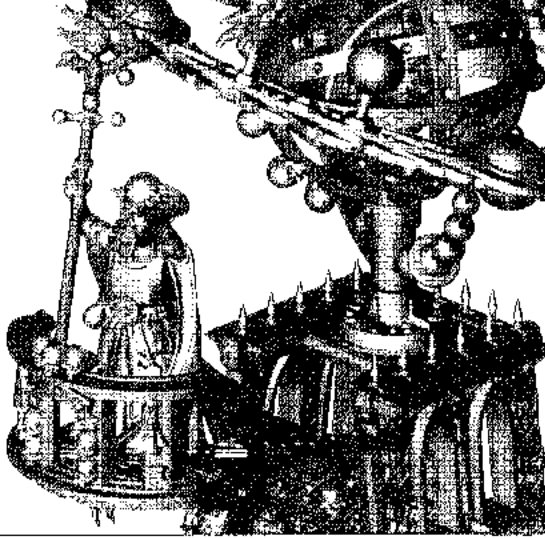

✓

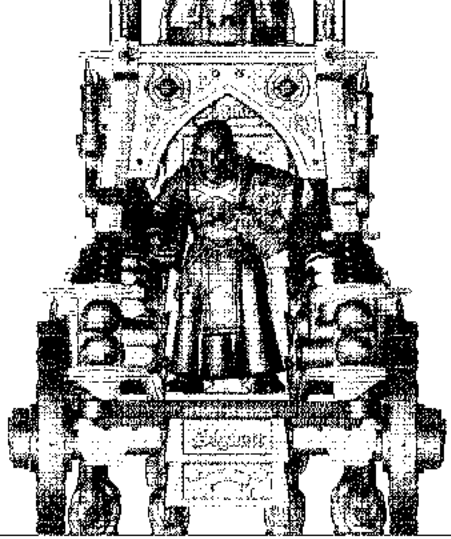

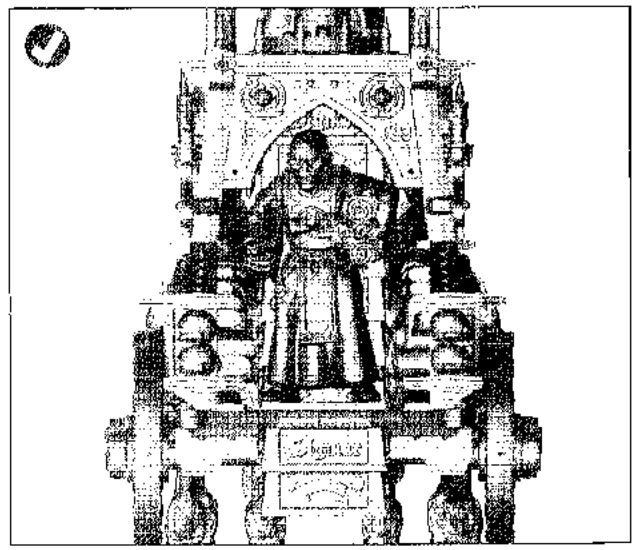
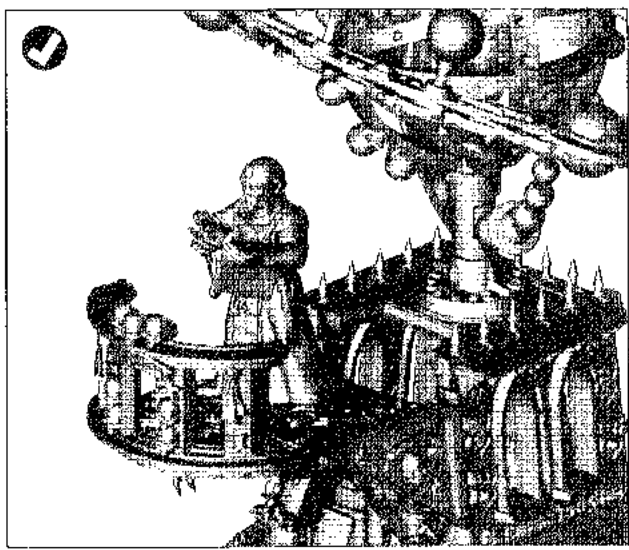
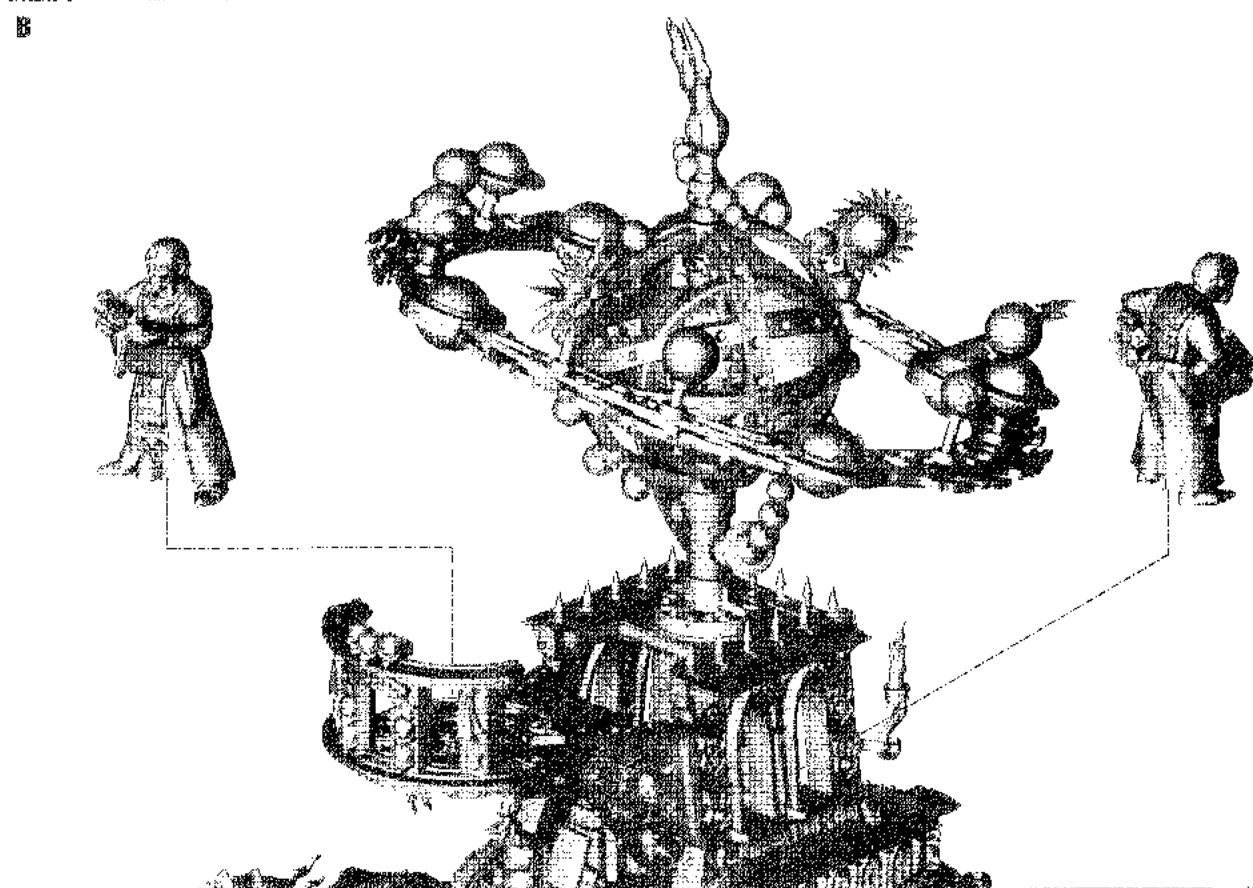
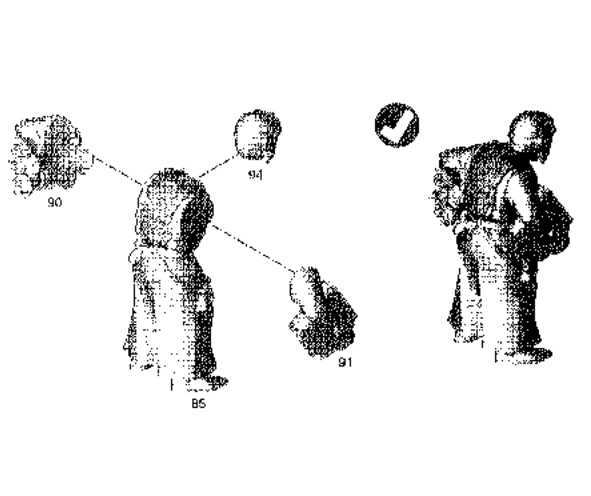
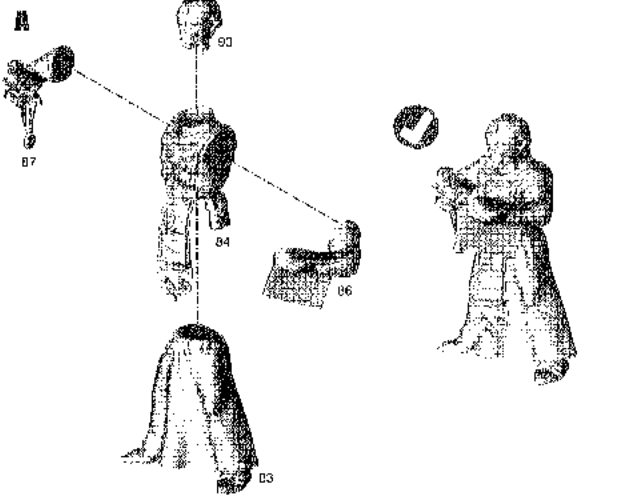

6

CELESTIAL MURAGANAMA EXTRAS
EXTRAS DEL MURAGANAMA CELESTIAL
ZUBEHÖRER DES CELESTISCHEN MURAGANAMA
EXTRA DEL MURAGANAMA CELESTE
セレスティアル・ハリケインムのオプションパーツ

Extras can be placed anywhere. Below is just one example.
 Ces extras peuvent être disposées à votre guise. Voici quelques exemples.
 Los extras pueden situarse en cualquier parte. El do abajo es solo un ejemplo.
 Zubehörteile können beliebig angebracht werden. Hier sehenst du nur ein mögliches Beispiel.
 Gli extra possono essere collocati ovunque, qui sotto è mostrato un esempio.
 オプションパーツは好きな場所に貼り付けられる。下写真はその一例だ。

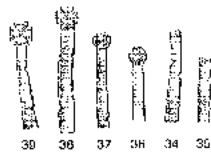

Sea's
 Scaux
 Seltos
 Siepa'
 Sigilli
 ETC

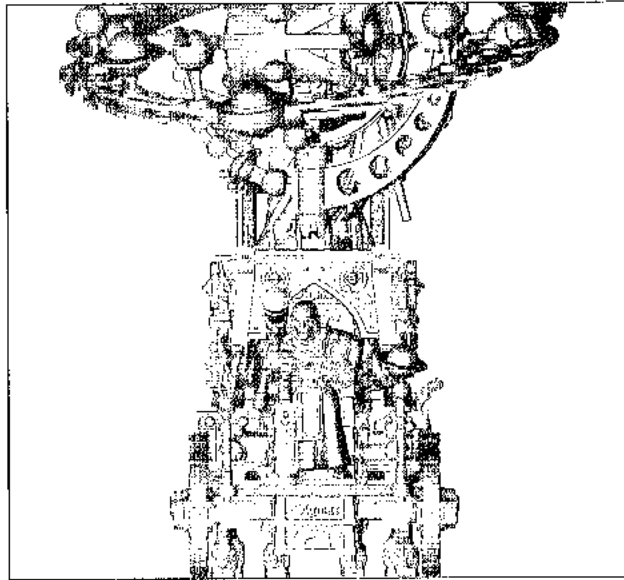
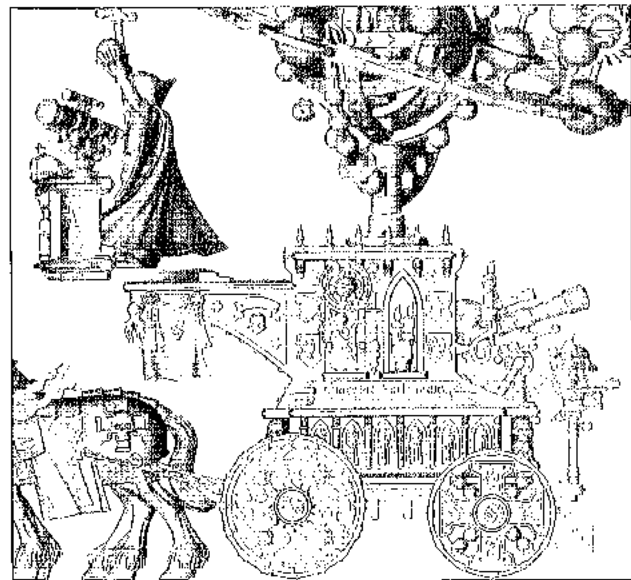
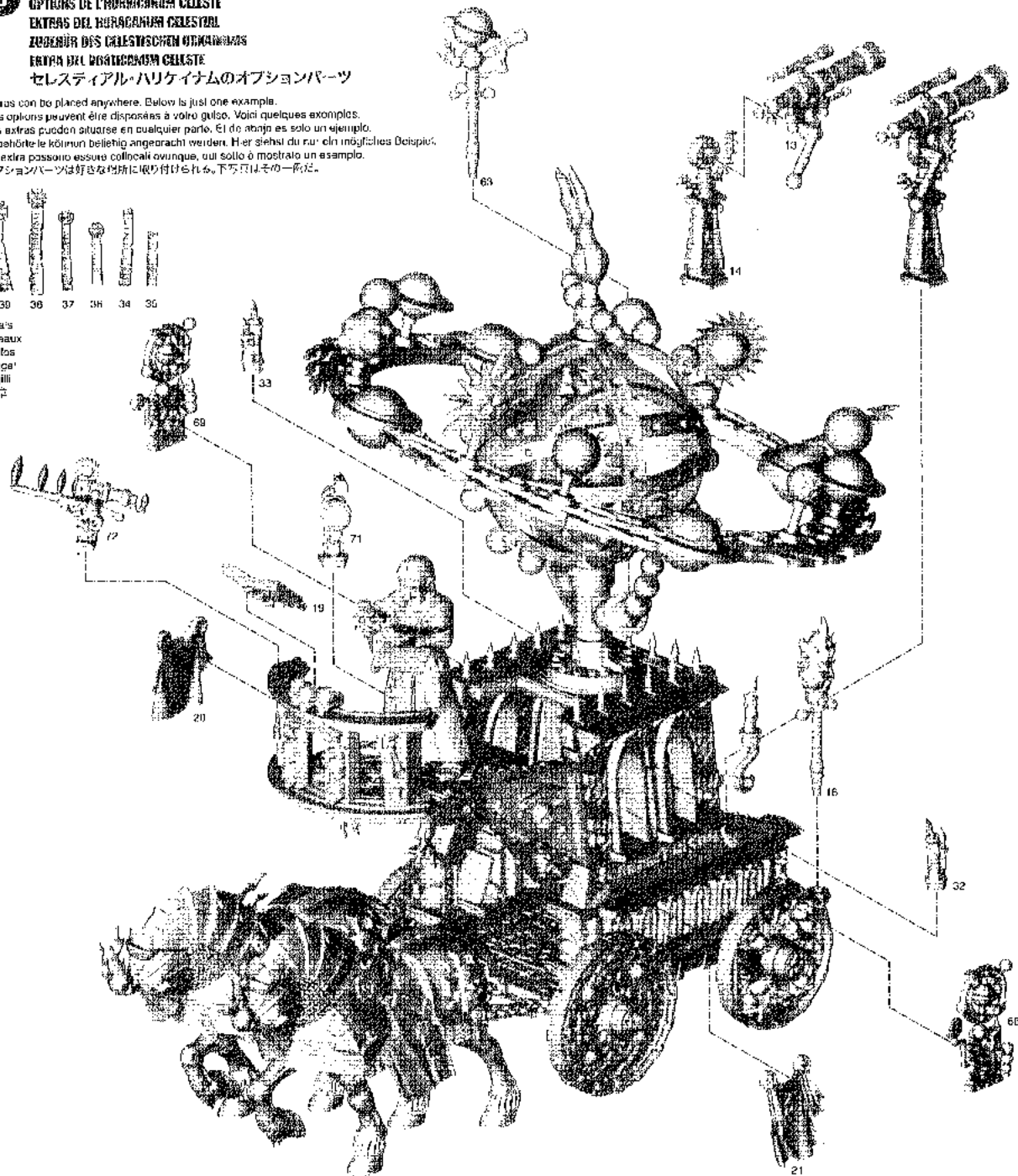

7

WHEEL ASSEMBLY • ASSEMBLAGE DE LA CABINE • PARTITE DEL COSTO
ZUSAMMENBAU DES HUMMERS • ASSEMBLAGGIO DELLA SINTONIA • 車体の組み立て

18 輪組の取り付け • 18 輪組の取り付け • 18 輪組の取り付け
18 輪組の取り付け • 18 輪組の取り付け • 18 輪組の取り付け

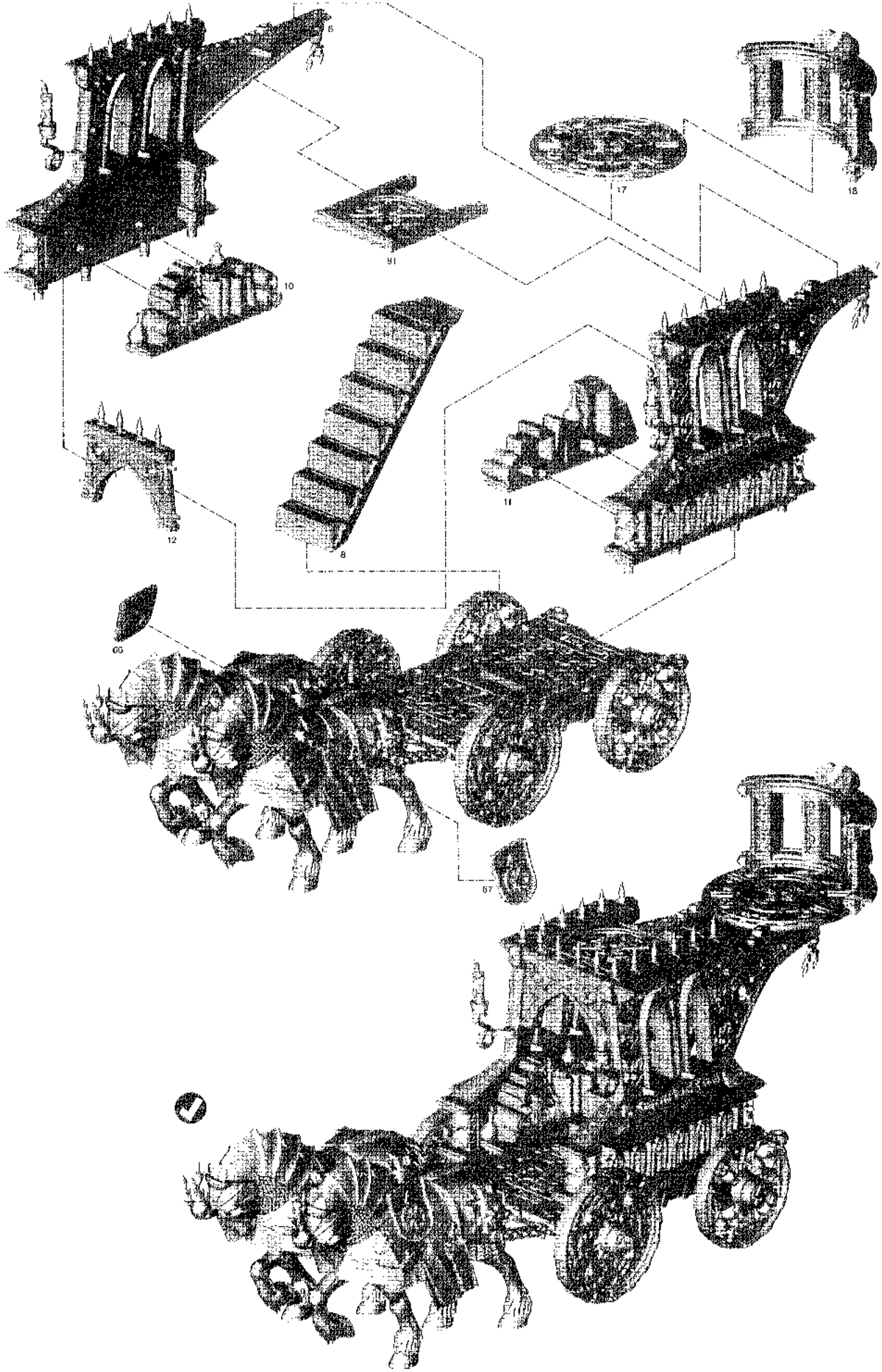

A

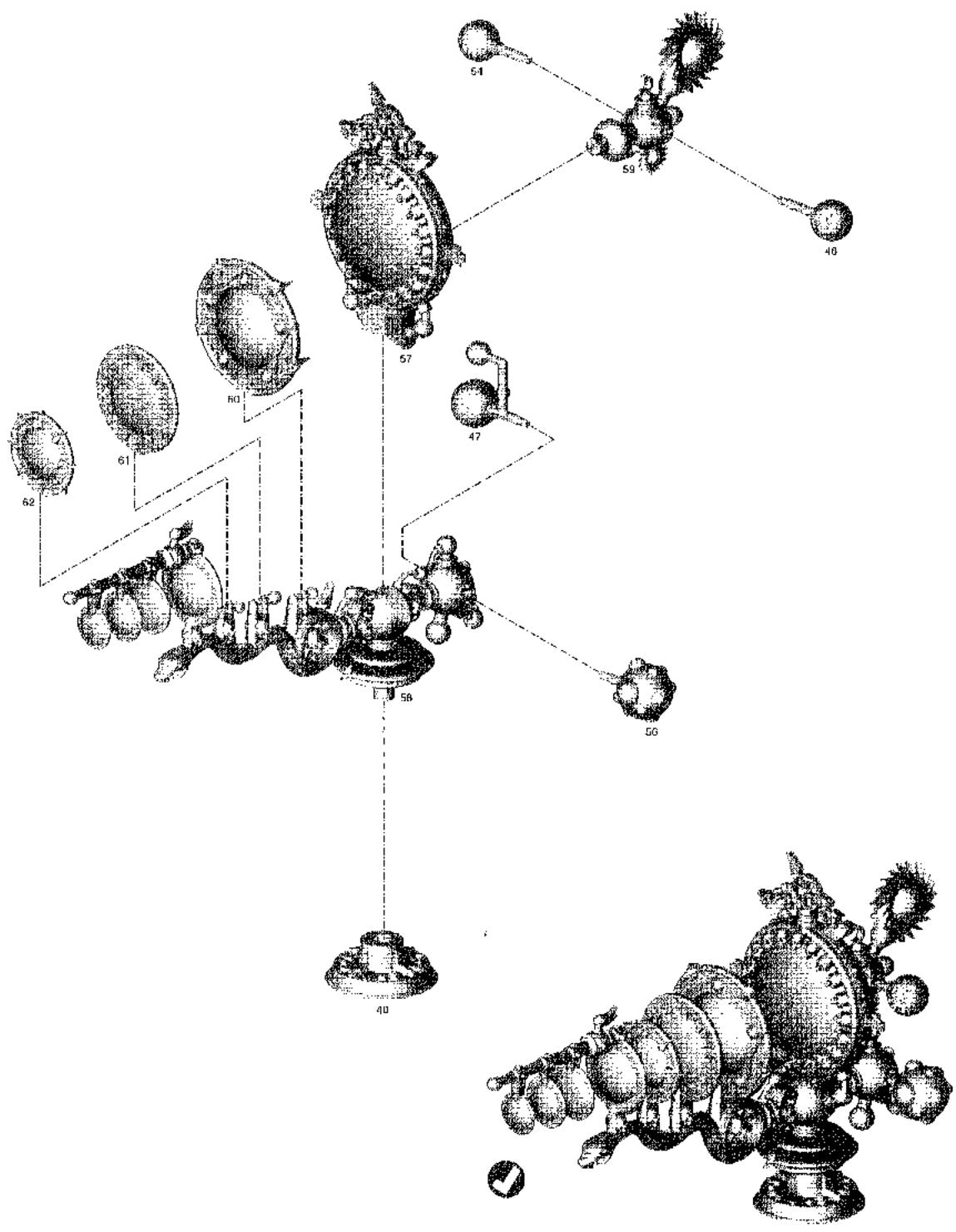

B



LUMINACA TO RUCI ASSIEMBLV - ASSEMBLAGE DE L'ELIENNES A LA CRENE
MONTAGE DEL LUMINACA AL CASCO • ZUSAMMENBAU VON LUMINAKEN MIT HAUBE
ASSEMBLAGGIO DELLA LUMINACAS ALLA STRUTTURA • ルミネークと車体の組み立て

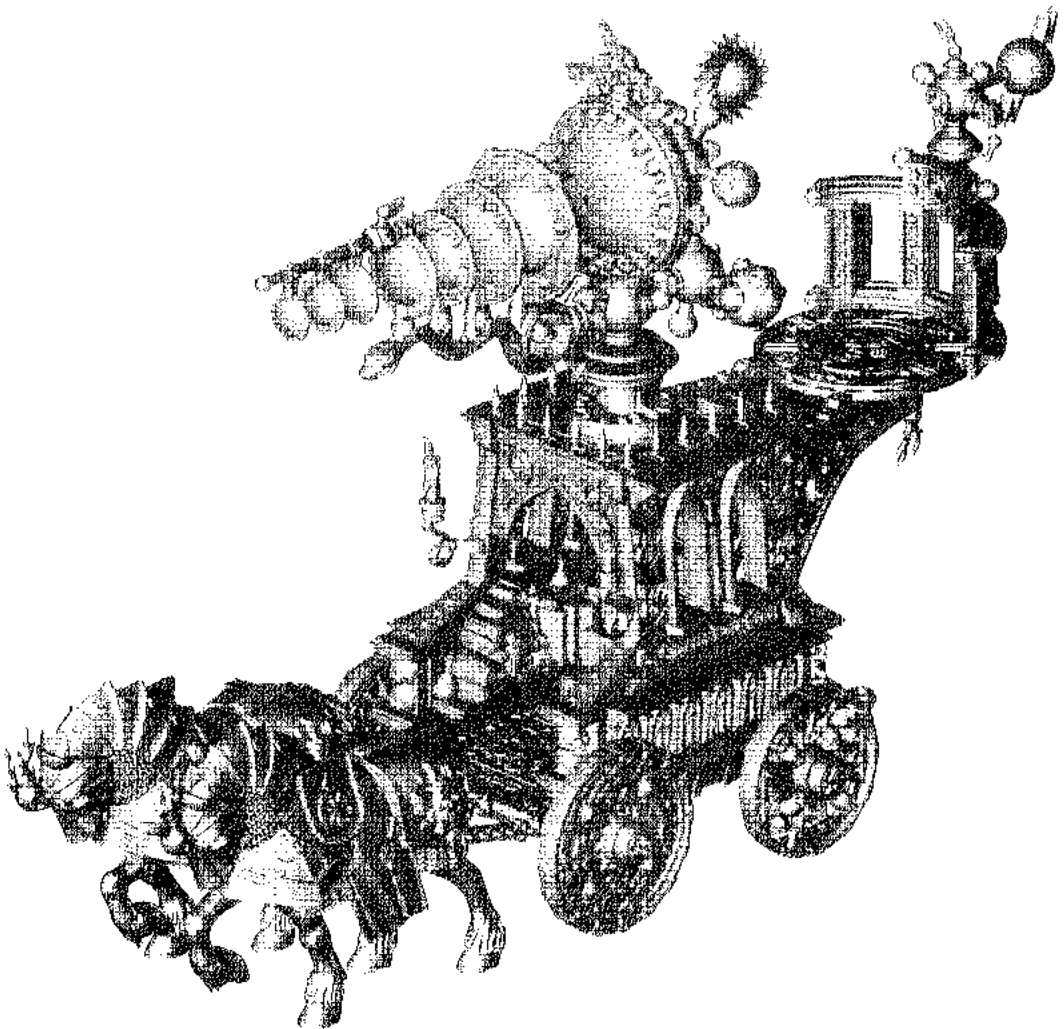
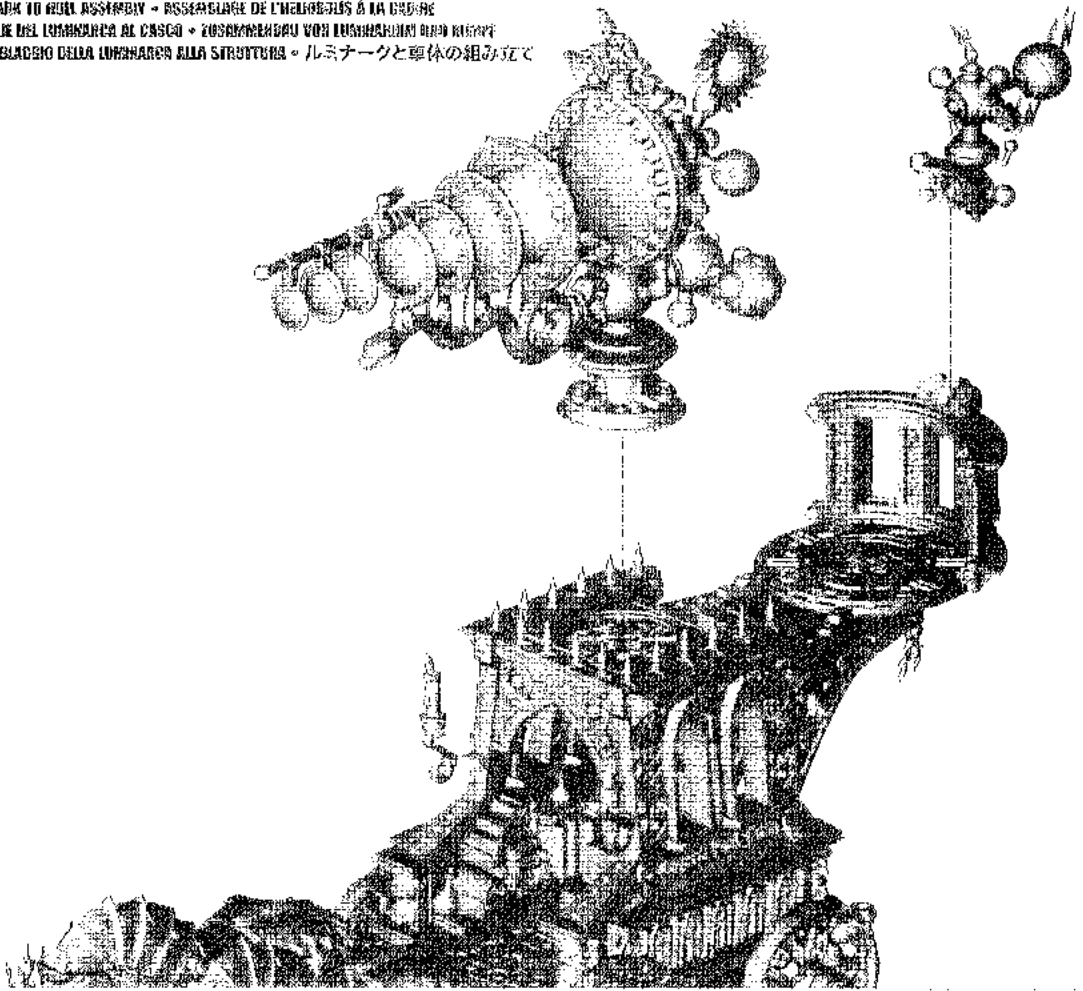

THE LUMBARIA OF NYSH CAN BE ASSEMBLED WITH 2 ACOLITES OR A WIZARD LORD AND 1 ACOLYTE. WIZARD LORD ASSEMBLY IS STAGE 10, ACOLYTE ASSEMBLY IS STAGE 11.

L'EDIFICIO DE NYSH PUEDE MONTARSE CON 2 ACOLITOS O CON UN SEÑOR MAGO Y 1 ACOLITO. PARA L'ASSEMBLAGE DU SEIGNEUR MAGO, VOIR ÉTAPE 10. POUR L'ASSEMBLAGE DE L'ACOLYTE, VOIR ÉTAPE 11.

LA LUMBARIA DE NYSH PUÒDE MONTARSI CON 2 ACOLITI O CON UN PRINCIPALE MAGO E 1 ACOLITO. IL MONTARE DEL PRINCIPALE MAGO È STÀ IN EL PASO 10, E IL DEL ACOLITO IN EL PASO 11.

DAS LUMBARUM DES NYSH KANN MIT 2 ACOLOTEN ODER MIT EINEM HERRSCHER UND 1 ACOLOTEN ERBAUT WERDEN. SCHAU SICH DIE BESCHREIBUNG DER ZUSAMMENBAU DES HERRSCHERS/ACOLITEN, SCHRITT 10 FÜR DEN HERRSCHER, SCHRITT 11 FÜR DEN ACOLOTEN.

LA LUMBARIA DI NYSH PUÒ ESSERE ASSEMBLATA CON 2 ACOLITI O UN SIGNORE E 1 ACOLITO. PER L'ASSEMBLAGGIO DEL PRINCIPALE MAGO VEDI IL PASSO 10, PER QUELLO DELL'ACOLITO VEDI IL PASSO 11.

アコライト2人にするか、ウィザードロード1人とアコライト1人にするかを選択して、ルミナーク・オブ・ハイシュを組み立てる。ウィザードロードの組み立てはステップ10、アコライトの組み立てはステップ11に従うこと。

10

RIGHT WIZARD & NEGATIVE ASSEMBLY - ASSEMBLE DO SEIGNEUR MAGO ET DE SON ACOLYTE
 MONTARE DEL PRINCIPALE Y DEL ACOLITO - ZUSAMMENBAU VON HERRSCHER & ACOLOTEN
 ASSEMBLAGGIO DEL PRINCIPALE MAGO E DELL'ACOLITO - ライトウィザードとアコライトの組み立て

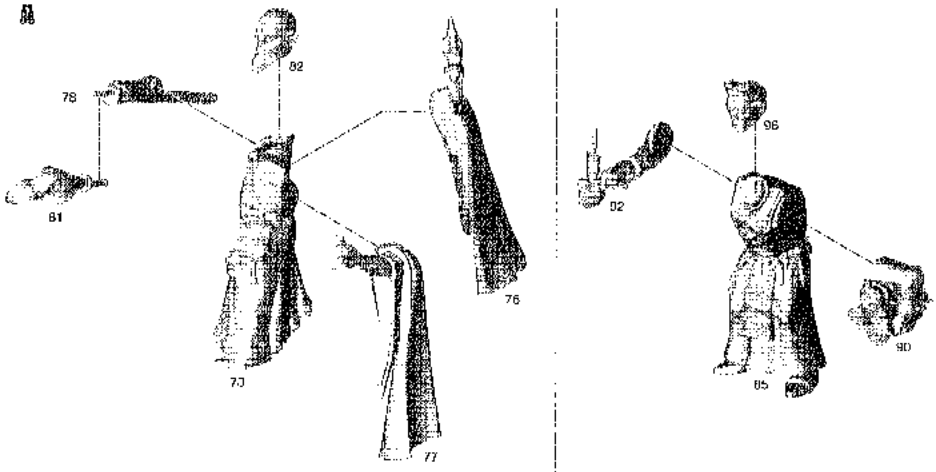

11

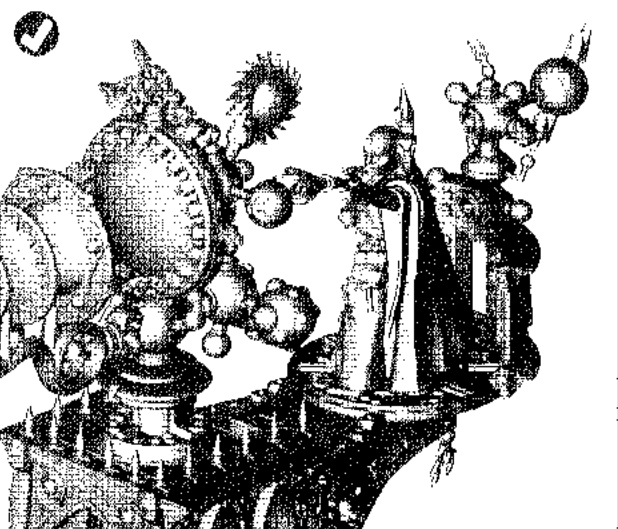
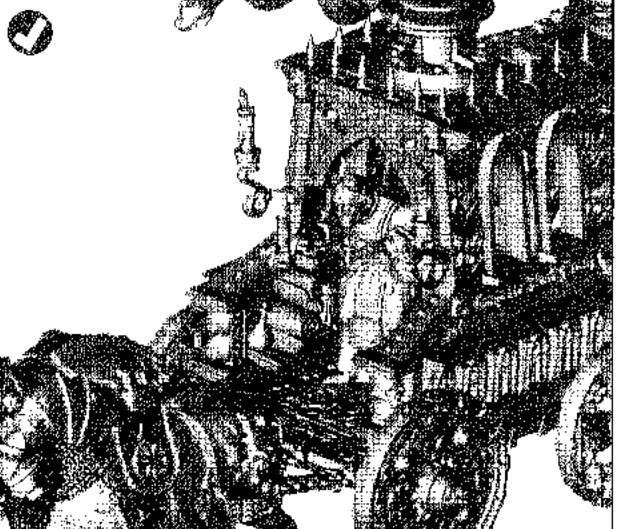
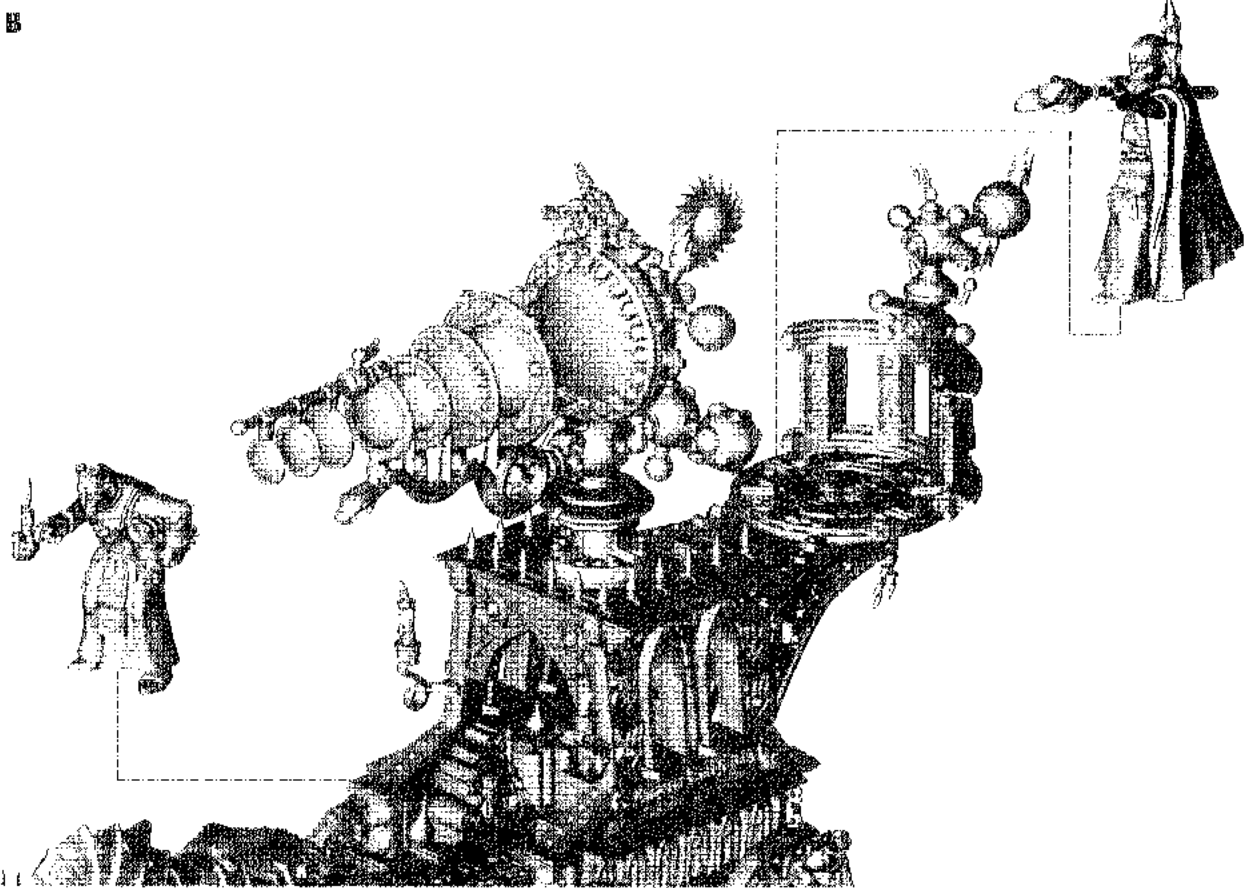

11

ACOLITES ASSEMBLY • ASSEMBLAGE DES ACOÏTES • MONTAJE DE LOS ACOÏTOS
ПОСЛАНИЕ ИЛИ АКОИТОВ • АССАМБЛЕЖ ДРЕВН АКОИТОВ • アコライトの組み立て

A

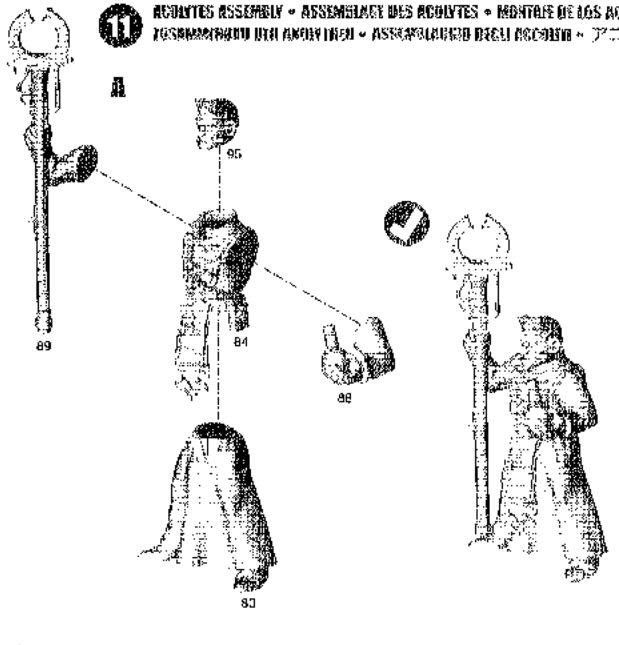

12

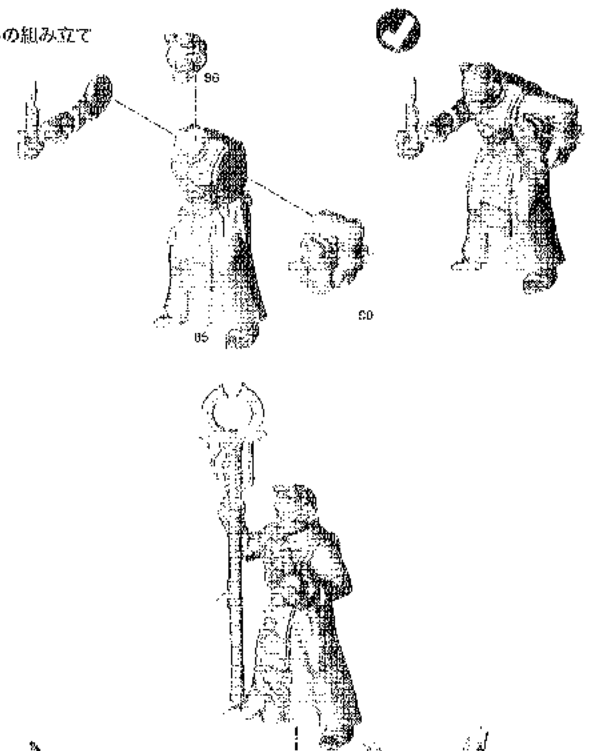

B

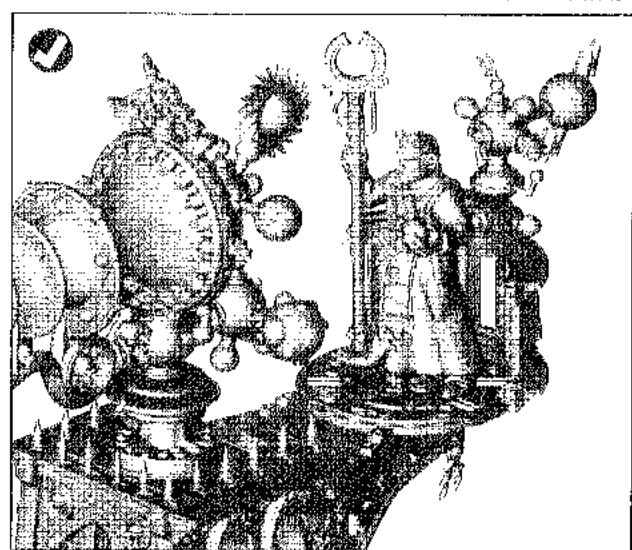
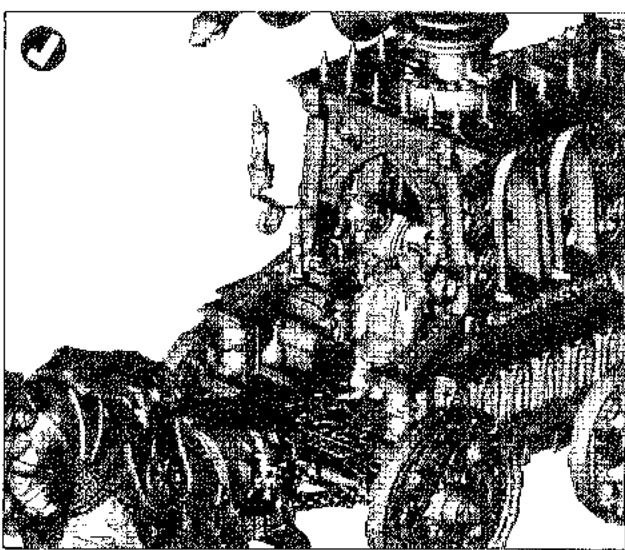
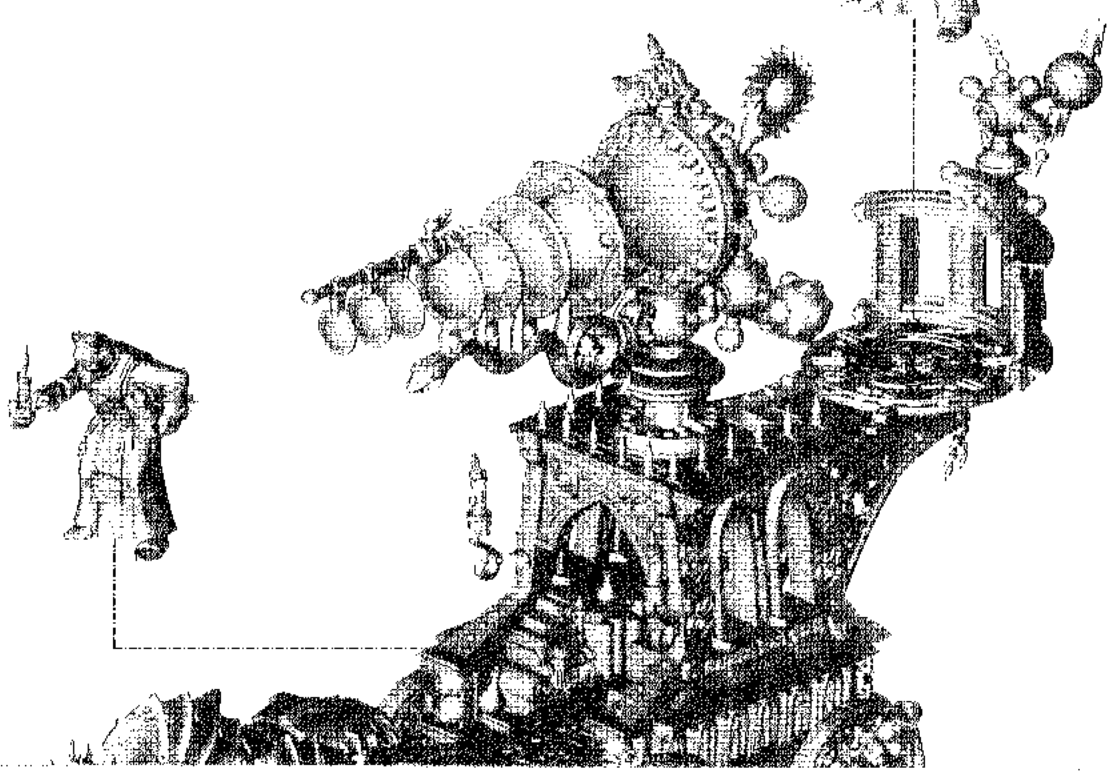

Extras can be placed anywhere. Below is just one example.
 Ces options peuvent être disposées à votre guise. Voici quelques exemples.
 Los extras pueden situarse en cualquier parte. El de abajo es solo un ejemplo.
 Zubehörfelle können beliebig angebracht werden. Hier siehst du nur ein mögliches Beispiel.
 Gli extra possono essere collocati ovunque, qui sotto è mostrato un esempio.
 オプションパーツは好きな場所に取付けられます。トモ角はその一例だ。

- Scale
 - Soucoux
 - Sulfos
 - Siegel
 - Sigilli
 - Etz
- 