



Free Downloads of Build Instructions,
Assembly Booklets & How To Guides

[BuildInstructions.com](https://www.buildinstructions.com)

DWARFS

CITADEL

CHOOSE THE VARIANT YOU WANT TO BUILD • CHOISISSEZ LA VARIANTE À ASSEMBLER • ELIGE EL MODELO QUE VAYAS A MONTAR
WÄHLE DIE VARIANTE, DIE DU BAUEN MÖCHTEST • SCEGLI LA VARIANTE CHE VUOI ASSEMBLARE • 組み立てたい方のミニチュアを選択する

DWARF IRONBREAKERS • BRISE-FER NAINS • ROMPEHIERROS ENANOS
EISENBRECHER DER ZWERGE • NANI SPACCAFERRO • ドワーフ アイアンブレイカー

STEPS
ÉTAPES
PASOS
SCHRITTE
FASI
ステップ

1 - 6



DWARF IRONDRAKES • DRACS DE FER NAINS • DRAGONHIERROS ENANOS
EISENDRACHEN DER ZWERGE • NANI DRAGHI DI FERRO • ドワーフ アイアンドレイク

STEPS
ÉTAPES
PASOS
SCHRITTE
FASI
ステップ

1 &
7 - 11



WARHAMMER

© Copyright 2013, Games Workshop Ltd. All rights reserved.



993102050120



Follow step 1 for all variants • Suivre l'étape 1 pour toutes les variantes
Sigue el paso 1 para todas las variantes • Folge Schritt 1 für alle Varianten
Segui la fase 1 per tutte le varianti • どのバリエーションもステップ1に従う

1

BODY ASSEMBLY • ASSEMBLAGE DES DIVERS CORPS • MONTAJE DEL CUERPO
ZUSAMMENBAU DER KÖRPER • ASSEMBLAGGIO DEL CORPO • 体の組み立て

A

x2

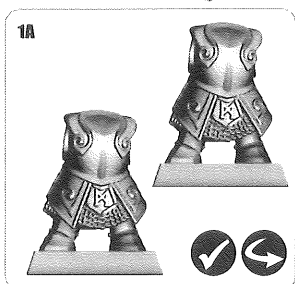
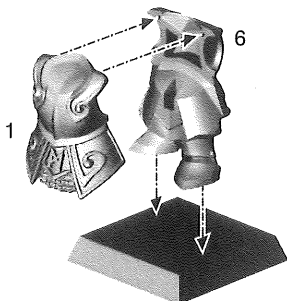

B

x2

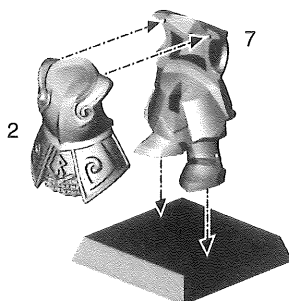

C

x2

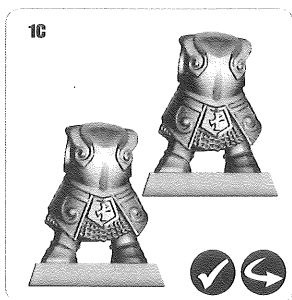
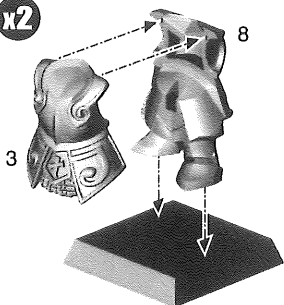

D

x2

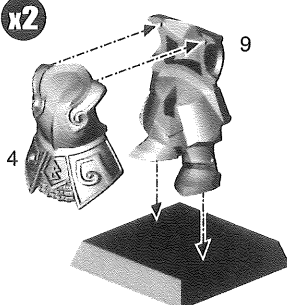

E

x2

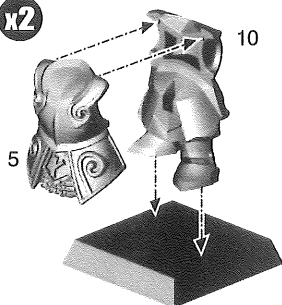

2 - 6

DWARF IRONBREAKERS • BRISE-FER NAINS • ROMPEHIERROS ENANOS

EISENBRECHER DER ZWERGE • NANI SPACCAFERRO • ドワーフ アイアンブレイカー

2 IRONBREAKER OPTIONS • OPTIONS DES BRISE-FER • OPCIONES DE ROMPEHIERROS

OPTIONEN FÜR DIE EISENBRECHER • OPZIONI PER GLI SPACCAFERRO • アイアンブレイカーのオプション

A

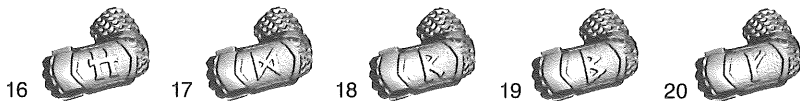

Shield arms (Left) • Bras avec bouclier (Gauches) • Brazos del escudo (Izquierdo)
Schildarme (Links) • Braccia con scudo (Sinistre) • シールド用の腕(左)

B



Ironbreaker Shoulder Pads (Left) • Épaulettes des Brise-fer (Gauches) • Hombreras de Rompehierros (Izquierda)
Schulterpanzer der Eisenbrecher (Links) • Spallacci degli Spaccaferro (Sinistri) • アイアンブレイカーの肩当て(左)

C



Dwarf Shoulder Pads (Right) • Épaulettes de Martelier (Droite) • Hombreras de Martilladores (Derecha)
Schulterpanzer der Zwerge (Rechts) • Spallacci dei Nani (Destri) • ドワーフの肩当て(右)

3 IRONBEARD ASSEMBLY • ASSEMBLAGE DU BARBE DE FER • MONTAJE DE BARBAHIERRO

ZUSAMMENBAU DES EISENBARTES • ASSEMBLAGGIO DEL BARBADIFERRO • アイアンベアードの組み立て

A

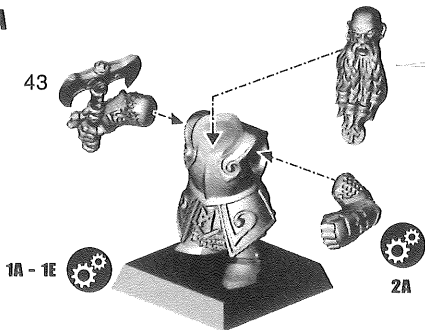

Ironbeard heads • Têtes du Barbe de Fer
Cabezas de Barbahierro
Kopfvarianten für den Eisenbart
Teste del Barbadiferro • アイアンベアードの頭

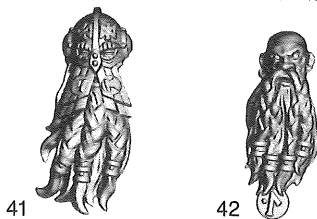

B

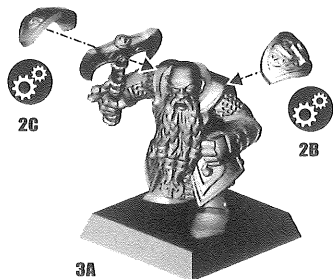

C

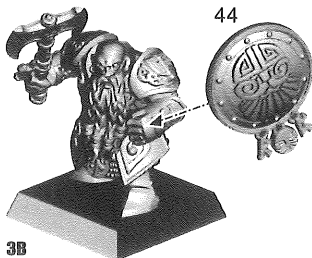

D



4

MUSICIAN ASSEMBLY • ASSEMBLAGE DU MUSICIEN • MONTAJE DEL MÚSICO

ZUSAMMENBAU DES MUSIKERS • ASSEMBLAGGIO DEL MUSICO • ミュージシャンの組み立て

A

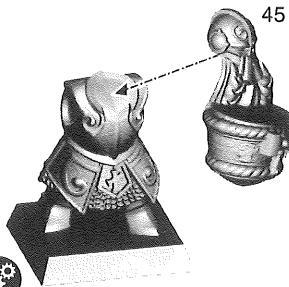

1A - 1E



B

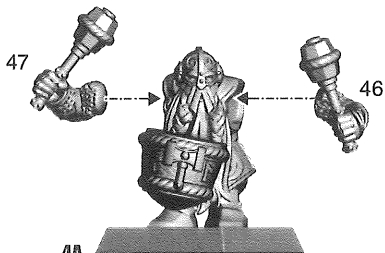

4A

C

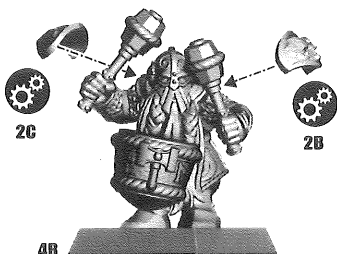

2C

2B

4B

D



5

STANDARD BEARER ASSEMBLY • ASSEMBLAGE DU PORTE-ÉTENDARD • MONTAJE DEL PORTAESTANDARTE

ZUSAMMENBAU DES STANDARTENTRÄGERS • ASSEMBLAGGIO DELL'ALFIERE • スタンダードベアラーの組み立て

A

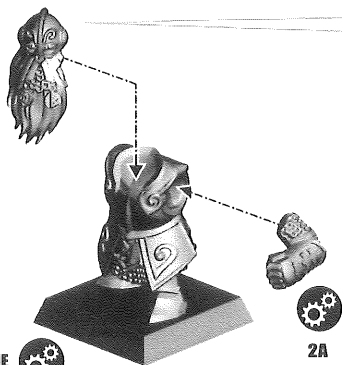

1A - 1E



2A



Ironbreaker heads • Têtes de brise-fer
Cabezas de Rompehierros • Köpfe der Eisenbrecher
Teste degli Spaccalferro • アイアンブレイカーの頭



11



12



13





14



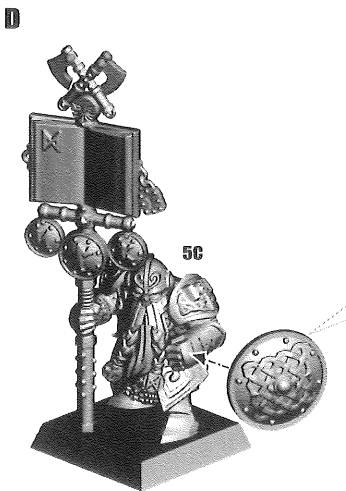
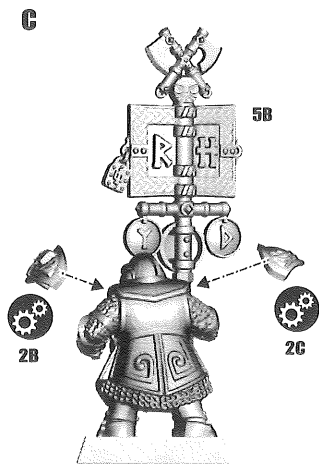
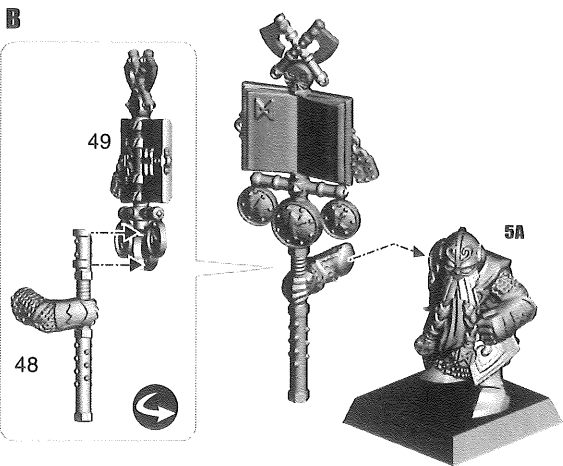

15

5 STANDARD BEARER ASSEMBLY • ASSEMBLAGE DU PORTE-ÉTENDARD • MONTAJE DEL PORTAESTANDARTE
 ZUSAMMENBAU DES STANDARTENTRÄGERS • ASSEMBLAGGIO DELL'ALFIERE • スタンダードベアラーの組み立て

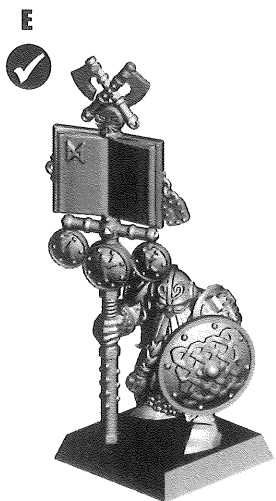
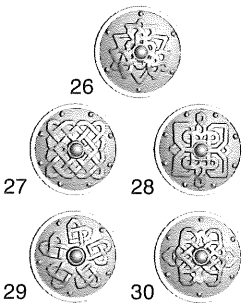

 Choice of Shields
 Choix de boucliers
 Modelos de escudo
 Auswahl an Schilden
 Scelta di scudi
 好きなシールドを選択



 Optional Axe (50) can be added to the Musician's back or the Standard Bearer's back.

La hache optionnelle (50) peut être ajoutée dans le dos du musicien ou du porte-étendard.

Este hacha opcional (50) se puede montar en la espalda del Músico o del Portaestandarte.

Diese Axt (50) kann optional am Rücken des Musikers oder des Standartenträgers befestigt werden.

L'ascia opzionale (50) può essere aggiunta sulla schiena del musicista o dell'alfiere.

オプションのアクス(50)はミュージシャンの背中、またはスタンダードベアラーの背中に追加できる。

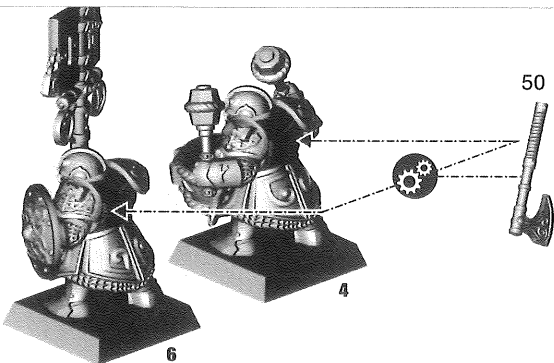

6

**IRONBREAKER ASSEMBLY • ASSEMBLAGE DES BRISE-FER • MONTAJE DE ROMPEPIERROS
ZUSAMMENBAU DER EISENBRECHER • ASSEMBLAGGIO DEGLI SPACCAFERRO • アイアンブレイカーの組み立て**

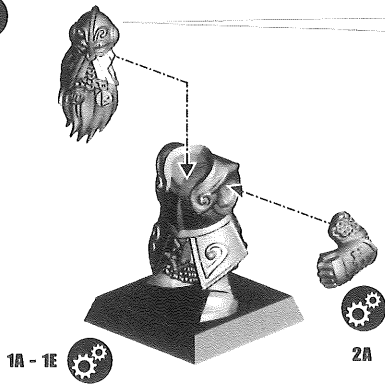
A**x7**

**Ironbreaker heads • Têtes de brise-fer
Cabezas de Rompehierros • Köpfe der Eisenbrecher
Teste degli Spaccaferro • アイアンブレイカーの頭**

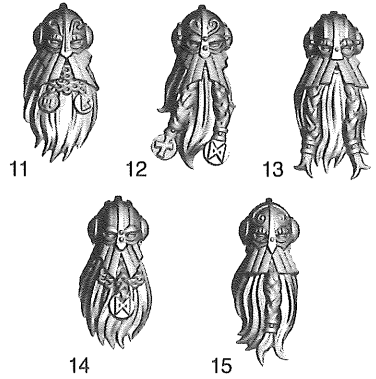
**B****x7**

**Hand weapons • Armes de base
Armas de mano • Handwaffen
Armi a una mano • ハンドウェポン**

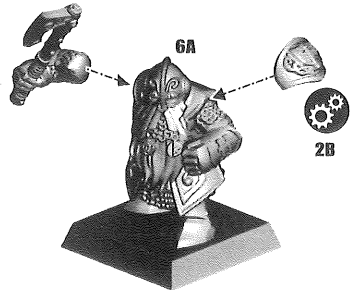
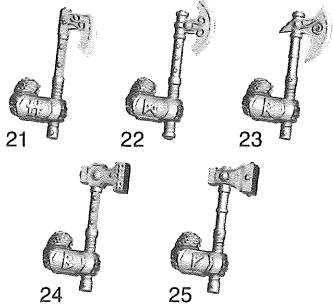
**C****x7**

**Choice of Shields
Choix de boucliers
Modelos de escudo
Auswahl an Schilden
Scelta di scudi
好きなシールドを選択**

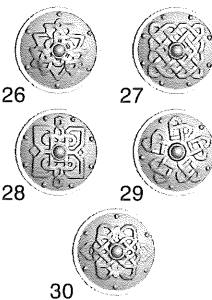
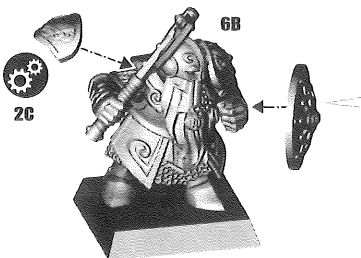
**D**

7 IRONDRAKE OPTIONS • OPTIONS DES DRACS DE FER • OPCIONES DE DRACOHIERRO
OPTIONEN FÜR DIE EISENDRACHEN • OPZIONI PER I DRAGHI DI FERRO • アイアンドレイクのオプション

A

 Iron Drake Shoulder Pads (Left) • Épaulières des Dracs de Fer (Gauches) • Hombrosas de Dracohierro (Izquierda)
 Schulterpanzer der Eisendrachen (Links) • Spallacci dei Draghi di Ferro (Sinistri) • アイアンドレイクの肩当て (左)

B

 Dwarf Shoulder Pads (Right) • Épaulières de Martelier (Droite) • Hombrosas de Martilladores (Derecha)
 Schulterpanzer der Zwerge (Rechts) • Spallacci dei Nani (Destri) • ドワーフの肩当て (右)

8 IRONWARDEN ASSEMBLY • ASSEMBLAGE DU GARDIEN DE FER • MONTAJE DE GUARDIÁN DE HIERRO
ZUSAMMENBAU DES EISENWÄCHTERS • ASSEMBLAGGIO DELLA GUARDIA DI FERRO • アイアンワーデンの組み立て

A

1A - 1E

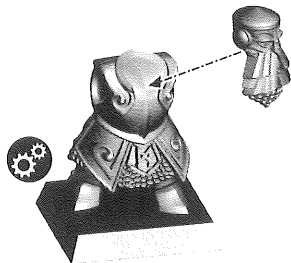

 Ironwarden heads • Têtes du Gardien de Fer
 Cabezas de Guardián de Hierro
 Kopfvarianten für den Eisenwächter
 Teste della Guardia di Ferro • アイアンワーデンの頭

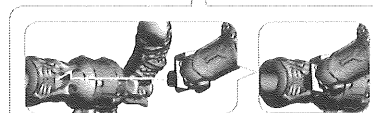
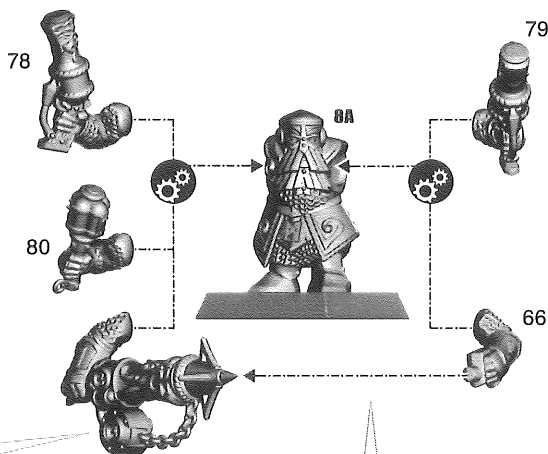
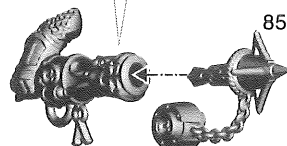
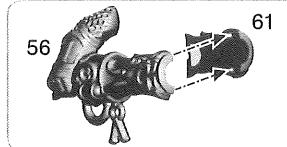
B

TROLLHAMMER TORPEDO
TORPILLE À TROLL
TORPEDO MARTILLO DE TROLL
TROLLHAMMER-HARPUNE
SILURO ANTTITROLL
トロールハンマー・トルビード

8 IRONWARDEN ASSEMBLY • ASSEMBLAGE DU GARDIEN DE FER • MONTAJE DE GUARDIÁN DE HIERRO
 ZUSAMMENBAU DES EISENWÄCHTERS • ASSEMBLAGGIO DELLA GUARDIA DI FERRO • アイアンワーデンの組み立て

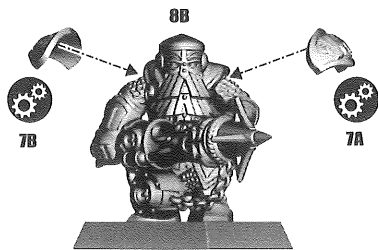
C



D



WITH TROLLHAMMER TORPEDO • AVEC TORPILLE À TROLL
 CON TORPEDO MARTELLO DE TROLL • MIT TROLLHAMMER-HARPUNE
 CON SILURO ANTITROLL • トロールハンマー・トルビード装備

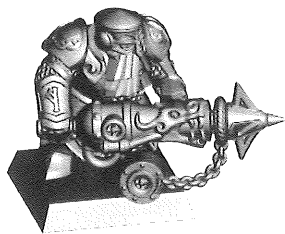

WITH CINDERBLAST BOMB & DRAKEFIRE PISTOL
 AVEC BOMBE À CENDRÉE & PISTOLET DRAC DE FEU
 CON BOMBA DE BRASAS Y PISTOLA DRAGO
 MIT ZWERGGRANATE & DRACHENPISTOLE
 CON BOMBA DI BRACE E PISTOLA FUOCO DEL DRAGO
 シンダーブラスト・ボム&ドレイクファイア・ピストル装備

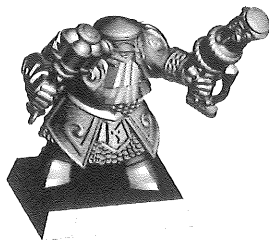

WITH DRAKEFIRE PISTOLS
 AVEC PISTOLETS DRAC DE FEU
 CON RISTRA DI PISTOLE DRAGO
 MIT DRACHENPISTOLENPAAR
 CON PISTOLE FUOCO DEL DRAGO
 ドレイクファイア・ピストル装備

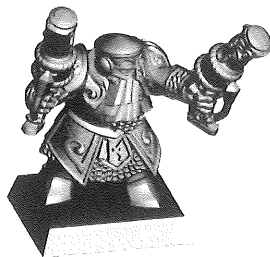

9 MUSICIAN ASSEMBLY • ASSEMBLAGE DU MUSICIEN • MONTAJE DEL MÚSICO
 ZUSAMMENBAU DES MUSIKERS • ASSEMBLAGGIO DEL MUSICO • ミュージシャンの組み立て

A

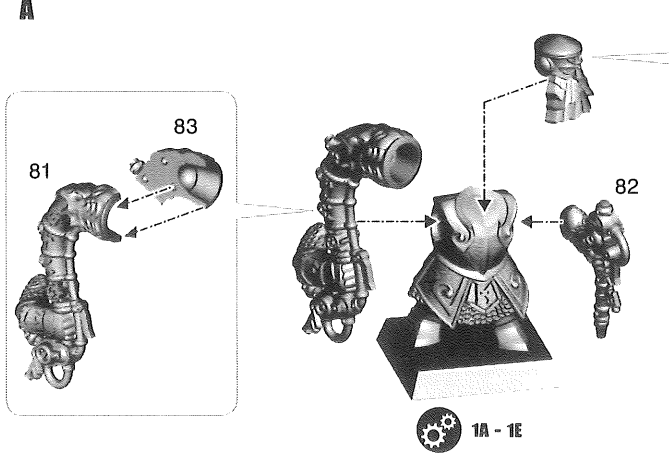

Irondrake heads
 Têtes des Dracs de Fer
 Cabezas de Dracohierro
 Köpfe der Eisendrachen
 Teste dei Draghi di Ferro
 アイアンドレイクの頭

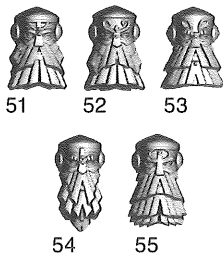

9 MUSICIAN ASSEMBLY • ASSEMBLAGE DU MUSICIEN • MONTAJE DEL MÚSICO
 ZUSAMMENBAU DES MUSIKERS • ASSEMBLAGGIO DEL MUSICO • ミュージシャンの組み立て

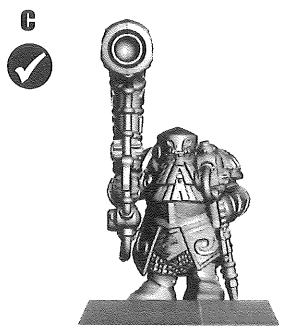
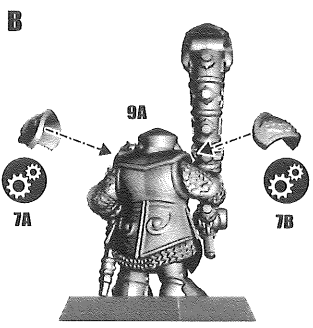

10 STANDARD BEARER ASSEMBLY • ASSEMBLAGE DU PORTE-ÉTENDARD • MONTAJE DEL PORTAESTANDARTE
 ZUSAMMENBAU DES STANDARTENTRÄGERS • ASSEMBLAGGIO DELL'ALFIERE • スタンダードベアラーの組み立て

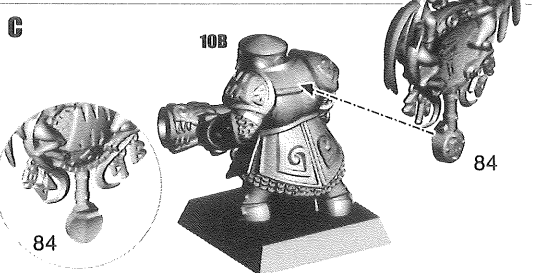
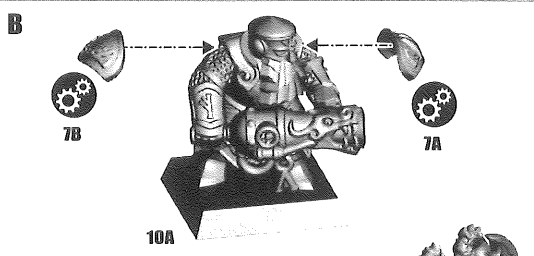
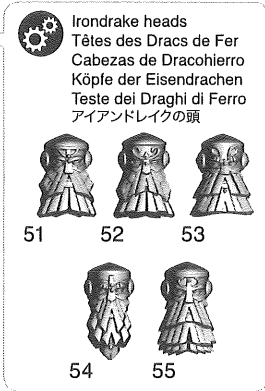
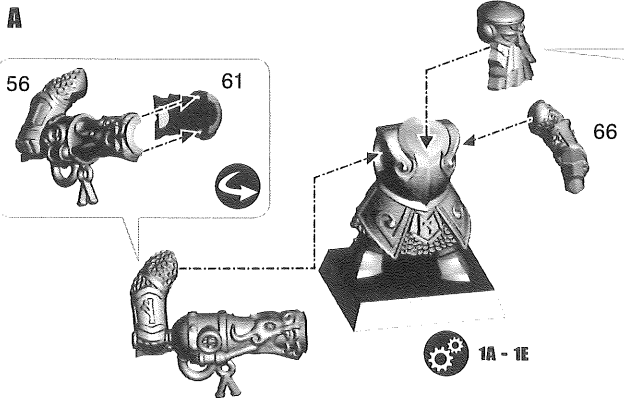

11**IRONDRAKES • DRACS DE FER • DRACOHIERROS
EISENDRACHEN • DRAGHI DI FERRO • アイアンドレイク****A****x7****Irondrake heads • Têtes des Dracs de Fer
Cabezas de Dracohierro • Köpfe der Eisendrachen
Teste dei Draghi di Ferro • アイアンドレイクの頭**

51



52



53



54



55



57

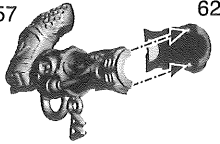

62



58

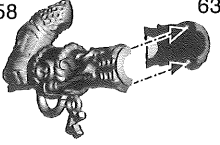

63

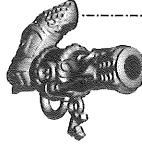

59

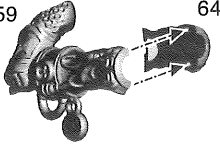

64

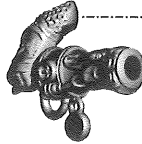

60

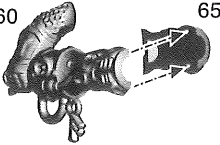

65

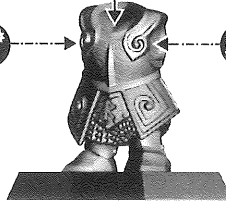
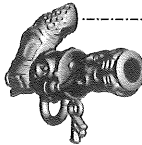
**1A - 1E**

67



68



69

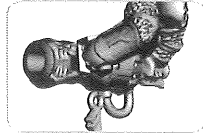
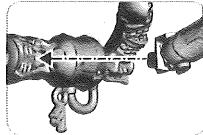
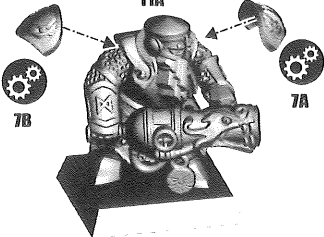

70

**B****x7****11A****C****Ensure arms with matching armour**

Vérifiez le positionnement des bras

Encaja los brazos con la armadura

correcta

Die Rüstungselemente zeigen,

welche Arme zusammengehören

Accertati che le braccia abbiano la

stessa armatura

左右の腕の鎧が一致しているか確認



60



70



DWARFS

	M	WS	BS	S	T	W	I	A	Ld	Troop Type
Ironbreaker	3	5	3	4	4	1	2	1	10	Infantry
Ironbeard	3	5	3	4	4	1	2	2	10	Infantry



	M	WS	BS	S	T	W	I	A	Ld	Troop Type
Ironrake	3	5	3	4	4	1	2	1	10	Infantry
Ironwarden	3	5	4	4	4	1	2	1	10	Infantry

