



Free Downloads of Build Instructions,  
Assembly Booklets & How To Guides

**BuildInstructions.com**

# WARHAMMER 40,000

## DESOLATION SQUAD

ESCOUADRE DESOLATOR | ESCUADRA DE DESOLADORES | DESOLATORTRUPP

SQUADRA DESOLATORI | デソレイション・スカッド | 寂滅小队



**!** READ THIS FIRST | À LIRE EN PRIORITÉ | BITTE BEACHTEN | LEE ESTO PRIMERO | LEGGI PRIMA QUESTO  
最初にお読みください。 | 请优先阅读

**ENG** BEFORE ASSEMBLING YOUR MINIATURES, PLEASE READ THROUGH THE INSTRUCTIONS IN THIS BOOKLET CAREFULLY. A pair of plastic cutters is required to remove the plastic components in this kit from their frame. We advise using a mouldline scraping tool to clean up the parts. To assemble your model you will need plastic glue. Games Workshop sells Citadel Fine Detail Cutters, Citadel Mouldline Remover and Citadel Plastic Glue, but does not recommend these products for use by children under the age of 16 without adult supervision.

**FRE** AVANT D'ASSEMBLER VOS FIGURINES, VEUILLEZ LIRE ATTENTIVEMENT LES INSTRUCTIONS DE CE LIVRET. Une pince coupante est requise pour détacher chaque élément de sa grappe. Nous vous recommandons l'utilisation d'un grattoir pour ébarber les éléments. Pour l'assemblage, vous aurez également besoin de colle plastique. Games Workshop commercialise les Pinces de Précision Citadel, l'Ébarboir Citadel et la Colle Plastique Citadel, mais n'en recommande pas l'utilisation pour des enfants de moins de 16 ans sans la supervision d'un adulte.





**SPA** POR FAVOR, LEE CUIDADOSAMENTE ESTE LIBRETO DE INSTRUCCIONES ANTES DE EMPEZAR A MONTAR LAS MINIATURAS. Te harán falta unas tenazas para plástico a fin de separar las piezas de la matriz. También aconsejamos una herramienta para rebabas a fin de limpiar cada pieza. Para montar la miniatura necesitarás pegamento para plástico. Games Workshop vende Tenazas Citadel, Herramientas para rebabas Citadel y Pegamento para plástico Citadel, pero no recomienda estos productos a menores de 16 años sin la supervisión de un adulto.

**GER** VOR DEM ZUSAMMENBAU DER MINIATUREN BITTE DIE ANWEISUNGEN IN DIESER ANLEITUNG AUFMERKSAM DURCHLESEN. Du benötigst einen Kunststoffseitenschneider, um die Kunststoffbauteile aus dem Gussrahmen herauszutrennen, und Kunststoffkleber, um die Miniatur zusammenzubauen. Außerdem empfehlen wir, die Bauteile vorher mit einem Gussgratentferner zu säubern. Games Workshop bietet Präzisions-Kunststoffseitenschneider von Citadel sowie Citadel-Kunststoffkleber an, empfiehlt aber, dass Kinder unter 16 Jahren diese nur unter Aufsicht eines Erwachsenen benutzen.

**ITA** PRIMA DI ASSEMBLARE LE TUE MINIATURE LEGGI ATTENTAMENTE TUTTE LE ISTRUZIONI DI QUESTO LIBRETTO. Sono necessarie un paio di tronchesine per plastica per staccare i componenti dai loro sprue. Consigliamo di usare un attrezzo apposito per pulire i componenti. Per assemblare il modello avrai bisogno di colla per plastica. Games Workshop vende Tronchesine di precisione Citadel, Attrezzo per ripulire Citadel e Colla per plastica Citadel, ma non consiglia questi prodotti ad un pubblico minore di 16 anni senza la supervisione di un adulto.

**日本語** 本キット内のフレームからプラスチックパーツを切り離すためには、ニッパーが必要です。パーツのモールドを平らにするには、専用ツールの使用をお勧めいたします。本キットの組み立てには、プラ用接着剤が必要です。ゲームズワークショップはシタデル・ニッパー



-  Special instruction - take care
- Instruction spéciale - faites attention
- Instrucciones especiales - presta atención
- Besondere Anweisung - bitte beachten
- Istruzioni speciali: prestare attenzione
- 特記事項 - 要注意
- 特别说明 - 小心
-  Dry fit stage before gluing
- Tester avant de coller
- Comprobar el encaje antes de pegar
- Positionierung erst ohne Klebstoff ausprobieren
- Prova a secco prima di incollare
- 接着前にぴったり合わせること
- 粘着前の假組阶段
-  Use matching parts
- Utiliser les éléments correspondants
- Usa las piezas que correspondan
- Verwende die passenden Teile
- Usa le parti corrispondenti
- 適合するパーツを使用
- 使用匹配部件
-  Choice of parts
- Choix d'éléments
- Modelos de componentes
- Auswahl an Teilen
- Scelta di componenti
- パーツの選択
- 选择部件
-  Variant assembly
- Variante d'assemblage
- Variante de montaje
- Bauvariante
- Assemblaggio alternativo
- 組み立てバリエーション
- 多种组装方式
-  Stage complete
- Étape terminée
- Paso completado
- Schritt abgeschlossen
- Fase completa
- このステージの完成
- 完成



BUILD VARIANTS | VARIANTES D'ASSEMBLAGE | VARIANTES DE MONTAJE | BAUVARIANTEN  
VARIANTI D'ASSEMBLAGGIO | バリエーション | 变体版

-  Assemblies for build variants are colour coded.
- Les assemblages de variantes ont un code couleur.
- Las instrucciones para montajes alternativos se indican con un color diferente.
- Optionen für Bauvarianten sind farblich markiert.
- Le diverse varianti d'assemblaggio sono divise per colore.
- バリエーション違いの組み立ては色分けされている。
- 变体版拼装部件有颜色区分。

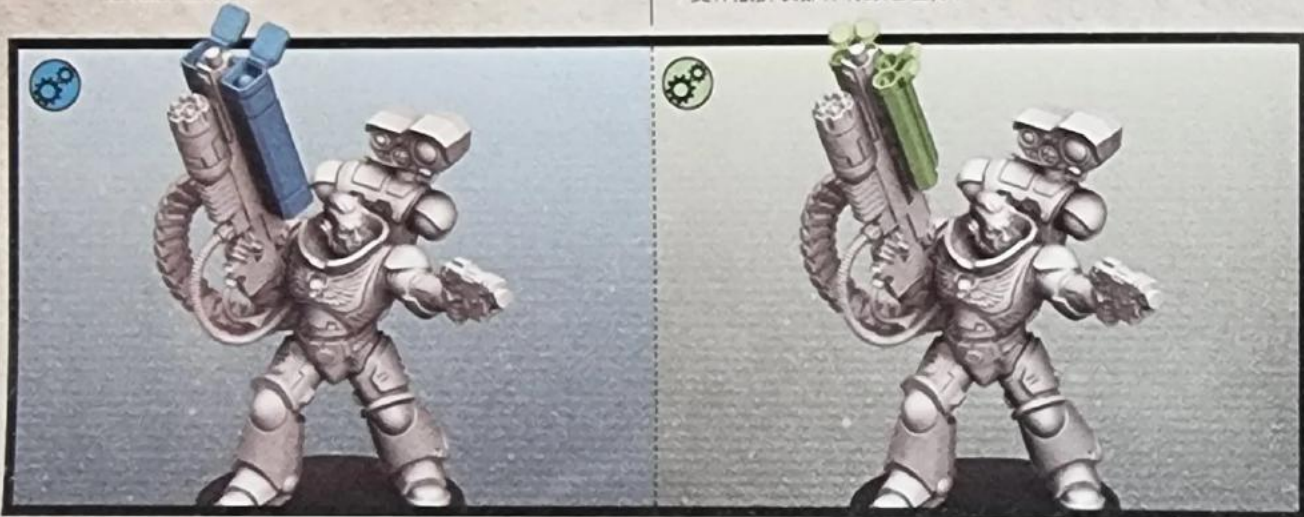

CONTENTS | CONTENU | CONTENIDO | INHALT | CONTENUTO | コンテンツ | 内含板件



Ø 32mm x5

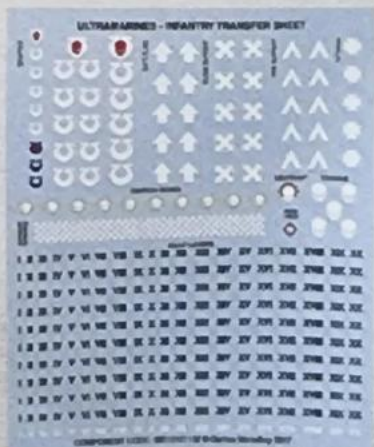



CHOOSE THE VARIANT YOU WANT TO BUILD | CHOISISSEZ LA VARIANTE À ASSEMBLER  
ELIGE QUÉ VERSIÓN QUIERES MONTAR | WÄHLE DIE VARIANTE, DIE DU BAUEN MÖCHTEST  
SCEGLI LA VARIANTE CHE VUOI ASSEMBLARE | 組み立てバリエーションの選択 | 选择你喜欢的拼装方式

 **DESOLATION SQUAD WITH  
SUPERKRACK ROCKET LAUNCHERS**

ESCOUADE DESOLATOR AVEC LANCE-ROQUETTES SUPERKRACK  
ESCUADRA DE DESOLADORES CON LANZACOHETES SUPERPERFORANTES  
DESOLATORTRUPP MIT HYPERSPRENGRAKETENWERFERN  
SQUADRA DESOLATORI CON LANCIARAZZI SUPERPERFORANTE  
デソレイション・スカッド(スーパークラック・ロケットランチャー装備)  
装备超穿甲火箭发射器的寂灭小队



 **DESOLATION SQUAD WITH  
SUPERFRAG ROCKET LAUNCHERS**

ESCOUADE DESOLATOR AVEC LANCE-ROQUETTES SUPERFRAG  
ESCUADRA DE DESOLADORES CON LANZACOHETES DE SUPERFRAGMENTACIÓN  
DESOLATORTRUPP MIT HYPERFRAGMENTRAKETENWERFERN  
SQUADRA DESOLATORI CON LANCIARAZZI A SUPERFRAMMENTAZIONE  
デソレイション・スカッド(スーパーフラグ・ロケットランチャー装備)  
装备超破片火箭发射器的寂灭小队







- Choose the variant you want to build
- Choisissez la variante à assembler
- Elige qué versión quieres montar
- Wähle die Variante, die du bauen möchtest
- Scegli la variante che vuoi assemblare
- 組み立てバリエーションの選択
- 选择你喜欢的拼装方式

1



• Desolation Sergeant • Sergent Desolator  
• Sargento Desolador • Desolator-Sergeant  
• Desolatore Sergente  
• デソレイション・サージェント  
• 寂滅軍士

2



1 a

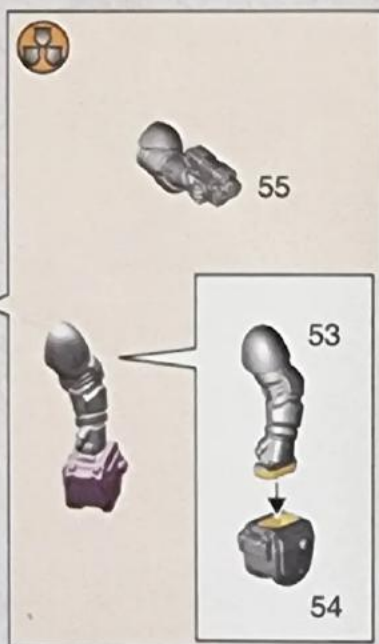

1 b

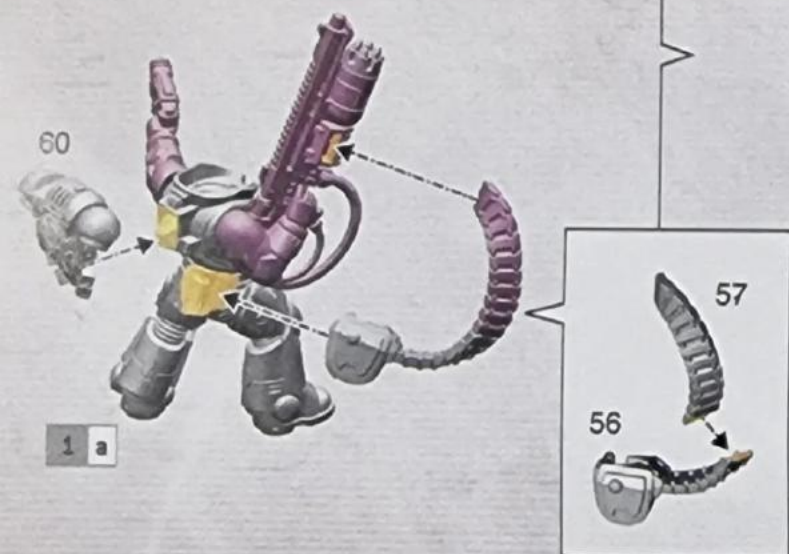
Ø  
32mm

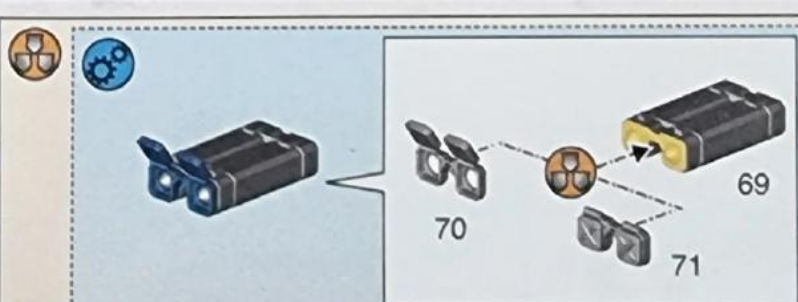
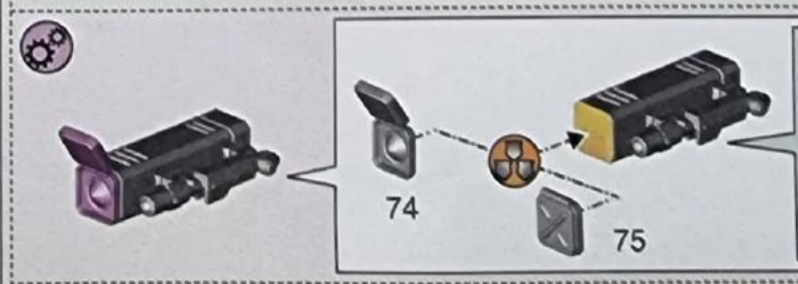
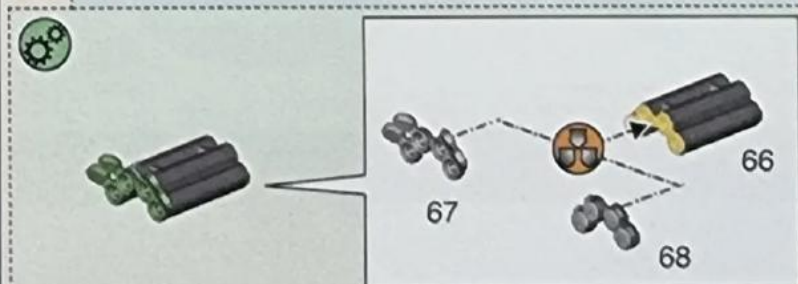

**1 c****1 b****! 1 d****1 d****1 c**



2 a

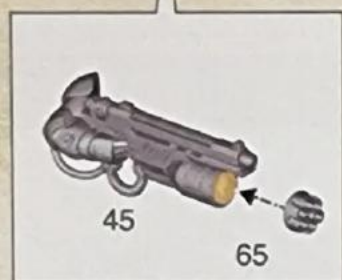

2 b

2 a



Ø 32mm

2 c

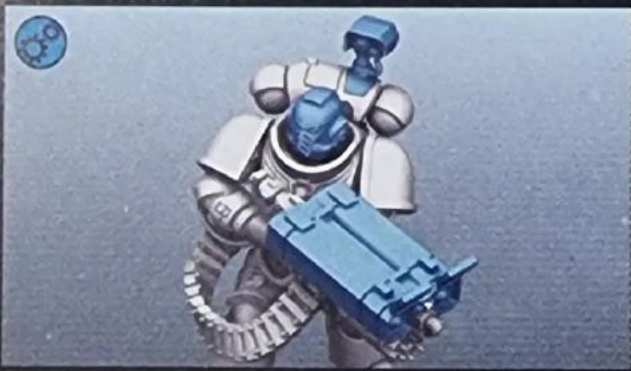





2 c

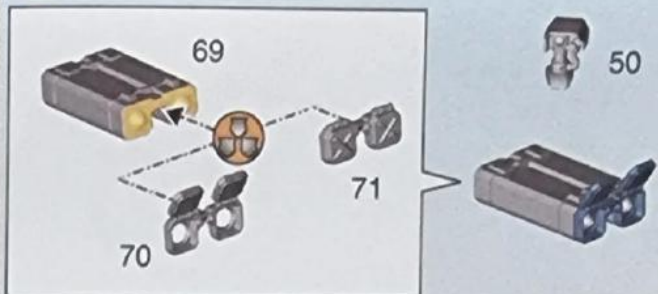

2 b

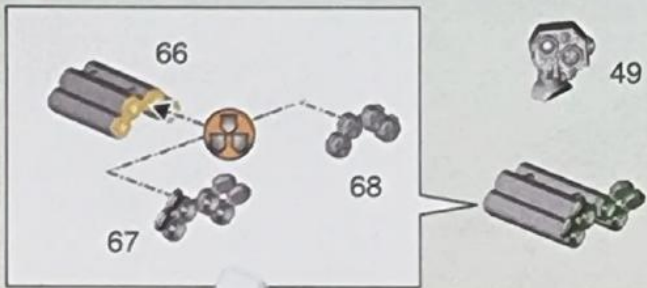

✓ 1



✓ 2





3 a

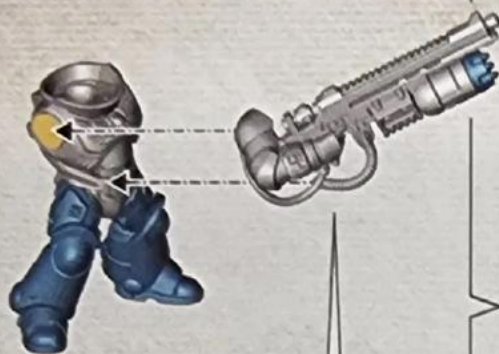

3 b

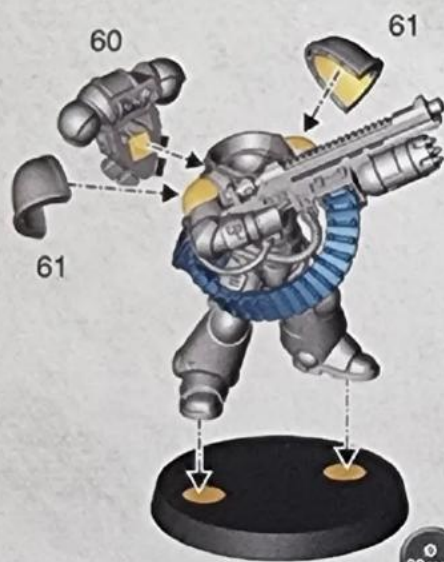
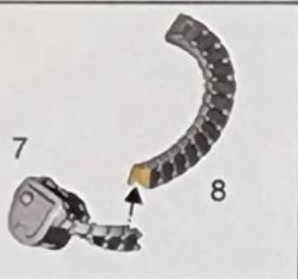

3 a



! 3 c





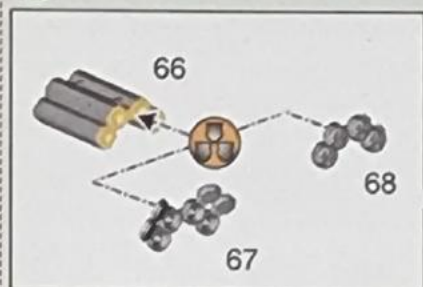
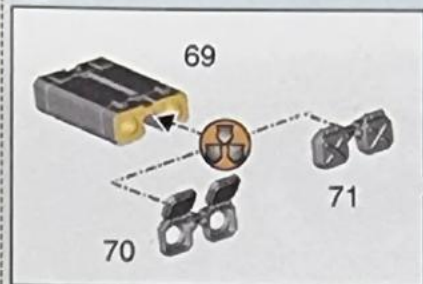

3 c

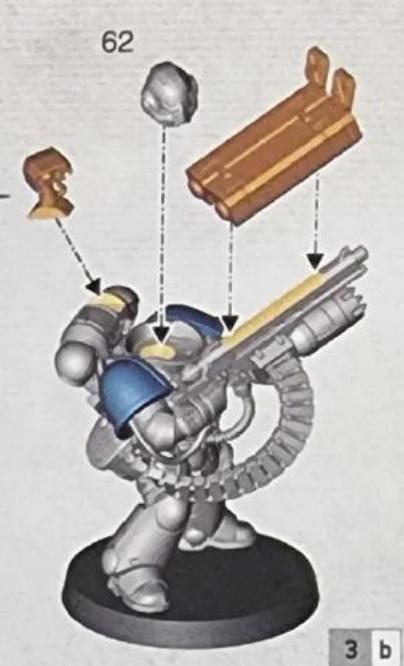

4 a

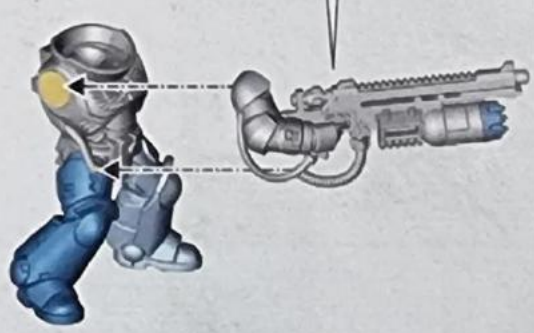
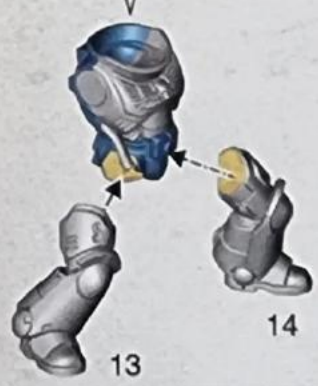
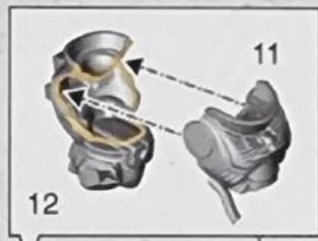

4 b

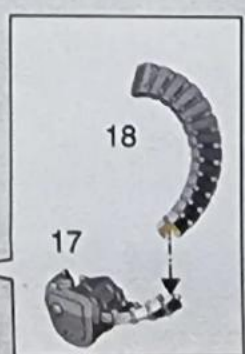

Ø 32mm





! X

! G

69 70 71 20

66 67 68 19

 This section contains two sub-diagrams. The top one shows a blue and grey component being assembled from parts 69, 70, 71, and 20. The bottom one shows a grey and green component being assembled from parts 66, 67, 68, and 19.

4 b

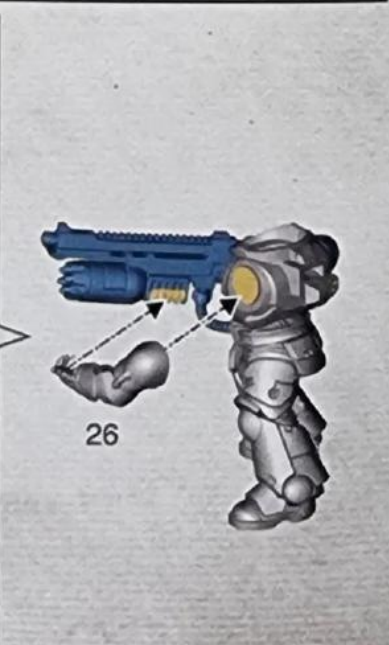
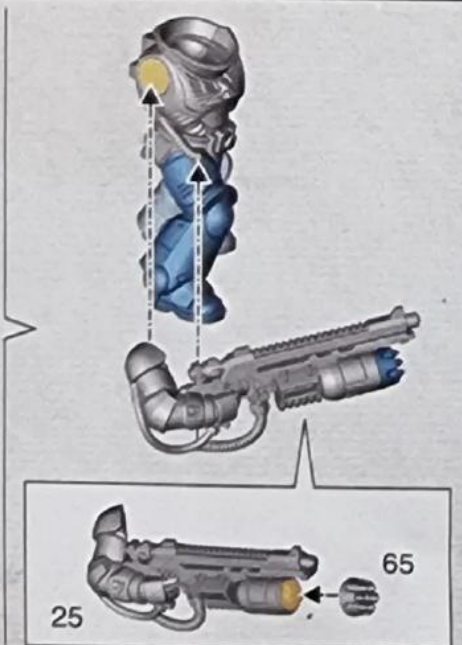
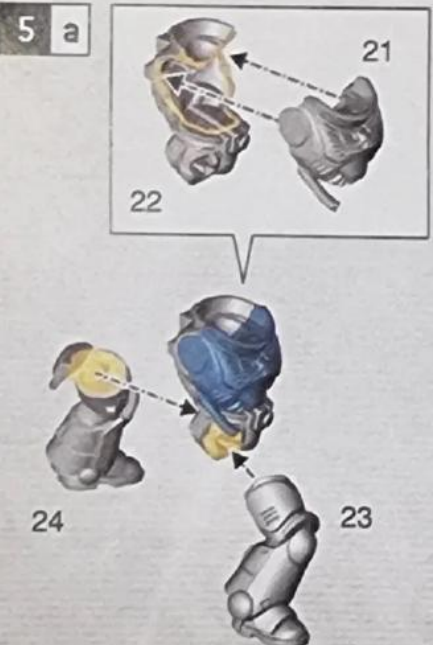

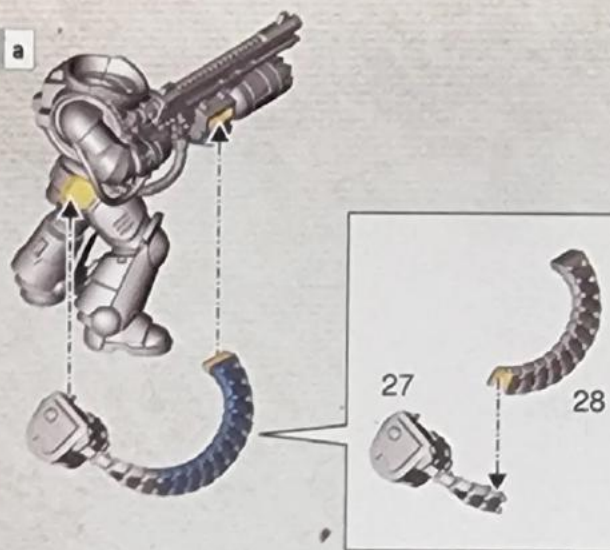

**5 b****5 a**

60

61

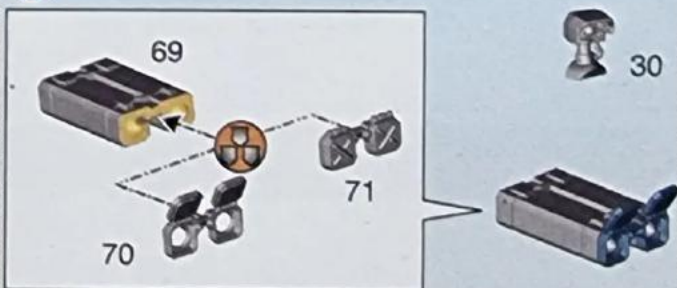
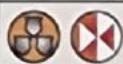
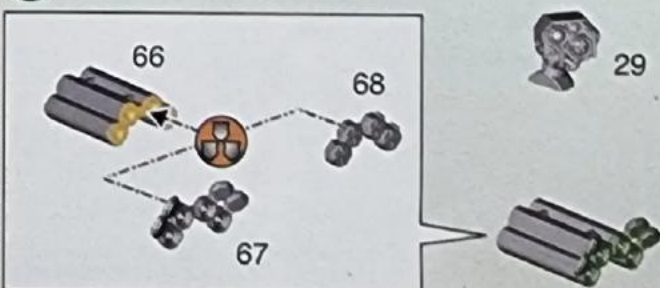
**! 5 c****5 c**

62

**5 b**

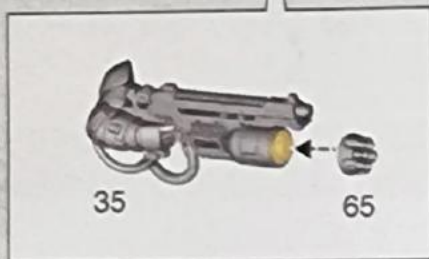
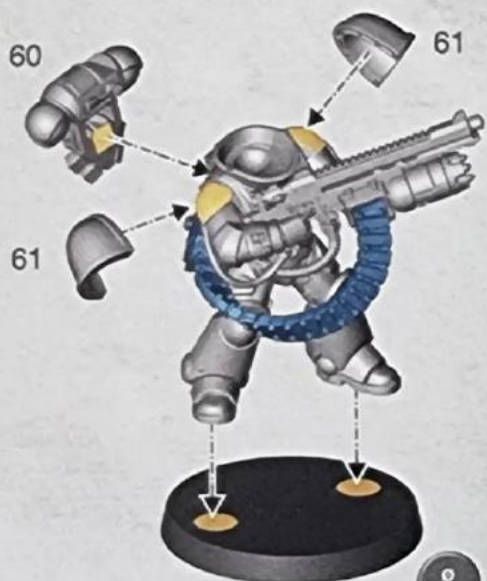

**6 a****6 b****6 a**
**6 c**



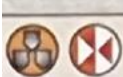

6 c

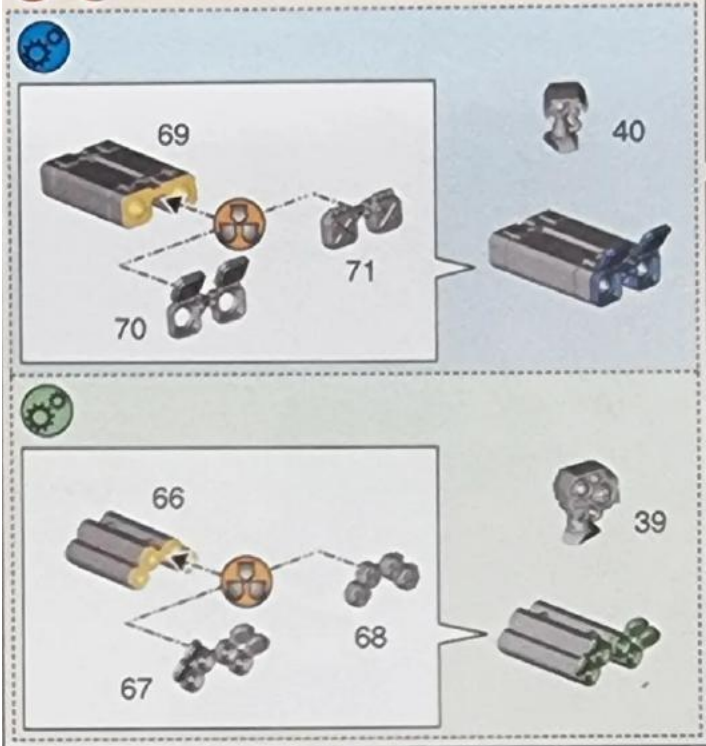

6 b

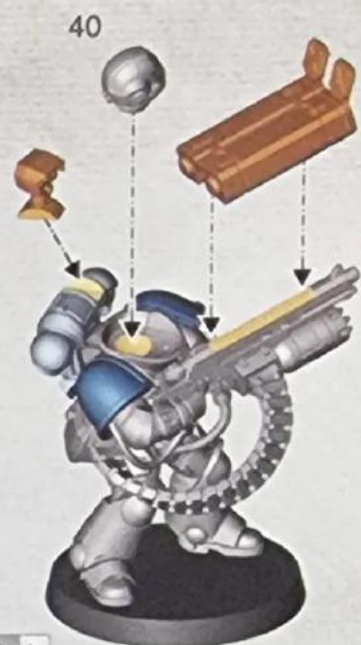

3-6



7 x5



1-6

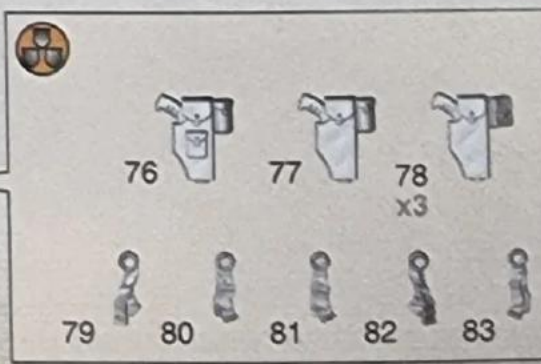









ENG More painting guides can be found on [citadelcolour.com](http://citadelcolour.com)  
FRE D'autres guides de peinture sont disponibles [citadelcolour.com](http://citadelcolour.com)  
SPA Encontrarás más guías de pintura en [citadelcolour.com](http://citadelcolour.com)  
GER Weitere Bemalanleitungen auf [citadelcolour.com](http://citadelcolour.com)

ITA Puoi trovare altre guide alla pittura su [citadelcolour.com](http://citadelcolour.com)  
日本語 [citadelcolour.com](http://citadelcolour.com) には他にも様々なペイントガイドが掲載されている  
中文 更多涂装指南请至 [citadelcolour.com](http://citadelcolour.com)

CITADEL  
COLOUR





**ENG** Used alongside the core rules found on [warhammer40000.com](http://warhammer40000.com), the following essential rules will get your new unit on the battlefield. For the full rules for this unit, see the Codex relevant to your army.

**FRE** Utilisées avec les règles de base disponibles sur [warhammer40000.com](http://warhammer40000.com), les règles essentielles qui suivent vous permettront de jouer votre nouvelle unité. Pour connaître les règles complètes de cette unité, consultez le Codex correspondant à votre armée.

**SPA** Usadas junto con las reglas básicas que encontrarás en [warhammer40000.com](http://warhammer40000.com), las siguientes reglas esenciales te permiten desplegar esta nueva unidad en el campo de batalla. Para ver las reglas completas de esta unidad, consulta el Codex correspondiente a tu ejército.

**GER** Mit den Grundregeln auf [warhammer40000.com](http://warhammer40000.com) und den folgenden grundlegenden Regeln kannst du deine neue Einheit direkt auf das Schlachtfeld führen. Die vollständigen Regeln für diese Einheit findest du im Codex deiner Armee.

**ITA** Con le seguenti regole fondamentali, usate assieme alle regole base che puoi trovare su [warhammer40000.com](http://warhammer40000.com), potrai schierare in campo la tua nuova unità. Per le regole complete di questa unità vedi il codex della tua armata.

**日本語** [warhammer40000.com](http://warhammer40000.com)に掲載されているコアルールと一緒に使用することで、以下の簡易版ルールでこのユニットを戦場で使用することができます。このユニットの完全版ルールについては、アーミーに対応したコデックスを参照してください。

**中文** 与 [warhammer40000.com](http://warhammer40000.com) 上的核心规则一起使用。以下基本规则适用于您在战场上的新单位。有关该单位的完整规则，请参阅与您的军队相关的圣典。

## DESOLATION SQUAD

ESCUADE DESOLATOR | ESCUADRA DE DESOLADORES | DESOLATORTRUPP | SQUADRA DESOLATORI  
 デソレイション・スカッド | 寂滅小队

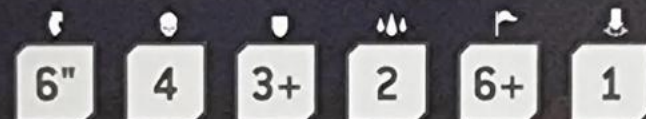

1	[PISTOL]	12"	1	3+	4	0	1	
2	[BLAST] [INDIRECT FIRE]	36"	D3	3+	4	0	1	
3	[BLAST] [HEAVY]	48"	D6+1	4+	5	0	1	
4	[HEAVY]	48"	1	4+	10	-2	D6+1	
5	[BLAST] [INDIRECT FIRE]	48"	D6	2+	7	-1	2	

	3	3+	4	0	1		

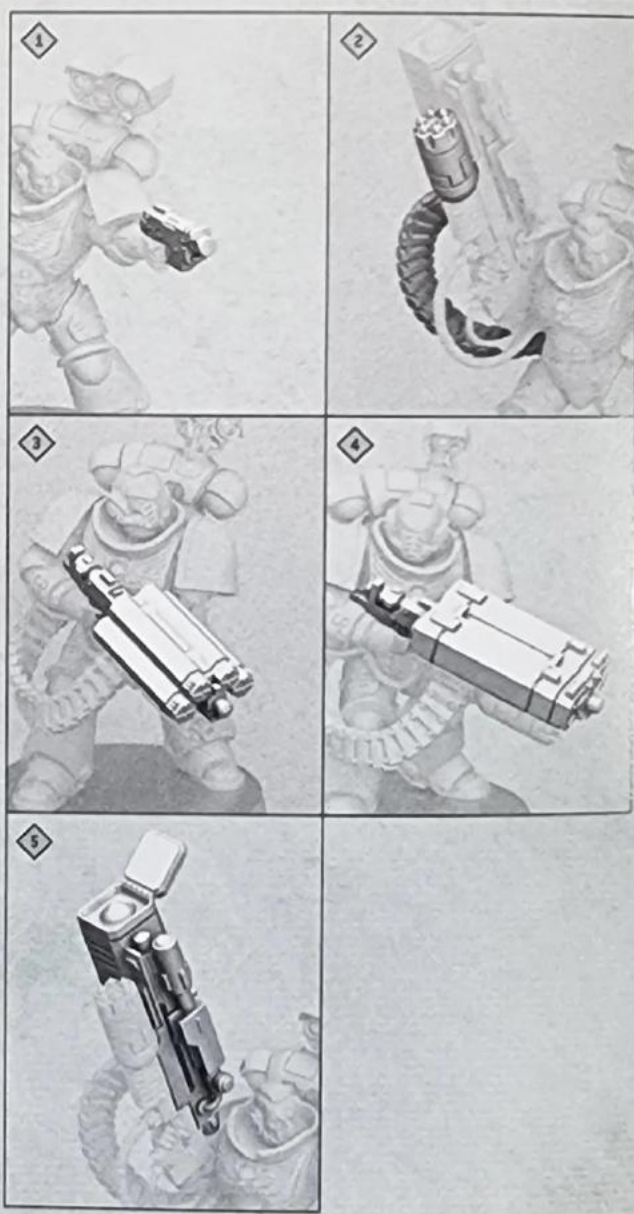

**WARHAMMER.COM**

Games Workshop Limited, Willow Road,  
 Nottingham, NG7 2WS, UK

© Copyright Games Workshop Limited 2023.

