

Free Downloads of Build Instructions,  
Assembly Booklets & How To Guides

**BuildInstructions.com**

# WARHAMMER 40,000



## DEATHWATCH VETERANS

DEATHWATCH : VÉTÉRANS | DEATHWATCH VETERANOS | VETERANEN  
DEATHWATCH: VETERANI | デスウォッチ:ベテラン | 死亡守望 老兵



READ THIS FIRST | À LIRE EN PRIORITÉ | BITTE BEACHTE | LEE ESTO PRIMERO | LEGGI PRIMA QUESTO  
最初にお読みください。 | 请优先阅读

**ENG** BEFORE ASSEMBLING YOUR MINIATURES, PLEASE READ THROUGH THE INSTRUCTIONS IN THIS BOOKLET CAREFULLY. A pair of plastic cutters is required to remove the plastic components in this kit from their frame. We advise using a mouldline scraping tool to clean up the parts. To assemble your model you will need plastic glue. Games Workshop sells Citadel Fine Detail Cutters, Citadel Mouldline Remover and Citadel Plastic Glue, but does not recommend these products for use by children under the age of 16 without adult supervision.

**FRE** AVANT D'ASSEMBLER VOS FIGURINES, VEUILLEZ LIRE ATTENTIVEMENT LES INSTRUCTIONS DE CE LIVRET. Une pince coupante est requise pour détacher chaque élément de sa grappe. Nous vous recommandons l'utilisation d'un grattoir pour ébarber les éléments. Pour l'assemblage, vous aurez également besoin de colle plastique. Games Workshop commercialise les Pinces de Précision Citadel, l'Ébarboir Citadel et la Colle Plastique Citadel, mais n'en recommande pas l'utilisation pour des enfants de moins de 16 ans sans la supervision d'un adulte.

**ESP** POR FAVOR, LEE CUIDADOSAMENTE ESTE LIBRETO DE INSTRUCCIONES ANTES DE EMPEZAR A MONTAR LAS MINIATURAS. Te harán falta unas tenazas para plástico a fin de separar las piezas de la matriz. También aconsejamos una herramienta para rebabas a fin de limpiar cada pieza. Para montar la miniatura necesitarás pegamento para plástico. Games Workshop vende Tenazas Citadel, Herramientas para rebabas Citadel y Pegamento para plástico Citadel, pero no recomienda estos productos a menores de 16 años sin la supervisión de un adulto.

**GER** VOR DEM ZUSAMMENBAU DER MINIATUREN BITTE DIE ANWEISUNGEN IN DIESER ANLEITUNG AUFMERKSAM DURCHLESEN. Du benötigst einen Kunststoffseitenschneider, um die Kunststoffbauteile aus dem Gussrahmen herauszutrennen, und Kunststoffkleber, um die Miniatur zusammenzubauen. Außerdem empfehlen wir, die Bauteile vorher mit einem Gussgratentferner zu säubern. Games Workshop bietet Präzisions-Kunststoffseitenschneider von Citadel sowie Citadel-Kunststoffkleber an, empfiehlt aber, dass Kinder unter 16 Jahren diese nur unter Aufsicht eines Erwachsenen benutzen.





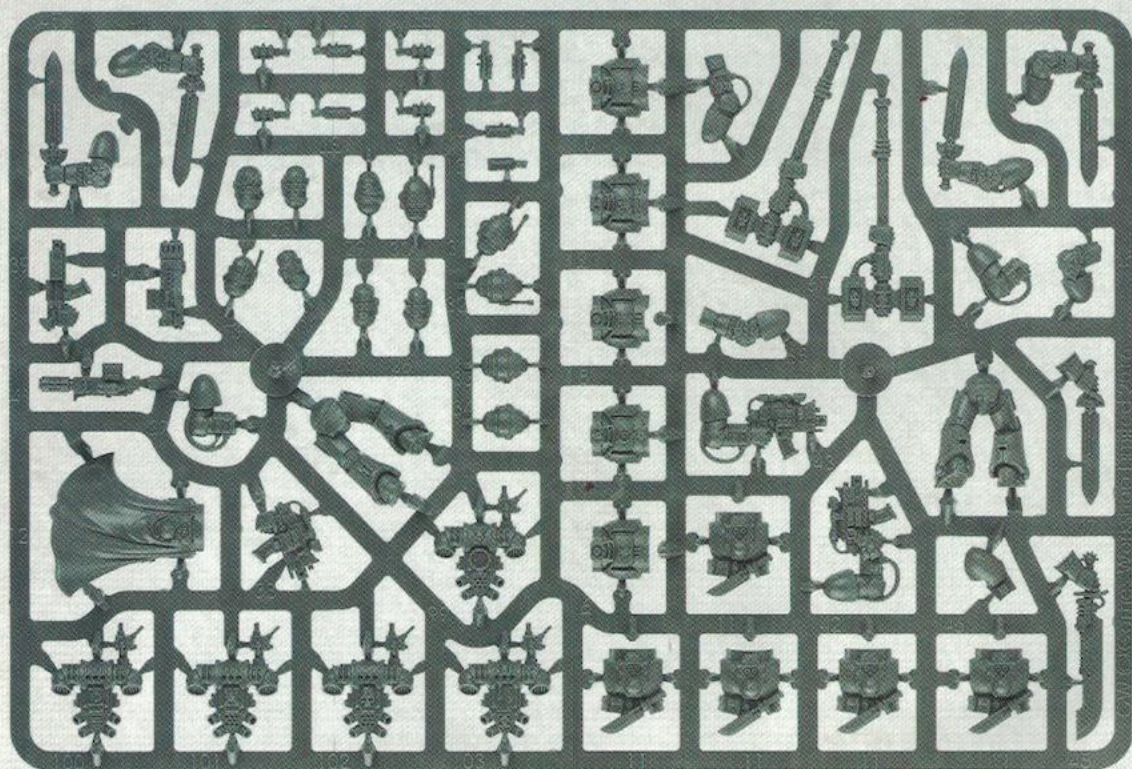
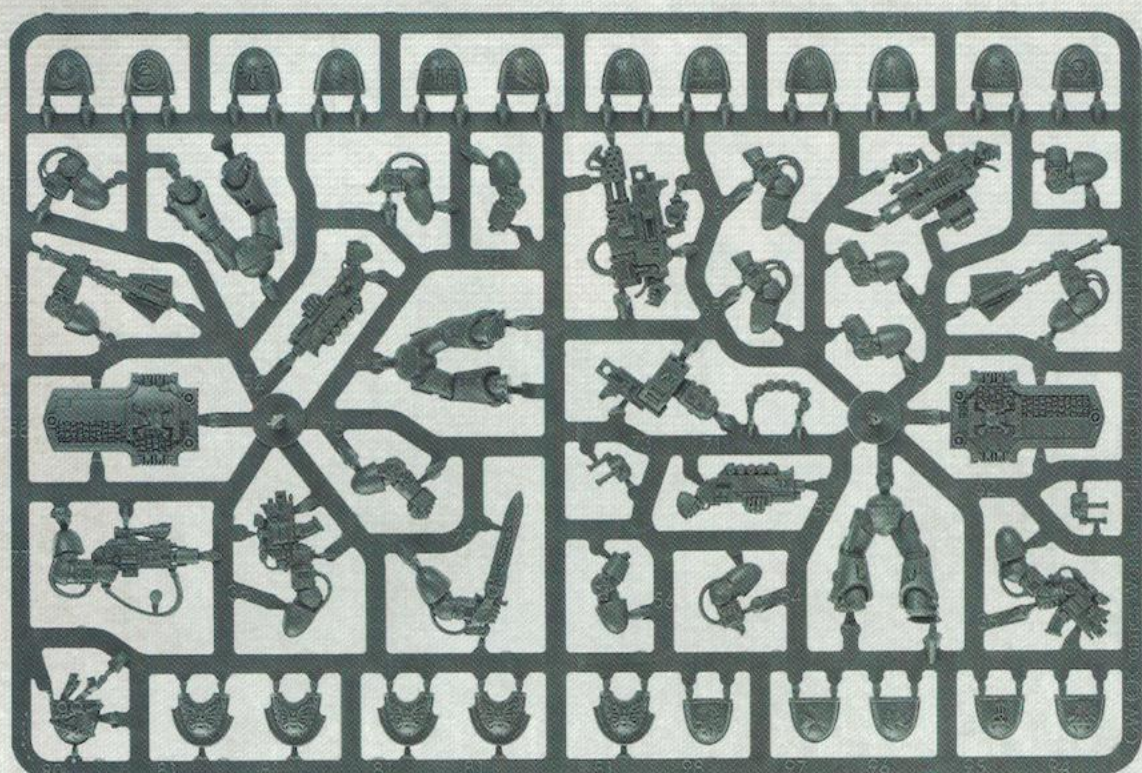

**ITA** PRIMA DI ASSEMBLARE LE TUE MINIATURE LEGGI ATTENTAMENTE TUTTE LE ISTRUZIONI DI QUESTO LIBRETTO. Sono necessarie un paio di tronchesine per plastica per staccare i componenti dai loro sprue. Consigliamo di usare un attrezzo apposito per pulire i componenti. Per assemblare il modello avrai bisogno di colla per plastica. Games Workshop vende Tronchesine di precisione Citadel, Attrezzo per ripulire Citadel e Colla per plastica Citadel, ma non consiglia questi prodotti ad un pubblico minore di 16 anni senza la supervisione di un adulto.

**日本語** 本キット内のフレームからプラスチックパーツを切り離すためには、ニッパーが必要です。パーツのモールドを平らにするには、専用ツールの使用をお勧めいたします。本キットの組み立てには、プラ用接着剤が必要です。ゲームズワークショップはシタデル・ニッパー、プラ用接着剤、シタデル・モールドラインリムーバーを販売しておりますが、16歳以下の子供が大人の監督なしにこれらの道具を使用されることをお勧めしません。

**中文** 你需要一把模型剪将塑料部件从板上剪下来。我们建议使用分模线刮刀来处理零件。组装时你还需要用到模型胶水。你可以从 Games Workshop 处购买到 Citadel Fine Detail Cutter 模型剪、Citadel Mouldline Remover 分模线刮刀和 Citadel Plastic Glue 模型胶，但 16 岁以下儿童不得在没有成年人监护的情况下使用这些产品。



Ø 32mm x5

- |   |  |  |
|---|--|--|
| <ul style="list-style-type: none"> <li> • Variant assembly</li> <li>• Variante d'assemblage</li> <li>• Variante de montaje</li> <li>• Bauvariante</li> <li>• Assemblaggio alternativo</li> <li>• 組み立てバリエーション</li> <li>• 多种组装方式</li> </ul>  | <ul style="list-style-type: none"> <li> • Choice of parts</li> <li>• Choix d'éléments</li> <li>• Modelos de componentes</li> <li>• Auswahl an Teilen</li> <li>• Scelta di componenti</li> <li>• パーツの選択</li> <li>• 选择部件</li> </ul> | <ul style="list-style-type: none"> <li> • Use matching parts</li> <li>• Utiliser les éléments correspondants</li> <li>• Usa las piezas que correspondan</li> <li>• Verwende die passenden Teile</li> <li>• Usa le parti corrispondenti</li> <li>• 適合するパーツを使用</li> <li>• 使用匹配部件</li> </ul> |
| <ul style="list-style-type: none"> <li> • Special instruction - Please read</li> <li>• Instructions spéciales - Lire attentivement</li> <li>• Instrucción especial: Por favor, léela</li> <li>• Besondere Anweisung - Bitte lesen</li> <li>• Istruzioni speciali - Leggi attentamente</li> <li>• 特記事項 - 必ずお読みください</li> <li>• 特殊说明 - 请详阅</li> </ul> | <ul style="list-style-type: none"> <li> • Repeat process</li> <li>• Répéter l'étape</li> <li>• Repetir pasos</li> <li>• Vorgang wiederholen</li> <li>• Ripeti il processo</li> <li>• 同じ作業を繰り返すこと</li> <li>• 重复步骤</li> </ul>       | <ul style="list-style-type: none"> <li> • Stage complete</li> <li>• Étape terminée</li> <li>• Paso completado</li> <li>• Schritt abgeschlossen</li> <li>• Fase completa</li> <li>• このステージの完成</li> <li>• 完成</li> </ul>  |

 BUILD VARIANTS | VARIANTES D'ASSEMBLAGE | MONTATERNATIVOS |  
 BAUVARIANTEN VARIANTI D'ASSEMBLAGGIO | バリエーション | 变体版

- |   |  |
|---|--|
| <ul style="list-style-type: none"> <li> • Assemblies for build variants are colour coded.</li> <li>• Les assemblages de variantes ont un code couleur.</li> <li>• Las instrucciones para montajes alternativos se indican con un color diferente.</li> </ul> | <ul style="list-style-type: none"> <li>• Optionen für Bauvarianten sind farblich markiert.</li> <li>• Le diverse varianti d'assemblaggio sono divise per colore.</li> <li>• バリエーション違いの組み立ては色分けされている。</li> <li>• 变体版拼装部件有颜色区分。</li> </ul> |
|---|--|

Deathwatch Veterans  
 Deathwatch : Vétérans  
 Deathwatch Veteranos  
 Veteranen  
 Deathwatch: Veterani  
 デスウォッチ:ベテラン  
 死亡守望 老兵



 STEPS | ÉTAPES | PASOS | SCHRITTE | FASI | ステップ | 步骤 **1 - 6**

Black Shield  
 Écu Noir  
 Escudo Negro  
 Schwarzschild  
 Scudo Nero  
 ブラックシールド  
 黑盾



 STEPS | ÉTAPES | PASOS | SCHRITTE | FASI | ステップ | 步骤 **7**

1 a x5



13 14 15 16 17



18 19 20 21 22

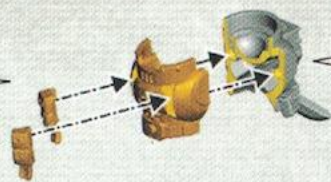

6



7



8



9



10

1 b x5

1 a



32mm



1

2



3

4

5



INTERCHANGEABLE PARTS | ÉLÉMENTS INTERCHANGEABLES | PARTES INTERCAMBIABLES |  
AUSTAUSCHBARE TEILE | COMPONENTI INTERCAMBIABILI | 組み換え可能な部品 | 可互換零件

1 c



99



100



101



102



103

1 d



82



83



84



85



86



87



88



89



90



91



92



93



94



95



96



97



98

1 e



23



24



25



26



27



28



29



30



31



32



33



34

2 a



2 b

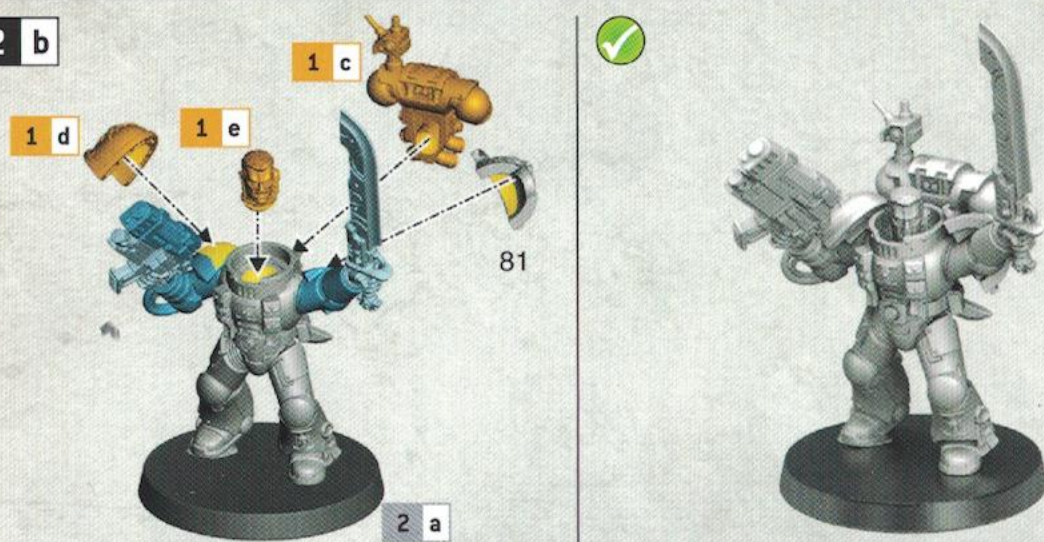

3

VETERAN A

3 a



3 b



3 c



3 a

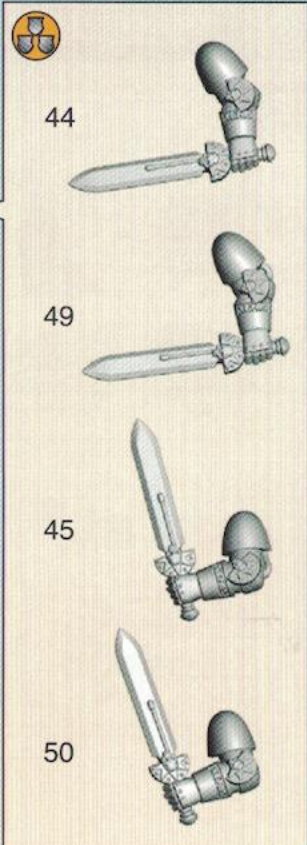
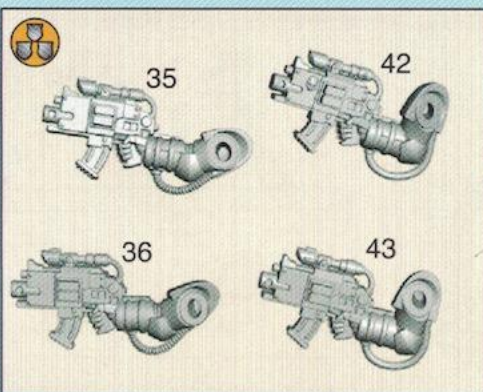

3 b

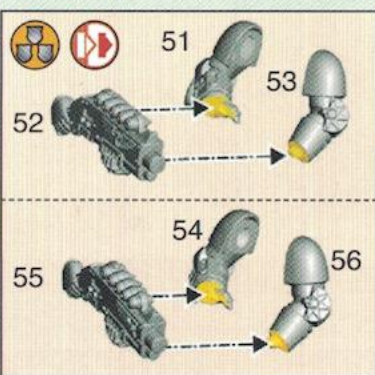

3 c

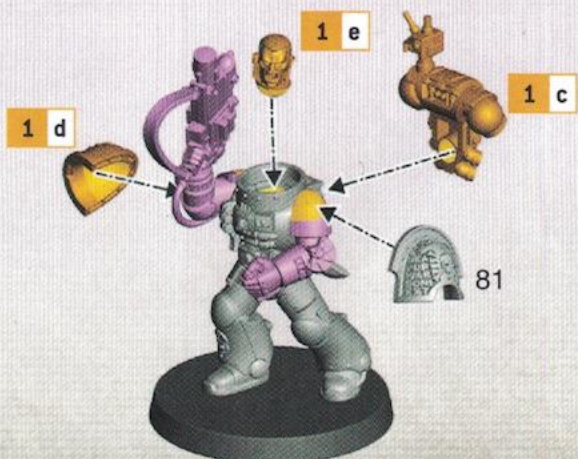

4 a



4 b



4 a

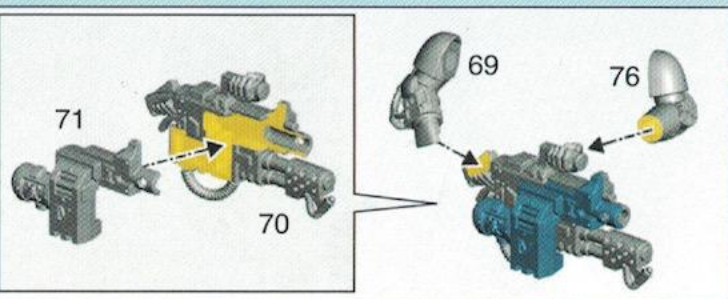

4 b

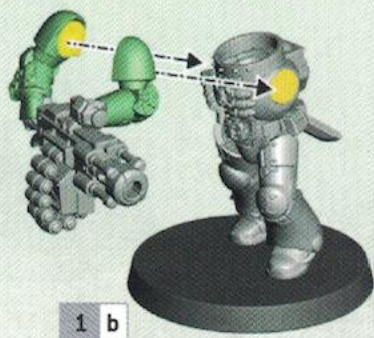
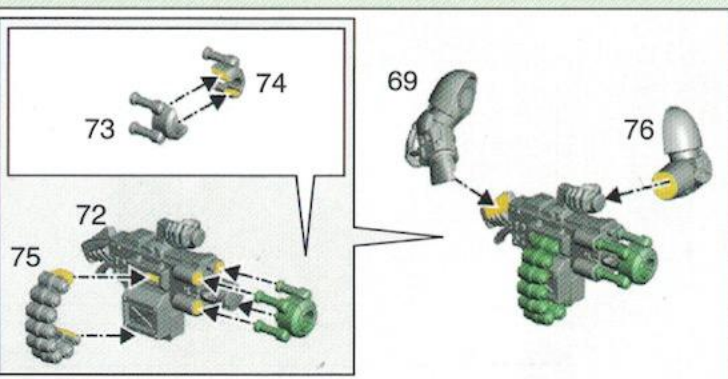

4 c





5 a



5 b



5 a

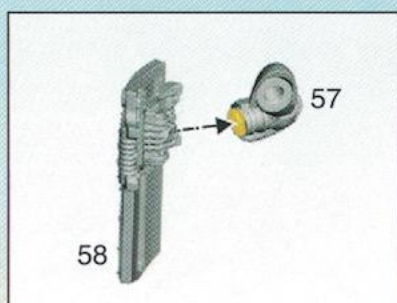

5 b

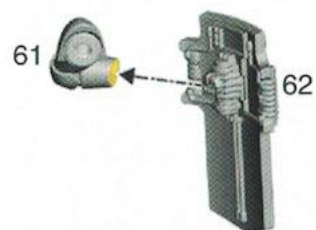

5 c

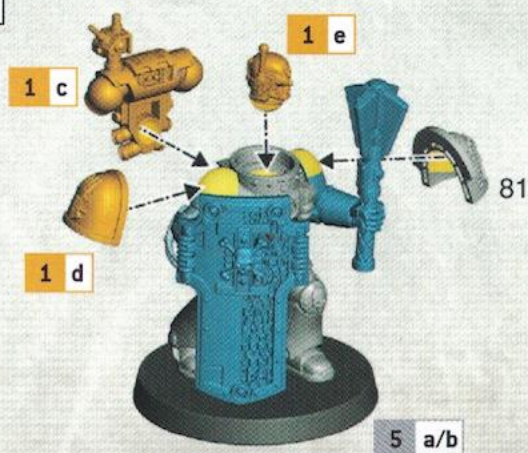

6 a



6 b



6 a

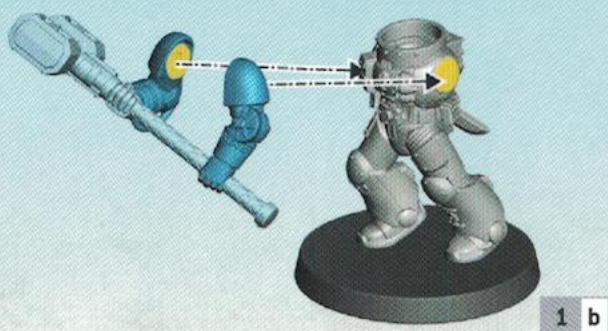
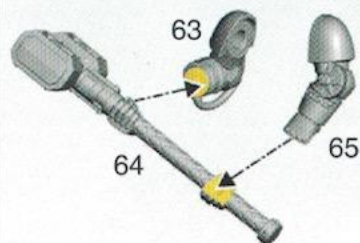

6 b

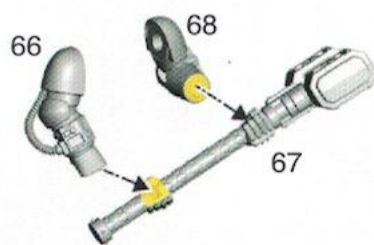
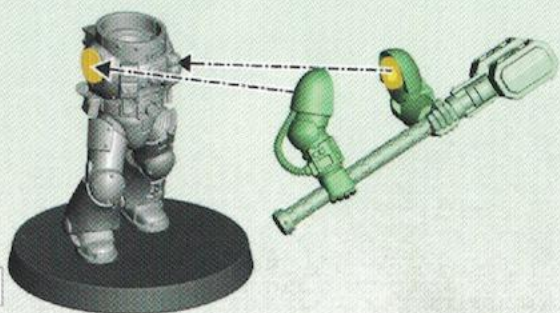

6 c

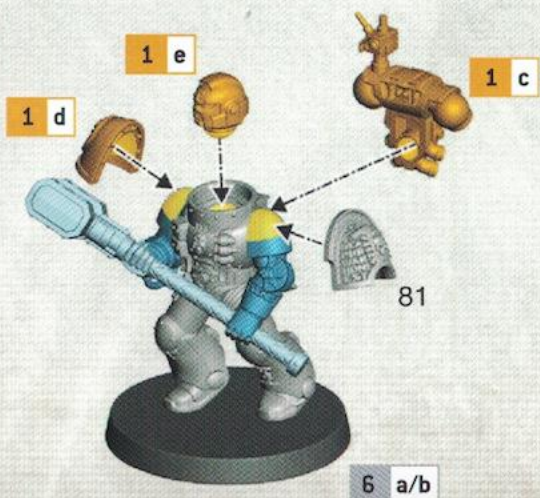

7 a



13 14 15 16 17



18 19 20 21 22



6



7



8



9



10

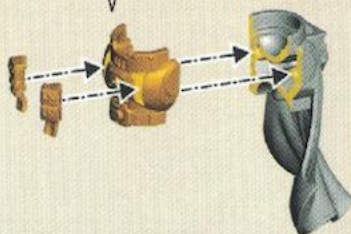

7 b



∅ 32mm

7 a

7 c



7 b

7 d



7 c



44



49



45



50



7 e



1 c

29

7 d





**ENG** The full painting guide can be found on [citadelcolour.com/guides](http://citadelcolour.com/guides)

**FRE** Le guide de peinture complet est disponible sur [citadelcolour.com/guides](http://citadelcolour.com/guides)

**ESP** Puedes encontrar la guía completa de pintura en [citadelcolour.com/guides](http://citadelcolour.com/guides)

**GER** Die vollständige Bemalanleitung findest du auf [citadelcolour.com/guides](http://citadelcolour.com/guides)

**ITA** Puoi trovare la guida completa alla pittura su [citadelcolour.com/guides](http://citadelcolour.com/guides)

**日本語** ペイントの完全版ガイドは [citadelcolour.com](http://citadelcolour.com) に掲載されている。

**中文** 可以在 [citadelcolour.com/guides](http://citadelcolour.com/guides) 找到完整涂装指南。





**ENG** Used alongside the core rules found on [warhammer40000.com](http://warhammer40000.com), the essential rules below will get your new unit on the battlefield. For the full rules for this unit, see the Codex relevant to your army.

**FRE** Utilisées avec les règles de base de [warhammer40000.com](http://warhammer40000.com), les règles essentielles ci-dessous vous permettront de jouer votre nouvelle unité sur le champ de bataille. Pour les règles complètes de cette unité, référez-vous au Codex correspondant à votre armée.

**ESP** Usadas junto a las reglas básicas que encontrarás en [warhammer40000.com](http://warhammer40000.com), las siguientes reglas esenciales pondrán tu nueva unidad en el campo de batalla. Para ver las reglas completas de esta unidad, consulta el Codex de tu ejército.

**GER** Wenn du die Regeln unten zusammen mit den Grundregeln auf [warhammer40000.com](http://warhammer40000.com) verwendest, kannst du deine Einheit

direkt auf das Schlachtfeld führen. Die vollständigen Regeln für diese Einheit findest du im entsprechenden Codex für deine Armee.

**ITA** Usate assieme alle regole base che puoi trovare su [warhammer40000.com](http://warhammer40000.com), le regole essenziali in basso ti aiuteranno a portare sul campo di battaglia la tua nuova unità. Per le regole complete di questa unità, consulta il Codex corrispondente alla tua armata.

**日本語** [warhammer40000.com](http://warhammer40000.com)に掲載されているコアルールとともに以下のユニット用基本ルールを使用することで、このユニットを戦場に配備することができます。このユニットの完全版ルールについては、このユニットが属するアーミーのコーデックスを参照してください。

**中文** 下方的基本规则需搭配 [warhammer40000.com](http://warhammer40000.com) 上的《核心规则》使用，可助您将新单位部署到战场上。有关该单位的完整规则，请参见与您的军队相关的《圣典》。

## VETERANS

DEATHWATCH: VÉTÉRANS | DEATHWATCH VETERANOS | VETERANEN | DEATHWATCH: VETERANI |  
デスウォッチ:ベテラン | 死亡守望 老兵

Veteran	6"	3+	3+	4	4	2	2	8 3+
Watch Sergeant	6"	3+	3+	4	4	2	3	9 3+
Black Shield	6"	2+	3+	4	4	2	3	8 3+

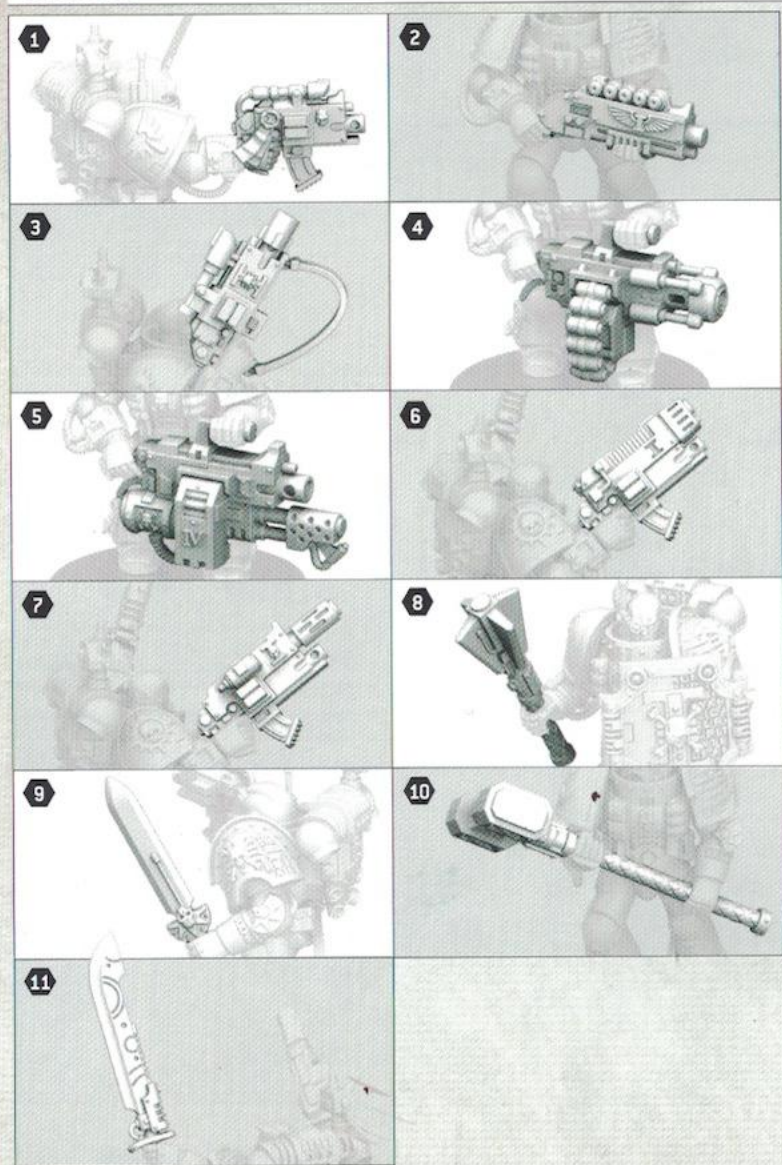

1	24"	1	4	0 1
	18"	2	5	0 1
2	8"	D6	4	0 1
	12"	2	4	-1 2
3	30"	1	4	-2 2
	12"	2D3	6	-1 1
4	24"	2	7	-2 2
5	36"	3	5	-1 2
	12"	D6	5	-1 1
6	24"	1	4	0 1
	24"	1	7	-3 1
7	24"	1	4	0 1
	12"	1	8	-4 D6
8			+3	-1 1
9			+1	-3 1
10			x2	-3 4
11			+1	-4 1



993201090010



warhammer.com

Games Workshop Limited, Willow Road,  
Nottingham, NG7 2WS, UK

© Copyright Games Workshop Limited 2020.

