

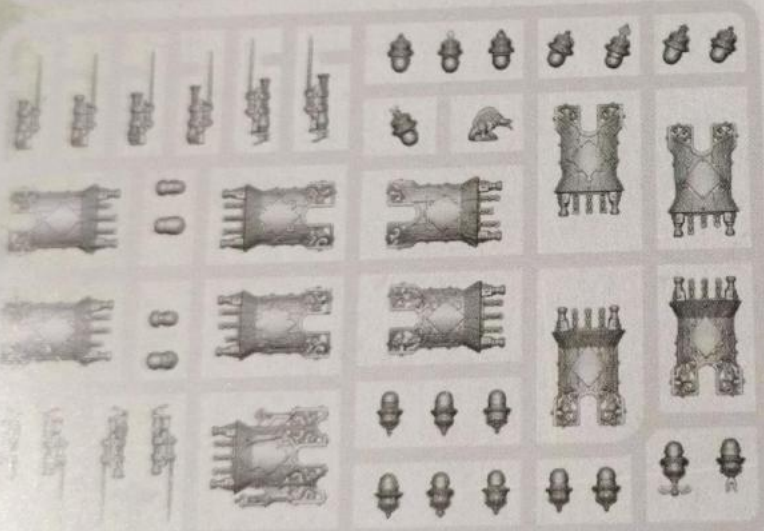

Free Downloads of Build Instructions,
Assembly Booklets & How To Guides

BuildInstructions.com



BUILD VARIANTS • VARIANTES D'ASSEMBLAGE • VARIANTES DE MONTAJE • BAUVARIANTEN
 VARIANTI D'ASSEMBLAGGIO • パリエーション • 変体版

- Assemblies for build variants are colour coded.
- Les assemblages de variantes ont un code couleur.
- Las instrucciones para montajes alternativos se indican con un color diferente.
- Optionen für Bauvarianten sind farblich markiert.
- Le diverse varianti d'assemblaggio sono divise per colore.
- パリエーション違いの組み立ては色分けされている。
- 変体版拼装部件有颜色区分。



! • Special instruction - Take care • Instruction spéciale - Faites attention • Instrucciones especiales - Presta atención
 • Besondere Anweisung - bitte beachten • Istruzioni speciali: prestare attenzione • 特記事項 - 要注意 • 特别说明 - 小心

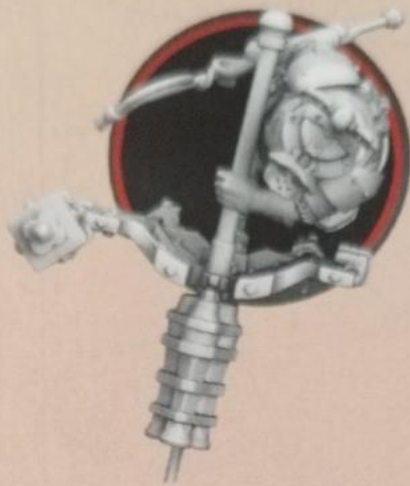

1:1

CITADEL COLOUR



1

• Interchangeable parts • Éléments interchangeables • Partes intercambiables • Austauschbare Teile
• Componenti intercambiabili • 組み換え可能な部品 • 可互换零件

1 a



1 b



1 c

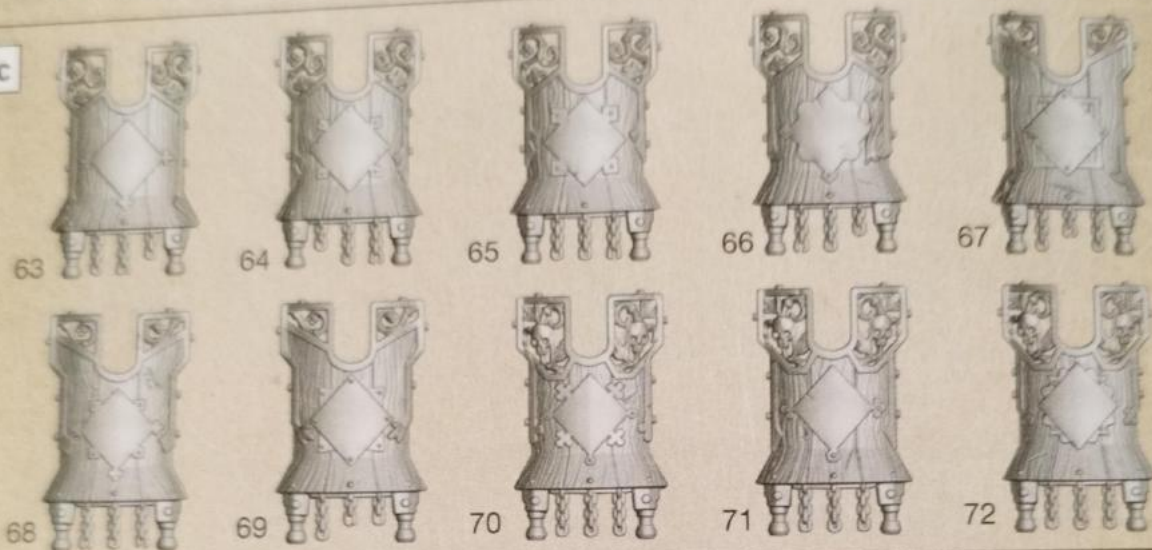

2

• Choose the variant you want to build
• Choisissez la variante à assembler
• Elige qué versión quieres montar
• Wähle die Variante, die du bauen möchtest

• Scegli la variante che vuoi assemblare
• 組み立てバリエーションの選択
• 选择你喜欢的拼装方式

2a-2c



• Champion • Campeón • Campione • チャンピオン • 勇士

2a; 2d - 2e



2a; 2f - 2g

• Freeguild Fusiliers
• Fusiliers des Guildes Franches
• Fusileros del Gremio Libre
• Freigilden-Füsilieri
• Fucilieri della Gilda Libera
• フリーギルド・フュージリア
• 自由兵団燧发枪士兵



2 a



2 b



34



2 c



104

103



2 d

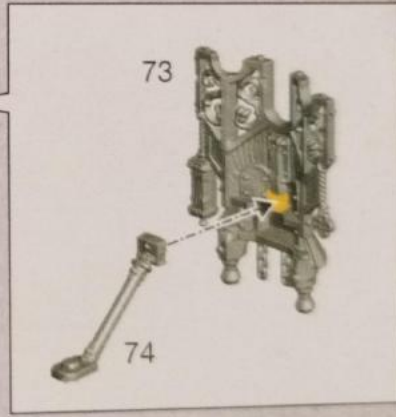

2 e

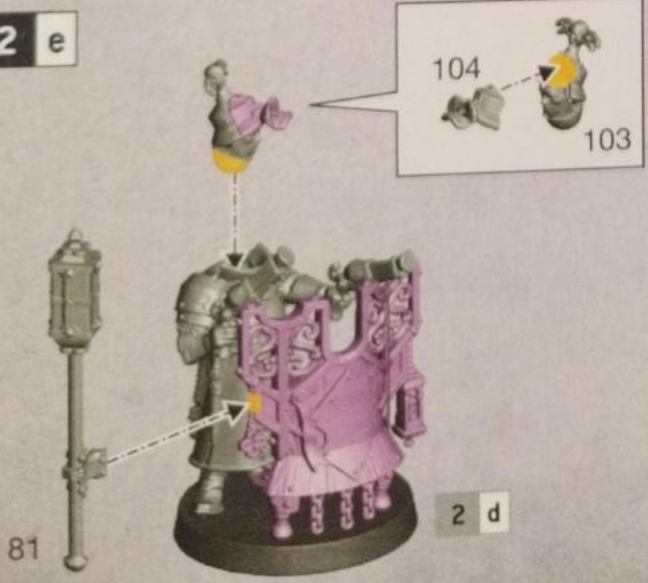

2 f

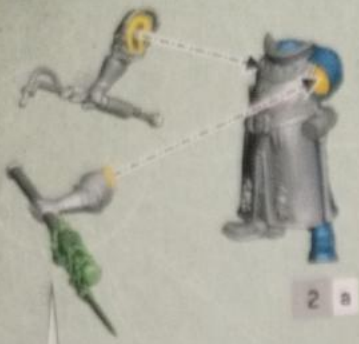

2 a

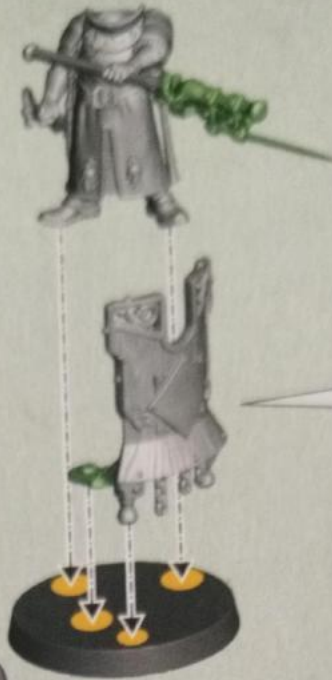
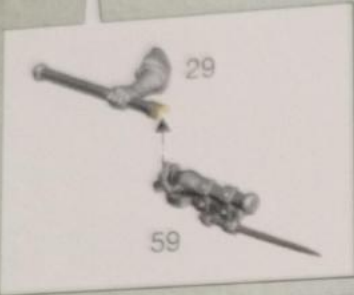

Ø 26mm

1 d

74



2 g



1 a



3



2

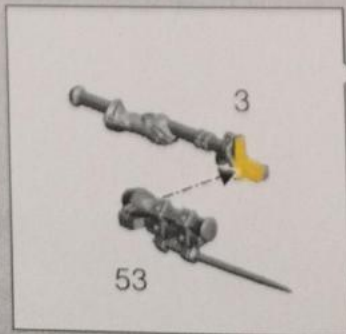

53

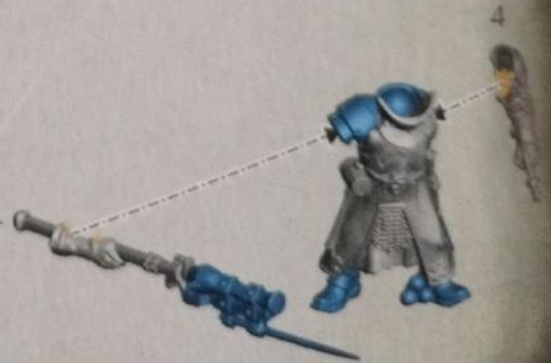

4

3 b

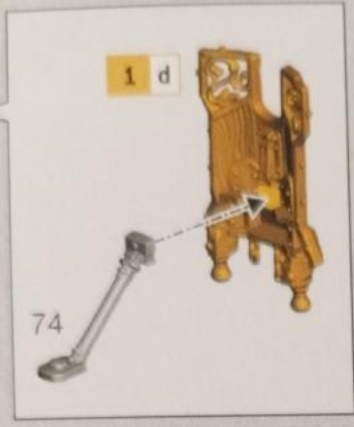

4 a

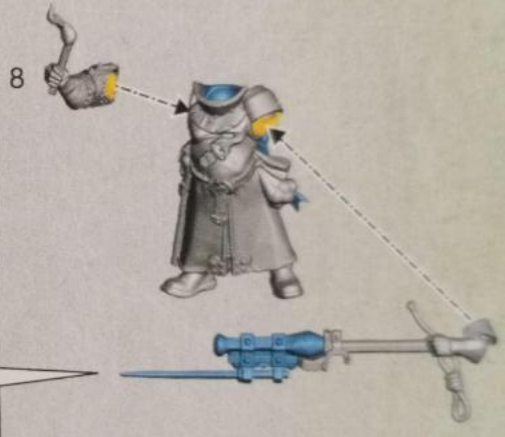
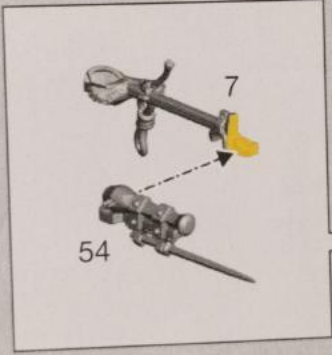

4 b

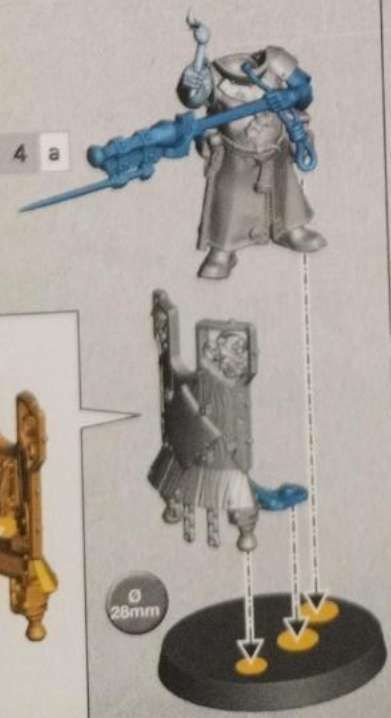

5 a

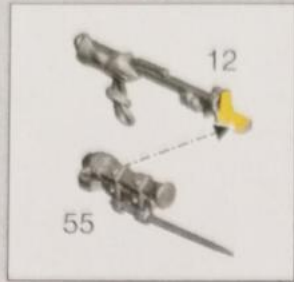

5 b



© 28mm

6 a

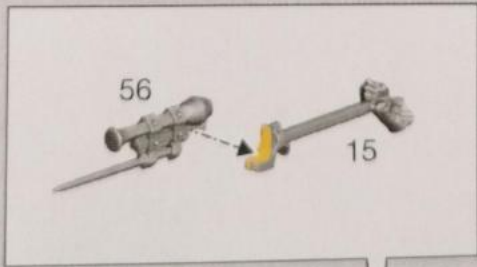

6 b

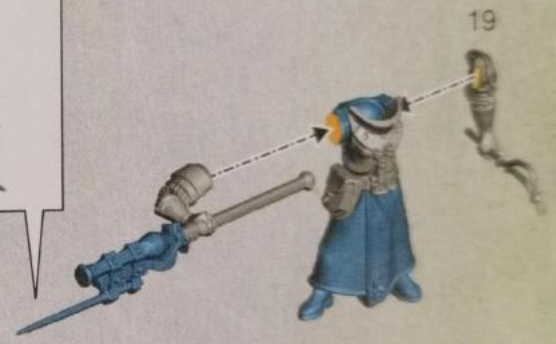
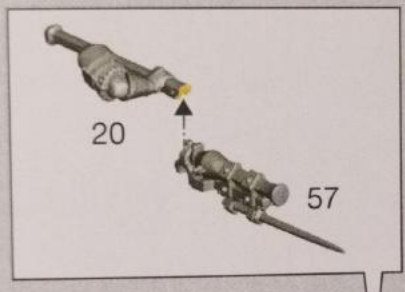

7 b

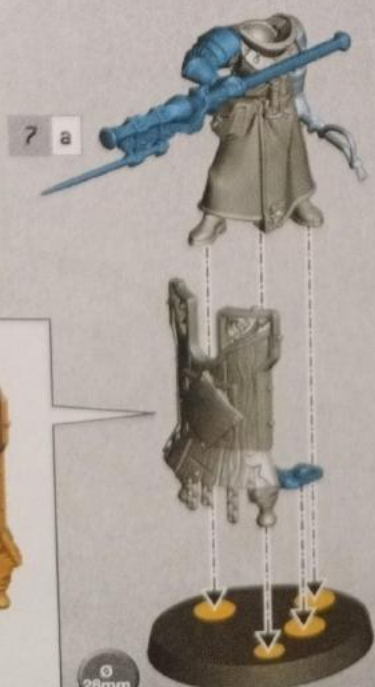

8 a

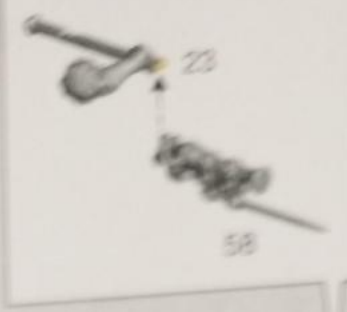

8 b



9 a

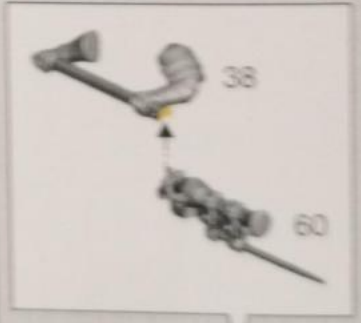

9 b



9 a

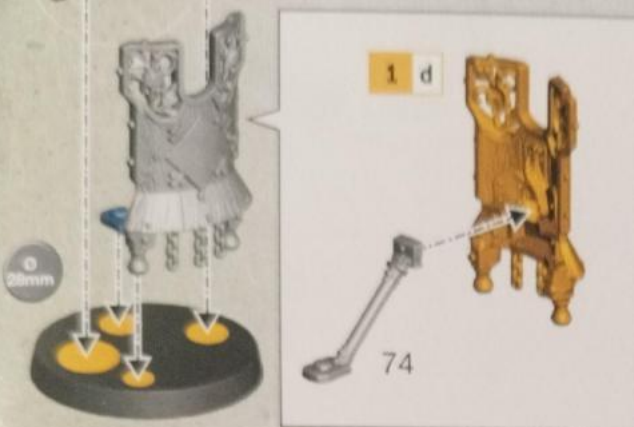

Ø 28mm

1 d

74

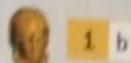

1 b



10 a



39

40



41

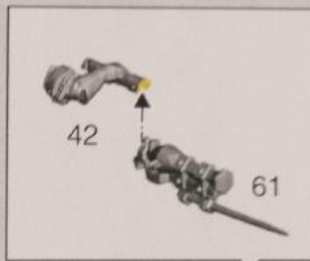

42

61



43

10 b



10 a



1 d

74

Ø 28mm

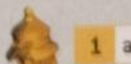

1 a



11 a

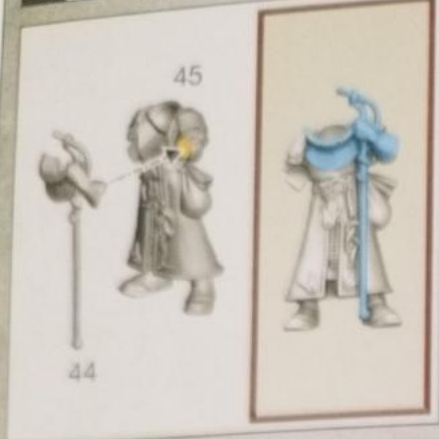

11 b

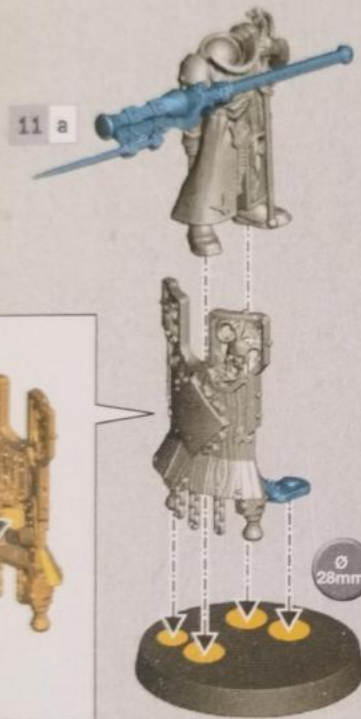

12

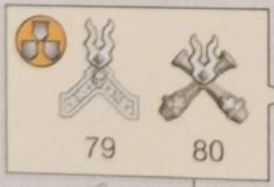

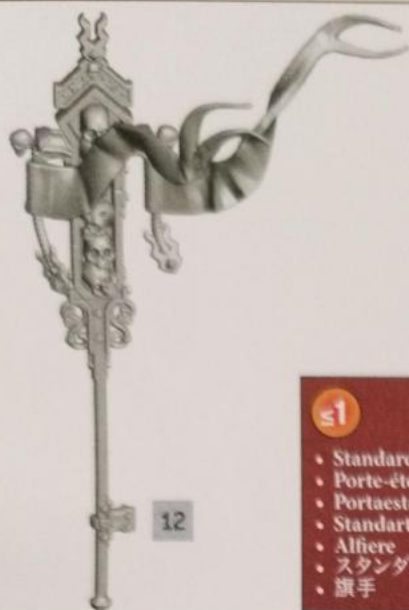

12

≤1

- Standard Bearer
- Porte-étendard
- Portaestandartes
- Standartenträger
- Alfiere
- スタンダードベアラ
- 旗手



77



78



105



106



3-12



14

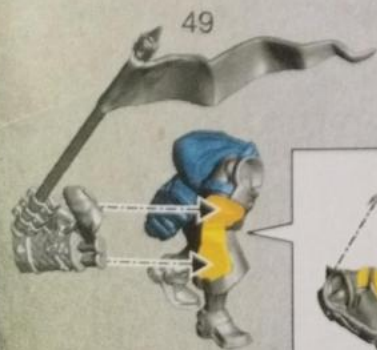

49



50

48



52

51

∅ 25mm

