



Free Downloads of Build Instructions,
Assembly Booklets & How To Guides

BuildInstructions.com

WARHAMMER 40,000

KNIGHT ABOMINANT

CHEVALIER ABOMINABLE | CABALLERO ABOMINANTE | GRAUENRITTER | KAVALLIERE ABOMINANT | ナイト・アボミナント | 憎惡騎士



! READ THIS FIRST | À LIRE EN PRIORITÉ | BITTE BEACHTE | LEE ESTO PRIMERO | LEGGI PRIMA QUESTO | 最初にお読みください。| 请优先阅读

ENG BEFORE ASSEMBLING YOUR MINIATURES, PLEASE READ THROUGH THE INSTRUCTIONS IN THIS BOOKLET CAREFULLY. A pair of plastic cutters is required to remove the plastic components in this kit from their frame. We advise using a mouldline scraping tool to clean up the parts. To assemble your model you will need plastic glue. Games Workshop sells Citadel Fine Detail Cutters, Citadel Mouldline Remover and Citadel Plastic Glue, but does not recommend these products for use by children under the age of 16 without adult supervision.

FR AVANT D'ASSEMBLER VOS FIGURINES, VEUILLEZ LIRE ATTENTIVEMENT LES INSTRUCTIONS DE CE LIVRET. Une pince coupante est requise pour détacher chaque élément de sa grappe. Nous vous recommandons l'utilisation d'un grattoir pour ébarber les éléments. Pour l'assemblage, vous aurez également besoin de colle plastique. Games Workshop commercialise les Pinces de Précision Citadel, l'Ébarboir Citadel et la Colle Plastique Citadel, mais n'en recommande pas l'utilisation pour des enfants de moins de 16 ans sans la supervision d'un adulte.

SP POR FAVOR, LEE CUIDADOSAMENTE ESTE LIBRETO DE INSTRUCCIONES ANTES DE EMPEZAR A MONTAR LAS MINIATURAS. Te harán falta unas tenazas para plástico a fin de separar las piezas de la matriz. También aconsejamos una herramienta para rebabas a fin de limpiar cada pieza. Para montar la miniatura necesitarás pegamento para plástico. Games Workshop vende Tenazas Citadel, Herramientas para rebabas Citadel y Pegamento para plástico Citadel, pero no recomienda estos productos a menores de 16 años sin la supervisión de un adulto.

GR VOR DEM ZUSAMMENBAU DER MINIATUREN BITTE DIE ANWEISUNGEN IN DIESER ANLEITUNG AUFMERKSAM DURCHLESEN. Du benötigst einen

Kunststoffseitenschneider, um die Kunststoffbauteile aus dem Gussrahmen herauszutrennen, und Kunststoffkleber, um die Miniatur zusammenzubauen. Außerdem empfehlen wir, die Bauteile vorher mit einem Gussgratentferner zu säubern. Games Workshop bietet Präzisions-Kunststoffseitenschneider von Citadel sowie Citadel-Kunststoffkleber an, empfiehlt aber, dass Kinder unter 16 Jahren diese nur unter Aufsicht eines Erwachsenen benutzen.

ITA PRIMA DI ASSEMBLARE LE TUE MINIATURE LEGGI ATTENTAMENTE TUTTE LE ISTRUZIONI DI QUESTO LIBRETTO. Sono necessari un paio di tronchesine per plastica per staccare i componenti dai loro spruc. Consigliamo di usare un attrezzo apposito per pulire i componenti. Per assemblare il modello avrai bisogno di colla per plastica. Games Workshop vende Tronchesine di precisione Citadel, Attrezzi per ripulire Citadel e Colla per plastica Citadel, ma non consiglia questi prodotti ad un pubblico minore di 16 anni senza la supervisione di un adulto.

日英 本キット内のフレームからプラスチックパーツを切り離すためには、ニッパーが必要です。パーツのモールドを平らにするには、専用ツールの使用をお勧めいたします。本キットの組み立てには、プラ用接着剤が必要です。ゲームズワークショップはシタデル・ニッパー、プラ用接着剤、シタデル・モールドラインリムーバーを販売しておりますが、16歳以下の子供が大人の監督なしにこれらの道具を使用されることをお断りします。

中 你需要一把模型鉗將塑料部件從板件上剪下來。我們建議使用分模線刮刀來處理零件。組裝時你還需要用到模型胶水。你可以從 Games Workshop 處購買到 Citadel Fine Detail Cutter 模型鉗、Citadel Mouldline Remover 分模線刮刀和 Citadel Plastic Glue 模型膠。但 16 歲以下兒童不得在沒有成年人監督的情況下使用這些產品。



- Assemblies for build variants are colour coded.
- Les assemblages de variantes ont un code couleur.
- Las instrucciones para montajes alternativos se indican con un color diferente.
- Optionen für Bauvarianten sind farblich markiert.
- Le diverse varianti d'assemblaggio sono divise per colore.
- バリエーション違いの組み立ては色分けされている。
- 変体版拼装部件有颜色区分。



- | | | | |
|---|--|--|--|
| <ul style="list-style-type: none"> Special instruction - Please read Instructions spéciales - Lire attentivement Instrucción especial: Por favor, léala Besondere Anweisung - Bitte lesen Istruzioni speciali - Leggi attentamente 特記事項 - 必ずお読みください 特殊说明 - 请详阅 | <ul style="list-style-type: none"> Variant assembly Variante d'assemblage Variante de montage Bauvariante Assemblaggio alternativo 組み立てバリエーション 多种组装方式 | <ul style="list-style-type: none"> Choice of parts Choix d'éléments Modelos de componentes Auswahl an Teilen Scelta di componenti パーツの選択 选择部件 | <ul style="list-style-type: none"> Repeat process Répéter l'étape Repetir pasos Vorgang wiederholen Ripeti il processo 同じ作業を繰り返すこと 重复步骤 |
| <ul style="list-style-type: none"> Do not glue the components Ne pas coller les éléments No pegar los componentes Bitte die Teile nicht kleben Non incollare i componenti このパーツは接着不可 请勿粘接 | <ul style="list-style-type: none"> Use matching parts Utiliser les éléments correspondants Usa las piezas que correspondan Verwende die passenden Teile Usa le parti corrispondenti 適合するパーツを使用 使用匹配部件 | <ul style="list-style-type: none"> Assembly sequence Séquence d'Assemblage Secuencia de montaje Baureihenfolge Sequenza di assemblaggio 組み立て手順 拼装顺序 | <ul style="list-style-type: none"> Stage complete Étape terminée Paso completado Schritt abgeschlossen Fase completa このステージの完成 完成 |





CHOOSE THE UNIT YOU WANT TO BUILD | CHOISISSEZ L'UNITÉ À ASSEMBLER | ESCOGE LA UNIDAD QUE QUIERES MONTAR | WÄHLE DIE EINHEIT, DIE DU BAUEN MÖCHTEST
 SCEGLI L'UNITÀ CHE VUOI ASSEMBLARE | 組み立てたいユニットを選択 | 选择您想拼装的单位

KNIGHT ABOMINANT

Chevalier Abominable • Caballero Abominante • Grauensritter
 Cavaliere Abominant • ナイト・アボミナント • 憎悪騎士

STEPS | ÉTAPES | PASOS

SCHRITTE | FASI | ステップ | 步骤

1 - 7



KNIGHT DESECRATOR

Chevalier Profanateur • Caballero Execrador • Schandritter
 Cavaliere Desecrator • ナイト・ディセクレイター • 渎神者騎士

STEPS | ÉTAPES | PASOS

SCHRITTE | FASI | ステップ | 步骤

8 - 18



KNIGHT RAMPAGER

Chevalier Saccageur • Caballero Machacador • Grimritter
 Cavaliere Rampager • ナイト・ランベイジャー • 蹂躞者騎士

STEPS | ÉTAPES | PASOS

SCHRITTE | FASI | ステップ | 步骤

8 - 18



1 a

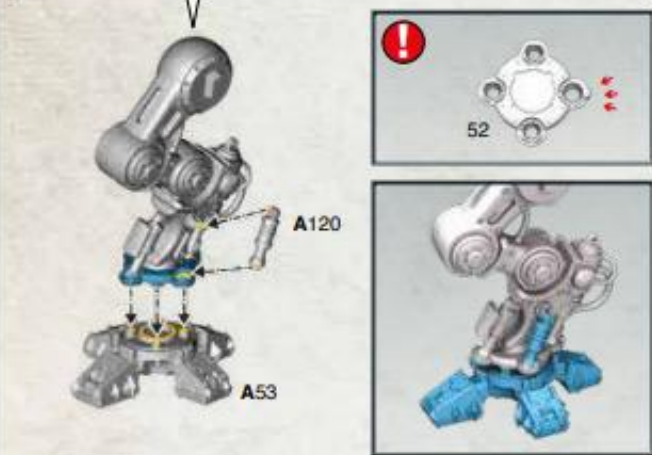
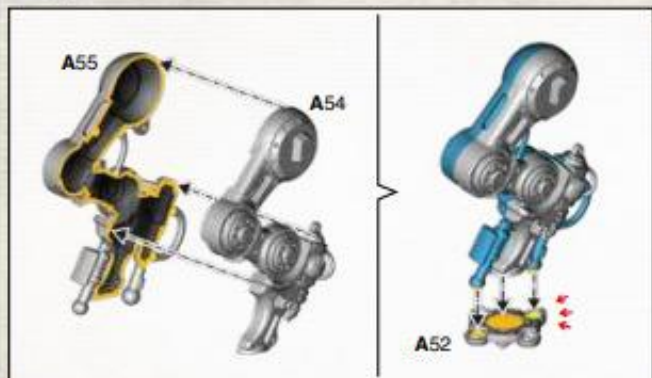

2 a

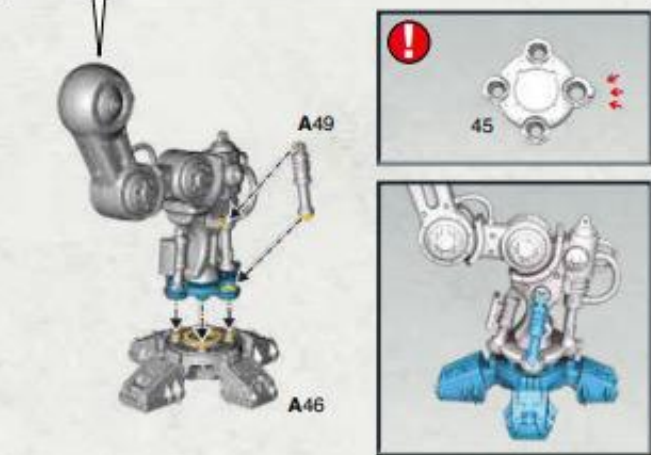
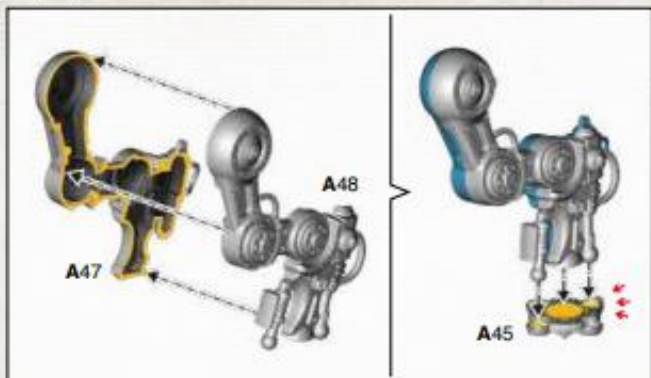

1 b



2 b

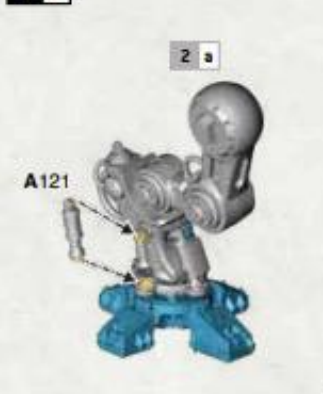

3 a

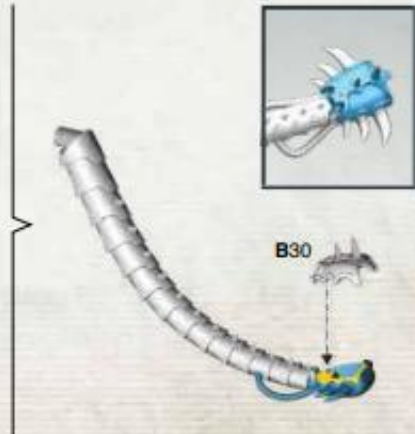
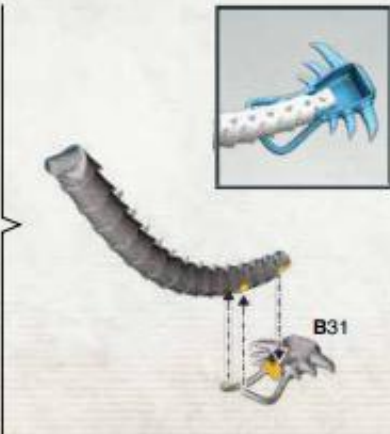
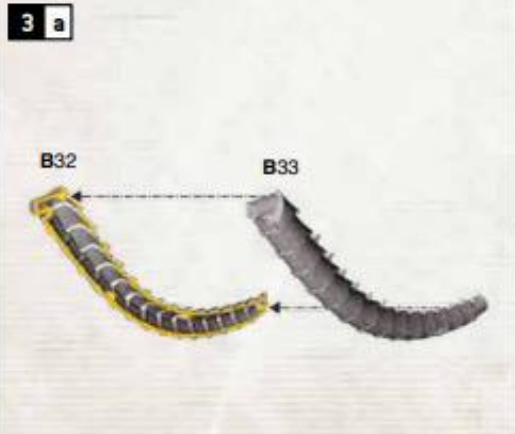

3 b

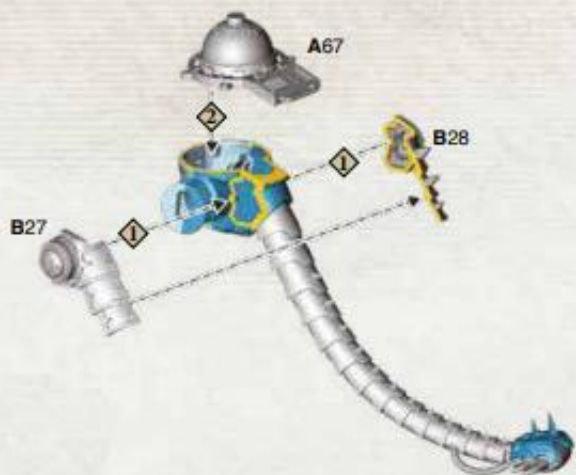
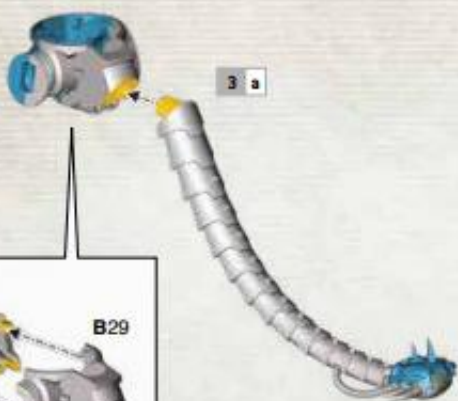

3 c

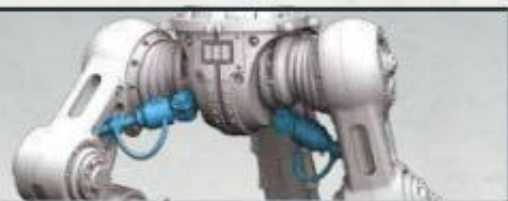
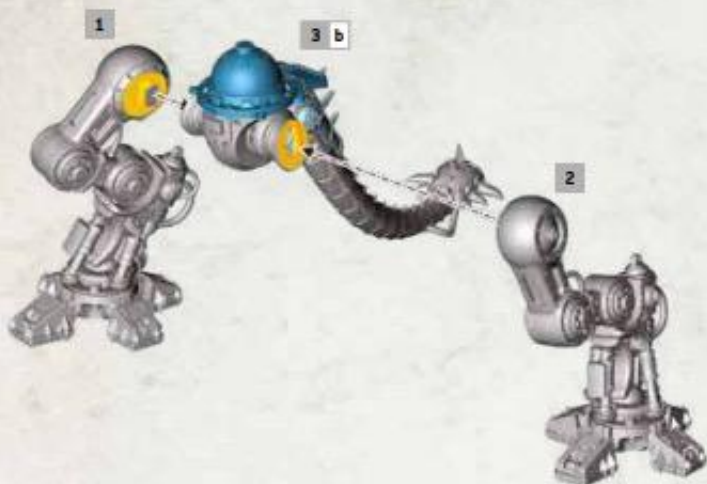

3 d

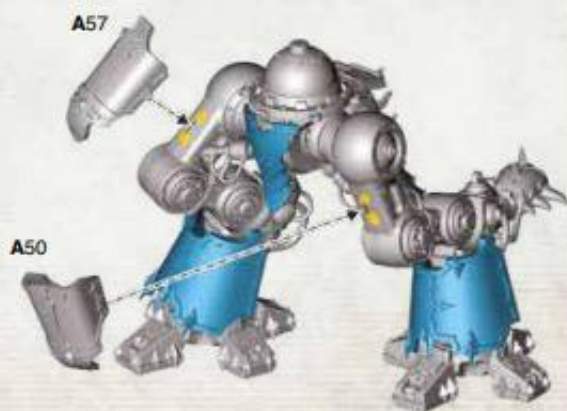
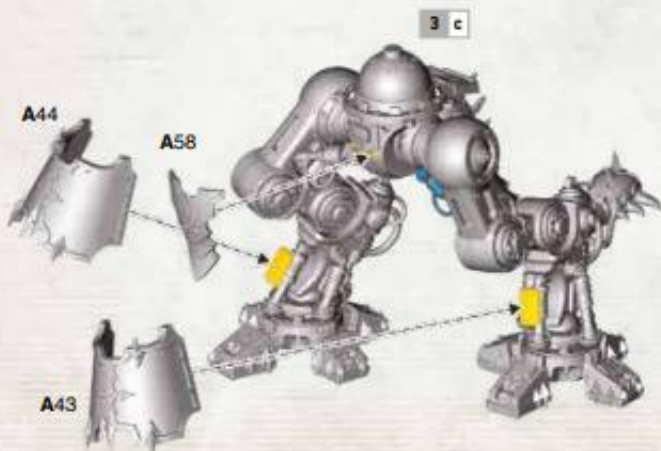

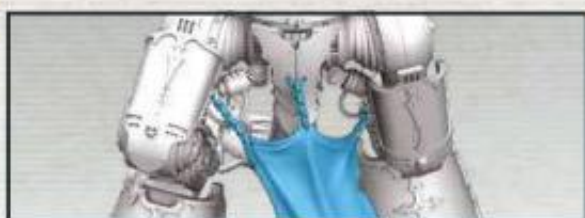
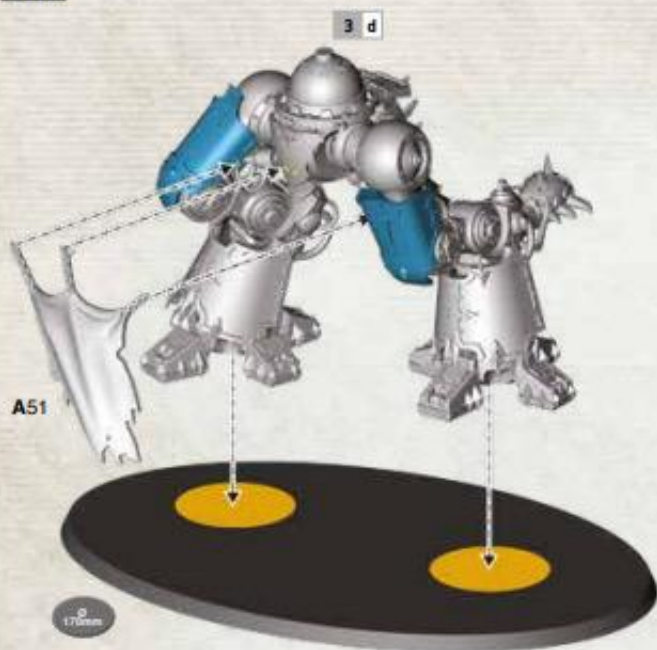
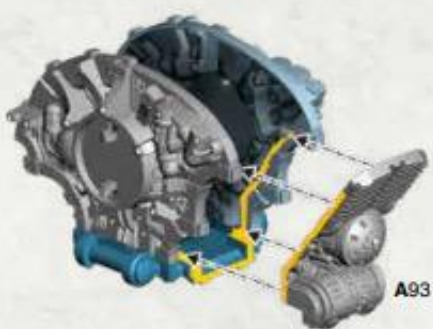
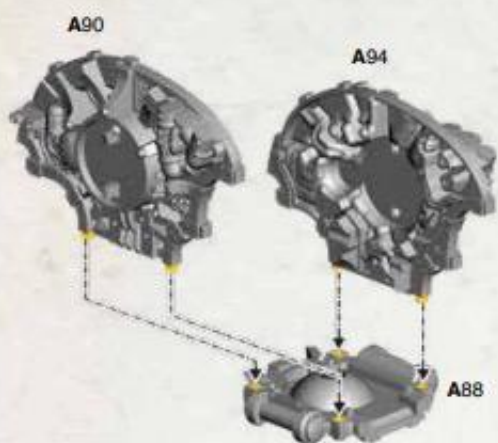
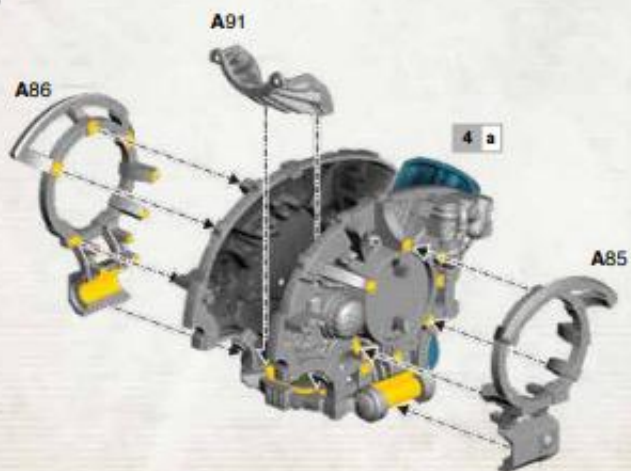
3 e**4 a****4 b**

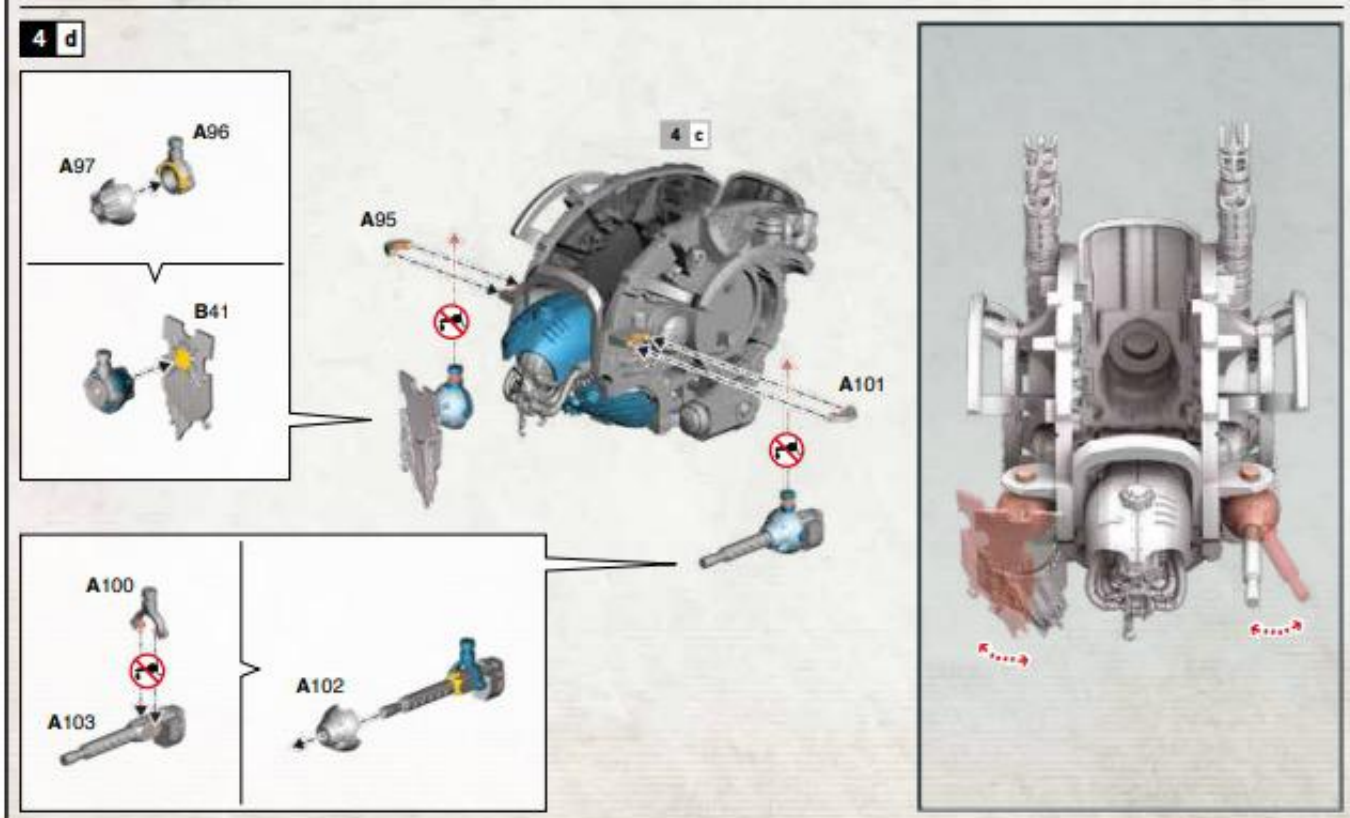
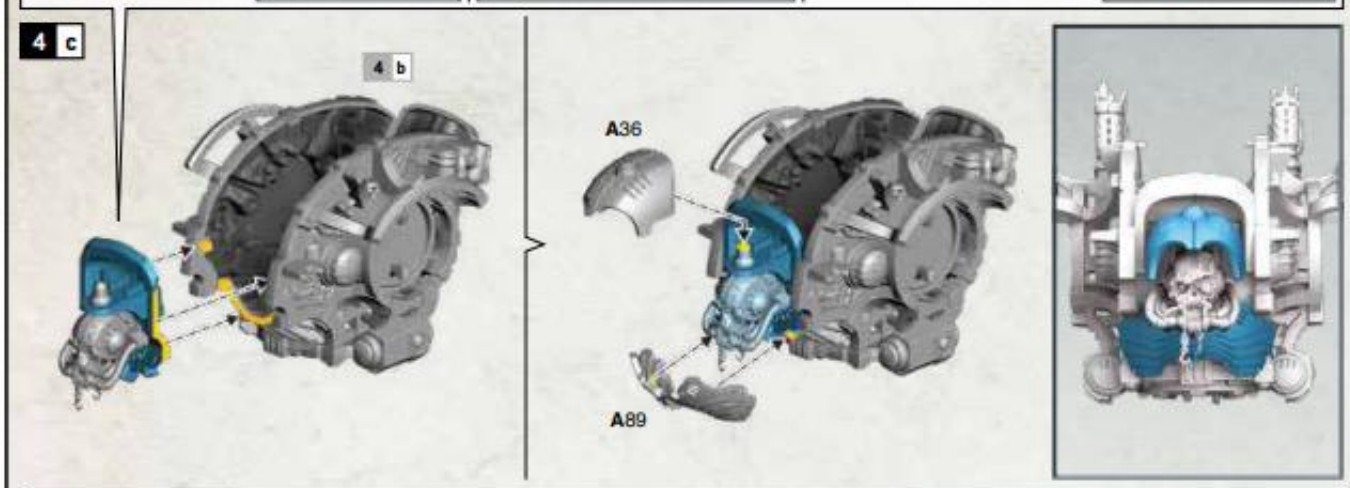
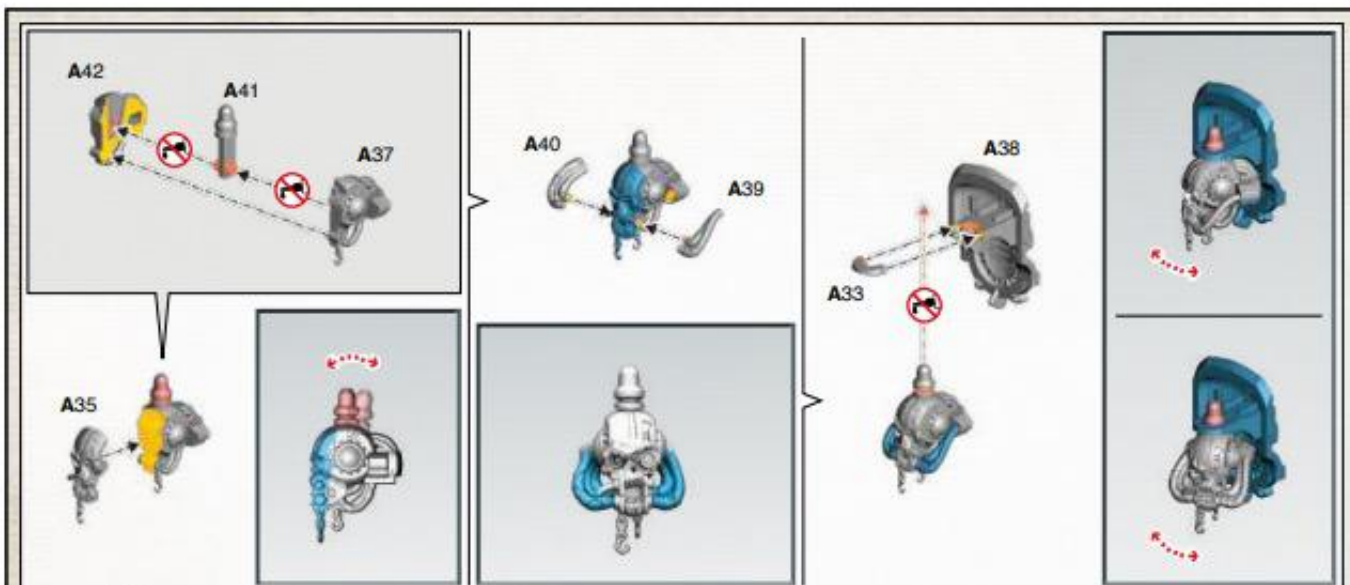

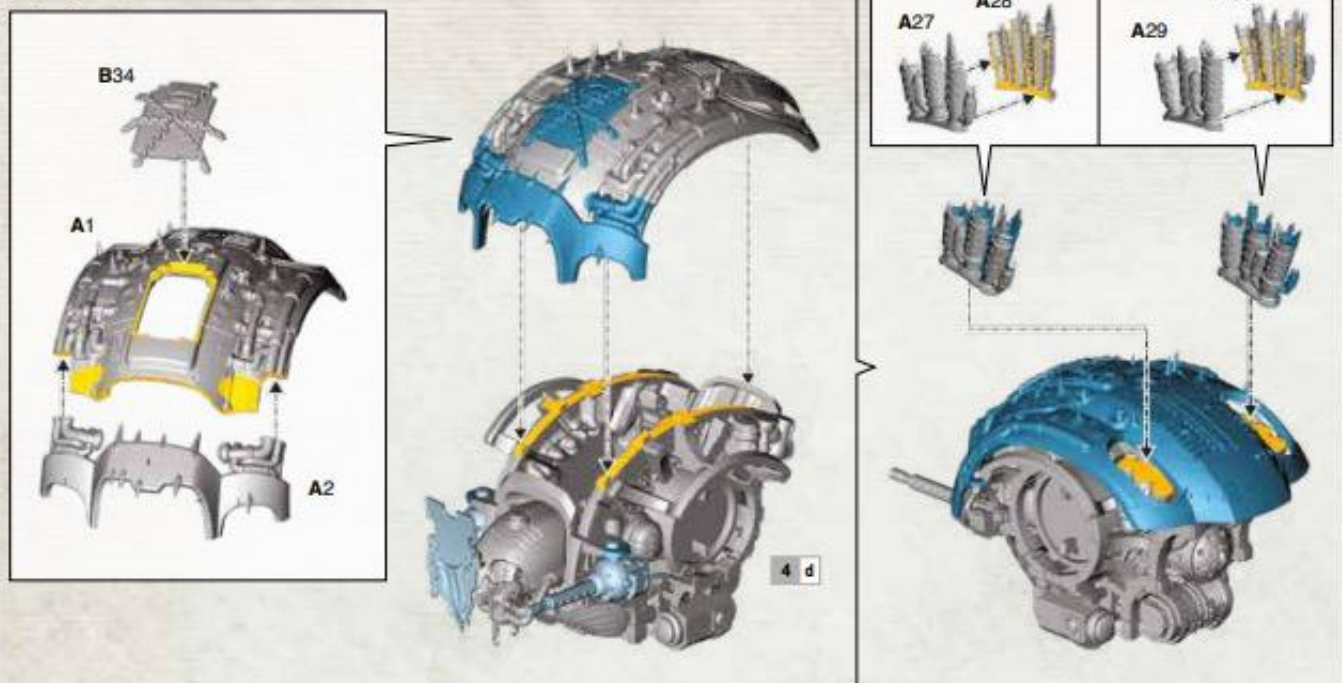
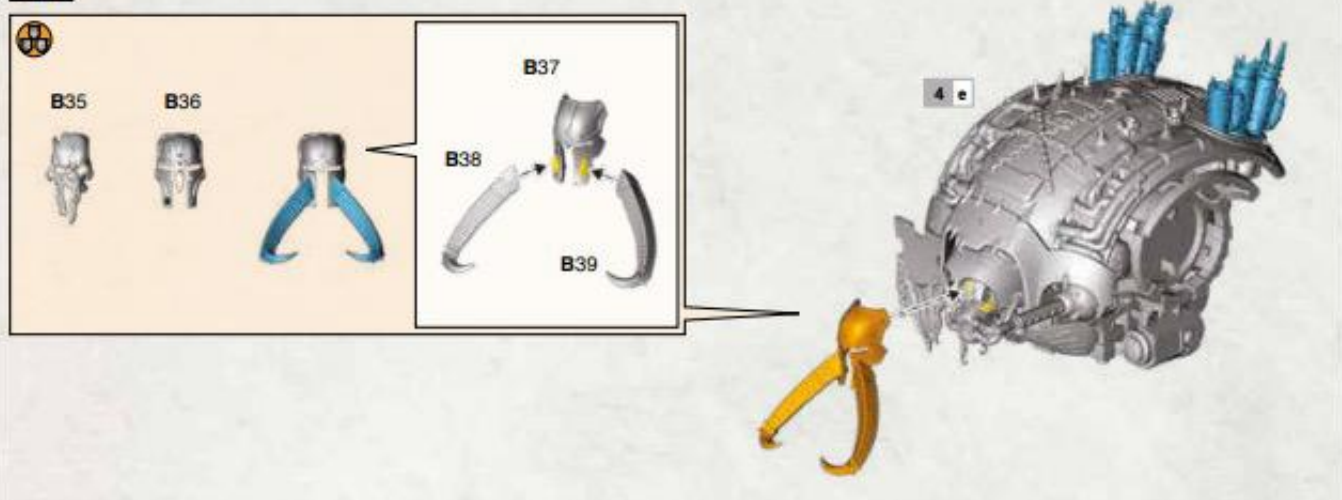
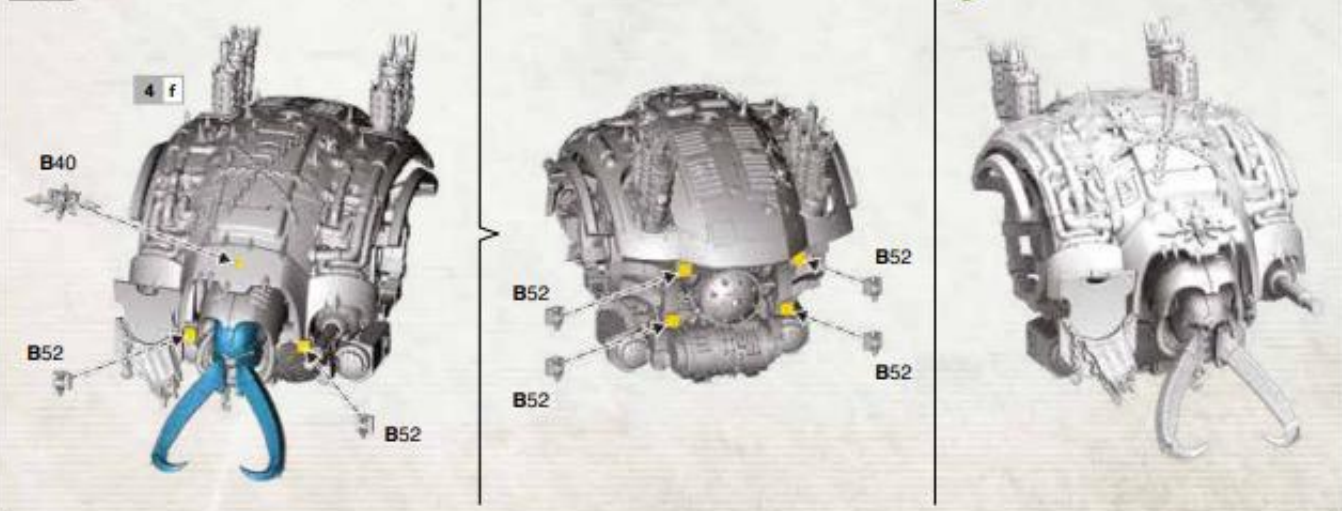
4 e**4 f****4 g**

5 a

A84 A83



B10 B12

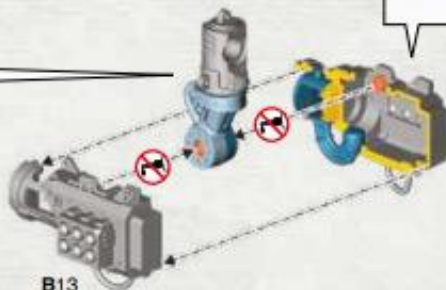
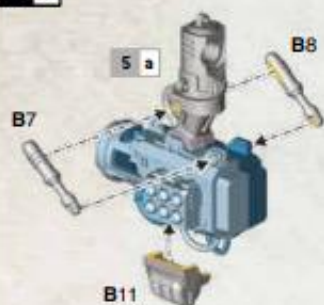
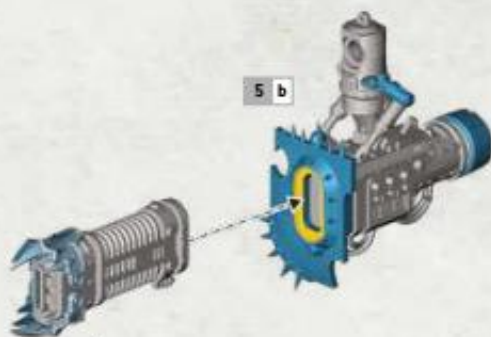

B13

**5 b****5 c**

B16

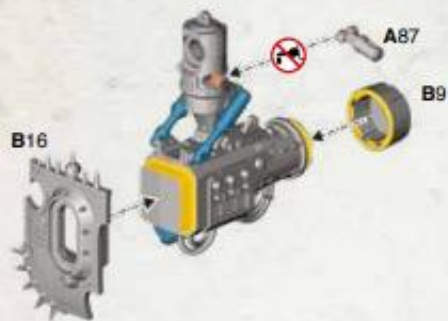

B15

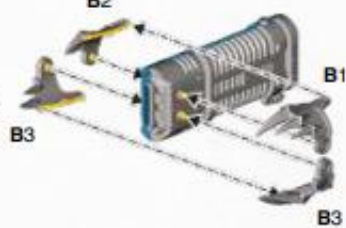
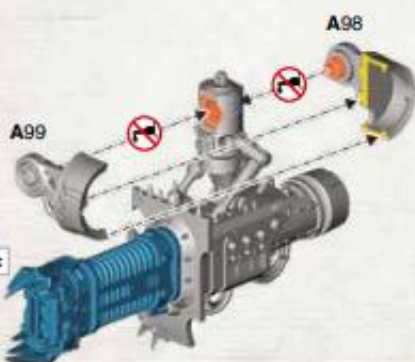

B2

**5 d**

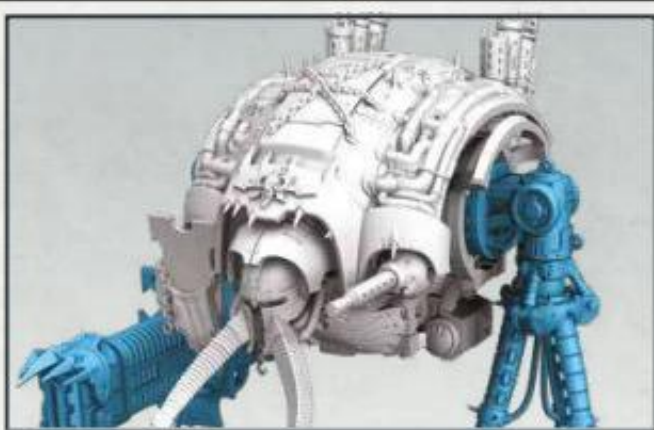
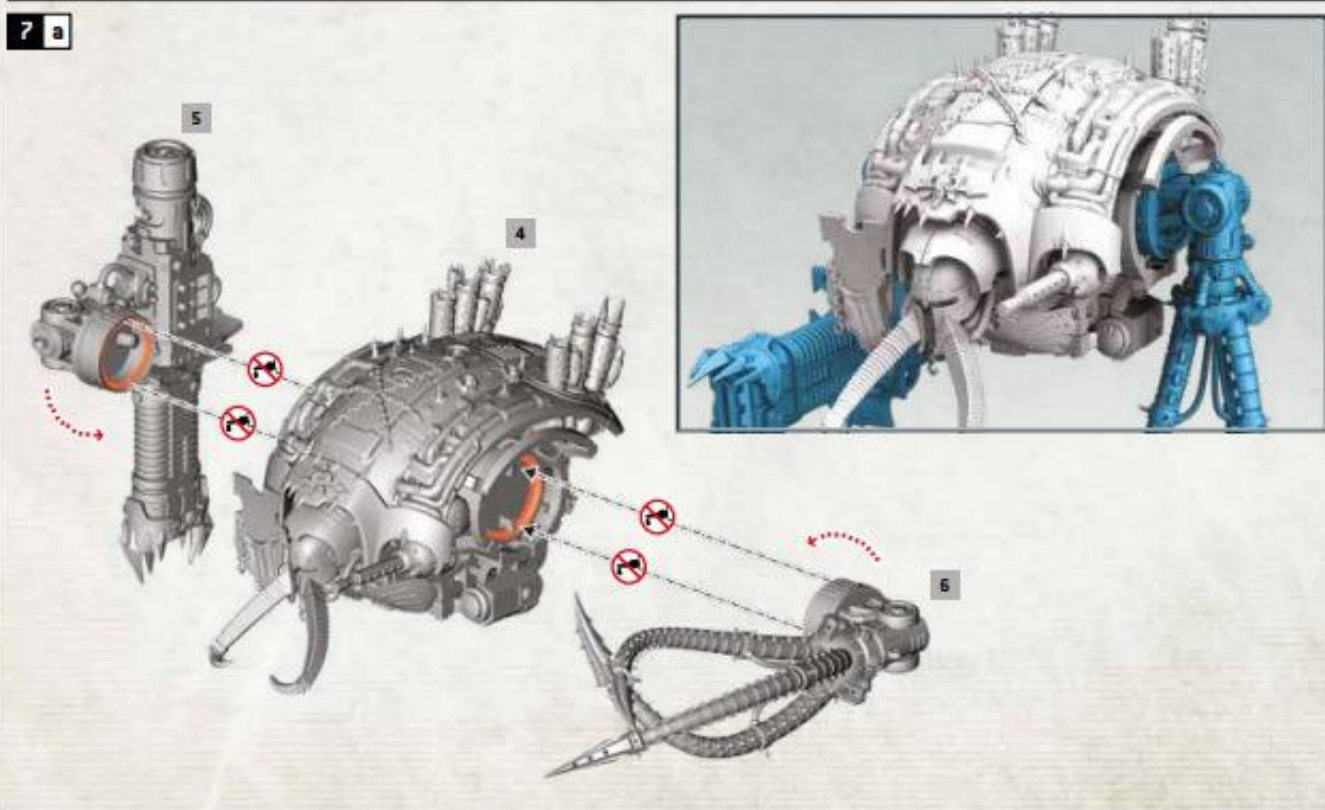
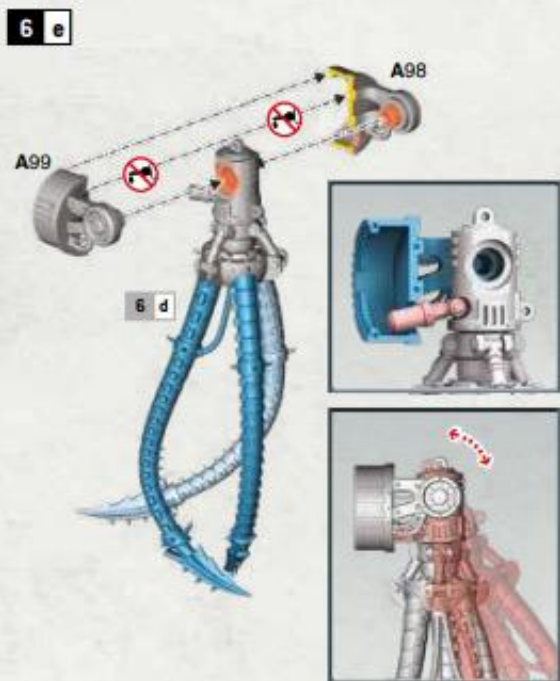
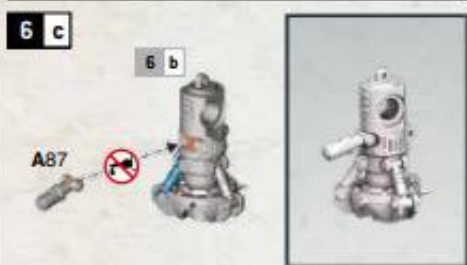
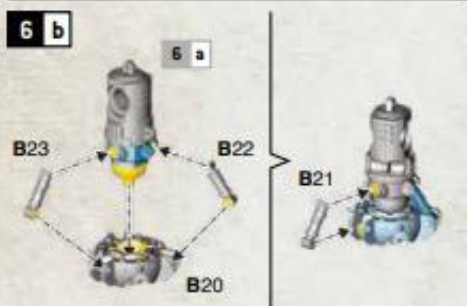
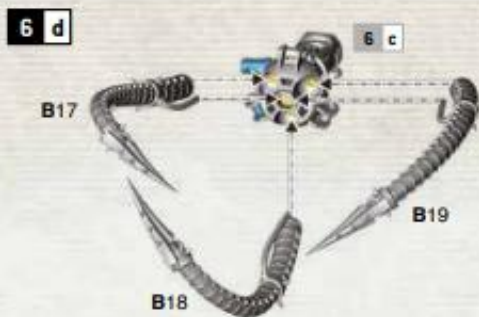
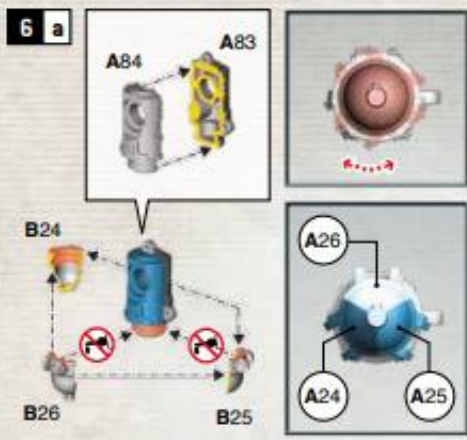

7 b

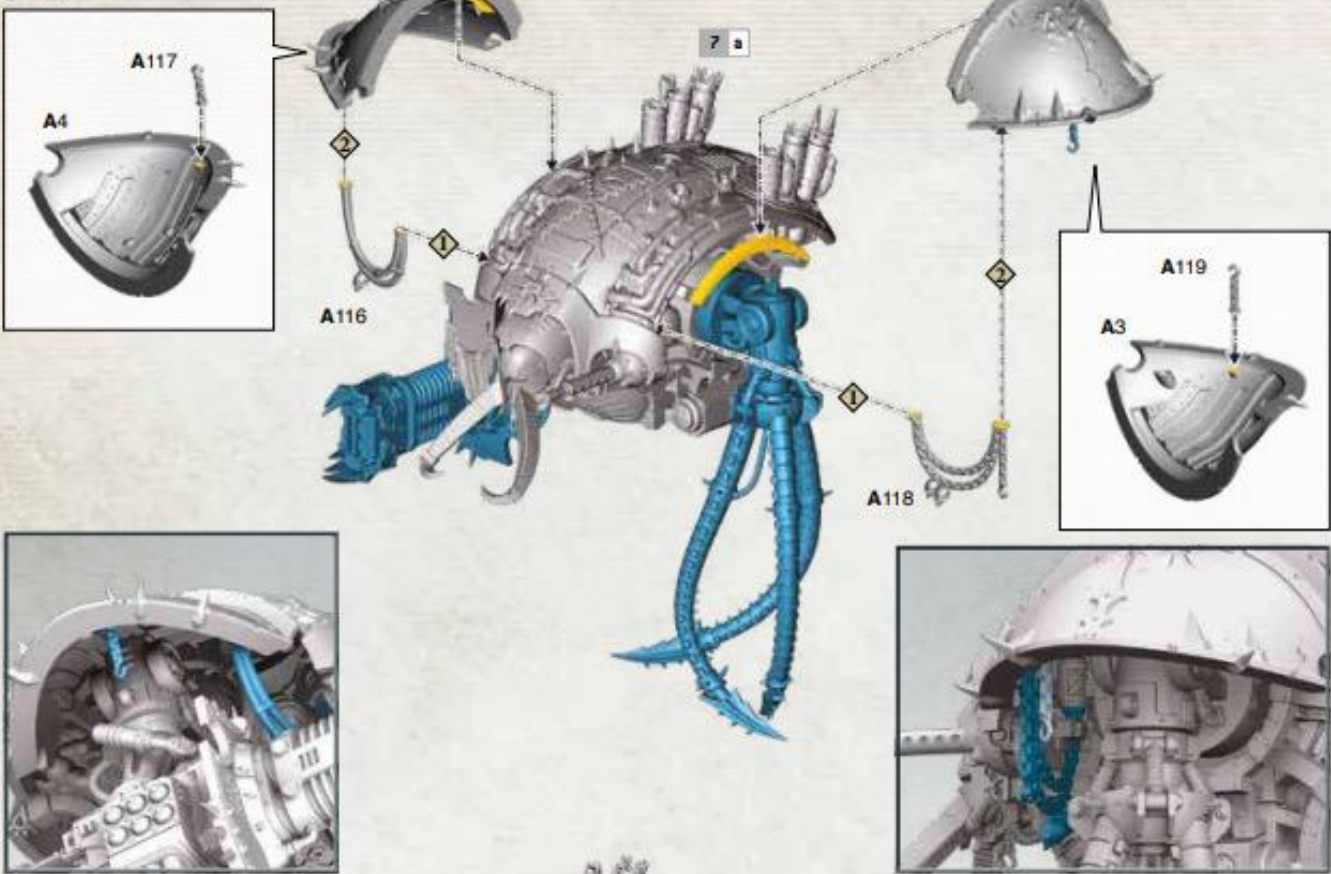

7 c



7 d

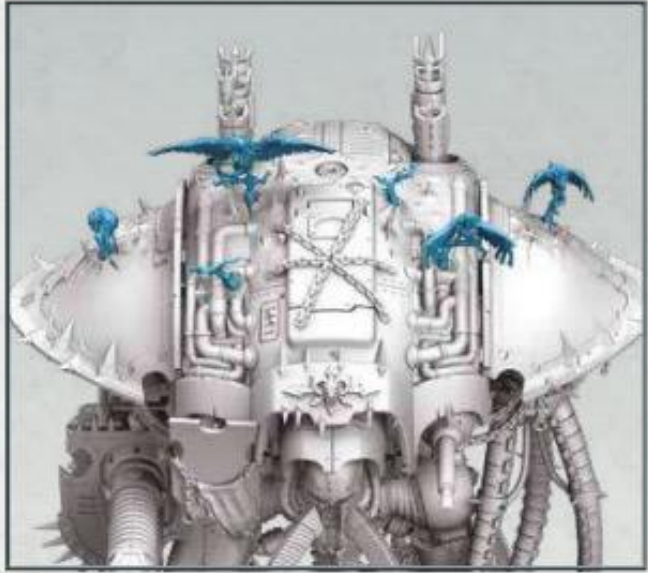
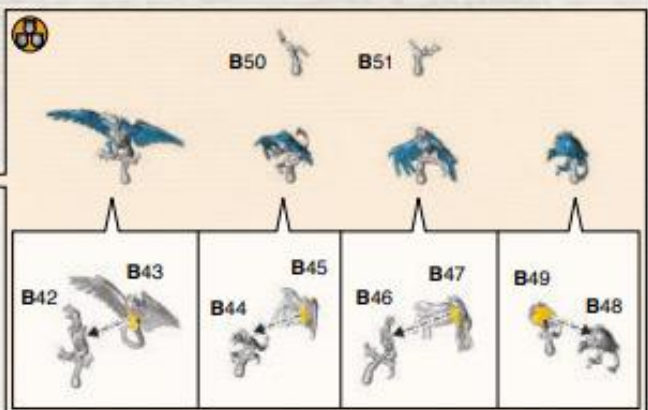

7 e



8 a

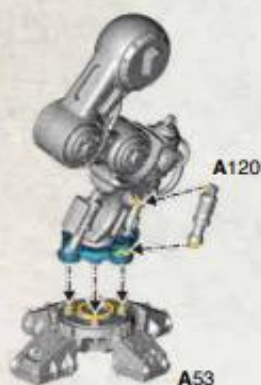
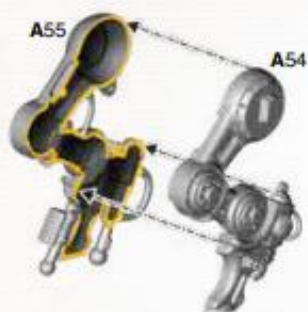

8 b



9 a

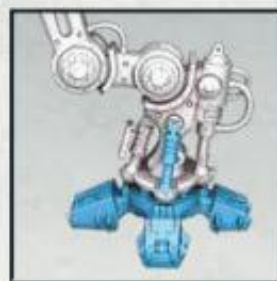
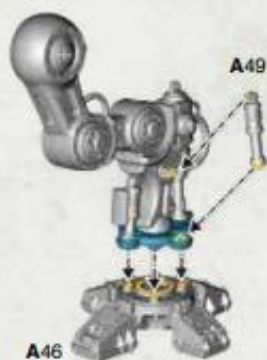
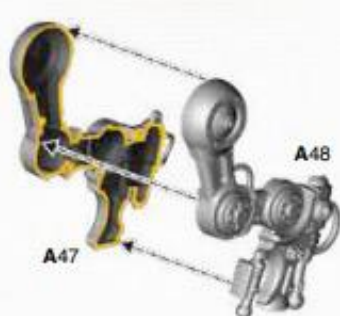

9 b

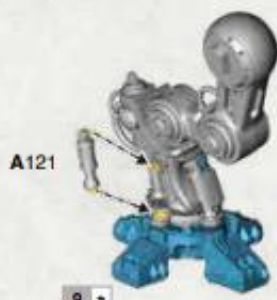

10 a

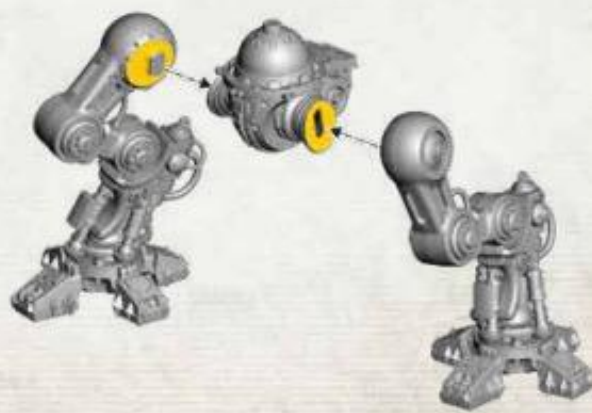
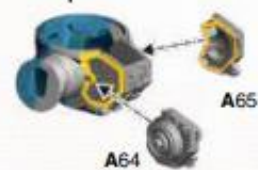

10 b**10 a**

A61

A62



A59

A60

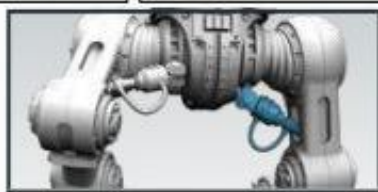
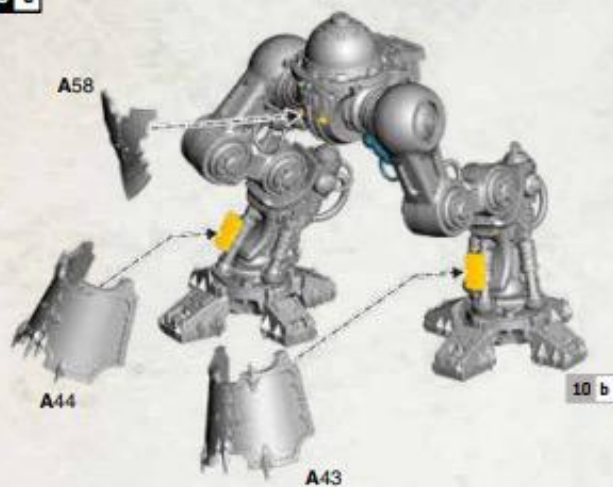
**10 c**

A58

A44

A43

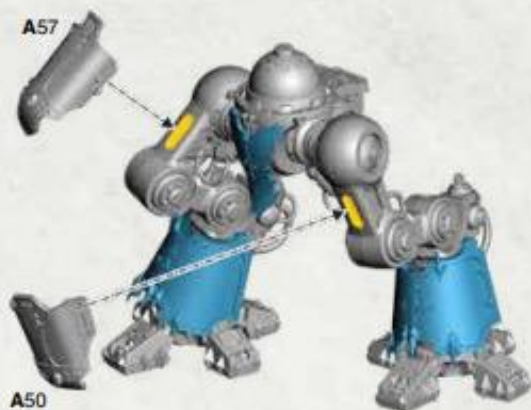
10 b

A57

A50

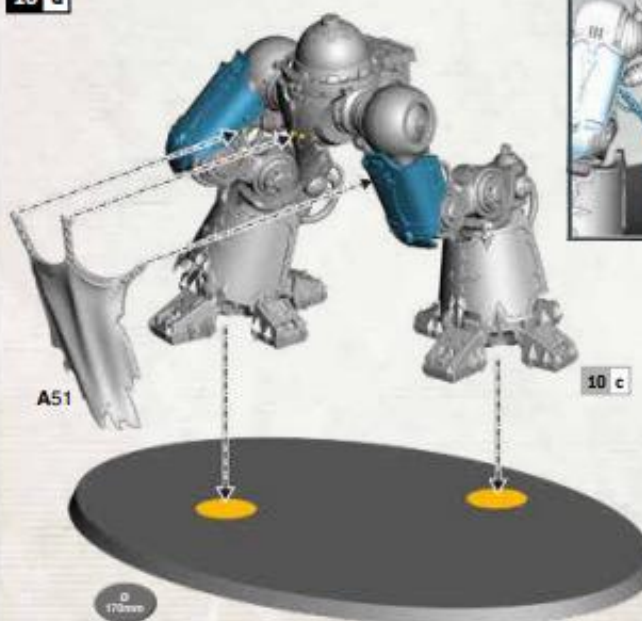
10 d

A51

10 c

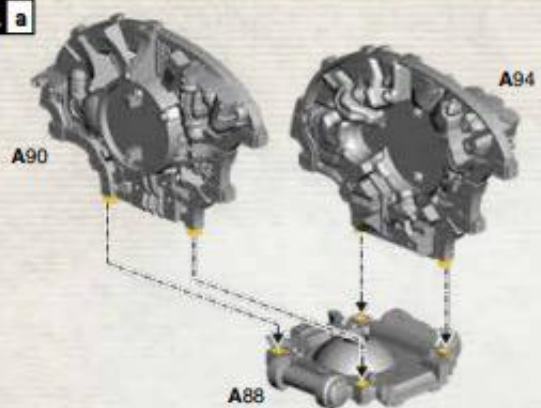
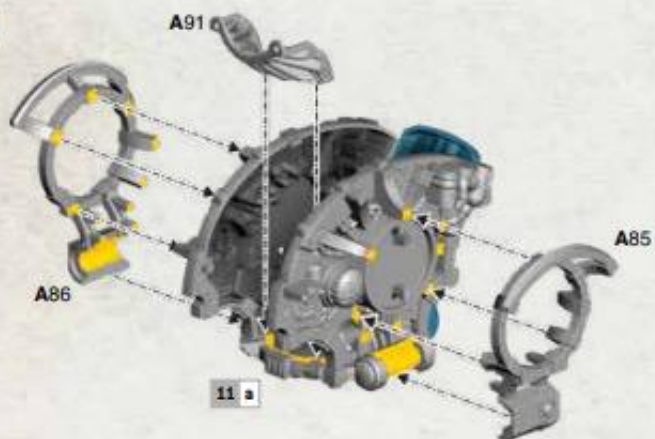
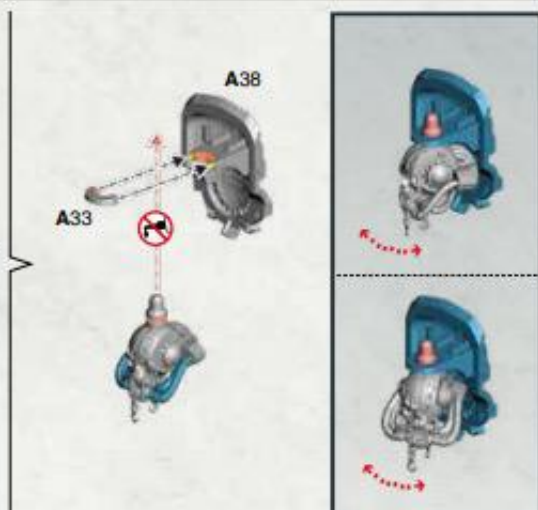
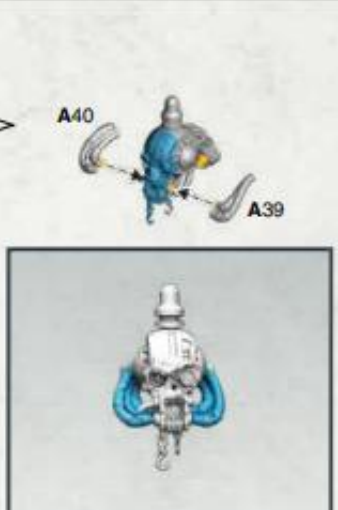
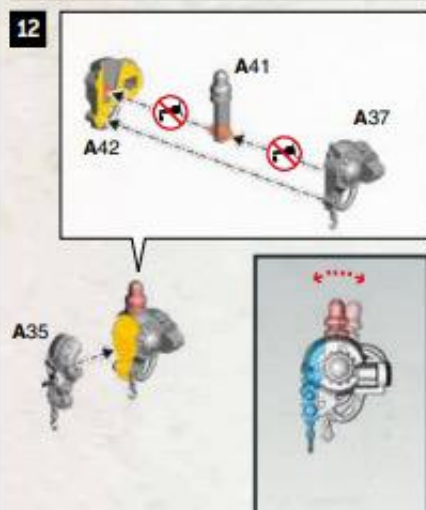
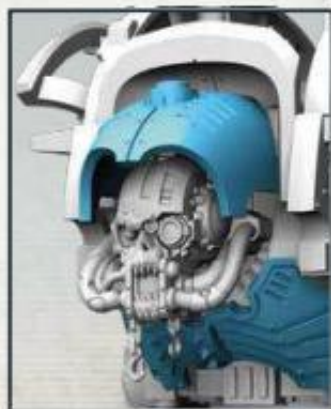
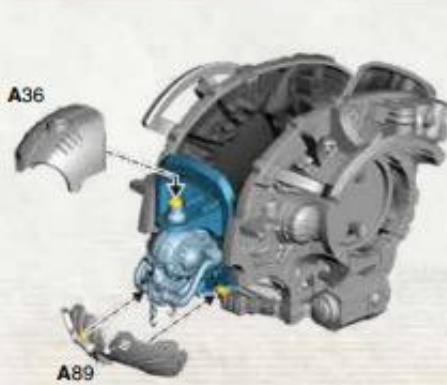
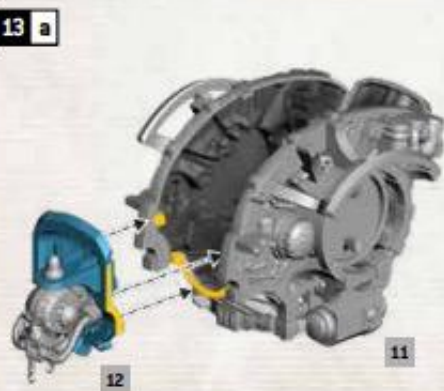
11 a**11 b****12****13 a**

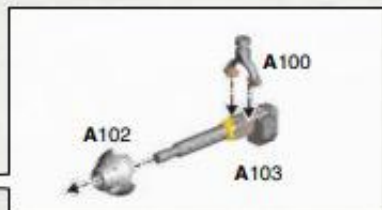
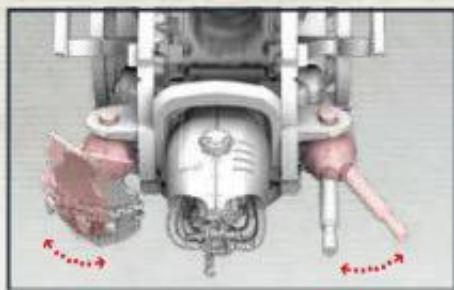
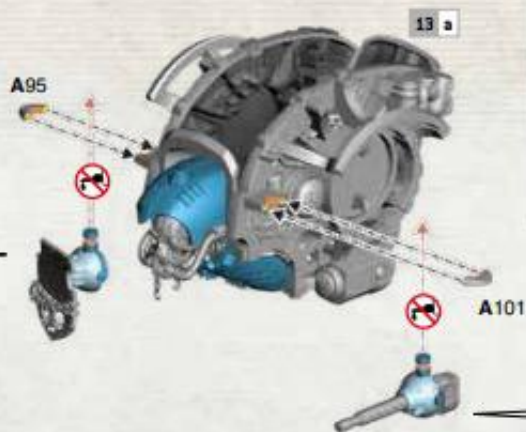
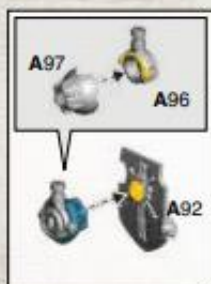
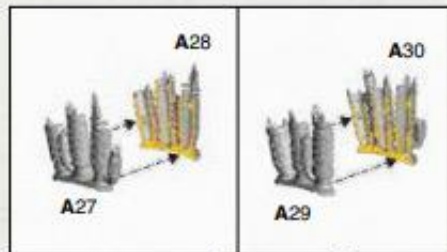
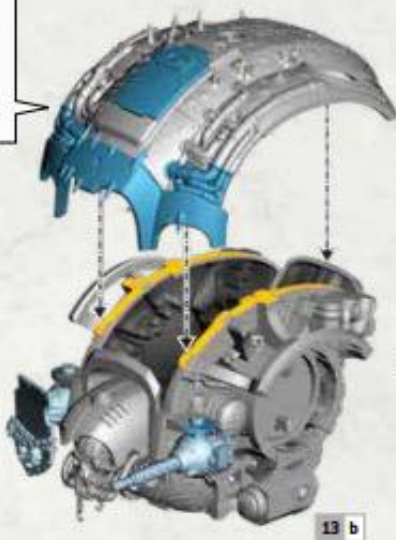
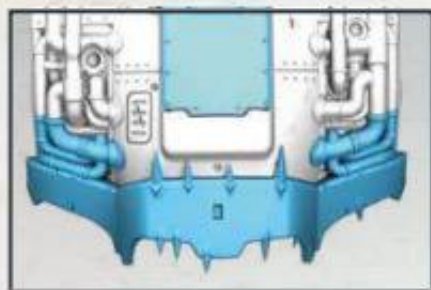
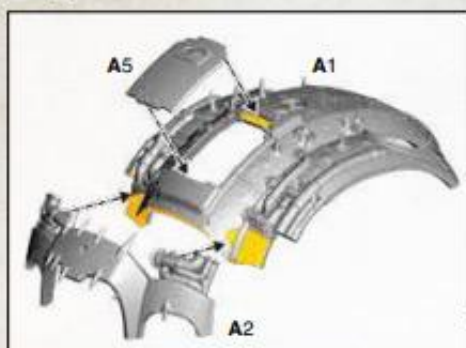
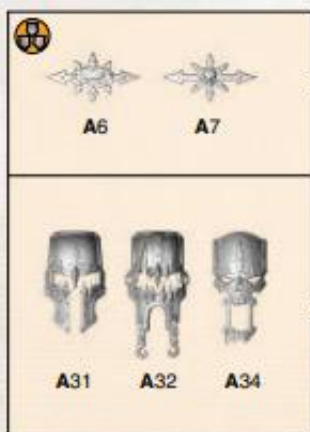
13 b**13 c****13 d**



- Choose the variant you want to build
- Choisissez la variante à assembler
- Elige qué versión quieres montar
- Wähle die Variante, die du bauen möchtest
- Scegli la variante che vuoi assemblare
- Выберите тот вариант, который хотите собрать
- 組み立てバリエーションの選択
- 选择你喜欢的拼装方式



• Knight Desecrator • Chevalier Profanateur • Caballero Execrador • Schandritzer
• Cavaliere Desecrator • ナイト・ディセクレイター • 没神者騎士



• Knight Rampager • Chevalier Saccageur • Caballero Machacador • Grimmitzer • Cavaliere Rampager
• ナイト・ランペイジャー • 蹂躞者騎士

14



15



16



14 a



14 b

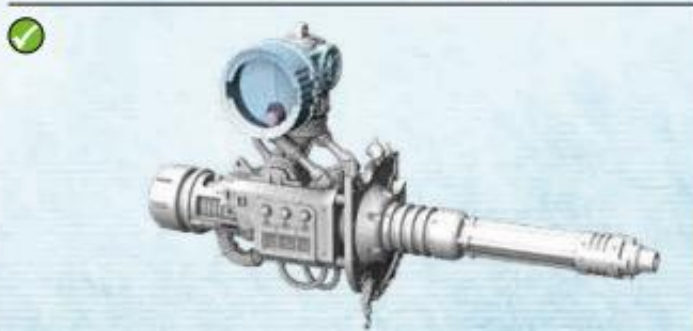
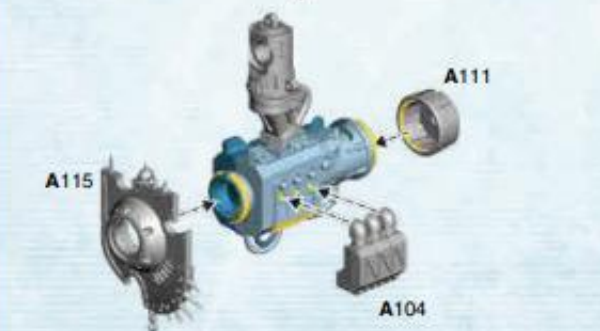
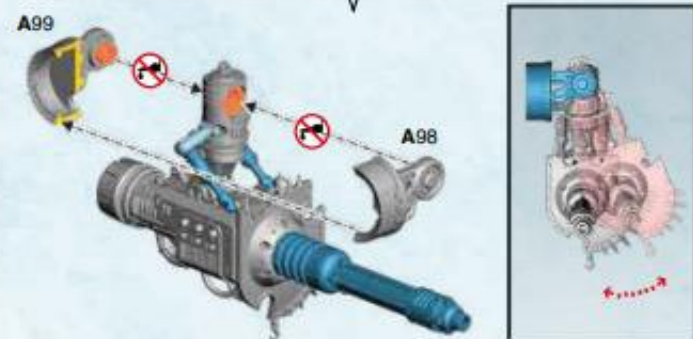
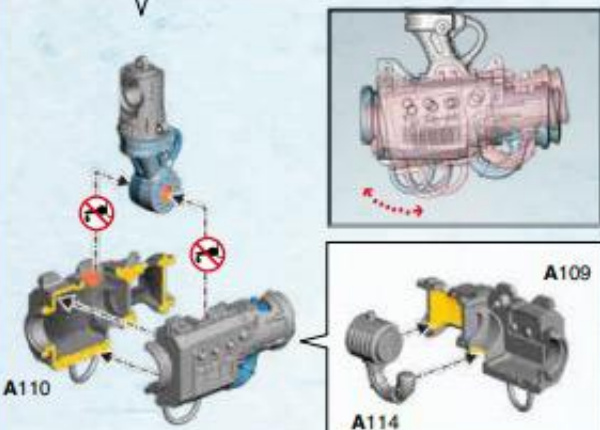
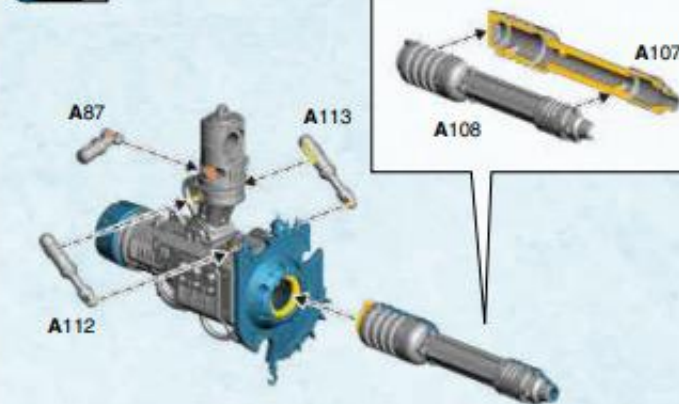

15 a



A82

A81

A83

A84

16 a

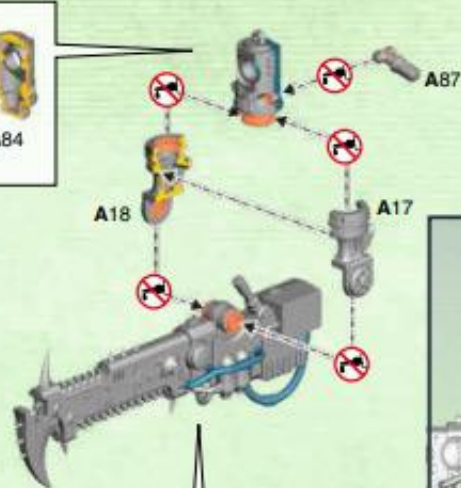

A18

A17

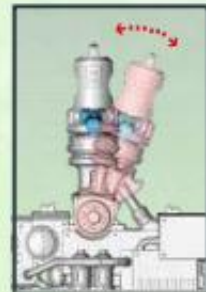

A73

A74

A76

A75

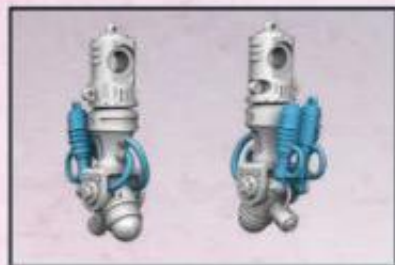

A22

A21

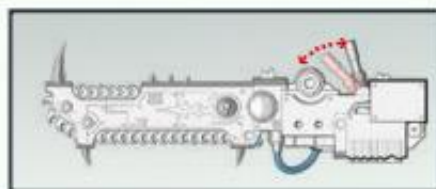

A87



A20

A19

A26



A68

A72

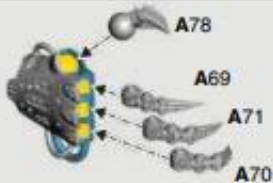

A78

A69

A71

A70



A77



15 b

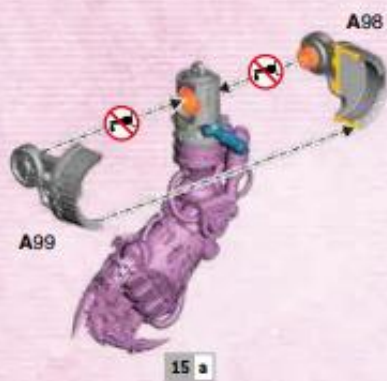

16 b



!

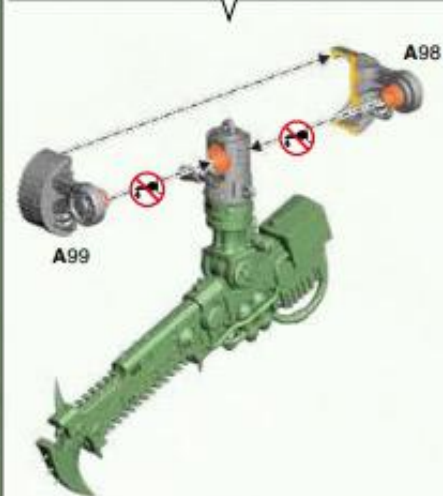

17 a

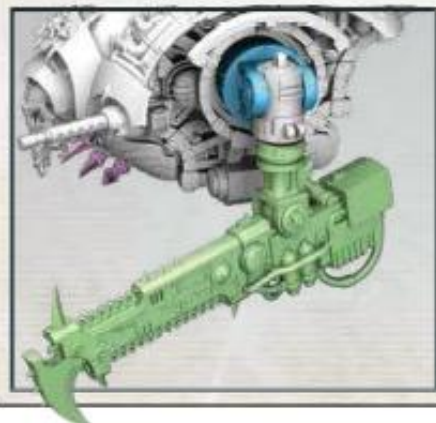
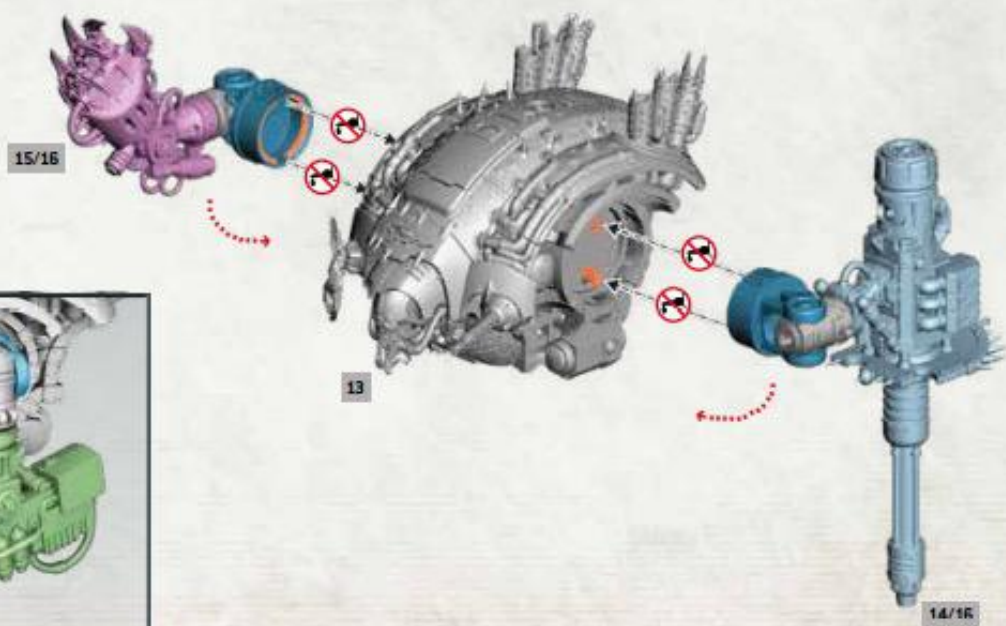

14/16

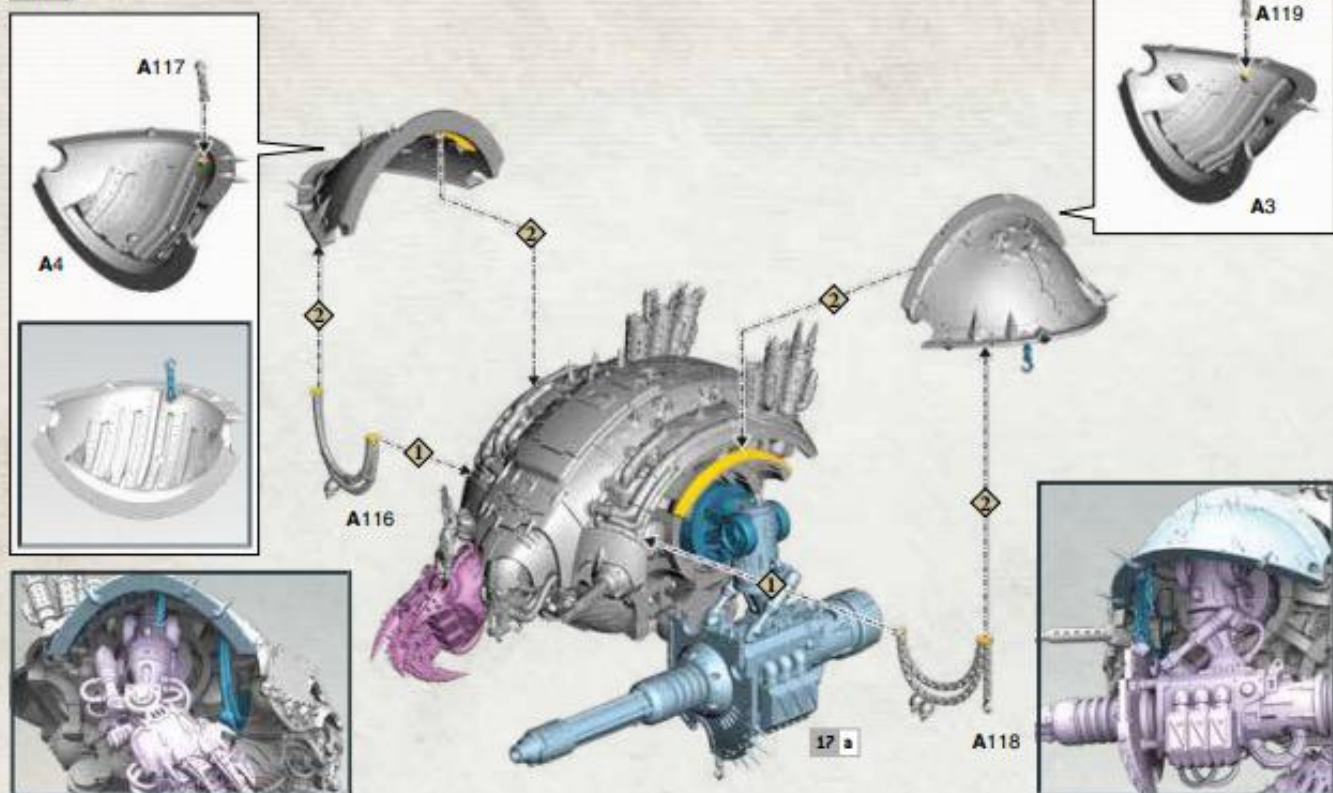
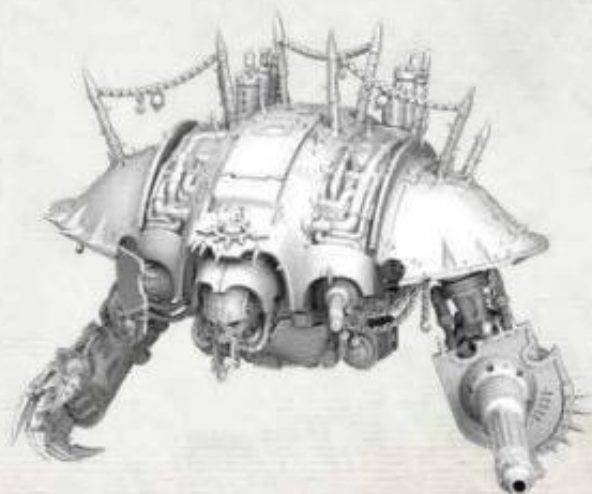
17 b**17 c****A15****A16****A10****A11****A12****A13****17 b**

18





 **A8 x4**

 **A9 x4**

 **A14**

17

10





ENG More painting guides can be found on citadelcolour.com
FRS D'autres guides de peinture sont disponibles sur citadelcolour.com
SPA Encontrará más guías de pintura en citadelcolour.com
GER Weitere Bemalungsleitungen auf citadelcolour.com

ITA Puoi trovare altre guide alla pittura su citadelcolour.com
CSD citadelcolour.comには他にも様々なペイントガイドが掲載されて
いる
CHN 更多涂装指南请在 citadelcolour.com

