



Free Downloads of Build Instructions,  
Assembly Booklets & How To Guides

**BuildInstructions.com**

# WARHAMMER THE HORUS HERESY

## CERASTUS KNIGHT LANCER

READ THIS FIRST | À LIRE EN PRIORITÉ | BITTE BEACHTE | LEE ESTO PRIMERO  
LEGGI PRIMA QUESTO | 最初にお読みください。 | 请优先阅读

**ENG** BEFORE ASSEMBLING YOUR MINIATURES, PLEASE READ THROUGH THE INSTRUCTIONS IN THIS BOOKLET CAREFULLY.

A pair of plastic cutters is required to remove the plastic components in this kit from their frame. We advise using a mouldline scraping tool to clean up the parts. To assemble your model you will need plastic glue. Games Workshop sells Citadel Fine Detail Cutters, Citadel Mouldline Removers and Citadel Plastic Glue, but does not recommend these products for use by children under the age of 16 without adult supervision.

**FRE** AVANT D'ASSEMBLER VOS FIGURINES, VEUILLEZ LIRE ATTENTIVEMENT LES INSTRUCTIONS DE CE LIVRET. Une pince coupante est requise pour détacher chaque élément de sa grappe plastique. Nous vous recommandons l'utilisation d'un ébarboir pour gratter chaque élément. Pour l'assemblage, vous aurez besoin de colle plastique. Games Workshop commercialise les Pinces de Précision Citadel, l'Ébarboir Citadel et la Colle Plastique Citadel, mais n'en recommande pas l'utilisation aux enfants de moins de 16 ans sans la supervision d'un adulte.

**SPA** POR FAVOR, LEE CUIDADOSAMENTE ESTE LIBRETO DE INSTRUCCIONES ANTES DE EMPEZAR A MONTAR LAS MINIATURAS.

Te harán falta unas tenazas para plástico a fin de separar las piezas de la matriz. También aconsejamos una herramienta para quitar rebabas a fin de limpiar cada pieza. Para montar la miniatura necesitarás pegamento para plástico. Games Workshop vende Tenazas de detalle superfino, Quitarrebabas Citadel y Pegamento para plástico Citadel, pero no recomienda estos productos a menores de 16 años sin la supervisión de un adulto.

**GER** VOR DEM ZUSAMMENBAU DER MINIATUREN BITTE DIE ANWEISUNGEN IN DIESER ANLEITUNG AUFMERKSAM DURCHLESEN.

Du benötigst einen Kunststoffseitenschneider, um die Kunststoffbauteile aus dem Gussrahmen herauszutrennen. Außerdem empfehlen wir, die Bauteile mit einem Gussgratentferner zu säubern. Um dein Modell zusammenzubauen, benötigst du Kunststoffkleber. Games Workshop bietet Präzisions-Seitenschneider und Gussgratentferner von Citadel sowie Citadel-Kunststoffkleber an, empfiehlt aber, dass Kinder unter 16 Jahren diese nur unter Aufsicht eines Erwachsenen benutzen.

**ITA** PRIMA DI ASSEMBLARE LE TUE MINIATURE LEGGI ATTENTAMENTE TUTTE LE ISTRUZIONI DI QUESTO LIBRETTO. Sono necessarie un paio di tronchesine per plastica per staccare i componenti dai loro sprue. Consigliamo di usare un attrezzo apposito per pulire i componenti. Per assemblare il modello avrai bisogno di colla per plastica. Games Workshop vende Tronchesine di ultraprecisione Citadel, Attrezzo per ripulire Citadel e Colla per plastica Citadel, ma non consiglia questi prodotti ad un pubblico minore di 16 anni senza la supervisione di un adulto.

**ESN** 始める前に必ず説明書をお読みください。本キット内のフレームからプラスチックパーツを切り離すためには、ニッパーが必要です。パーツのモールドを平らにするには、専用ツールの使用をお勧めいたします。本キットの組み立てには、プラ用接着剤が必要です。ゲームズワークショップはスーパー・ファインディテール・カッター、シタデル・プラスチックグルー、シタデル・モールドラインリムーバーを販売しておりますが、16歳以下の子供が大人の監督なしにこれらの道具を使用されることをお勧めしません。

**CHN** 在组装您的微缩模型之前，请仔细阅读本手册中的说明。

您需要一把模型剪将塑料部件从板件上剪下来。我们建议使用模线刮刀来处理零件。组装时您还需要用到塑料胶水。您可以从 Games Workshop 处购买到 Citadel 精密剪钳、Citadel 模线刮刀和 Citadel 塑料胶水，但 16 岁以下儿童不得在没有成年人监护的情况下使用这些产品。

16+

Citadel Plastic Glue  
Colle plastique liquide Citadel  
Pegamento para plástico fluido  
Citadel-Kunststoffkleber  
Colla per plastica fluida Citadel  
シタデルプラスチック接着剤流し込みタイプ  
Citadel 塑料流体黏胶



Super Fine Detail Cutters  
Pince Coupante de Précision  
Tenazas de detalle superfino  
PRÄZISIONS-SEITENSCHNEIDER  
Tronchesine di ultraprecisione  
スーパー・ファインディテール・カッター  
精密剪钳



Mouldline Remover  
Ébarboir  
Quita-rebabas  
Gussgratentferner  
Attrezzo per ripulire  
モールドライン・リムーバー  
合模线刮刀

### EXPLANATION OF SYMBOLS | EXPLICATION DES SYMBOLES EXPLICACIÓN DE SÍMBOLOS | ERLÄUTERUNG DER SYMBOLE LEGENDA DEI SIMBOLI | アイコン解説 | 符号说明

- ! Assemble last  
Assembler en dernier  
Montar último  
Baue dies zuletzt zusammen  
Assembla per ultimo  
最後に組み立てよう  
最后组装

- 🔍 Detail view  
Vue détaillée  
Vista detallada  
Alternative Ansicht  
Visuale del dettaglio  
拡大  
局部放大视图

- 🚫 Do not glue the components  
Ne pas coller les éléments  
No pegar los componentes  
No pegar los componentes  
Bitte die Teile nicht kleben  
Non incollare i componenti  
このパーツは接着不可  
请勿粘接

- 🔄 Choice of parts  
Choix d'éléments  
Piezas opcionales  
Auswahl an Teilen  
Scelta di componenti  
パーツの選択  
选择部件

- ⚙️ Variant assembly  
Variante d'assemblage  
Variante de montaje  
Bauvariante  
Assemblaggio alternativo  
組み立てバリエーション  
多种组装方式

- 🔪 Shim to allow for different poses  
Couper pour permettre d'autres poses  
Cortar para crear diferentes posiciones  
Für andere Posen abtrennen  
Rimuovi per ottenere pose differenti  
ポーズを変えたい場合は切り取る  
移除部件获取不同形态

- x2 Repeat process  
Répéter l'étape  
Repetir pasos  
Vorgang wiederholen  
Ripeti il processo  
同じ作業を繰り返すこと  
重复步骤

- ✅ Stage complete  
Étape terminée  
Paso completado  
Schritt abgeschlossen  
Fase completa  
このステージの完成  
完成

- 🖌️ Paint before assembly  
Peindre avant assemblage  
Pintar antes del montaje  
Erst bemalen, dann zusammenbauen  
Dipingi prima dell'assemblaggio  
組み立て前にペイントすること  
组装前涂装



CITADEL  
MINIATURES

© Copyright 2023, Games Workshop Ltd. All rights reserved.

993 130080045



# CERASTUS KNIGHT LANCER

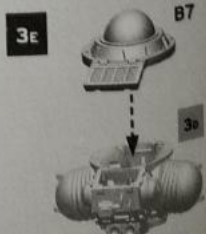
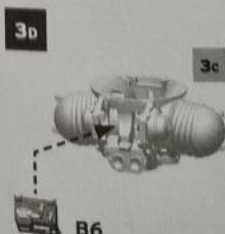
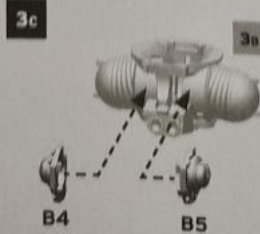
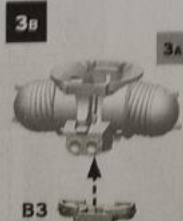
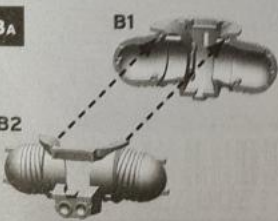
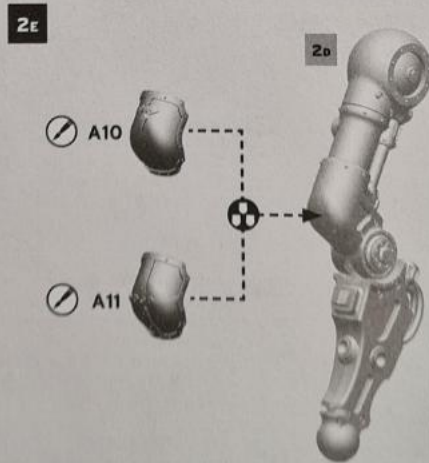
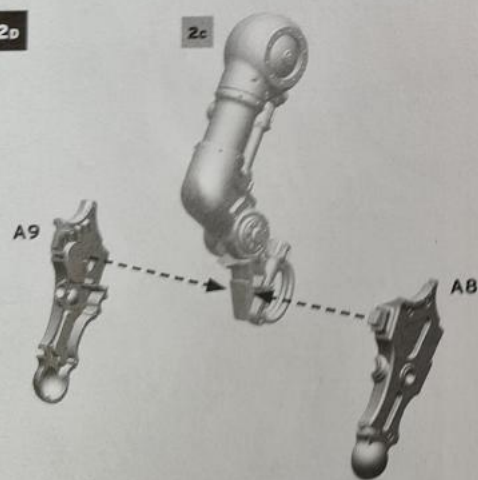
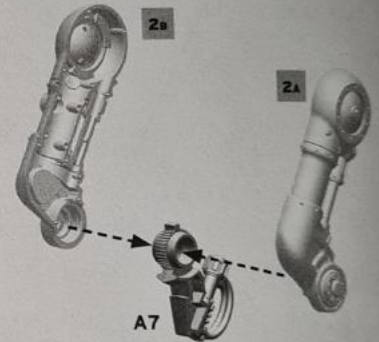
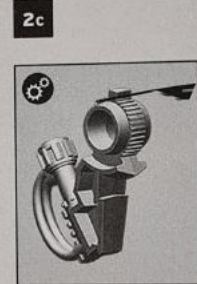
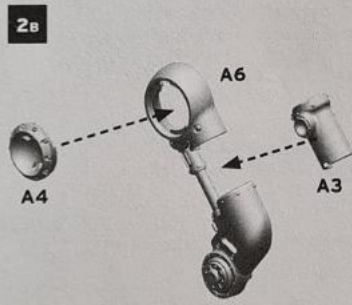
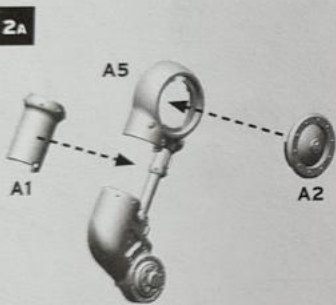
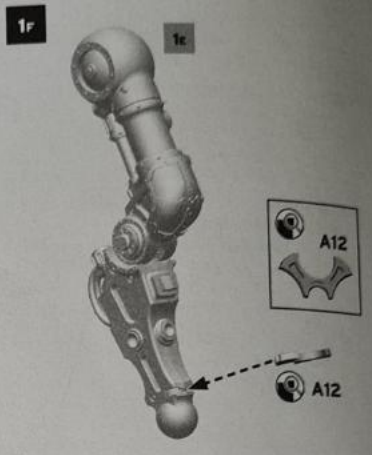
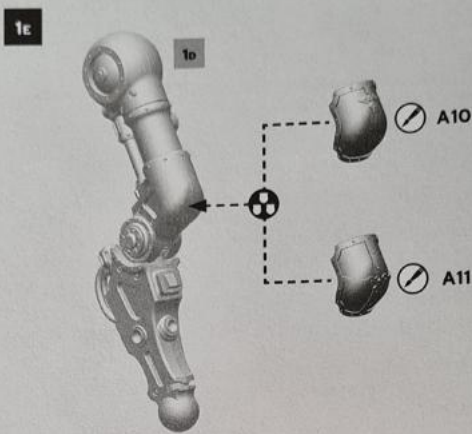
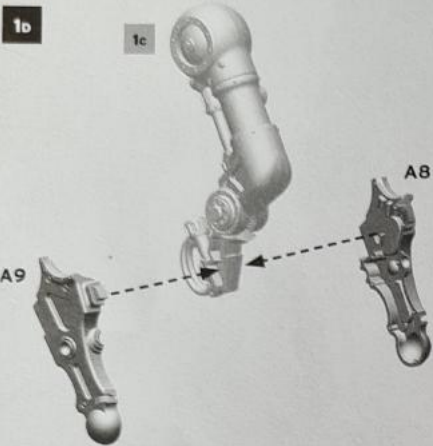
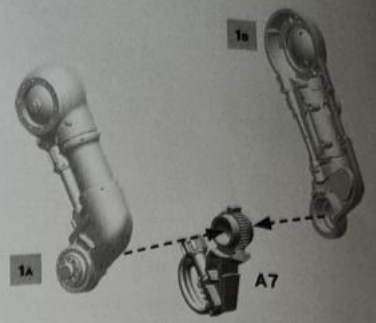
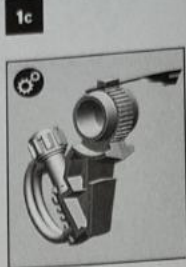
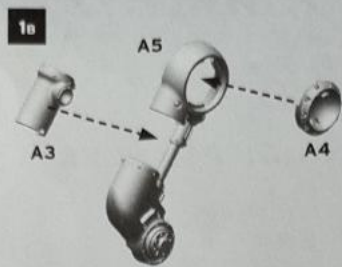
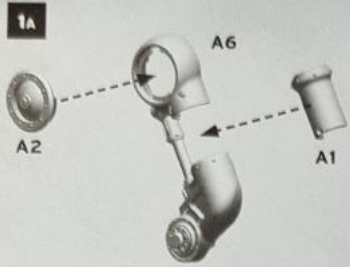

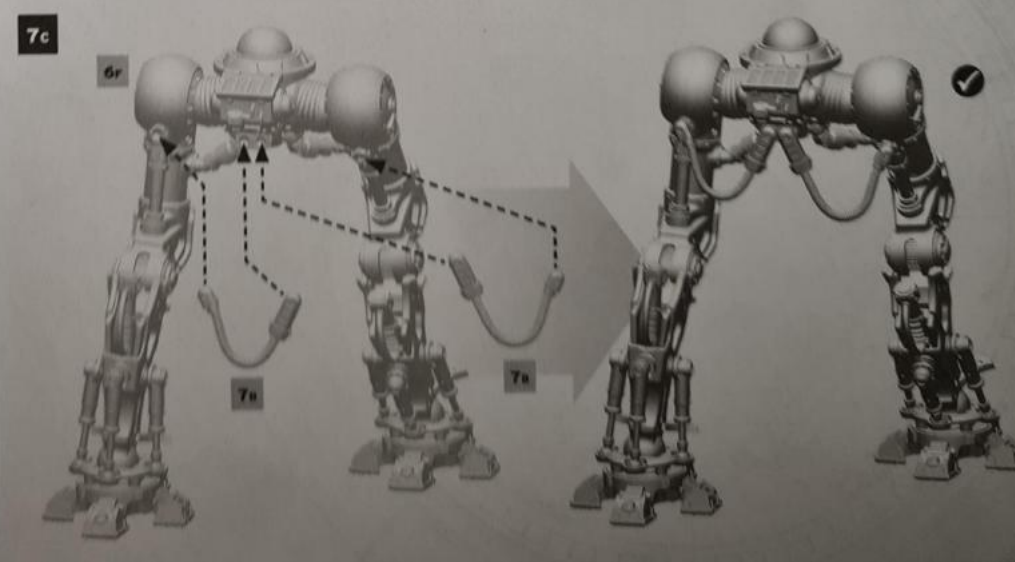
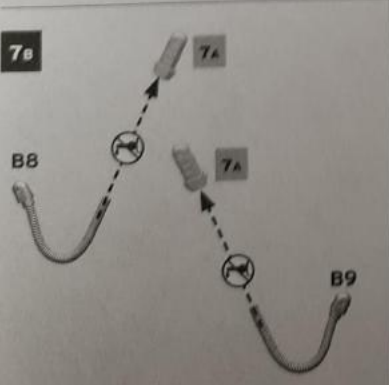
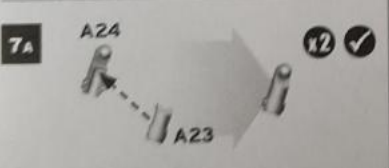
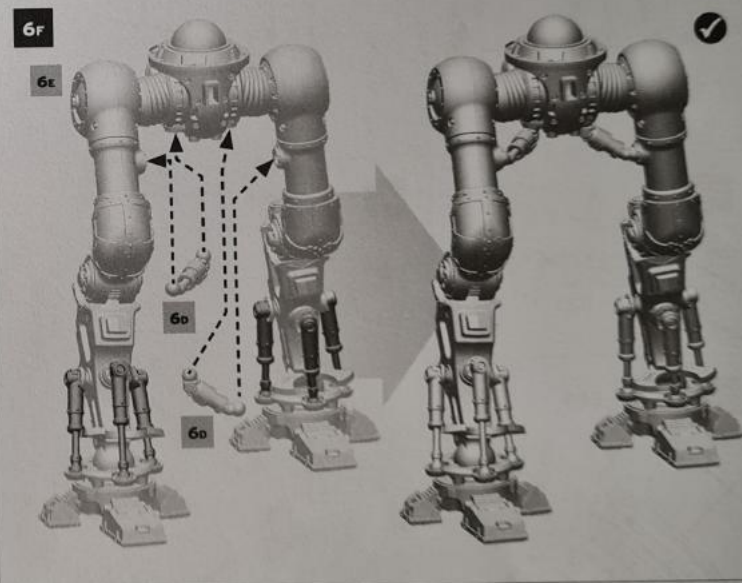
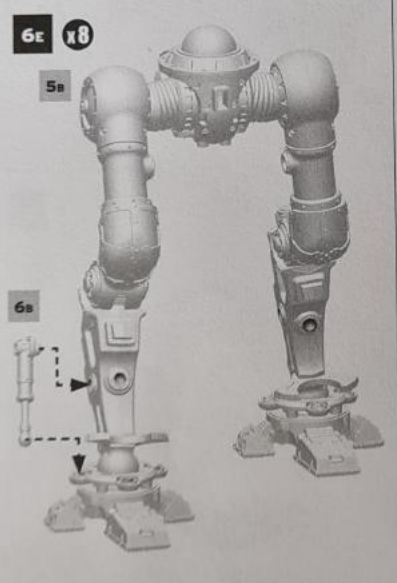
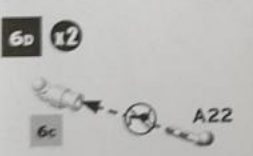
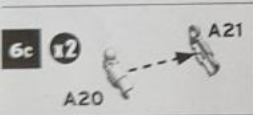
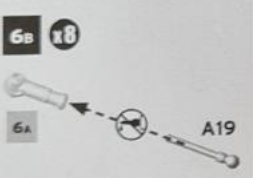
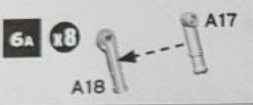
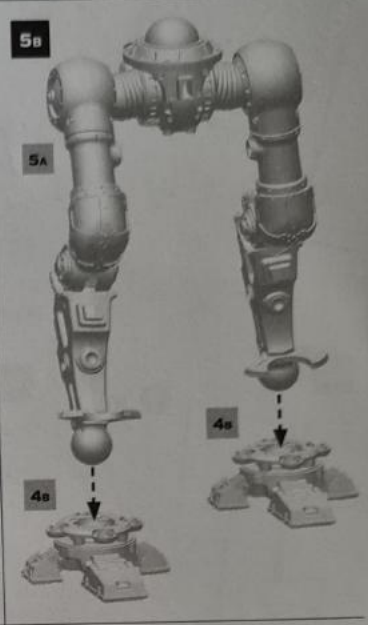
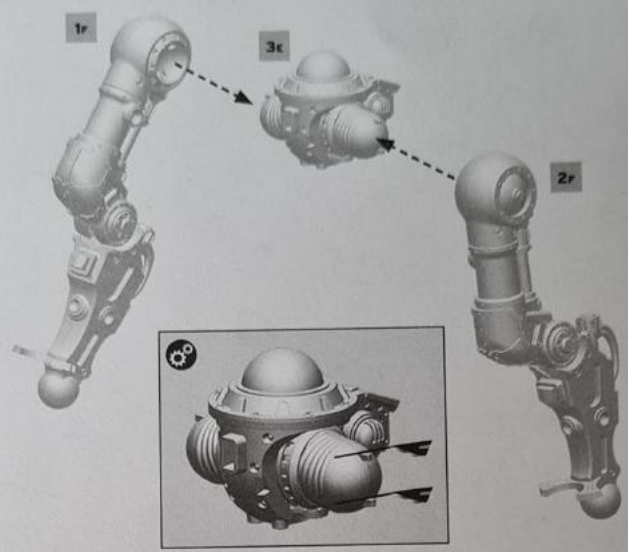
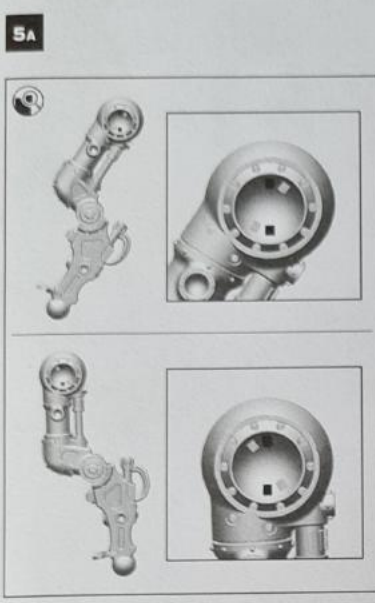
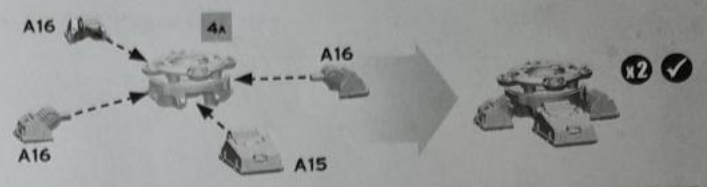
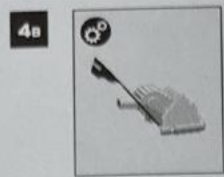
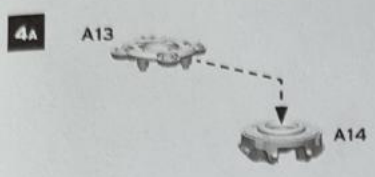



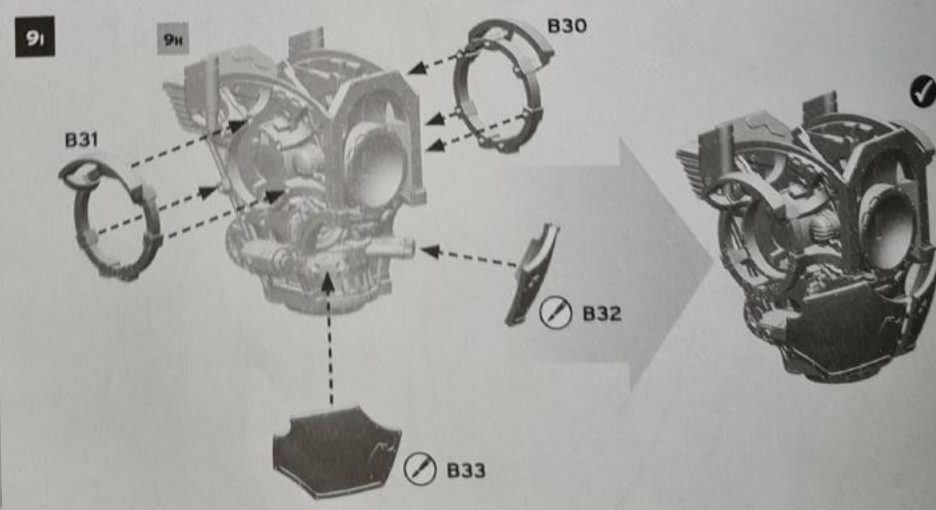
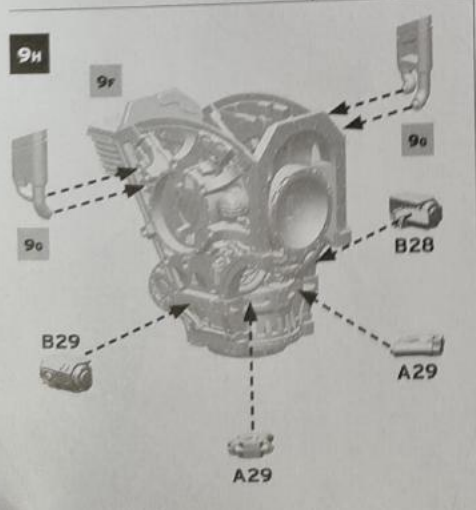
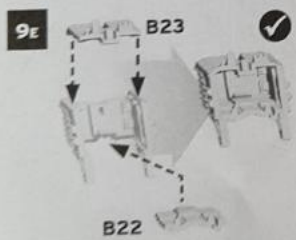
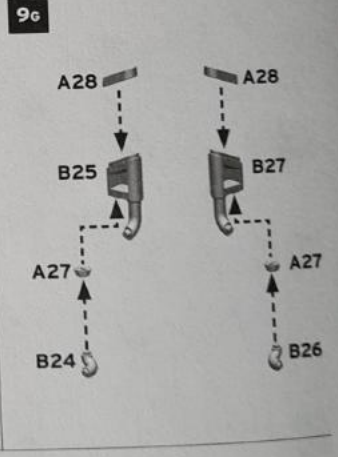
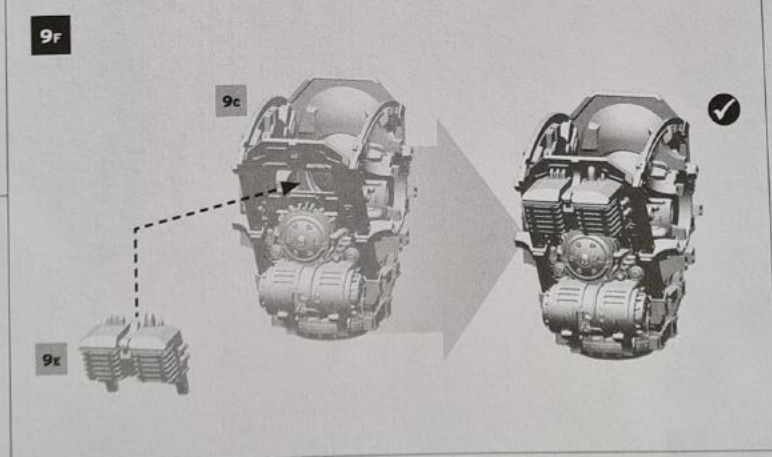
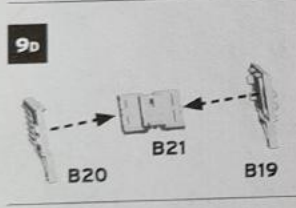
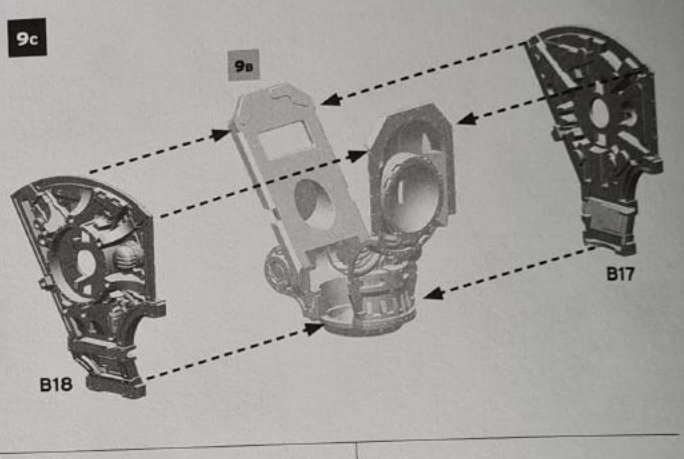
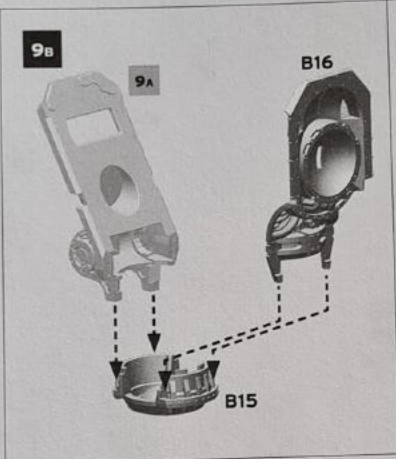
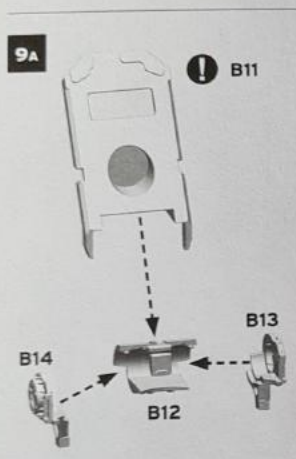
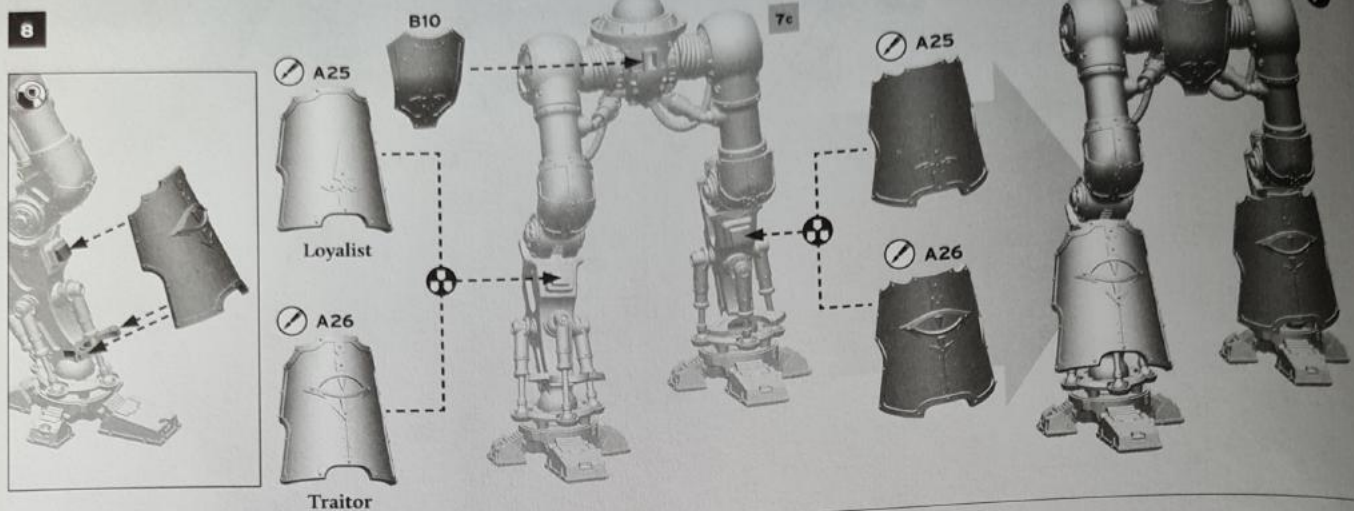

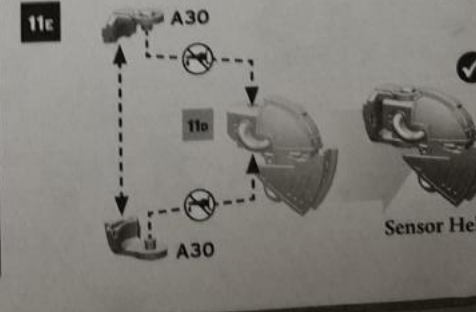
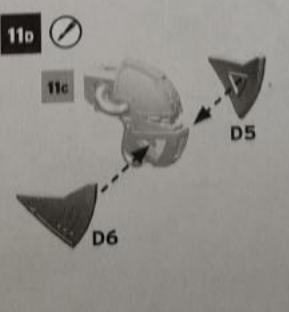
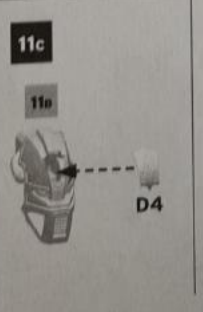
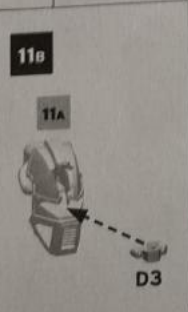
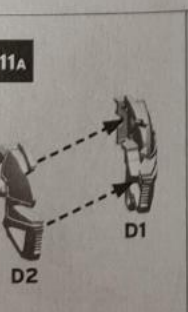
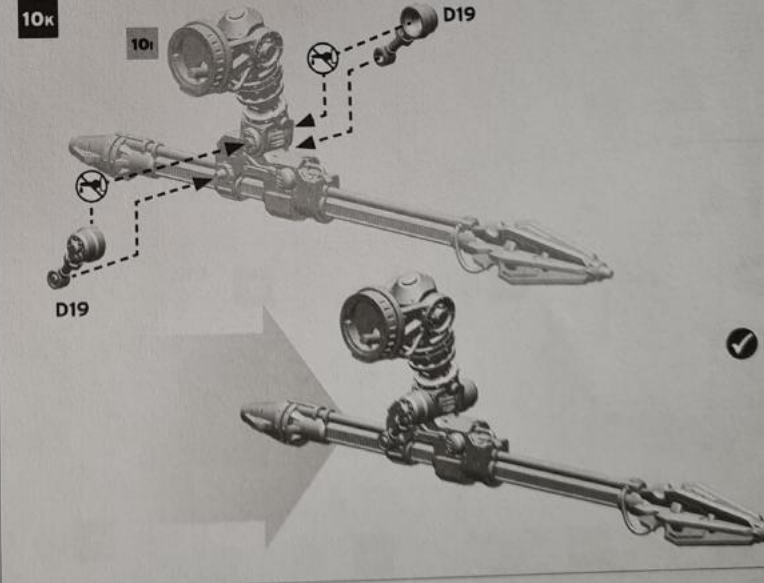
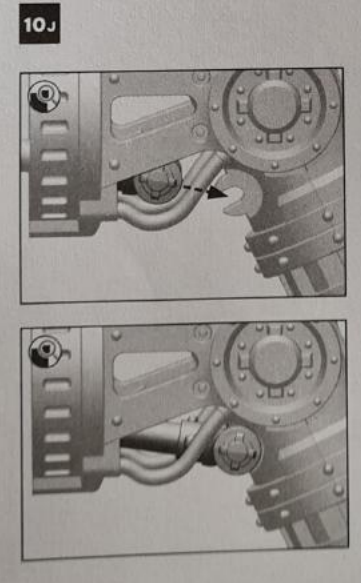
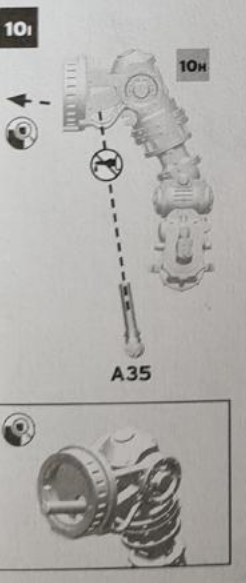
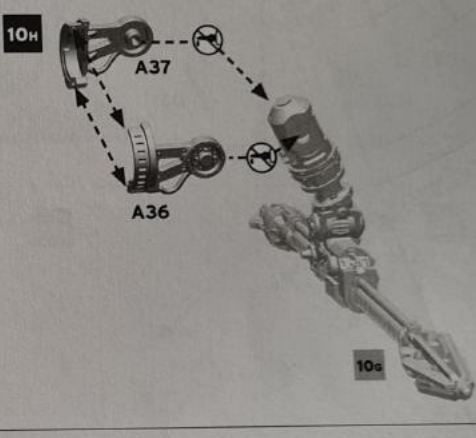
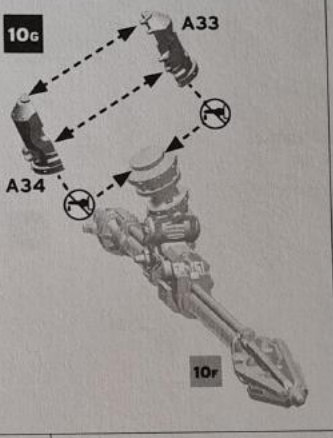
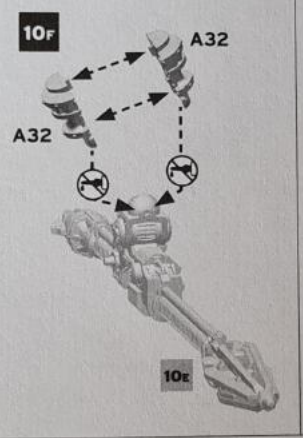
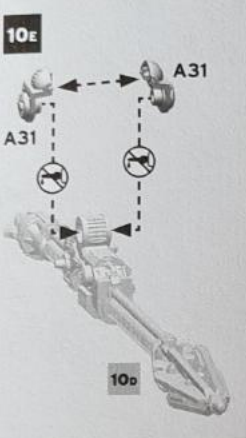
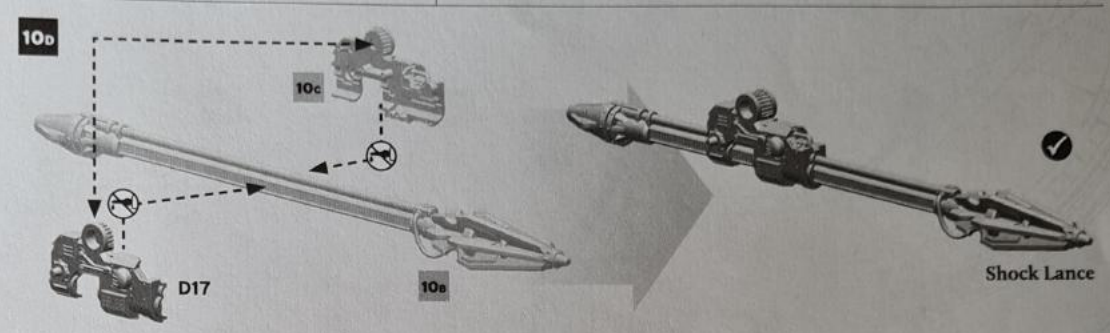
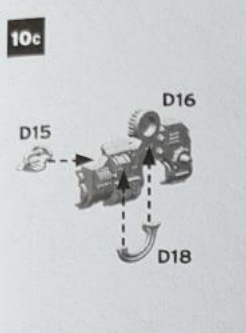
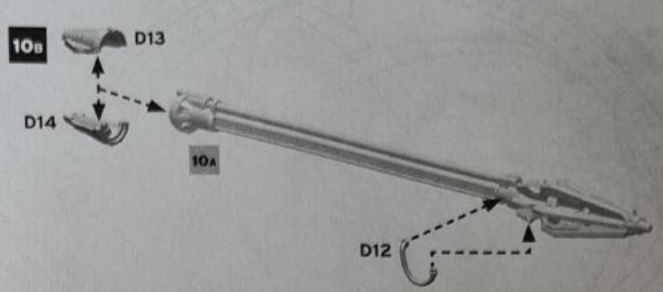
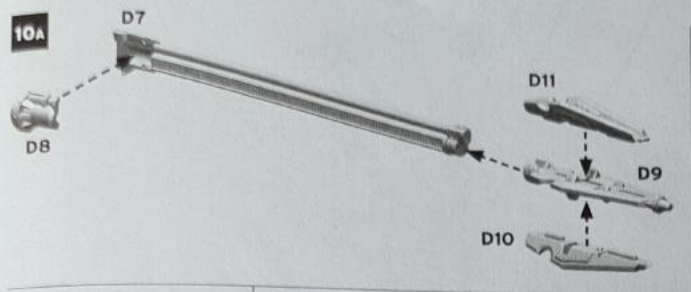



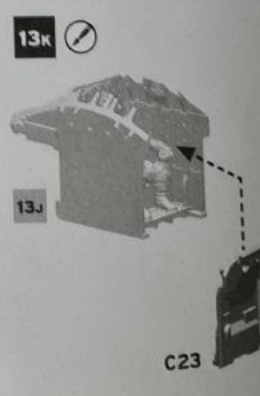
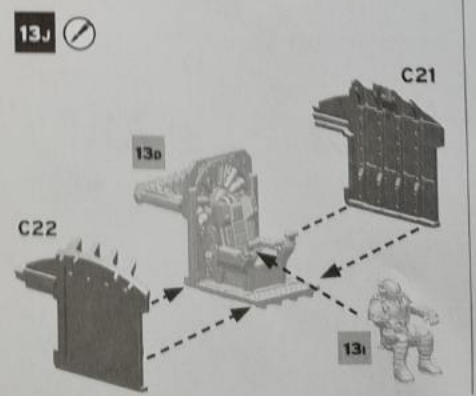
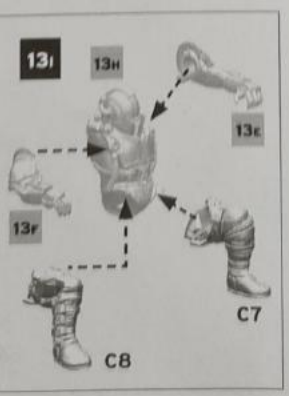
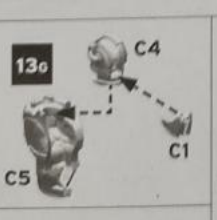
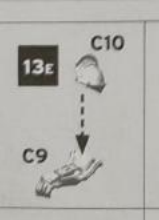
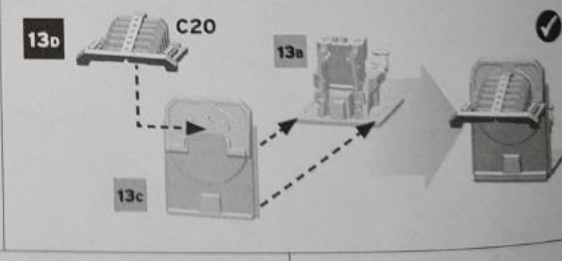
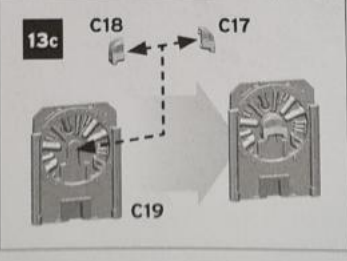
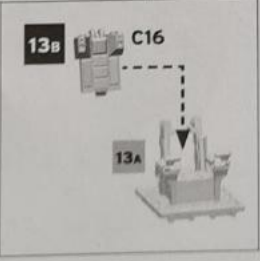
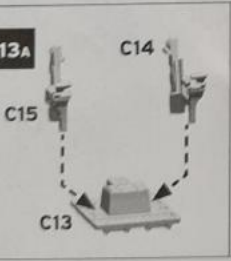
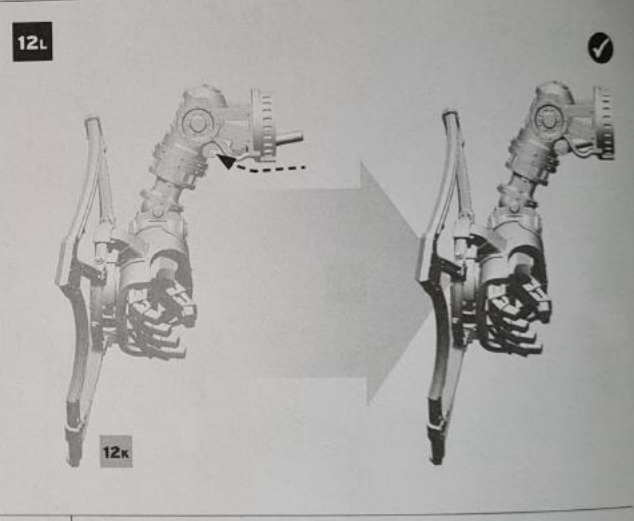
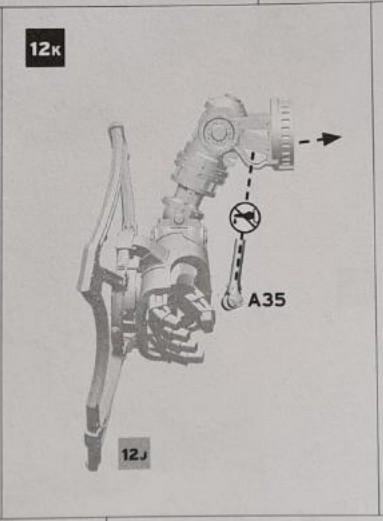
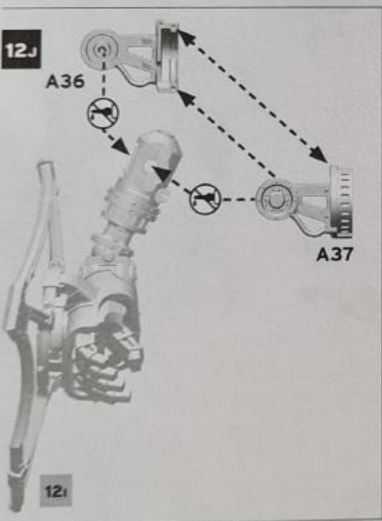
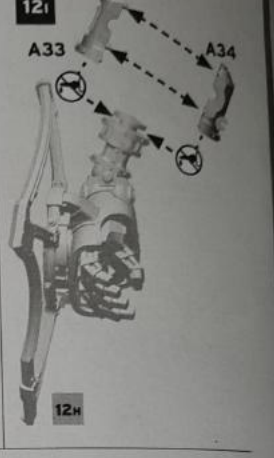
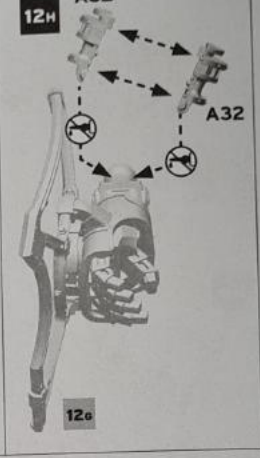
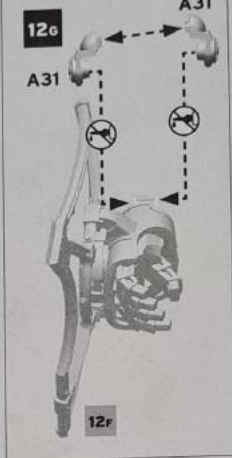
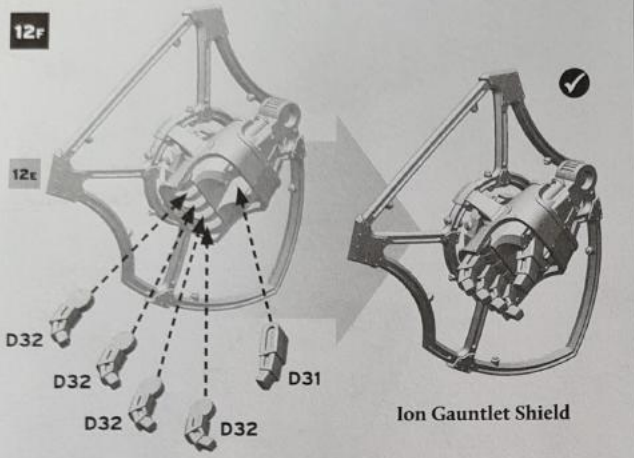
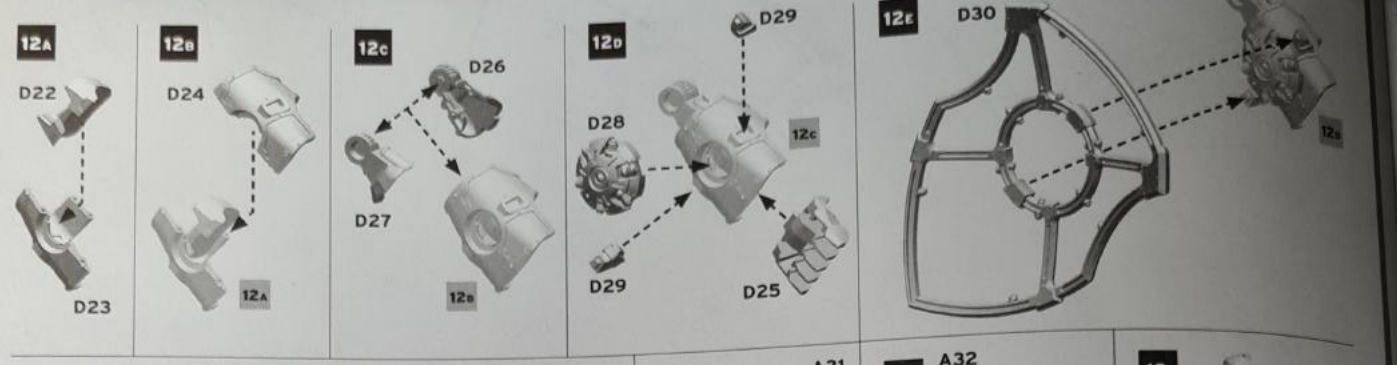

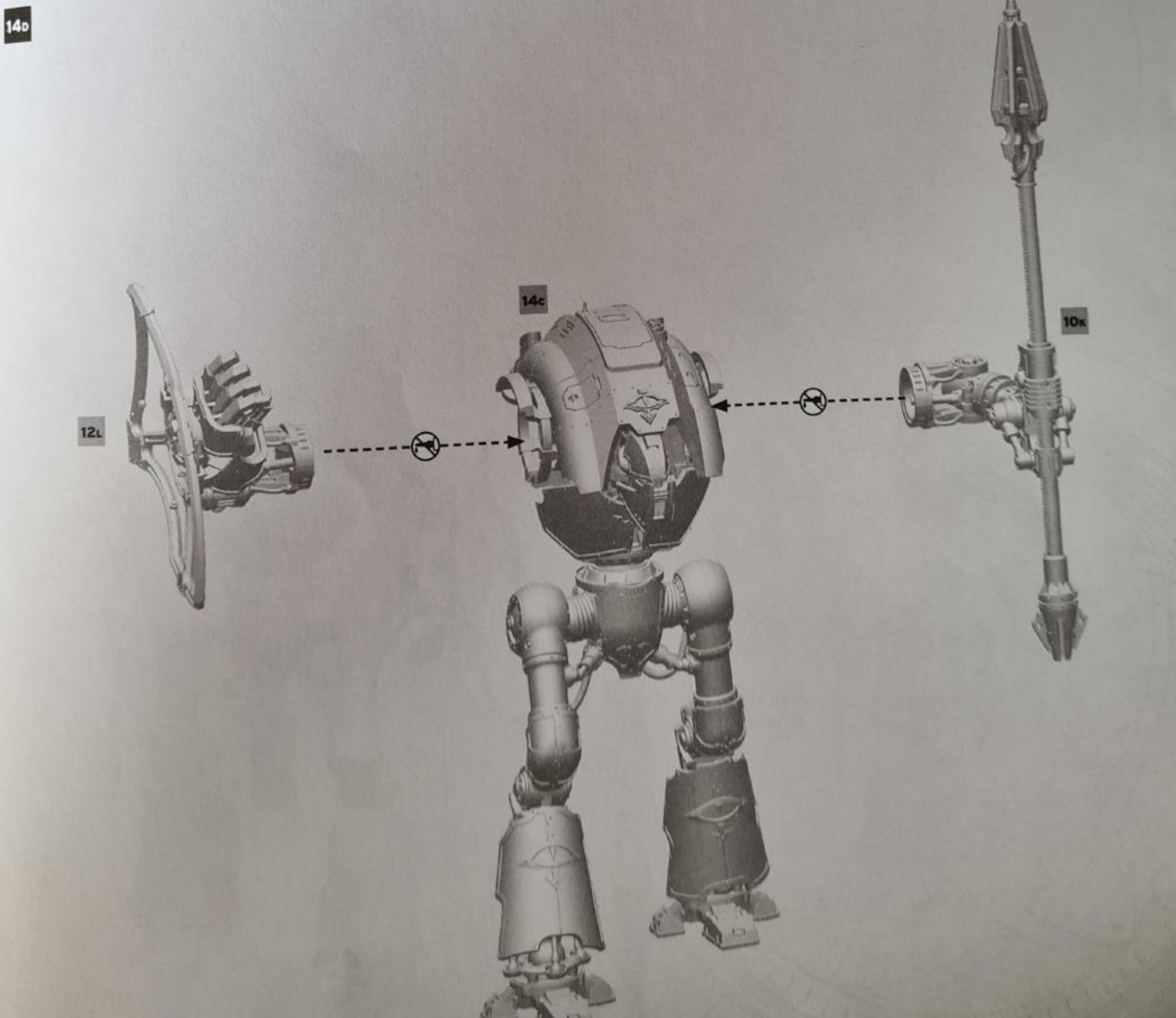
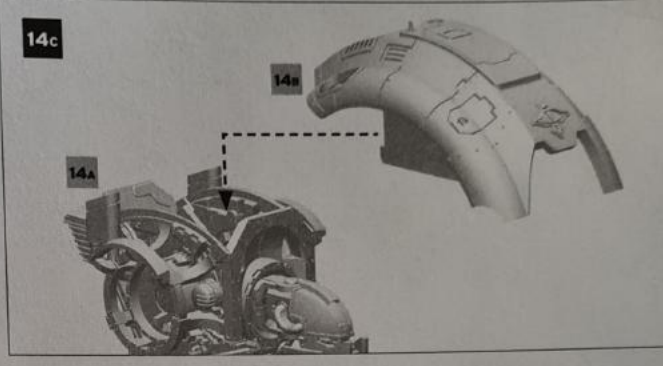
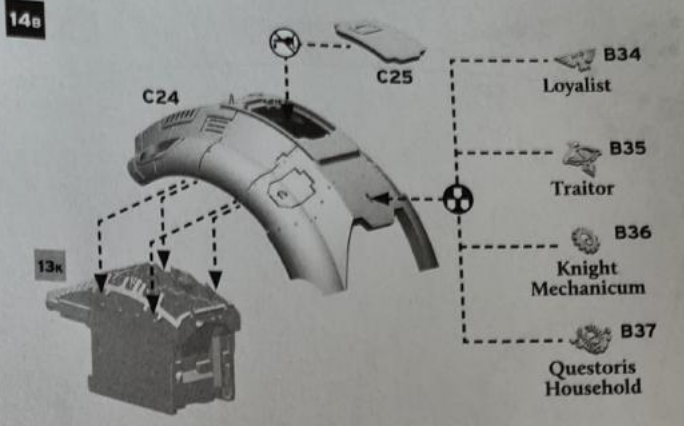
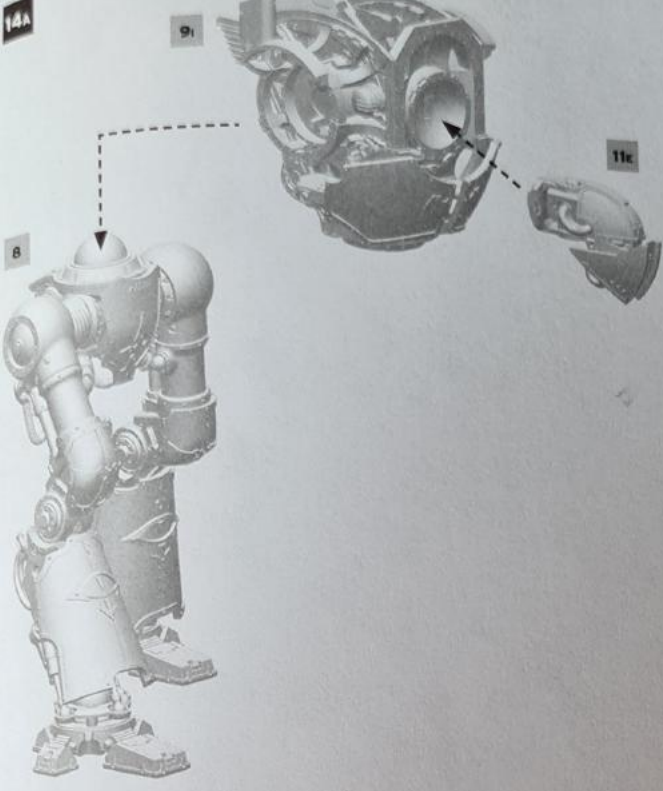



14c

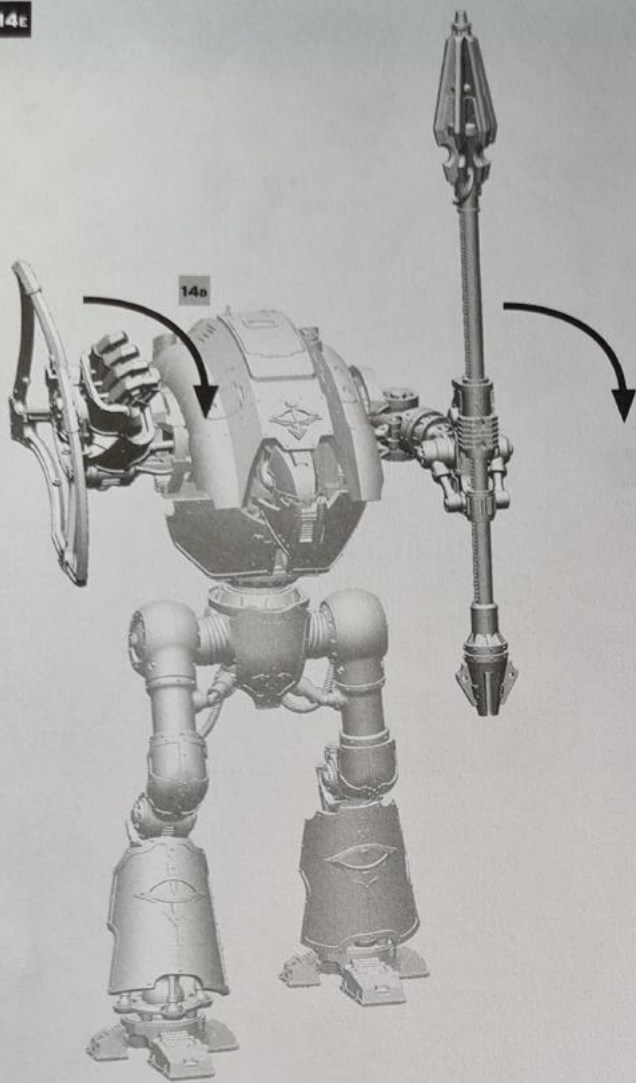

14r

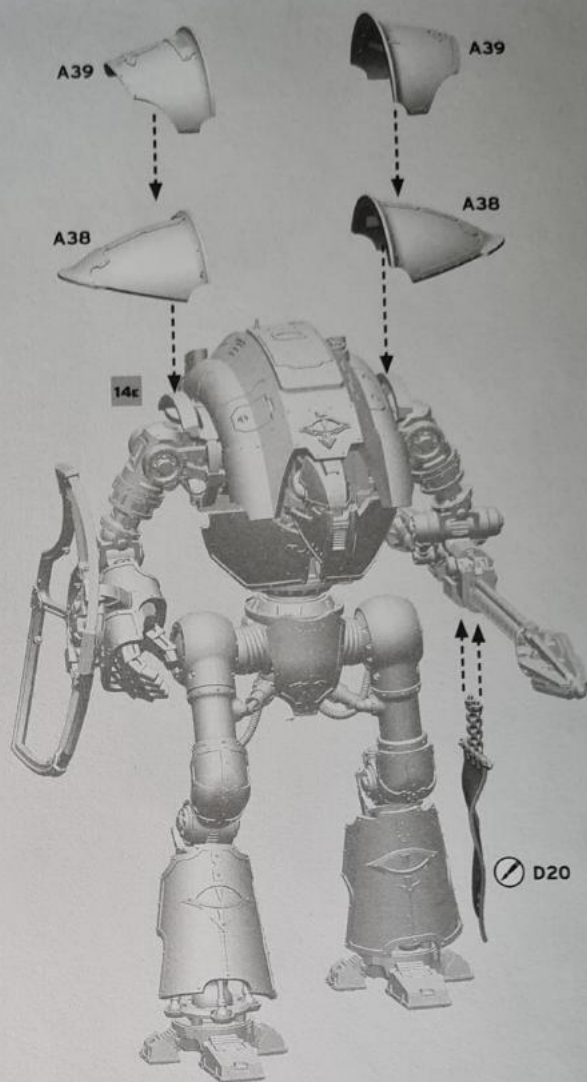

14c

14r

