



Free Downloads of Build Instructions,
Assembly Booklets & How To Guides

BuildInstructions.com

WARHAMMER THE HORUS HERESY

CERASTUS KNIGHT LANCER

READ THIS FIRST | À LIRE EN PRIORITÉ | BITTE BEACHTEN | LEE ESTO PRIMERO
LEGGI PRIMA QUESTO | 最初にお読みください | 请优先阅读

ENG BEFORE ASSEMBLING YOUR MINIATURES, PLEASE READ THROUGH THE INSTRUCTIONS IN THIS BOOKLET CAREFULLY.

A pair of plastic cutters is required to remove the plastic components in this kit from their frame. We advise using a mouldline scraping tool to clean up the parts. To assemble your model you will need plastic glue. Games Workshop sells Citadel Fine Detail Cutters, Citadel Mouldline Removers and Citadel Plastic Glue, but does not recommend these products for use by children under the age of 16 without adult supervision.

FRE AVANT D'ASSEMBLER VOS FIGURINES, VEUILLEZ LIRE ATTENTIVEMENT LES INSTRUCTIONS DE CE LIVRET. Une pince coupante est requise pour détacher chaque élément de sa grappe plastique. Nous vous recommandons l'utilisation d'un ébarboir pour gratter chaque élément. Pour l'assemblage, vous aurez besoin de colle plastique. Games Workshop commercialise les Pinces de Précision Citadel, l'Ébarboir Citadel et la Colle Plastique Citadel, mais n'en recommande pas l'utilisation aux enfants de moins de 16 ans sans la supervision d'un adulte.

SPA POR FAVOR, LEE CUIDADOSAMENTE ESTE LIBRETO DE INSTRUCCIONES ANTES DE EMPEZAR A MONTAR LAS MINIATURAS.

Te harán falta unas tenazas para plástico a fin de separar las piezas de la matriz. También aconsejamos una herramienta para quitar rebabas a fin de limpiar cada pieza. Para montar la miniatura necesitarás pegamento para plástico. Games Workshop vende Tenazas de detalle superfino, Quitarrebabas Citadel y Pegamento para plástico Citadel, pero no recomendamos estos productos a menores de 16 años sin la supervisión de un adulto.

GER VOR DEM ZUSAMMENBAU DER MINIATUREN BITTE DIE ANWEISUNGEN IN DIESER ANLEITUNG AUFMERKSAM DURCHLESEN.

Du benötigst einen Kunststoffseitschneider, um die Kunststoffbauteile aus dem Gussrahmen herauszutrennen. Außerdem empfehlen wir, die Bauteile mit einem Gussgratentferner zu säubern. Um dein Modell zusammenzubauen, benötigst du Kunststoffkleber. Games Workshop bietet Präzisions-Seitenschneider und Gussgratentferner von Citadel sowie Citadel-Kunststoffkleber an, empfiehlt aber, dass Kinder unter 16 Jahren diese nur unter Aufsicht eines Erwachsenen benutzen.

ITA PRIMA DI ASSEMBLARE LE TUE MINIATURE LEGGI ATTENTAMENTE TUTTE LE ISTRUZIONI DI QUESTO LIBRETTO. Sono necessarie un paio di tronchesine per plastica per staccare i componenti dai loro sprue. Consigliamo di usare un attrezzo apposito per pulire i componenti. Per assemblare il modello avrai bisogno di colla per plastica. Games Workshop vende Tronchesine di ultraprecisione Citadel, Attrezzo per ripulire Citadel e Colla per plastica Citadel, ma non consiglia questi prodotti ad un pubblico minore di 16 anni senza la supervisione di un adulto.

JPN 始める前に必ず説明書をお読みください。本キット内のフレームからプラスチックパーツを切り離すためには、ニッパーが必要です。パーツのモールドを平らにするには、専用ツールを使用をお勧めいたします。本キットの組み立てには、プラ用接着剤が必要です。ゲームズワークショップはスーパー・ファインディテール・カッター・シタデル・プラスチックグルー・シタデル・モールドラインリムーバーを販売しておりますが、16歳以下の子供が大人の監督なしにこれらの道具を使用されることをお勧めしません。

CHN 在组装您的微缩模型之前，请仔细阅读本手册中的说明。

您需要一把模型剪将塑料部件从板件上剪下来。我们建议使用模线刮刀来处理零件。组装时您还需要用到塑料胶水。您可以从 Games Workshop 处购买 Citadel 精密剪钳、Citadel 模线刮刀和 Citadel 塑料胶水。但 16 岁以下儿童不得在没有成年人监护的情况下使用这些产品。

16+

Citadel Plastic Glue
Colle plastique liquide Citadel
Pegamento para plástico fluido
Citadel-Kunststoffkleber
Colla per plastica fluida Citadel
シタデルプラスチック接着剤流し込みタイプ
Citadel 塑料粘接剂



Super Fine Detail Cutters
Pince Coupante de Précision
Tenazas de detalle superfino
PRÄZISIONS-SEITENSCHNEIDER
Tronchesine di ultraprecisione
スーパー・ファインディテール・カッター
精密剪钳



Mouldline Remover
Ébarboir
Quita-rebabas
Gussgratentferner
Attrezzo per ripulire
モールドライン・リムーバー
合模线刮刀

EXPLANATION OF SYMBOLS | EXPLICATION DES SYMBOLES EXPLICACIÓN DE SÍMBOLOS | ERLÄUTERUNG DER SYMBOLE LEGENDA DEI SIMBOLI | アイコン解説 | 符号说明

! Assemble last
• Assembler en dernier
• Montar último
• Baue dies zuletzt zusammen
• Assembla per ultimo
• 最後に組み立てよう
• 最后组装

🔍 Detail view
• Vue détaillée
• Vista detallada
• Alternative Ansicht
• Visuale del dettaglio
• 拡大
• 局部放大视图

🚫 Do not glue the components
• Ne pas coller les éléments
• No pegar los componentes
• Bitte die Teile nicht kleben
• Non incollare i componenti
• このパーツは接着不可
• 请勿粘接

🔄 Choice of parts
• Choix d'éléments
• Piezas opcionales
• Auswahl an Teilen
• Scelta di componenti
• パーツの選択
• 选择部件

⚙️ Variant assembly
• Variante d'assemblage
• Variante de montaje
• Bauvariante
• Assemblaggio alternativo
• 組み立てバリエーション
• 多种组装方式

🔪 Shim to allow for different poses
• Couper pour permettre d'autres poses
• Cortar para crear diferentes posiciones
• Für andere Posen abtrennen
• Rimuovi per ottenere pose differenti
• ポーズを変えたい場合は切り取る
• 移除部件获取不同形态

x2 Repeat process
• Répéter l'étape
• Repetir pasos
• Vorgang wiederholen
• Ripeti il processo
• 同じ作業を繰り返すこと
• 重复步骤

✅ Stage complete
• Étape terminée
• Paso completado
• Schritt abgeschlossen
• Fase completa
• このステージの完成
• 完成

🖌️ Paint before assembly
• Peindre avant assemblage
• Pintar antes del montaje
• Erst bemalen, dann zusammenbauen
• Dipinti prima dell'assemblaggio
• 組み立て前にペイントすること
• 组装前涂装

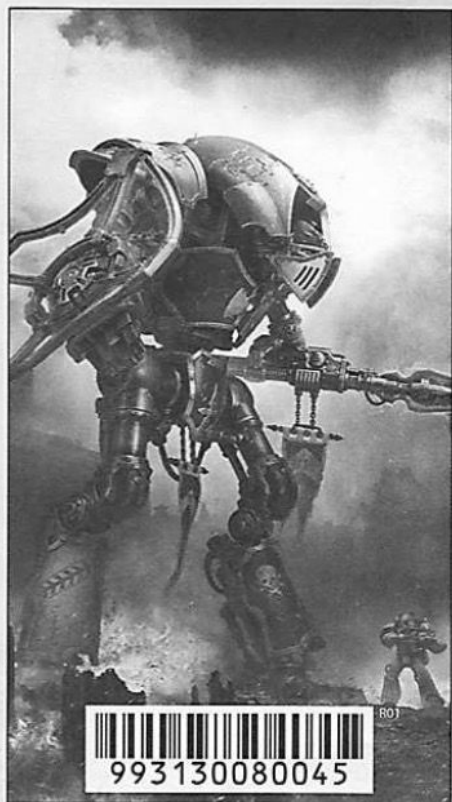

CITADEL
MINIATURES

© Copyright 2023, Games Workshop Ltd. All rights reserved.

93130080045

CERASTUS KNIGHT LANCER

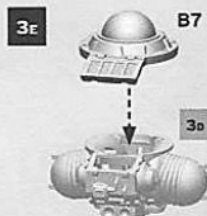
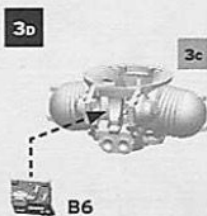
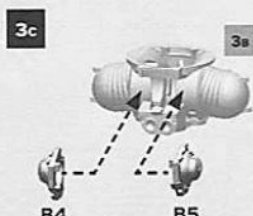
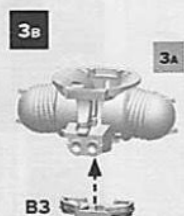
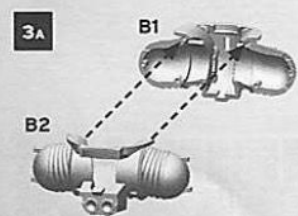
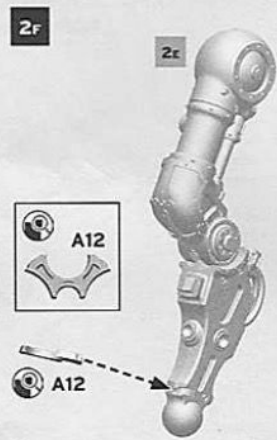
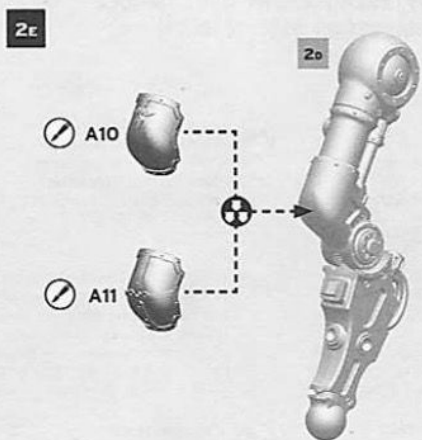
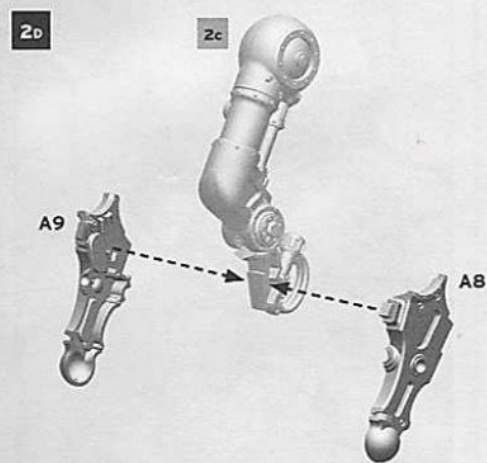
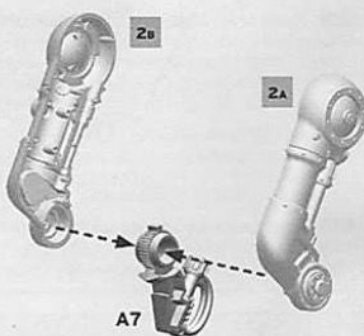
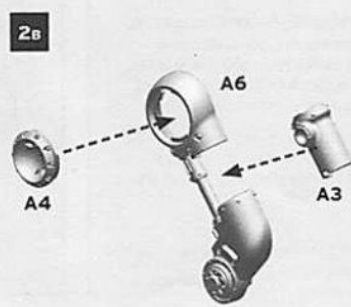
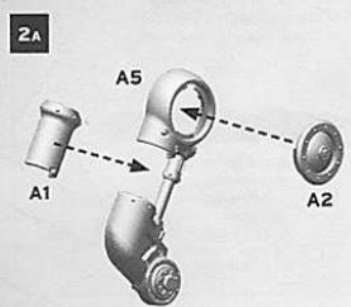
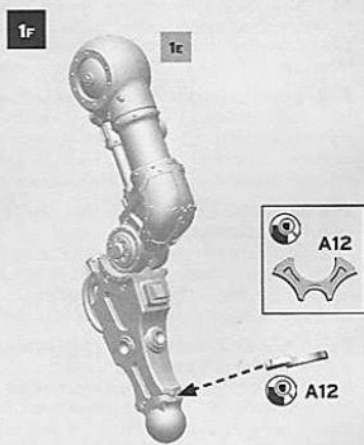
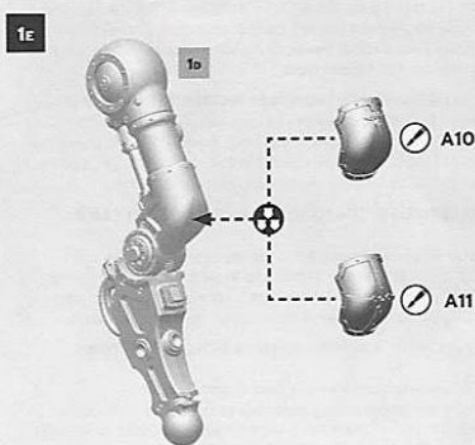
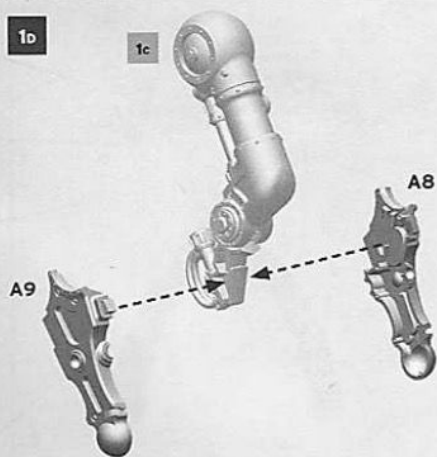
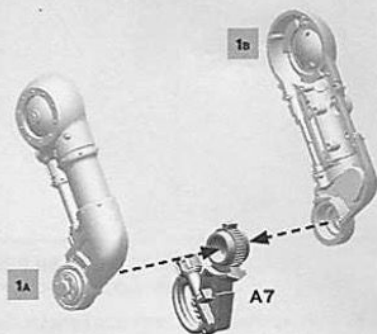
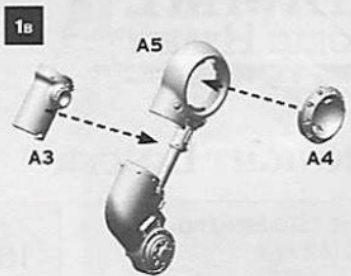
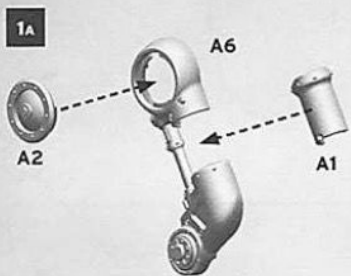

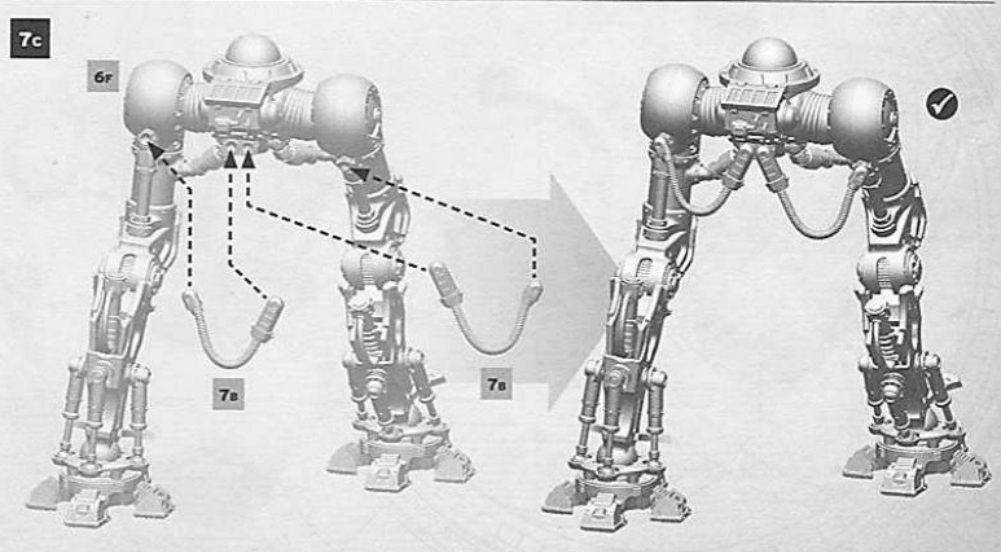
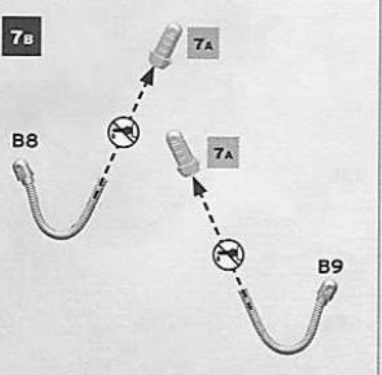
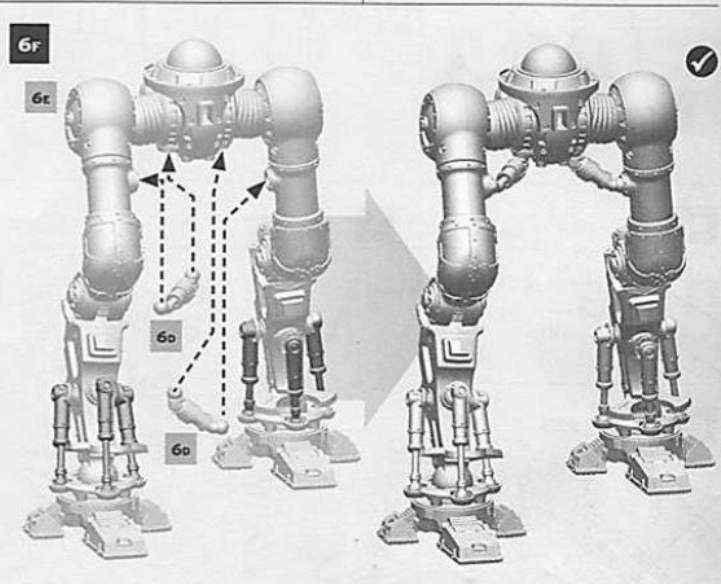
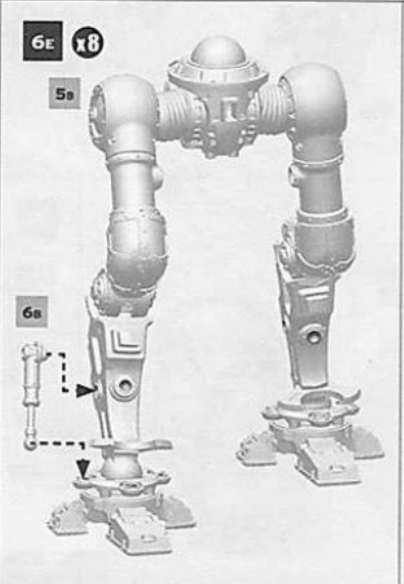
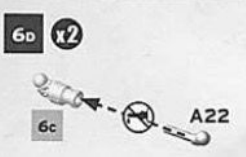
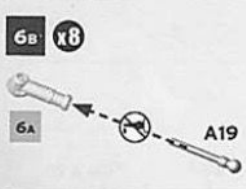
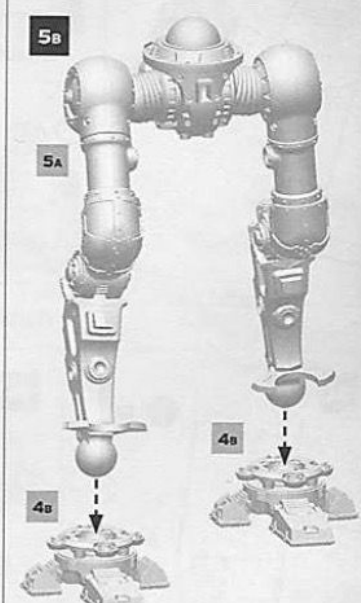
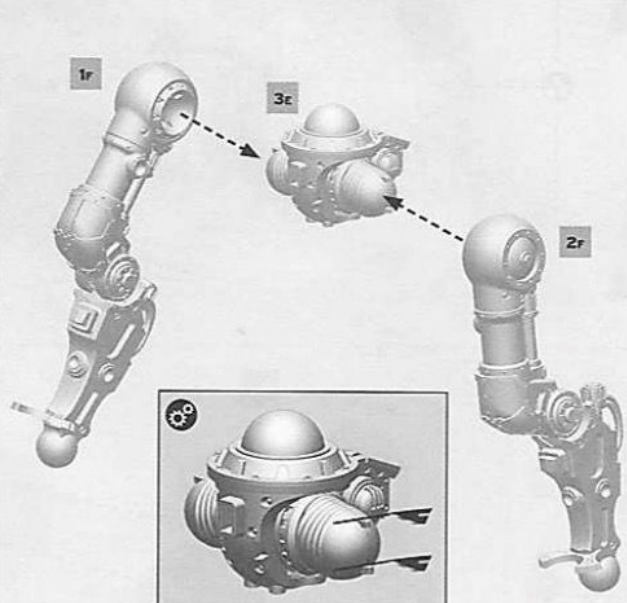
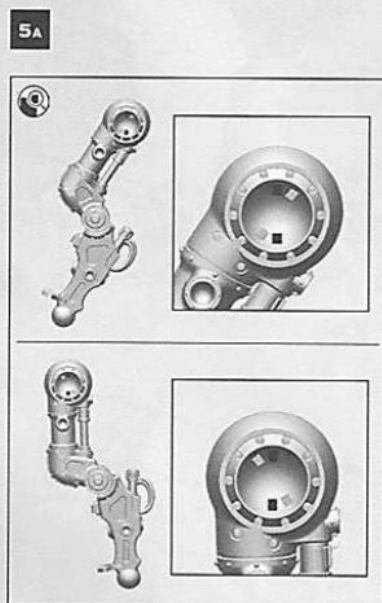
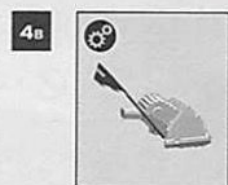
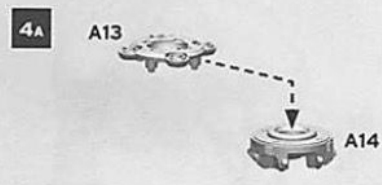

8

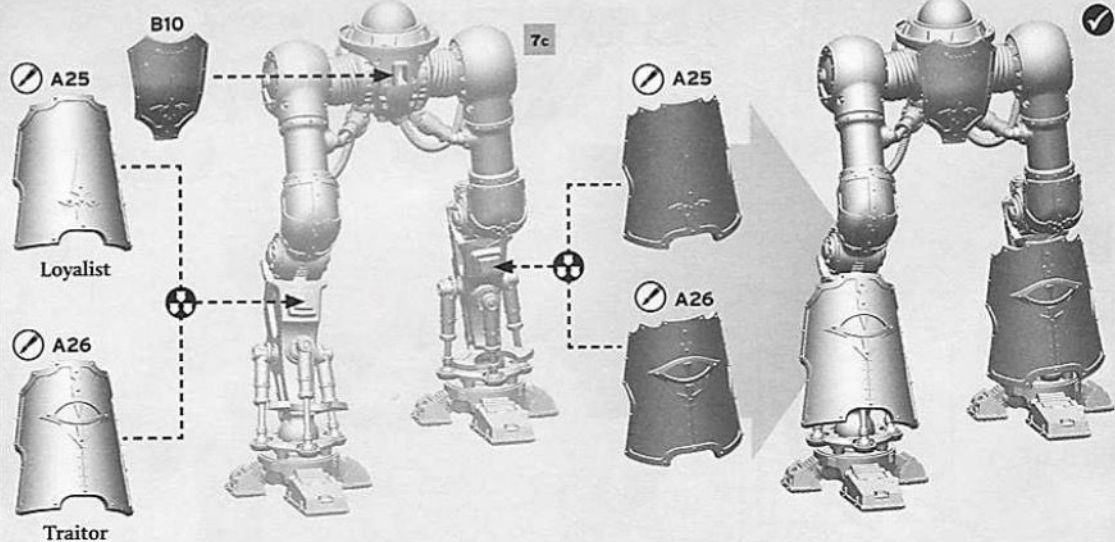
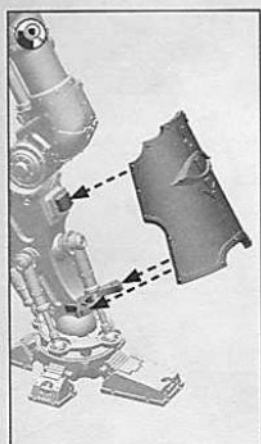

9A

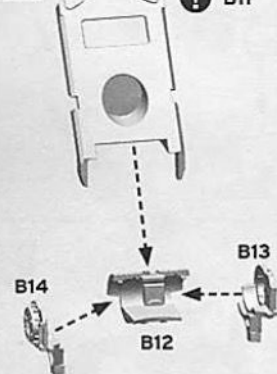

9B

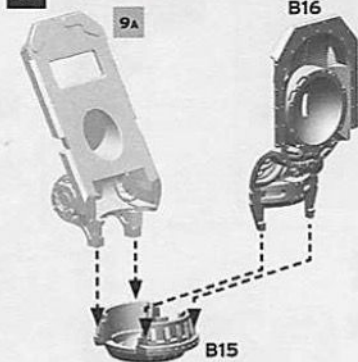

9c

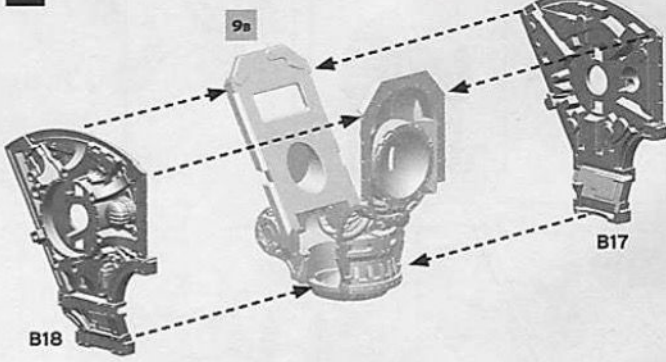

9D

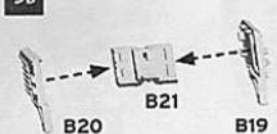

9F

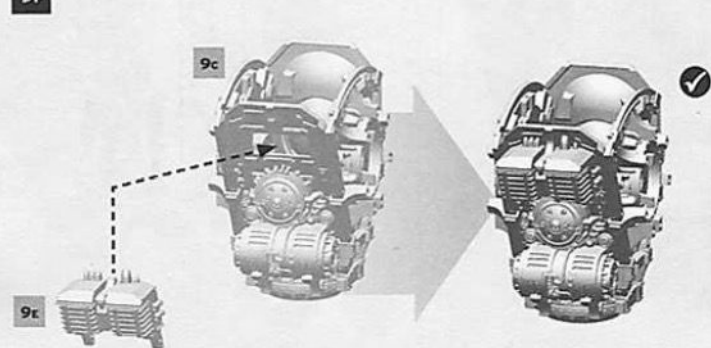

9e

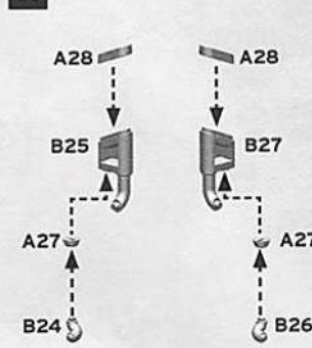

9E

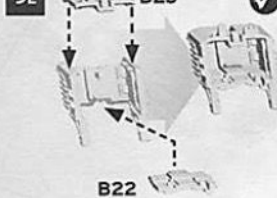

9H

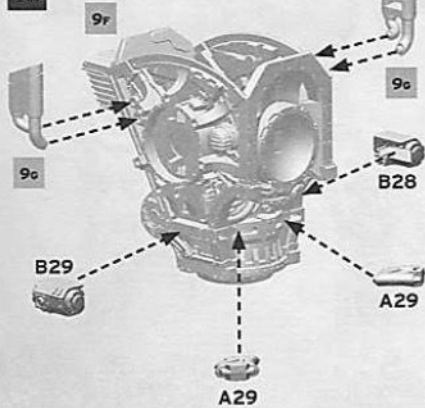

9I

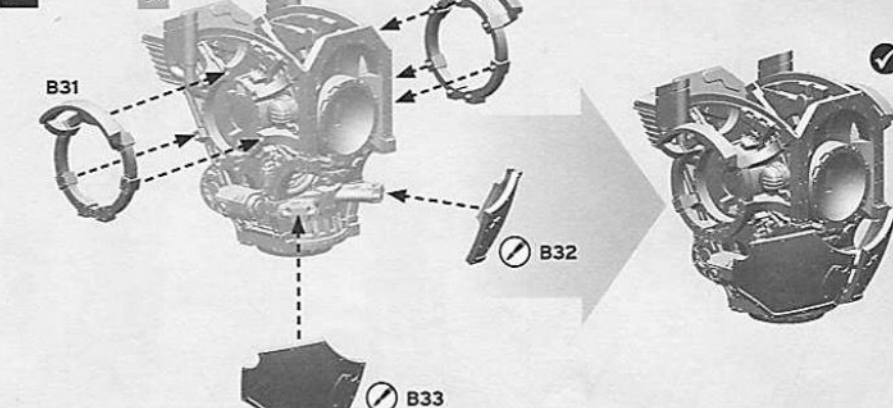

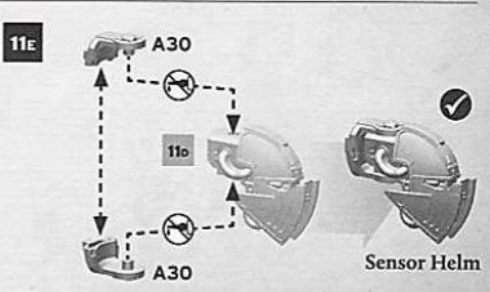
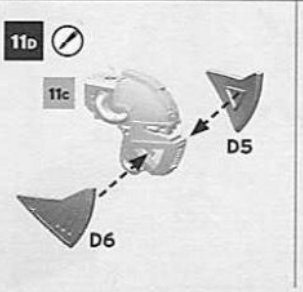
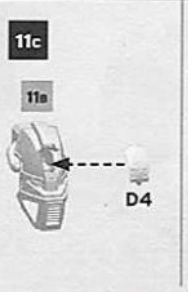
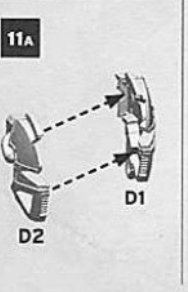
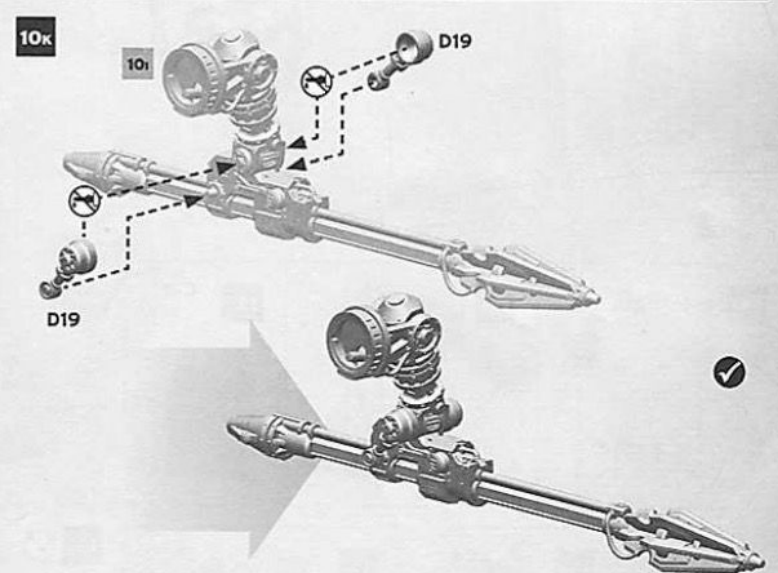
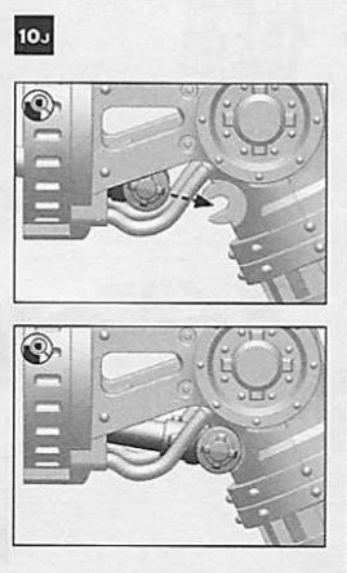
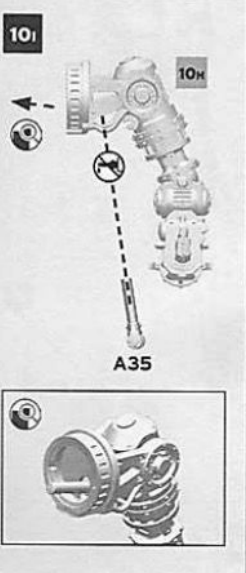
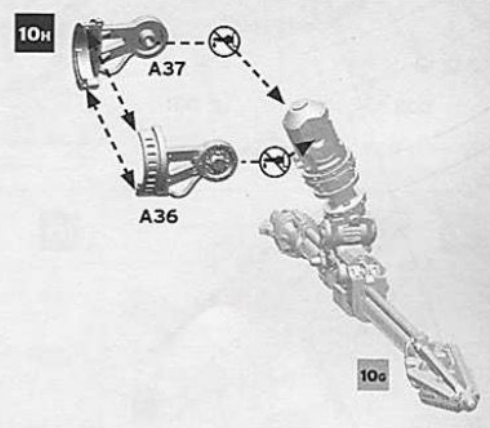
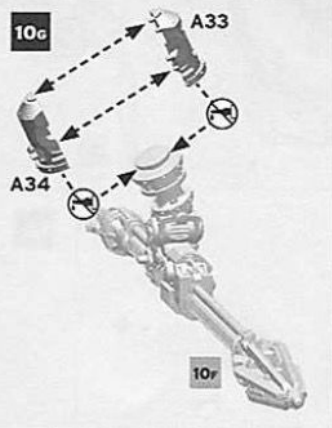
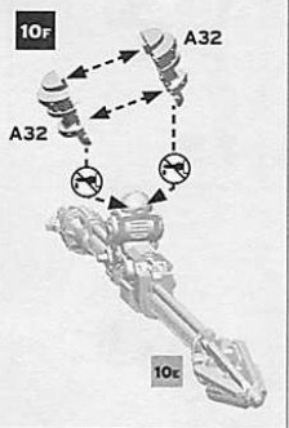
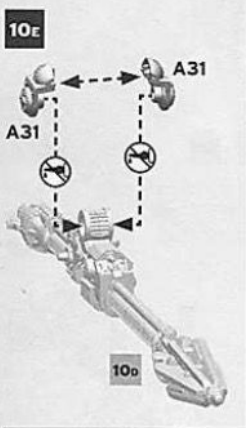
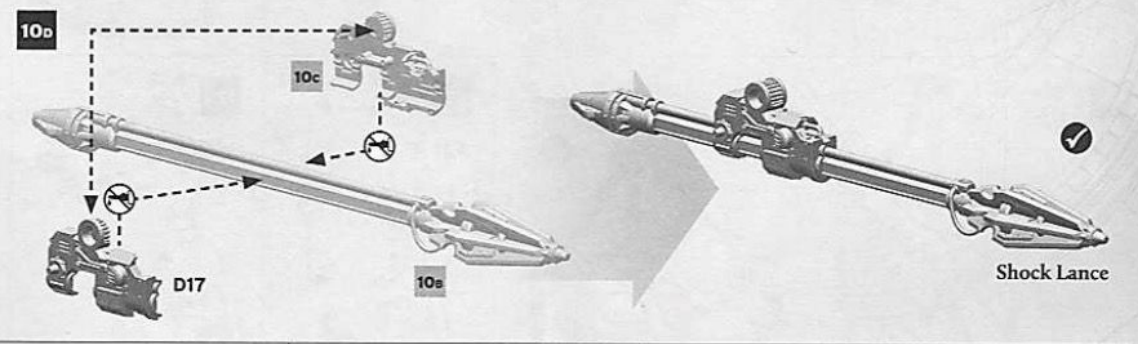
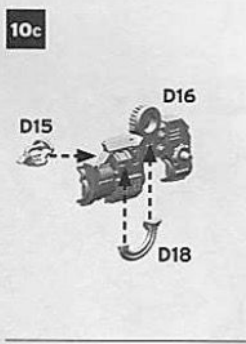
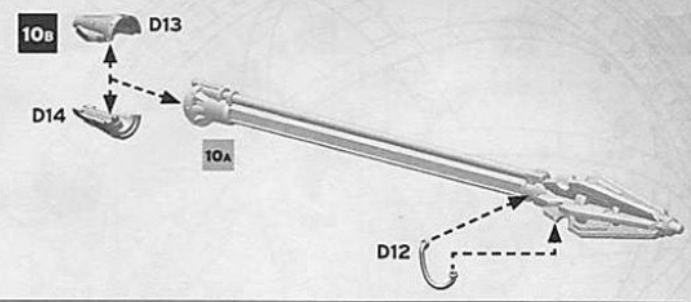
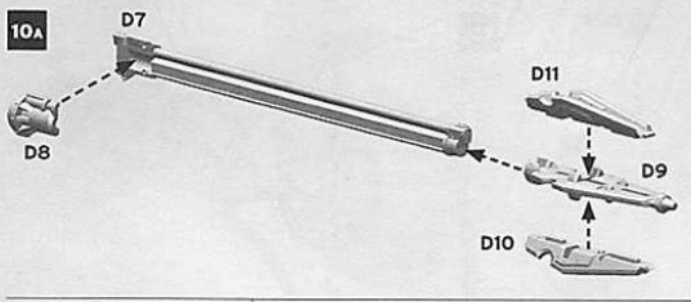

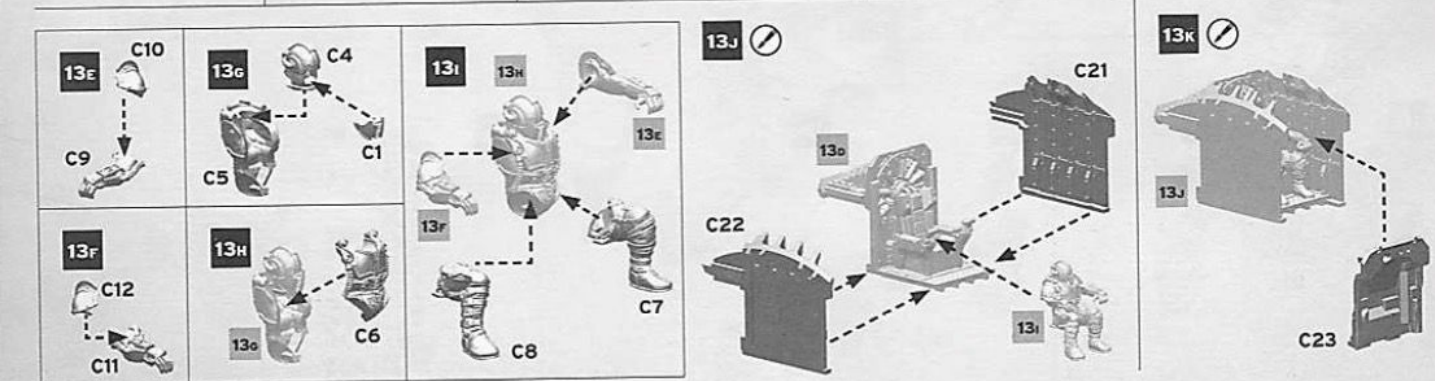
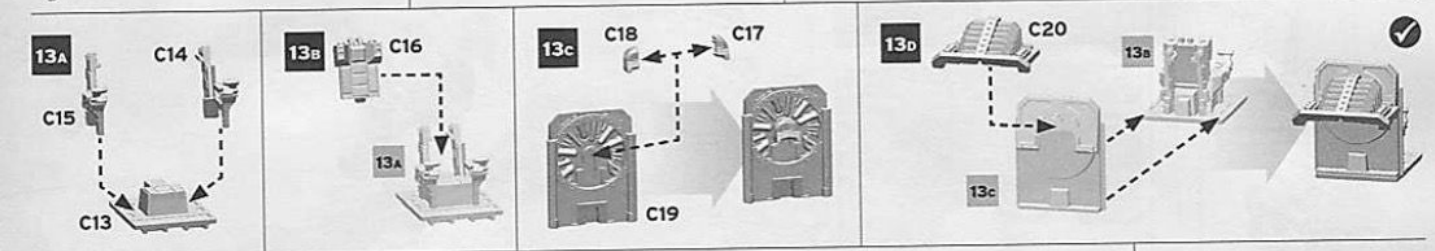
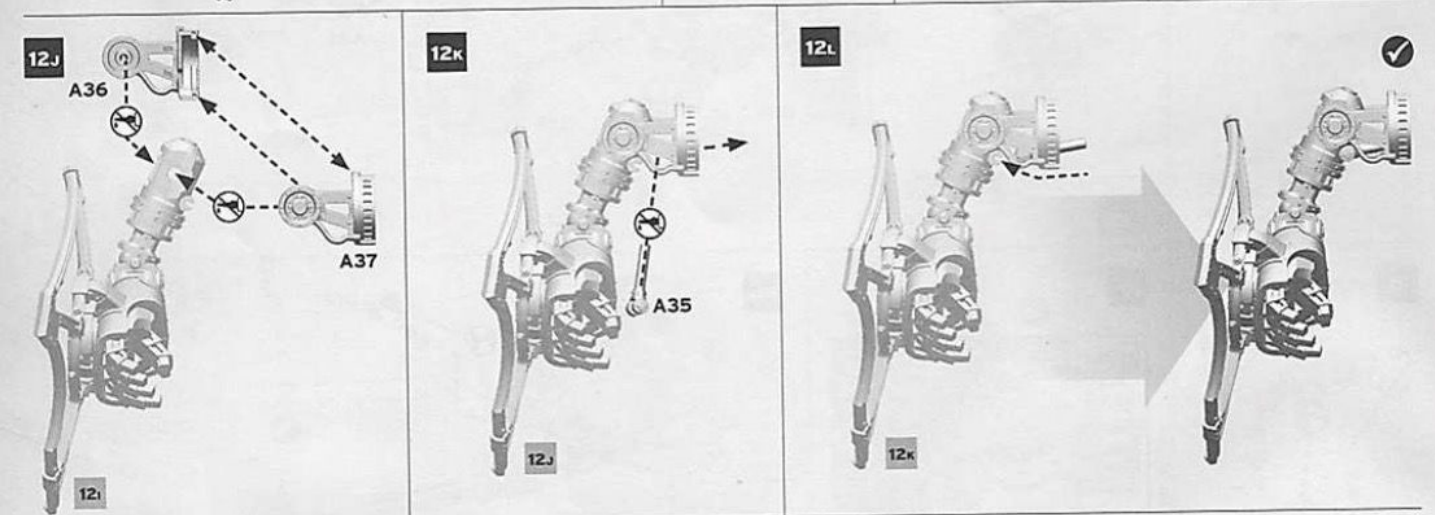
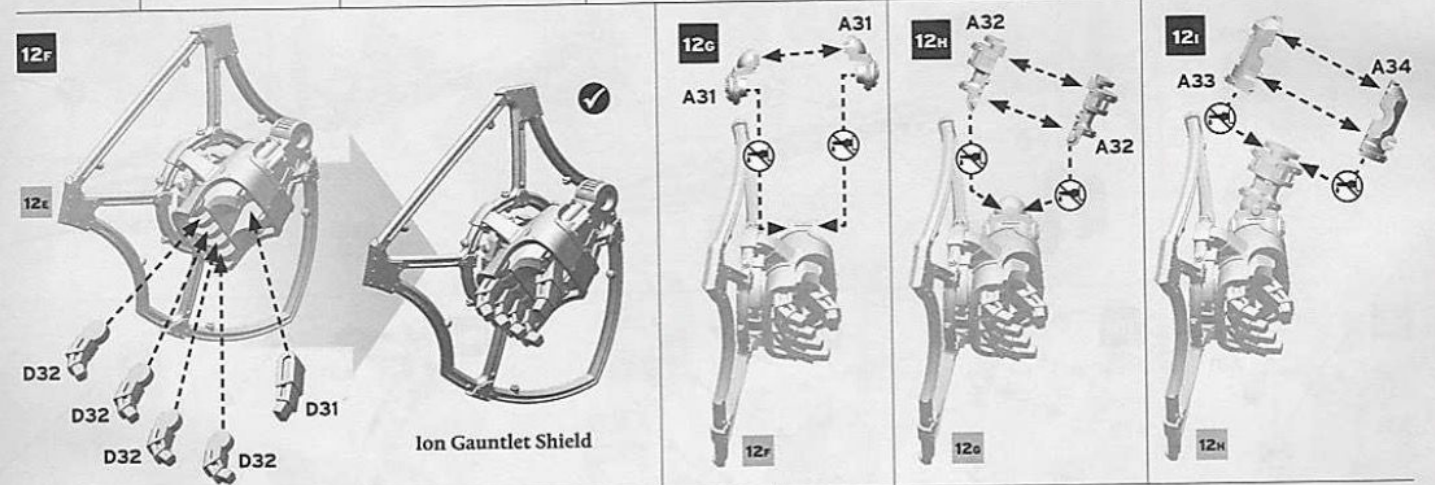
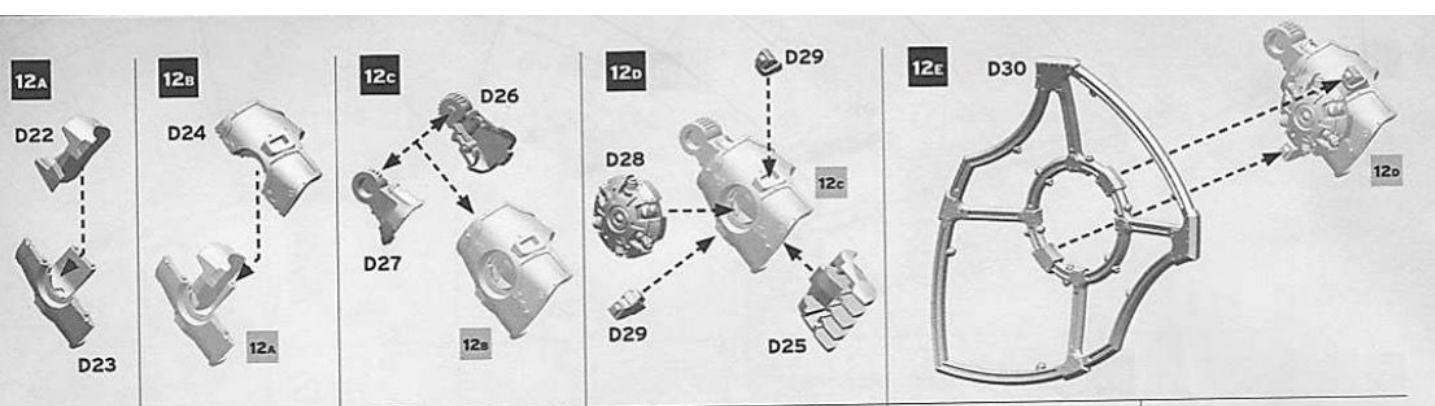

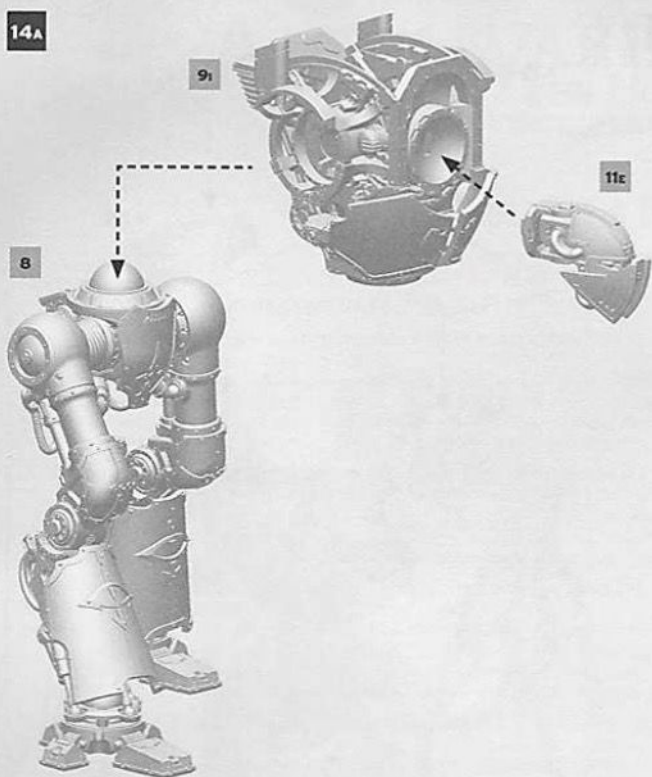
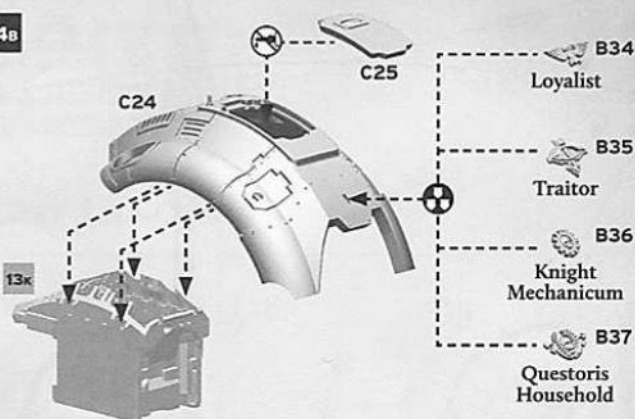
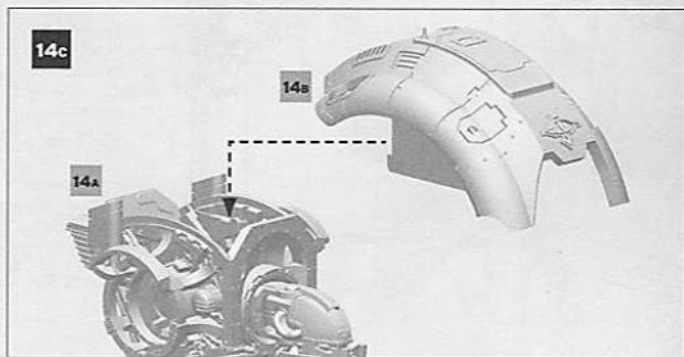
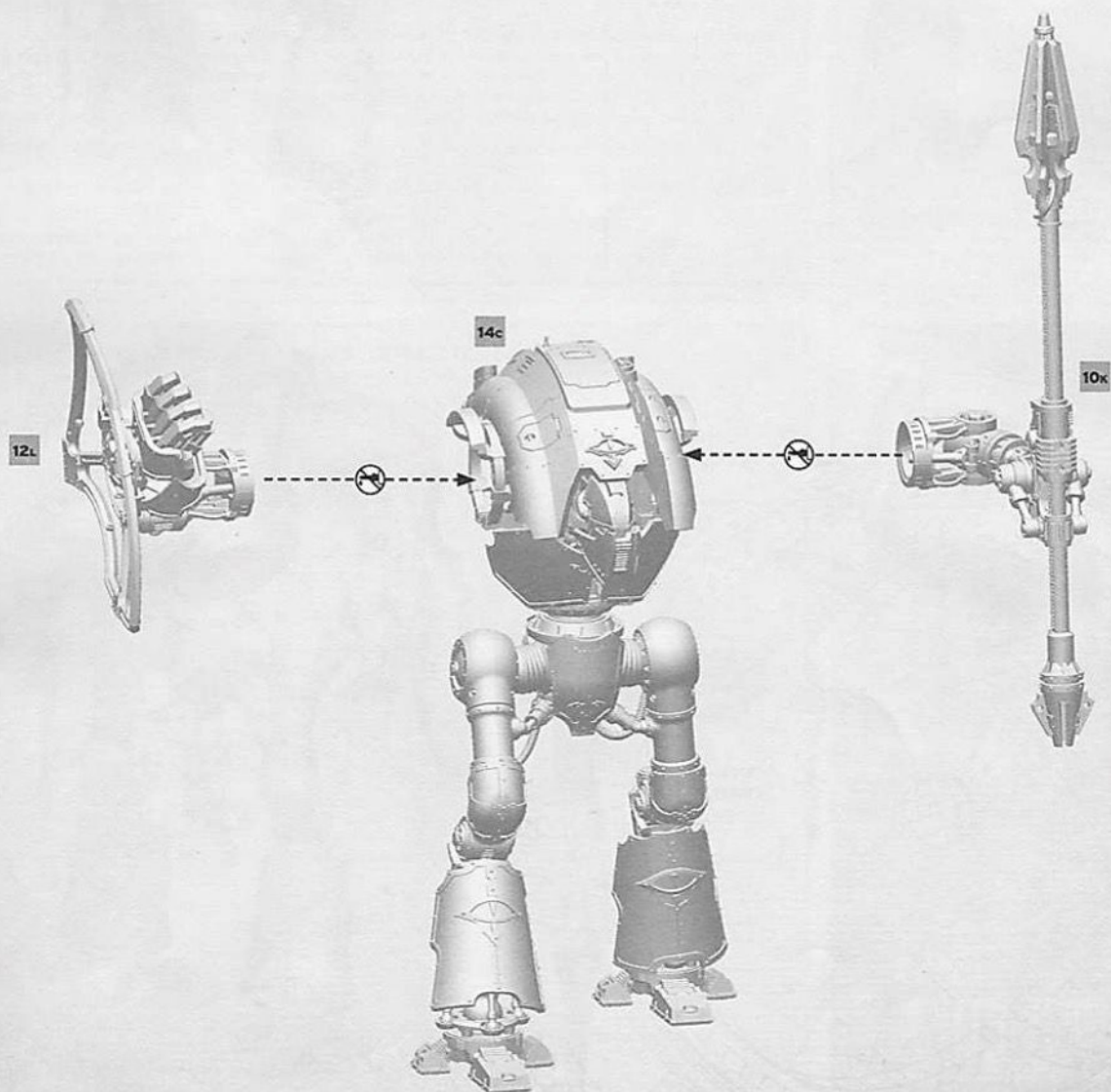
14A**14B****14c****14b**

14e

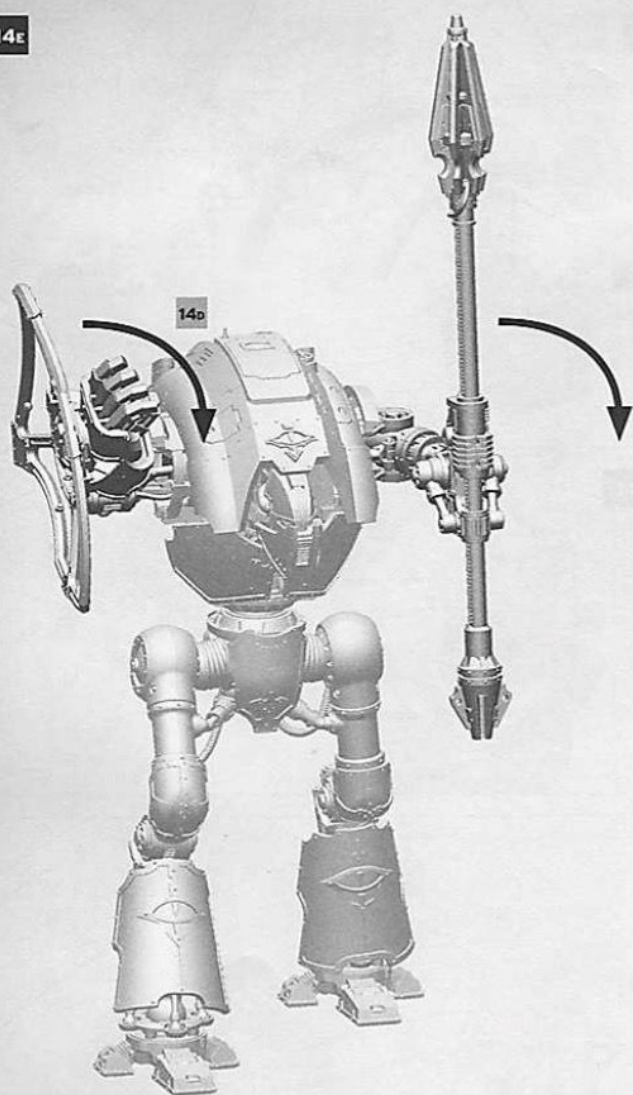

14f

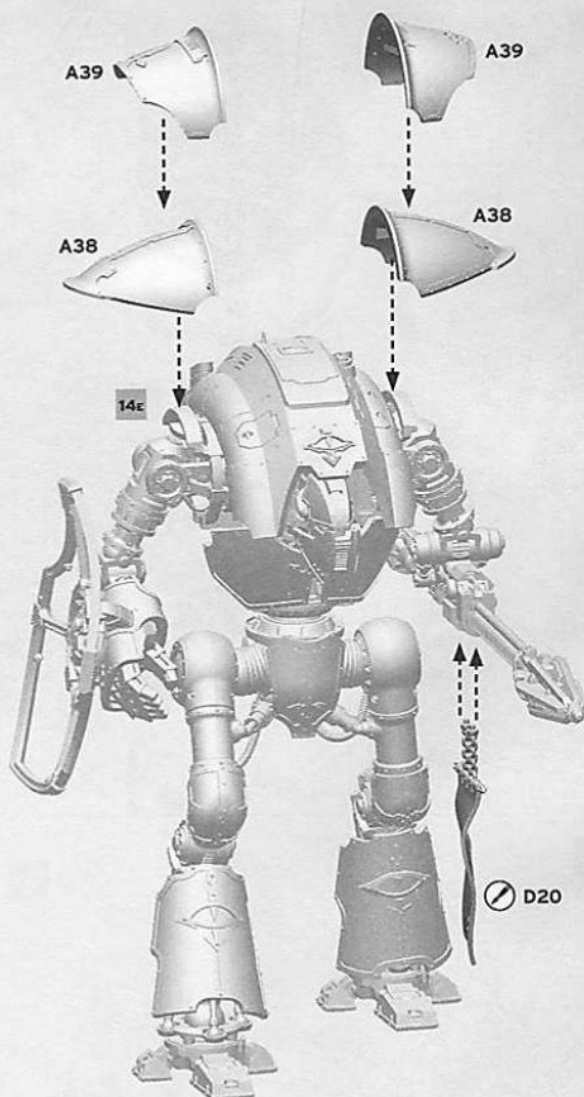

14g

