



Free Downloads of Build Instructions,
Assembly Booklets & How To Guides

BuildInstructions.com

WARHAMMER
40,000

BLACK RAGE: BLOOD ANGELS ARMY SET

RAGE NOIRE : SET D'ARMÉE BLOOD ANGELS | FURIA NEGRA: CAJA DE EJÉRCITO DE ÁNGELES SANGRIENTOS | SCHWARZE WUT: ARMEESET DER BLOOD ANGELS
RABBIA NERA: SET D'ARMATA DEI BLOOD ANGELS | 黒き怒り: ブラッドエンジェル・アーミーセット | 黑色狂怒: 圣血天使军队套装



! READ THIS FIRST | À LIRE EN PRIORITÉ | BITTE BEACHTE | LEE ESTO PRIMERO | LEGGI PRIMA QUESTO | 最初にお読みください。| 请优先阅读

ENG BEFORE ASSEMBLING YOUR MINIATURES, PLEASE READ THROUGH THE INSTRUCTIONS IN THIS BOOKLET CAREFULLY. A pair of plastic cutters is required to remove the plastic components in this kit from their frame. We advise using a mouldline scraping tool to clean up the parts. To assemble your model you will need under the age of 16 without adult supervision.

FR AVANT D'ASSEMBLER VOS FIGURINES, VEUILLEZ LIRE ATTENTIVEMENT LES INSTRUCTIONS DE CE LIVRET. Une pince coupante est requise pour détacher chaque élément de sa grappe. Nous vous recommandons l'utilisation d'un grattoir pour ébarber les éléments. Pour l'assemblage, vous aurez également besoin de colle plastique. Games Workshop commercialise les Pinces de Précision Citadel, l'Ebarboir Citadel et la Colle Plastique Citadel, mais n'en recommande pas l'utilisation pour des enfants de moins de 16 ans sans la supervision d'un adulte.

SPA POR FAVOR, LEE CUIDADOSAMENTE ESTE LIBRETO DE INSTRUCCIONES ANTES DE EMPEZAR A MONTAR LAS MINIATURAS. Te harán falta unas tenazas para plástico a fin de separar las piezas de la matriz. También aconsejamos una herramienta para rebabas a fin de limpiar cada pieza. Para montar la miniatura necesitarás pegamento para plástico. Games Workshop vende Tenazas Citadel, Herramientas para rebabas Citadel y Pegamento para plástico Citadel, pero no recomienda estos productos a menores de 16 años sin la supervisión de un adulto.

GER VOR DEM ZUSAMMENBAU DER MINIATUREN BITTE DIE ANWEISUNGEN IN DIESER ANLEITUNG AUFMERKSAM DURCHLESEN. Du benötigst einen Kunststoffseitschneider, um die Kunststoffbauteile aus dem Gussrahmen herauszutrennen, und Kunststoffkleber, um die Miniatur zusammenzubauen. Außerdem empfehlen wir, die Bauteile vorher mit einem Gussgratentferner zu säubern. Games Workshop bietet Präzisions-Kunststoffseitschneider von Citadel sowie Citadel-Kunststoffkleber an, empfiehlt aber, dass Kinder unter 16 Jahren diese nur unter Aufsicht eines Erwachsenen benutzen.

ITA PRIMA DI ASSEMBLARE LE TUE MINIATURE LEGGI ATTENTAMENTE TUTTE LE ISTRUZIONI DI QUESTO LIBRETTO. Sono necessarie un paio di tronchesine per plastica per staccare i componenti dai loro sprue. Consigliamo di usare un attrezzo apposito per pulire i componenti. Per assemblare il modello avrai bisogno di colla per minore di 16 anni senza la supervisione di un adulto.

日本語 ミニチュアを組み立てる前に、この冊子の説明をよくお読みください。本キット内のフレームからプラスチックパーツを切り離すためには、ニッパーが必要です。パーツのモールドを平らにするには、専用ツールを使用をお勧めいたします。本キットの組み立てには、プラ用接着剤が必要です。ゲームワークショップはシタデル・ニッパー、プラ用接着剤、シタデル・モールドラインリムーバーを販売しておりますが、16歳以下の子供が大人の監督なしにこれらの道具を使用されることをお勧めしません。

中文 组装模型前请仔细阅读本手册中的说明。你需要一把模型剪将塑料部件从板件上剪下来。我们建议使用分模线刮刀来处理零件。组装时你还需要用到模型胶水。你可以从 Games Workshop 处购买到 Citadel Fine Detail Cutter 模型剪、Citadel Mouldline Remover 分模线刮刀和 Citadel Plastic Glue 模型胶，但 16 岁以下儿童不得在没有成年人监护的情况下使用这些产品。

EXPLANATION OF SYMBOLS | EXPLICATION DES SYMBOLES | EXPLICACIÓN DE SÍMBOLOS | ERLÄUTERUNG DER SYMBOLE | LEGENDA DEI SIMBOLI | アイコン解説 | 符号说明

- | | | | |
|---|--|--|---|
| <p>!</p> <ul style="list-style-type: none"> Special instruction - take care Instruction spéciale - faites attention Instrucciones especiales - presta atención Besondere Anweisung - bitte beachten Istruzioni speciali: prestare attenzione 特記事項 - 要注意 特别说明 - 小心 | <p></p> <ul style="list-style-type: none"> Variant assembly Variante d'assemblage Variante de montaje Bauvariante Assemblaggio alternativo 組み立てバリエーション 多种组装方式 | <p></p> <ul style="list-style-type: none"> Choice of parts Choix éléments Modelos de componentes Auswahl an Teilen Scelta di componenti パーツの選択 选择部件 | <p>≤2</p> <ul style="list-style-type: none"> Build the number required, up to the limit shown Assembler le nombre requis, jusqu'à la limite indiquée Monta la cantidad requerida, hasta el limite mostrado Bau die benötigte Anzahl, bis zum angegebenen Limit Assembla il numero richiesto, fino al limite indicato 示されている上限を超えないように、必要数を組み立てること 按要求数量组装直至上限 |
| <p>x2</p> <ul style="list-style-type: none"> Build this many Assembler cette quantité Monta esta cantidad Angegebene Anzahl bauen Assemblane il numero indicato この数だけ組み立てること 重复步骤 | <p></p> <ul style="list-style-type: none"> Dry fit stage before gluing Tester avant de coller Comprobar el encaje antes de pegar Positionierung erst ohne Klebstoff ausprobieren Prova a secco prima di incollare 接着前にひびたり合わせる 粘接前的假组阶段 | <p></p> <ul style="list-style-type: none"> Use matching parts Utiliser les éléments correspondants Usa las piezas que correspondan Verwende die passenden Teile Usa le parti corrispondenti 適合するパーツを使用 使用匹配部件 | <p></p> <ul style="list-style-type: none"> Do not glue the components Ne pas coller les éléments No pegar los componentes Bitte die Teile nicht kleben Non incollare i componenti このパーツは接着不可 请勿粘接 |
| | | | <p></p> <ul style="list-style-type: none"> Stage complete Étape terminée Paso completado Schritt abgeschlossen Fase completa このステージの完成 完成 |

BUILD VARIANTS | VARIANTES D'ASSEMBLAGE | VARIANTES DE MONTAJE | BAUVARIANTEN | VARIANTI D'ASSEMBLAGGIO | バリエーション | 变体版

- !**
- Assemblies for build variants are colour coded.
 - Les assemblages de variantes ont un code couleur.
 - Las instrucciones para montajes alternativos se indican con un color diferente.
 - Optionen für Bauvarianten sind farblich markiert.

- Le diverse varianti d'assemblaggio sono divise per colore.
- バリエーション違いの組み立ては色分けされている。
- 变体版拼装部件有颜色区分



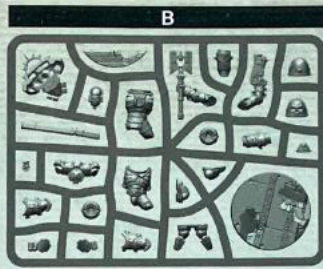
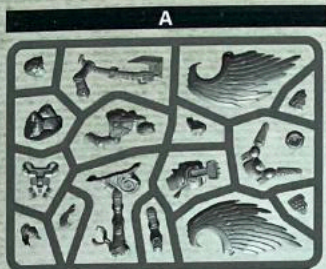

Ø 32mm

x20

Ø 40mm

x2

Ø 90mm

x1

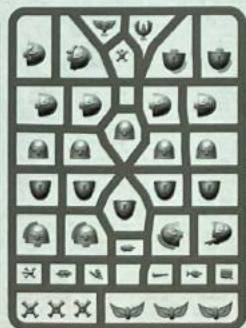
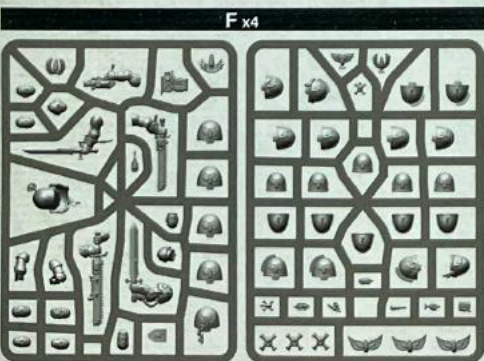
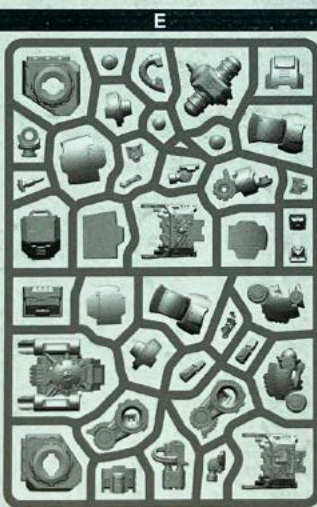
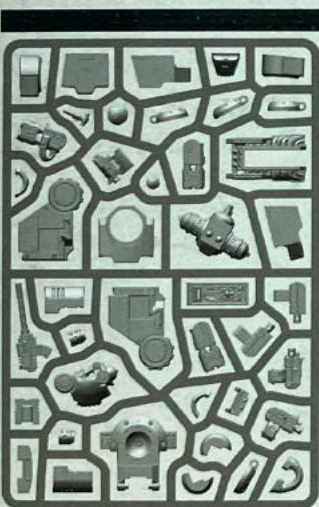
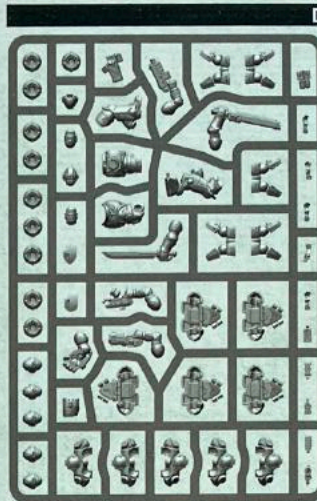
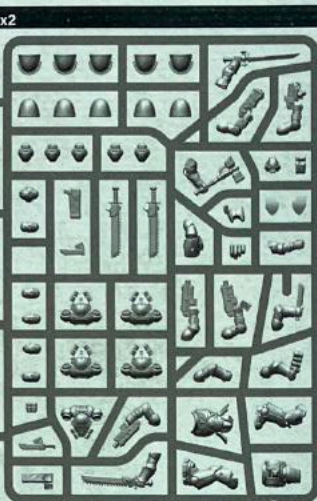
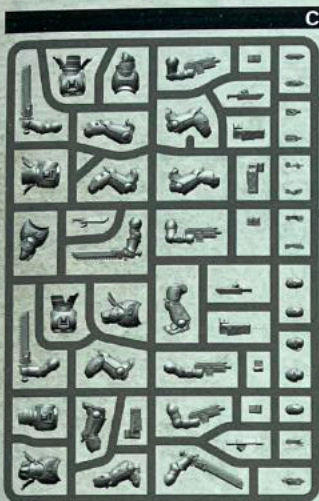

1 a

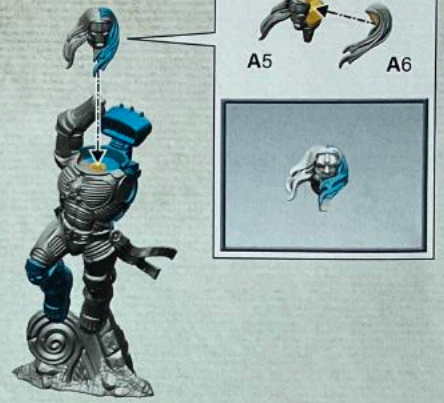
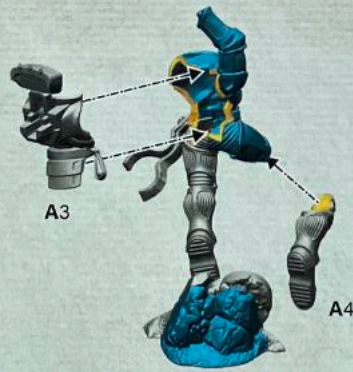
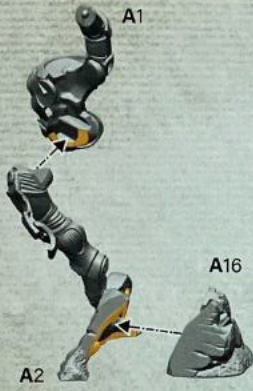

1 b

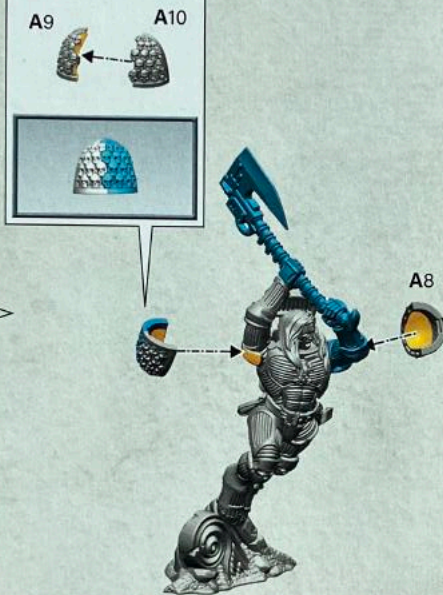

2

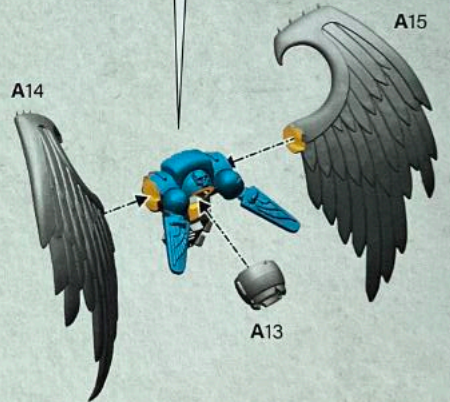
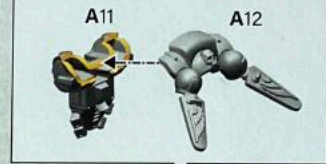

3



4 a

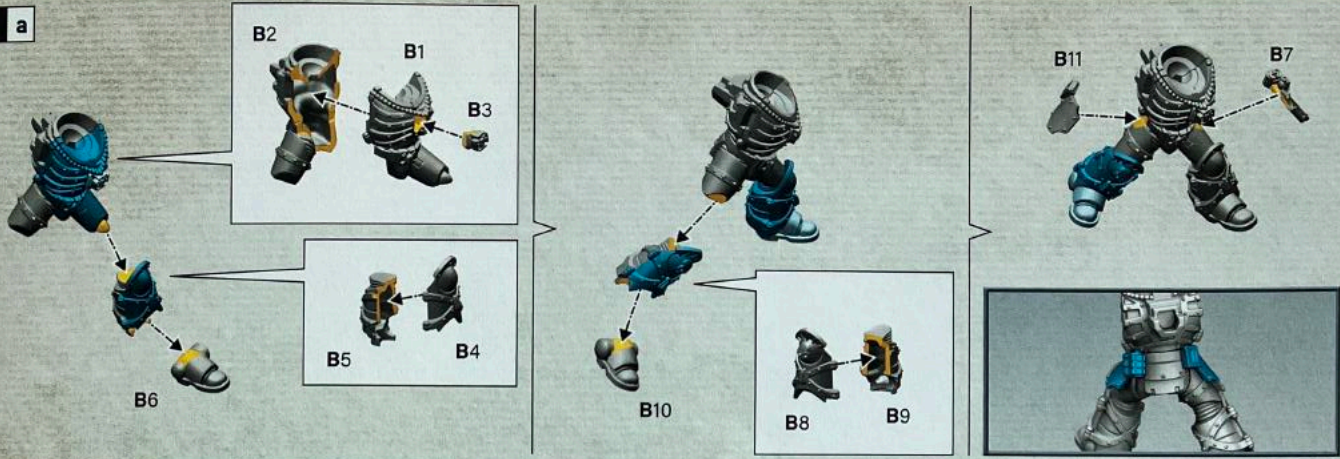

4 b

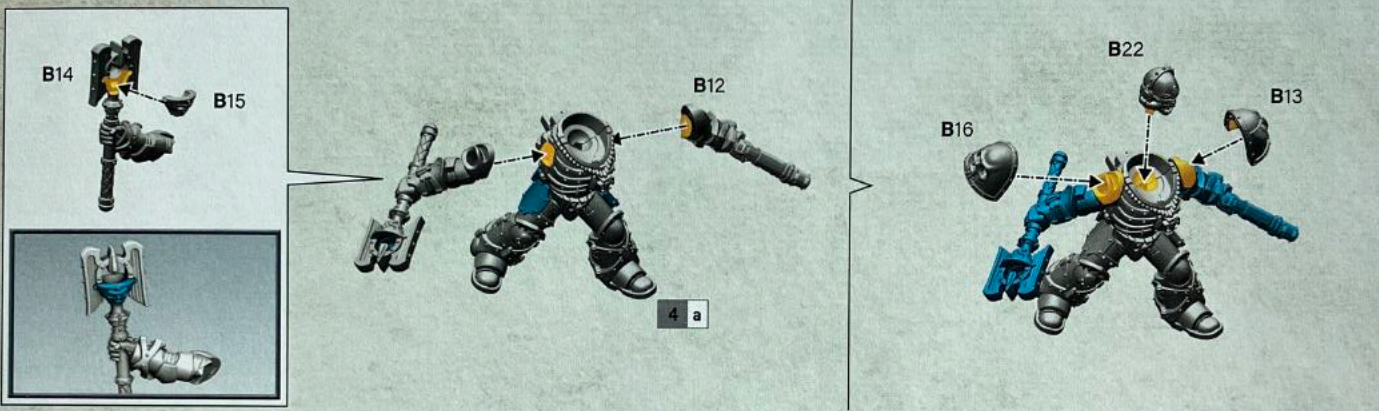

5

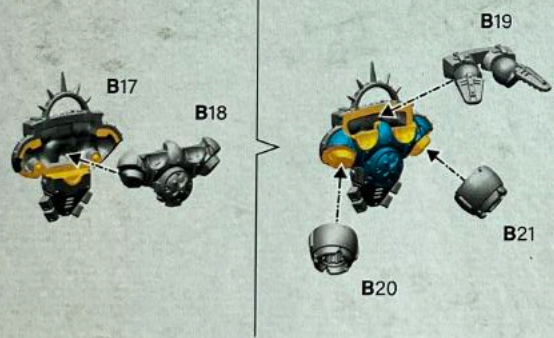

6

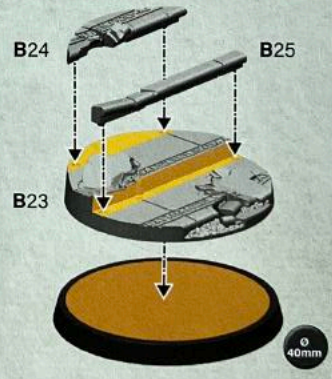

7



CITADEL COLOUR



8 a

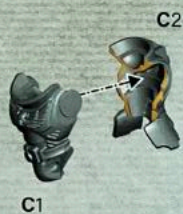

C1

C2



C3

C4



C33

ø 32mm



8 b

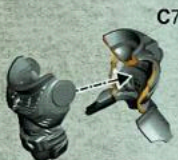

C8

C7



C10

C9

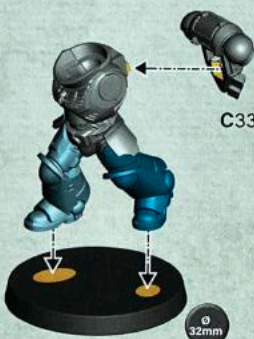

C33

ø 32mm



8 c



C13

C14

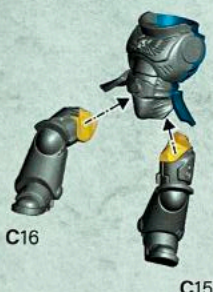

C16

C15

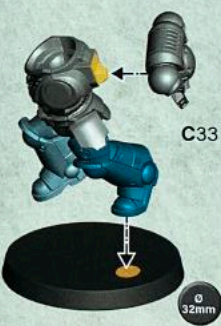

C33

ø 32mm



8 d

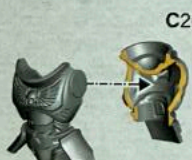

C19

C20

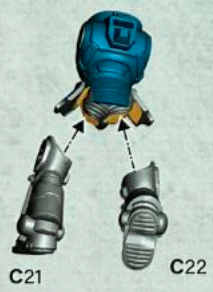

C21

C22



C33

ø 32mm



8 e



C25

C26

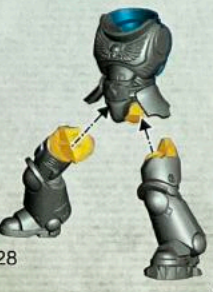

C28

C27



C33

ø 32mm



- 9**
- Choose the variant you want to build
 - Choisissez la variante à assembler
 - Elige qué versión quieres montar

- Wähle die Variante, die du bauen möchtest
- Scegli la variante che vuoi assemblare
- 組み立てバリエーションの選択
- 选择你喜欢的拼装方式

9 a ≤1



9 b ≤4



9 c ≤1



9 d ≤1



9 e ≤1



9 f ≤1



9 a

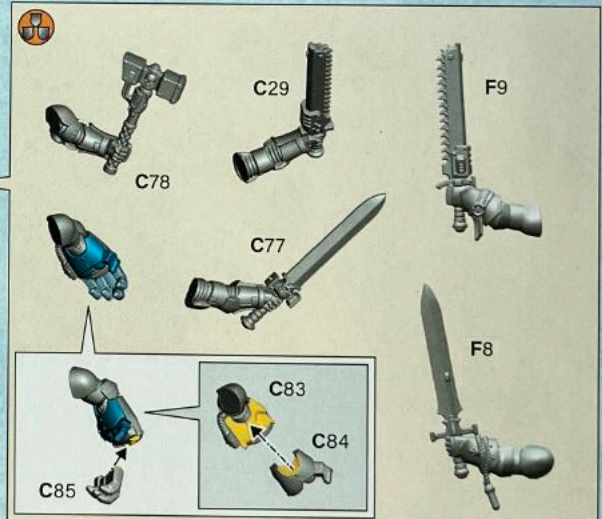
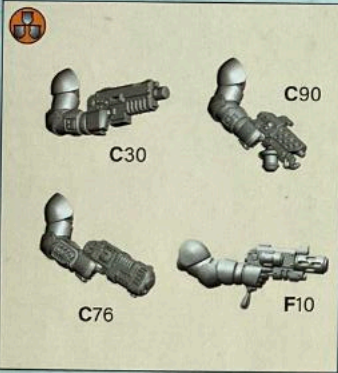

9 b

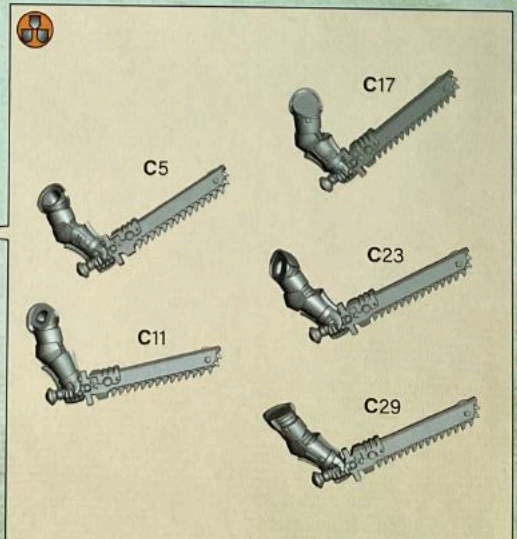
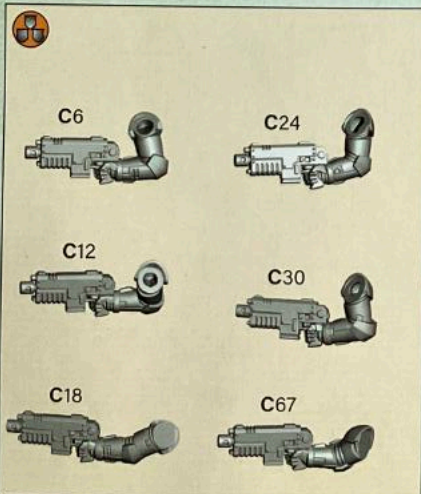

9 c

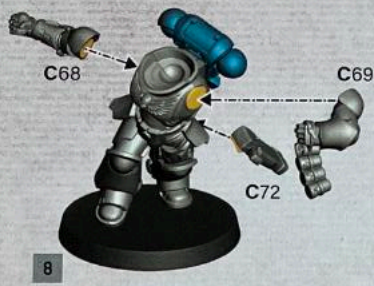

8

9 d



8

9 e



8

9 f

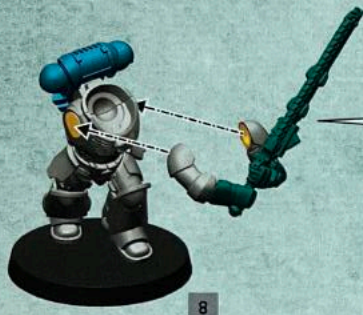

8

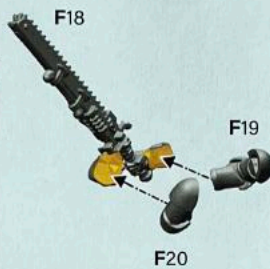

10 a x5

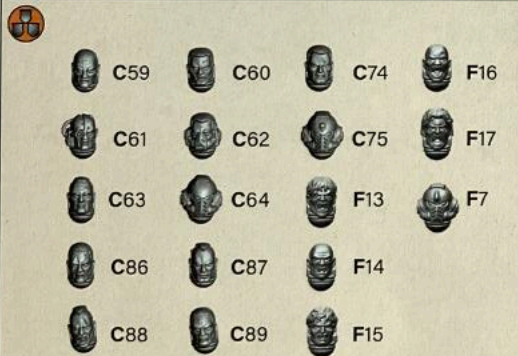

9



10 b x5

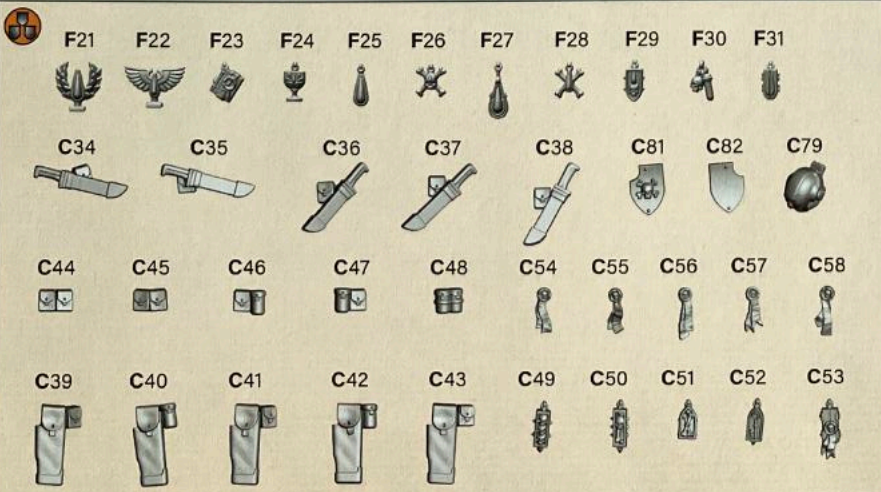

9 a



CITADEL
COLOUR





- Interchangeable Parts
- Éléments Interchangeables
- Partes Intercambiables

- Austauschbare Teile
- Componenti Intercambiabili
- 組み換え可能な部品

- 可互换零件

11



12

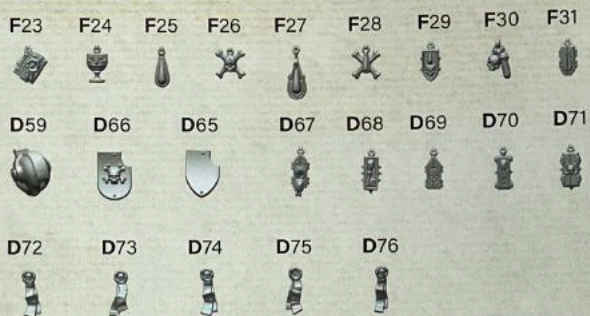

13 x5

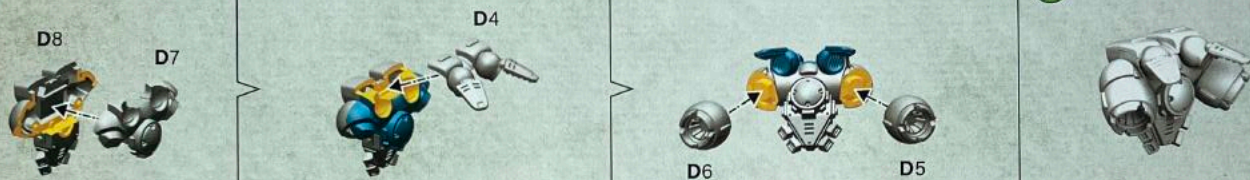

14 a

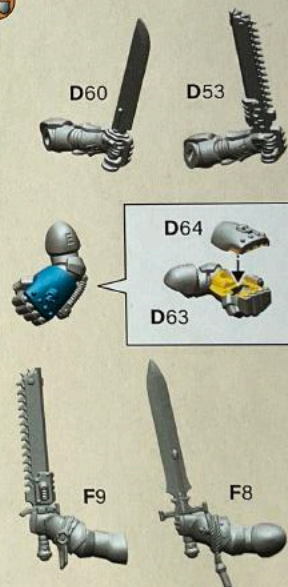

14 b

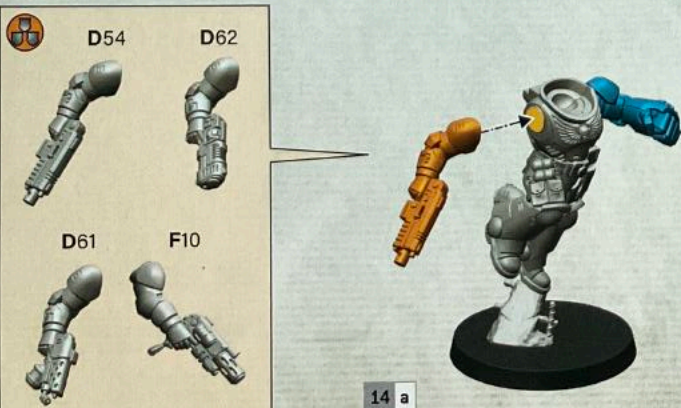

14 c



15 a

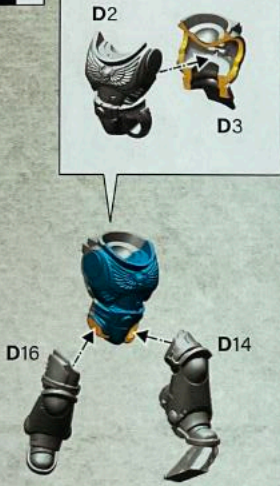

! 15 b



15 c



15 b



15 c

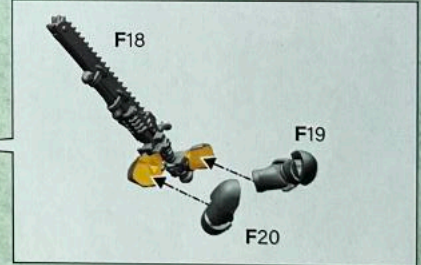

15 d



16 a

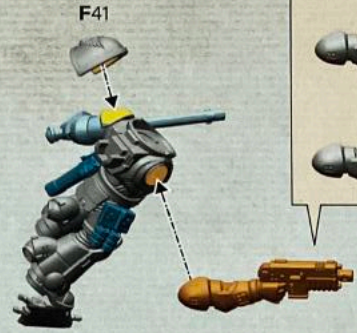
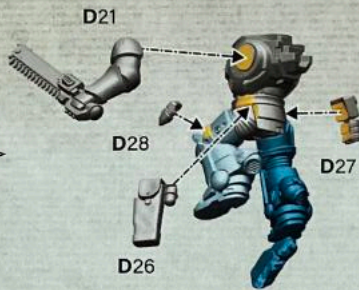

16 b

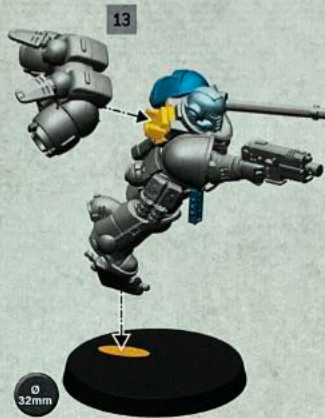

17 a

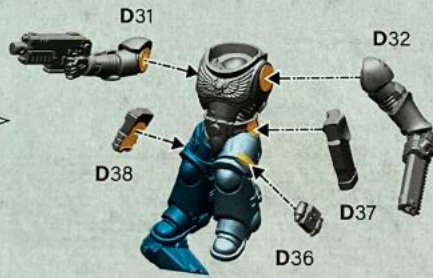
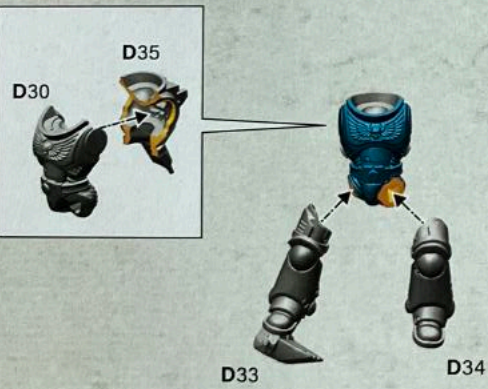

17 b



18 a

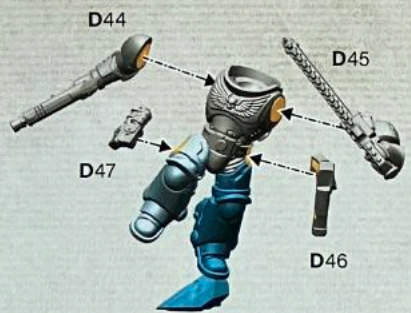

18 b

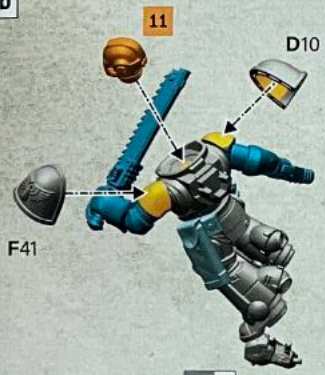

CITADEL COLOUR



19 a

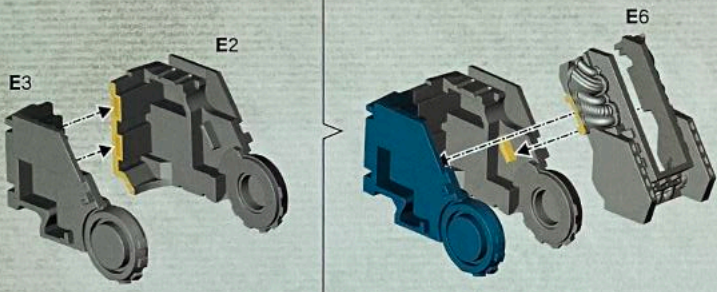

E17 E18

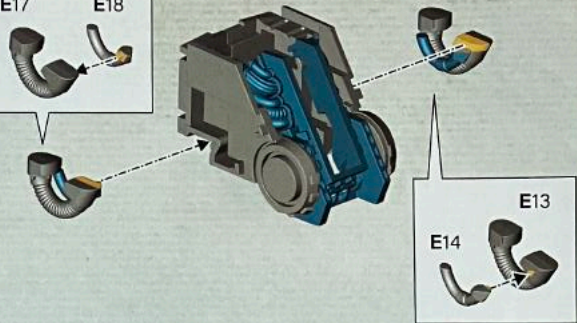

19 b

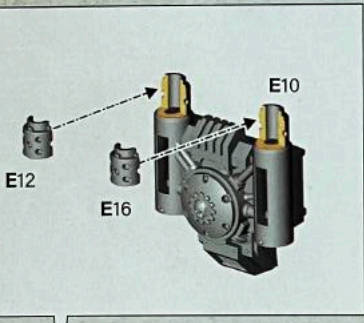

19 c

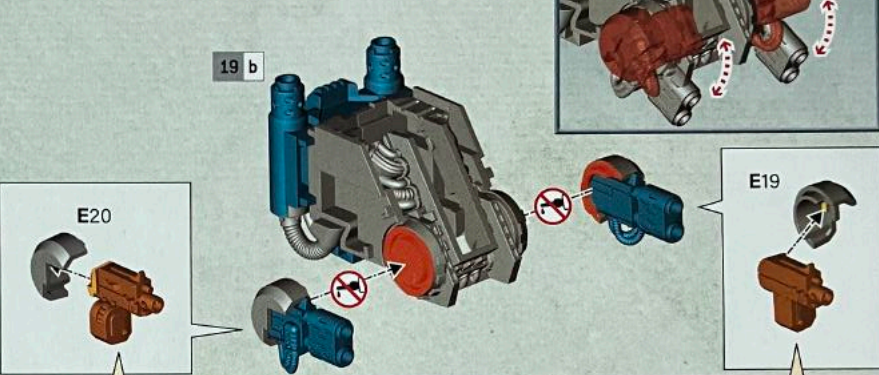

19 d

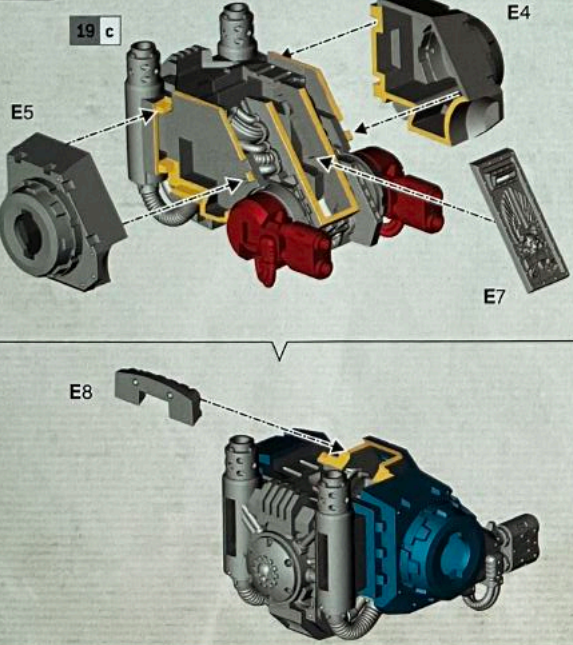

19 e

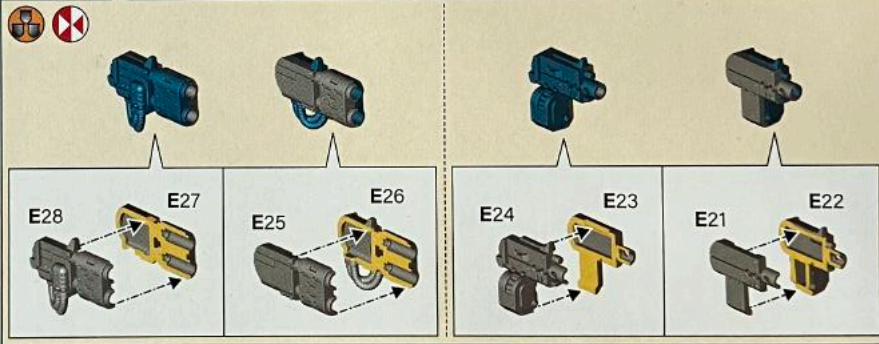
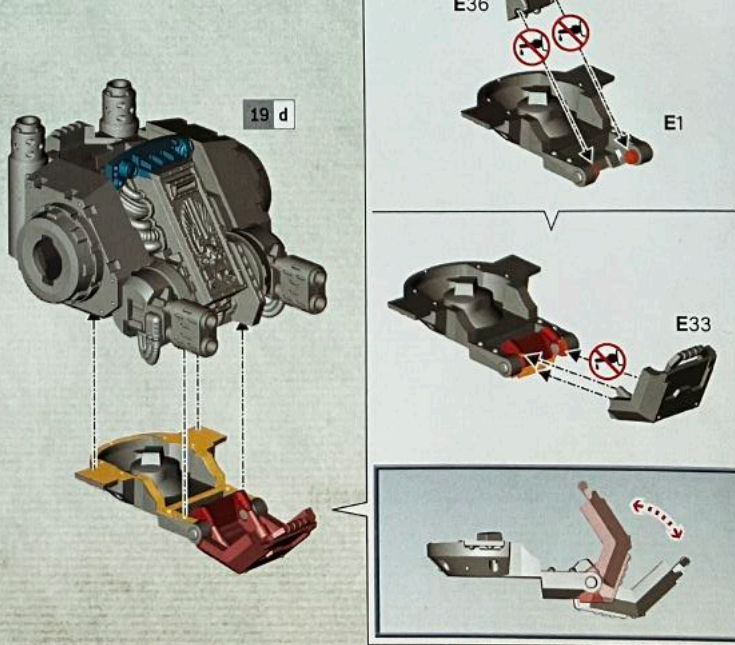

19 f

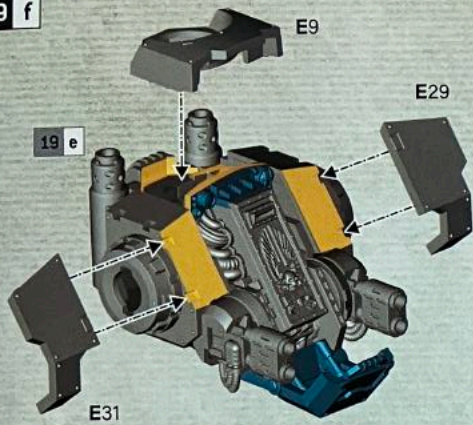

E32 E29

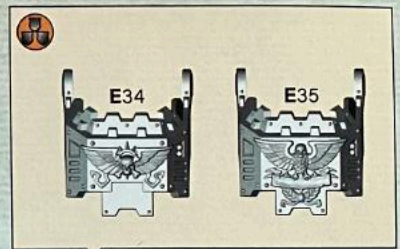
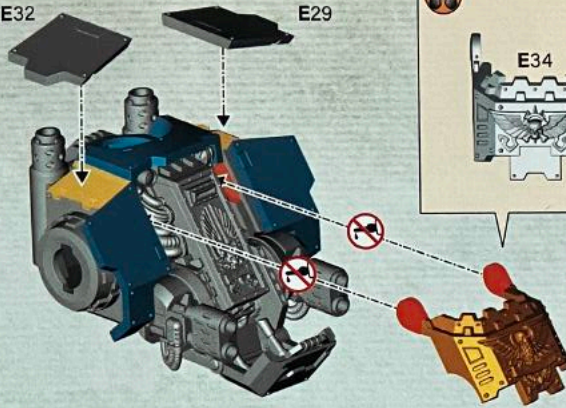

19 g

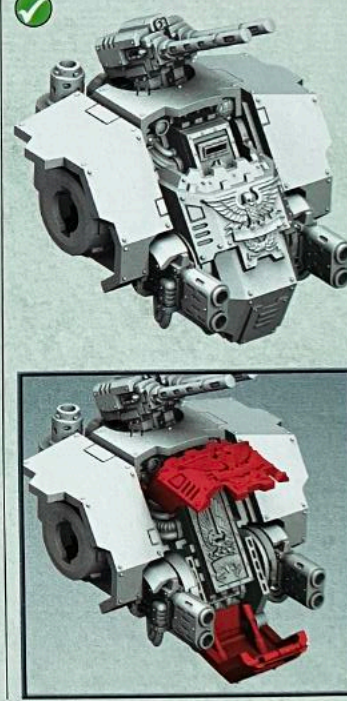
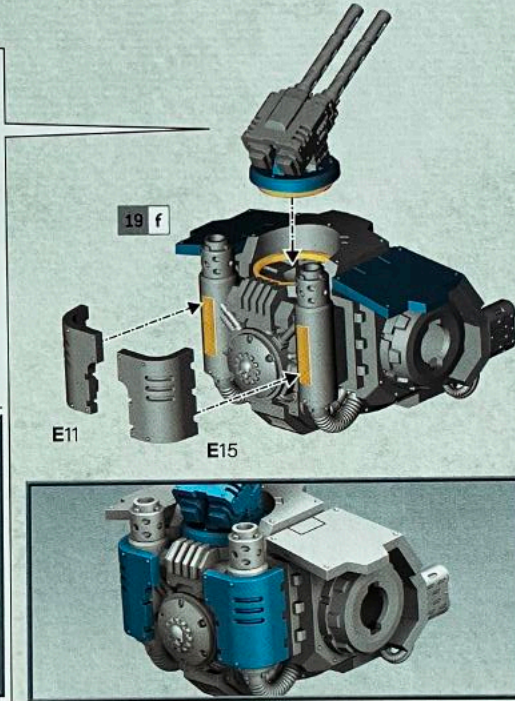
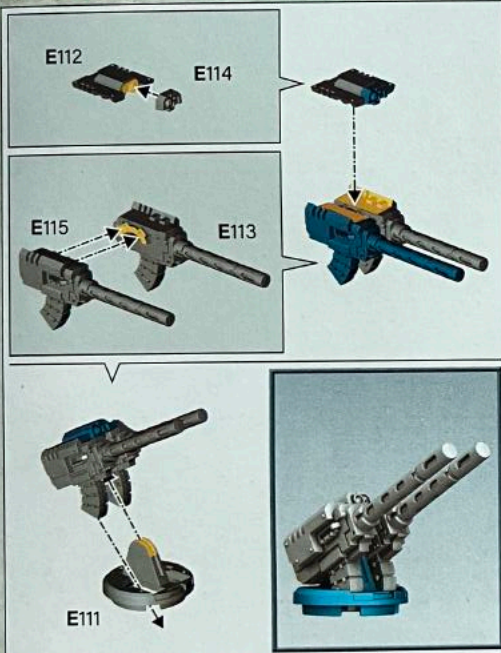

20

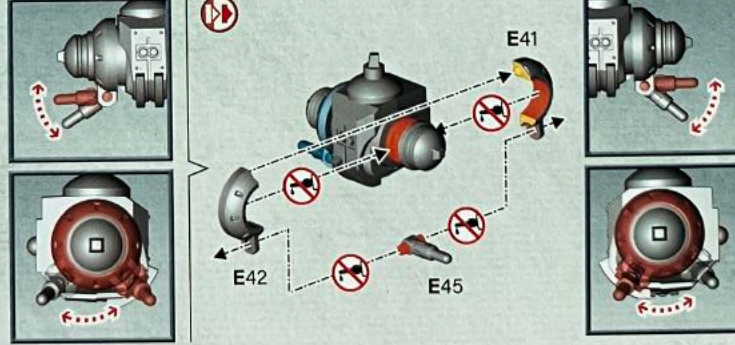
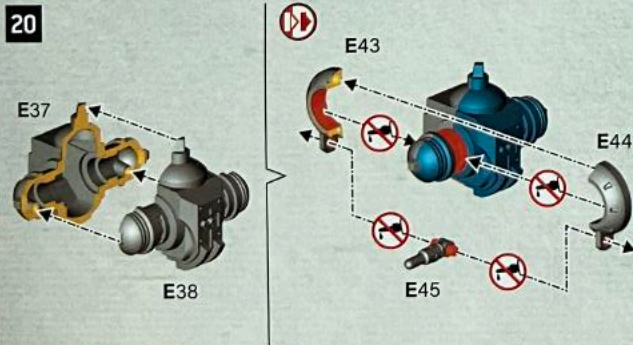

21-23

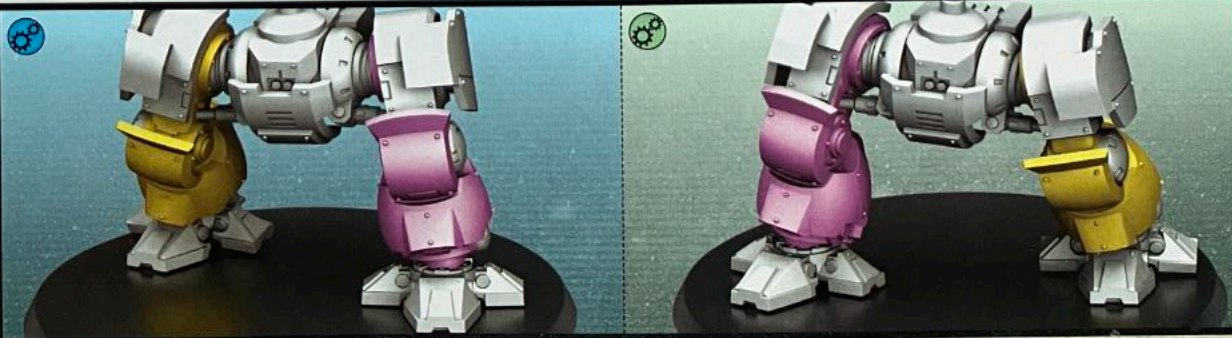

21 a

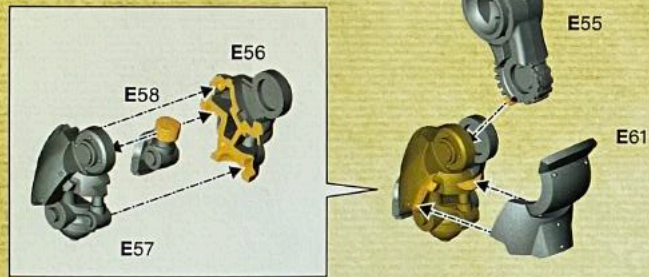

21 b

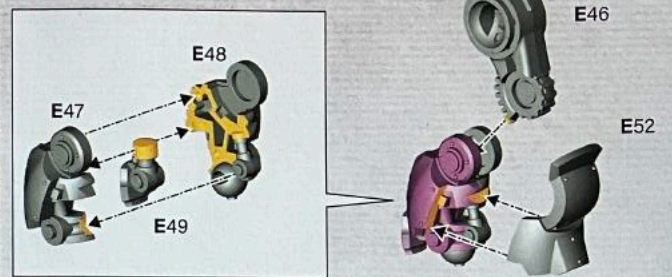

22 a

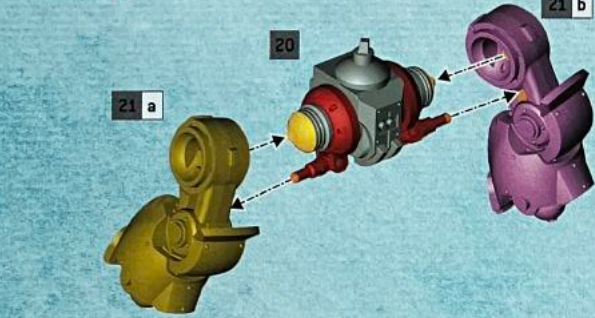

22 b

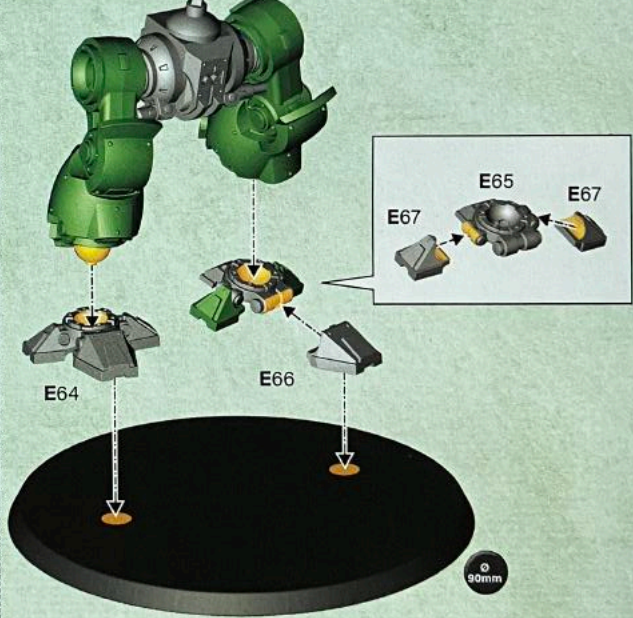
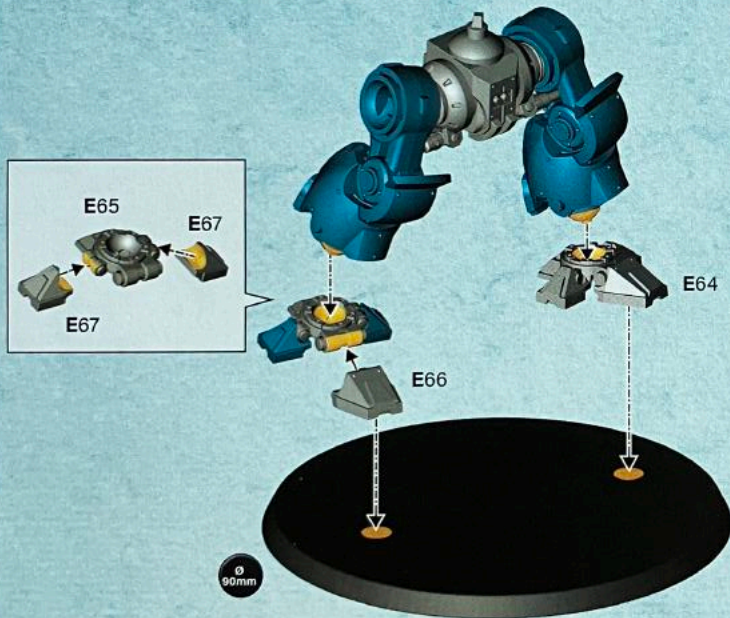
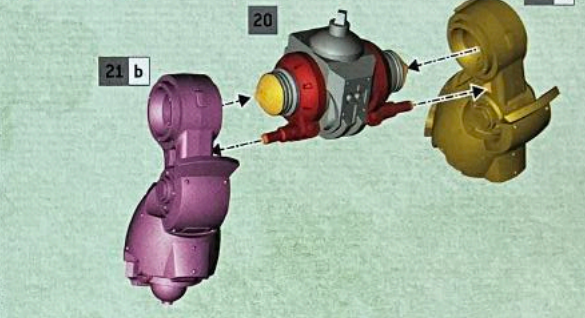

23

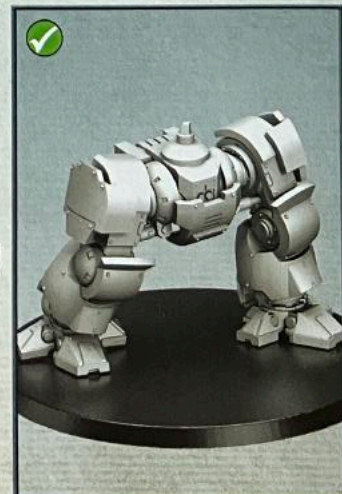
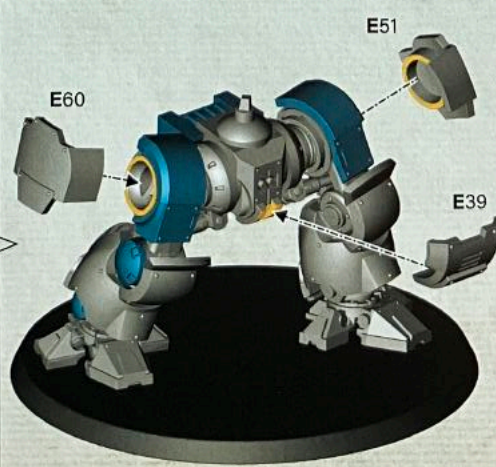
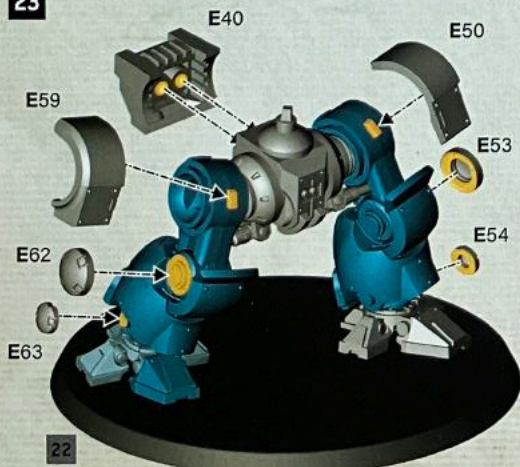

24

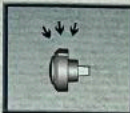
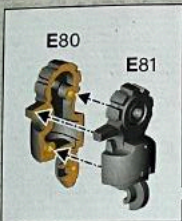

E82 E83

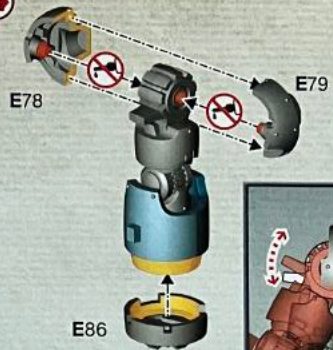
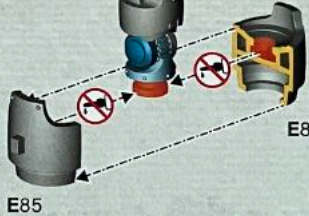

E86

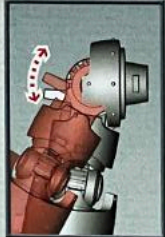

25

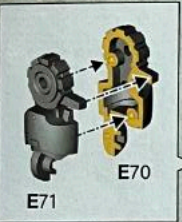

E73 E72

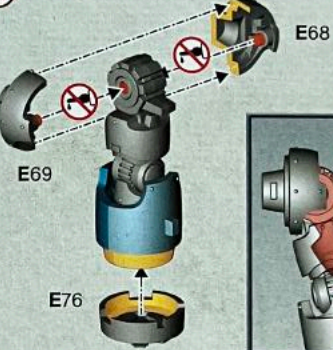
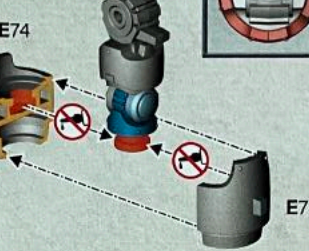

E76



26

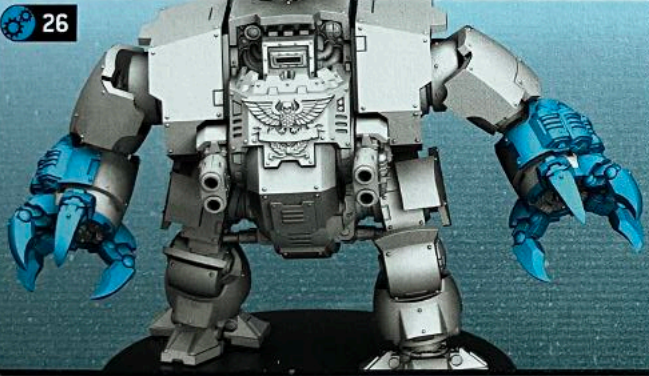

27

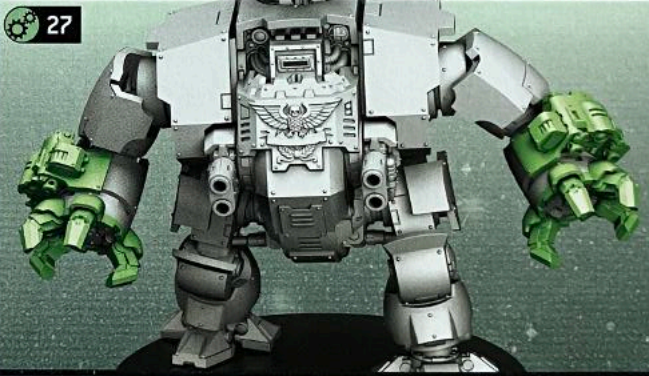

26 a

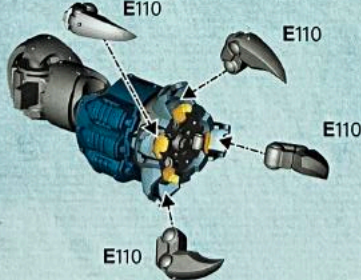
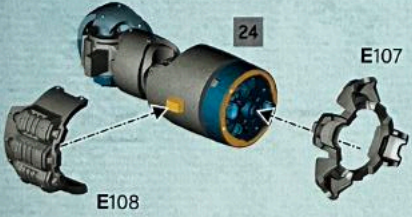

26 b

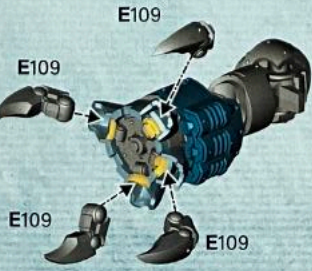
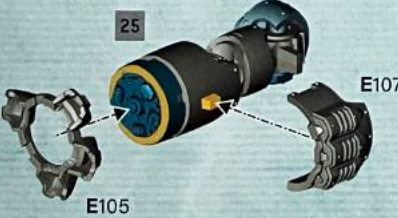

27 a

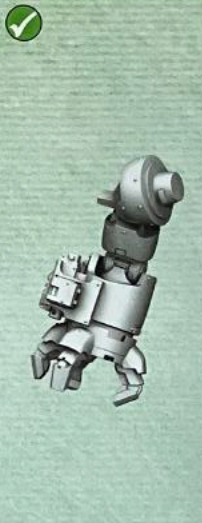
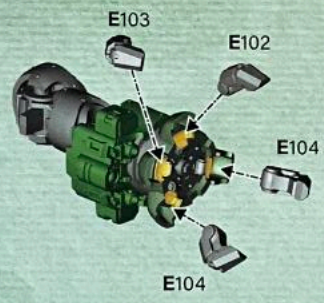
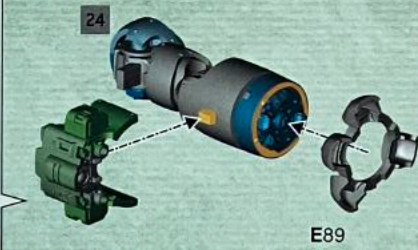
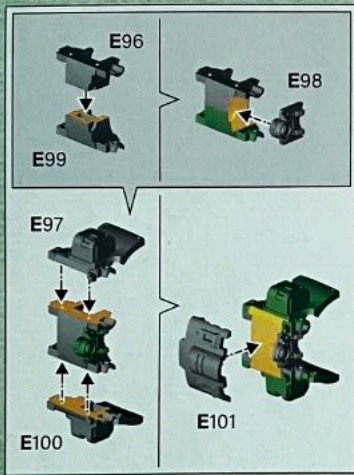

27 b

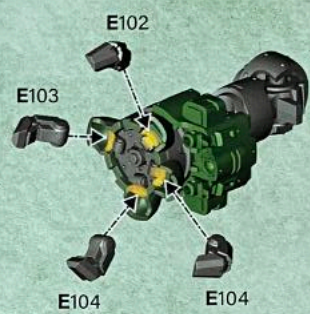
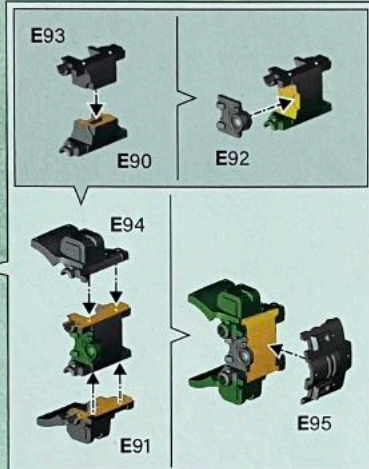
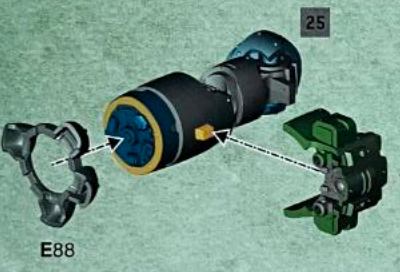

28 a

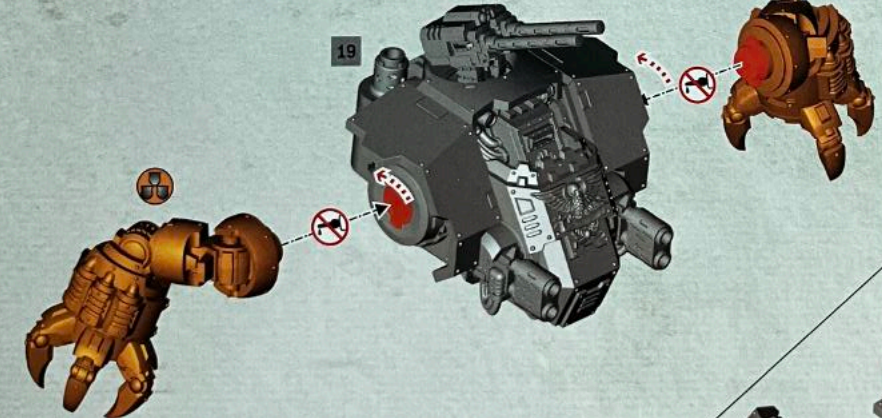

28 b

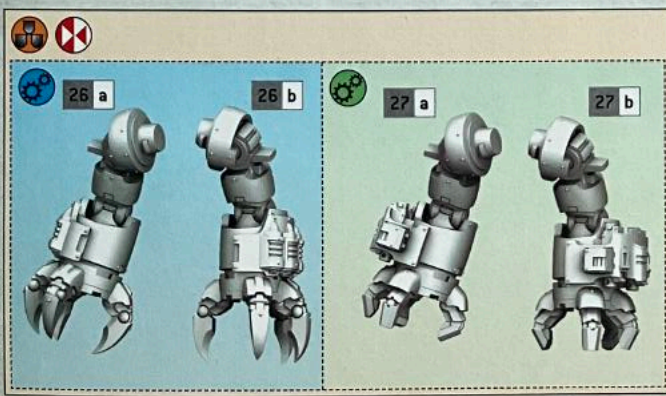
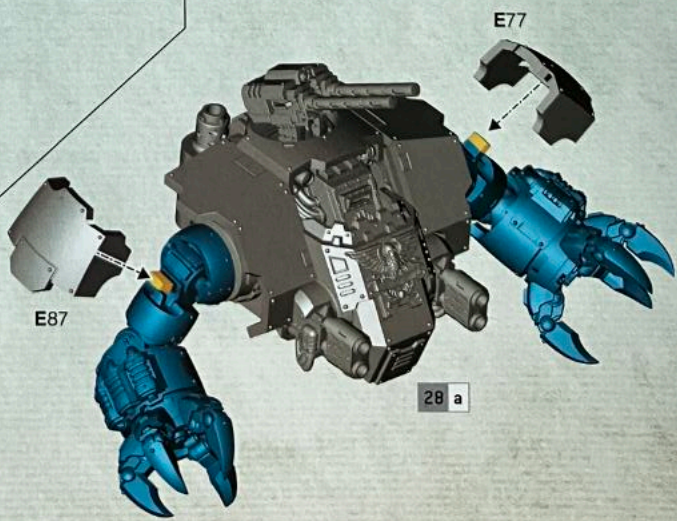

28 c

28 b

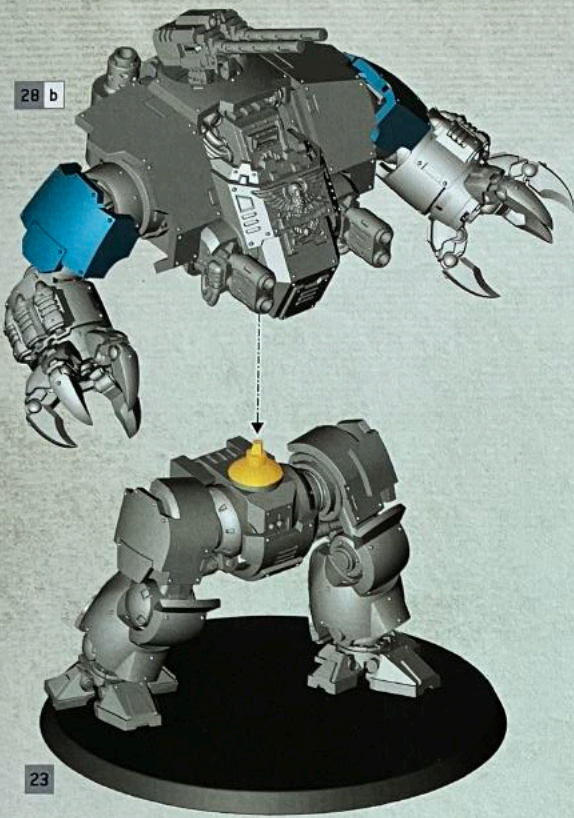

23

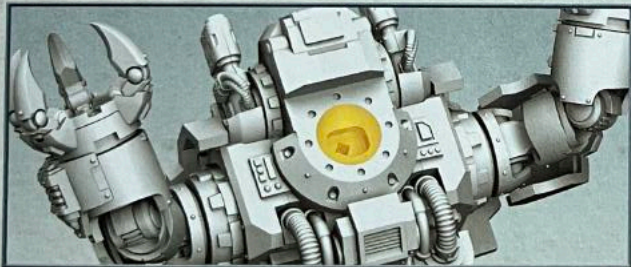

28 a



23

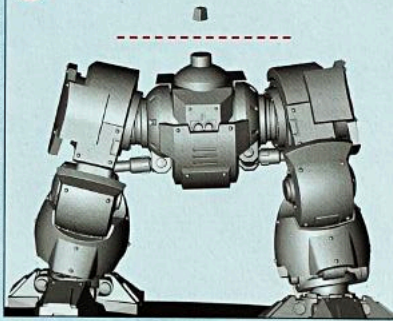

28 d

- | | | | |
|------|------|------|-----|
| | | | |
| E116 | E117 | E118 | |
| | | | |
| F32 | F33 | F34 | F35 |



28 c





ENG More painting guides can be found on citadelcolour.com

FRE D'autres guides de peinture sont disponibles citadelcolour.com

SPA Encontrarás más guías de pintura en citadelcolour.com

GER Weitere Bemalanleitungen auf citadelcolour.com

ITA Puoi trovare altre guide alla pittura su citadelcolour.com

日本語 citadelcolour.com には他にも様々なペイントガイドが掲載されている

中文 更多涂装指南请至 citadelcolour.com



WARHAMMER.COM

Games Workshop Limited, Willow Road, Nottingham, NG7 2WS, UK

© Copyright Games Workshop Limited 2024.

