



Free Downloads of Build Instructions,  
Assembly Booklets & How To Guides

**BuildInstructions.com**

# WARHAMMER 40,000

## BATTLEZONE: FRONTERIS NACHMUND

ナハムンド | 纳克蒙德



**!** READ THIS FIRST | À LIRE EN PRIORITÉ | BITTE BEACHTE | LEE ESTO PRIMERO | LEGGI PRIMA QUESTO | 最初にお読みください。| 请优先阅读

**ENG** BEFORE ASSEMBLING YOUR MINIATURES, PLEASE READ THROUGH THE INSTRUCTIONS IN THIS BOOKLET CAREFULLY. A pair of plastic cutters is required to remove the plastic components in this kit from their frame. We advise using a mouldline scraping tool to clean up the parts. To assemble your model you will need plastic glue. Games Workshop sells Citadel Fine Detail Cutters, Citadel Mouldline Remover and Citadel Plastic Glue, but does not recommend these products for use by children under the age of 16 without adult supervision.

**FRE** AVANT D'ASSEMBLER VOS FIGURINES, VEUILLEZ LIRE ATTENTIVEMENT LES INSTRUCTIONS DE CE LIVRET. Une pince coupante est requise pour détacher chaque élément de sa grappe. Nous vous recommandons l'utilisation d'un grattoir pour ébarber les éléments. Pour l'assemblage, vous aurez également besoin de colle plastique. Games Workshop commercialise les Pinces de Précision Citadel, l'Ébarboir Citadel et la Colle Plastique Citadel, mais n'en recommande pas l'utilisation pour des enfants de moins de 16 ans sans la supervision d'un adulte.

**ESP** POR FAVOR, LEE CUIDADOSAMENTE ESTE LIBRETO DE INSTRUCCIONES ANTES DE EMPEZAR A MONTAR LAS MINIATURAS. Te harán falta unas tenazas para plástico a fin de separar las piezas de la matriz. También aconsejamos una herramienta para rebabas a fin de limpiar cada pieza. Para montar la miniatura necesitarás pegamento para plástico. Games Workshop vende Tenazas Citadel, Herramientas para rebabas Citadel y Pegamento para plástico Citadel, pero no recomienda estos productos a menores de 16 años sin la supervisión de un adulto.

**GER** VOR DEM ZUSAMMENBAU DER MINIATUREN BITTE DIE ANWEISUNGEN IN DIESER ANLEITUNG AUFMERKSAM DURCHLESEN. Du benötigst einen

Kunststoffseitschneider, um die Kunststoffbauteile aus dem Gussrahmen herauszutrennen, und Kunststoffkleber, um die Miniatur zusammenzubauen. Außerdem empfehlen wir, die Bauteile vorher mit einem Gussgratentferner zu säubern. Games Workshop bietet Präzisions-Kunststoffseitschneider von Citadel sowie Citadel-Kunststoffkleber an, empfiehlt aber, dass Kinder unter 16 Jahren diese nur unter Aufsicht eines Erwachsenen benutzen.

**ITA** PRIMA DI ASSEMBLARE LE TUE MINIATURE LEGGI ATTENTAMENTE TUTTE LE ISTRUZIONI DI QUESTO LIBRETTO. Sono necessarie un paio di tronchesine per plastica per staccare i componenti dal loro sprue. Consigliamo di usare un attrezzo apposito per pulire i componenti. Per assemblare il modello avrai bisogno di colla per plastica. Games Workshop vende Tronchesine di precisione Citadel. Attrezzo per ripulire Citadel e Colla per plastica Citadel, ma non consiglia questi prodotti ad un pubblico minore di 16 anni senza la supervisione di un adulto.

**日本** 本キット内のフレームからプラスチックパーツを切り離すためには、ニッパーが必要です。パーツのセールドを平らにするには、専用ツールの使用をお勧めいたします。本キットの組み立てには、ブラ用接着剤が必要です。ゲームズワークショップはシタデル・ニッパー、ブラ用接着剤、シタデル・モールドラインリムーバーを販売しておりますが、16歳以下の子供が大人の監督なしにこれらの道具を使用されることをお勧めしません。

**中文** 你需要一把模型剪将塑料部件从板上剪下来。我们建议使用分模线刮刀来处理零件。组装时你还需要用到模型胶水。你可以从 Games Workshop 处购买到 Citadel Fine Detail Cutter 模型剪、Citadel Mouldline Remover 分模线刮刀和 Citadel Plastic Glue 模型胶。但 16 岁以下儿童不得在没有成年人监护的情况下使用这些产品。

EXPLANATION OF SYMBOLS | EXPLICATION DES SYMBOLES | EXPLICACIÓN DE SÍMBOLOS | ERLÄUTERUNG DER SYMBOLE | LEGENDA DEI SIMBOLI | アイコン解説 | 符号说明

- !** • Special instruction - Please read
- Instructions spéciales - Lire attentivement
- Instrucción especial: Por favor, léela
- Besondere Anweisung - Bitte lesen
- Istruzioni speciali - Leggi attentamente
- 特記事項 - 必ずお読みください
- 特殊说明 - 请详阅

- ⚙️** • Variant assembly
- Variante d'assemblage
- Variante de montaje
- Bauvariante
- Assemblaggio alternativo
- 組み立てバリエーション
- 多种组装方式

- 📦** • Choice of parts
- Choix d'éléments
- Modelos de componentes
- Auswahl an Teilen
- Scelta di componenti
- パーツの選択
- 选择部件

- 🚫** • Do not glue the components
- Ne pas coller les éléments
- No pegar los componentes
- Bitte die Teile nicht kleben
- Non incollare i componenti
- このパーツは接着不可
- 请勿粘接

X4

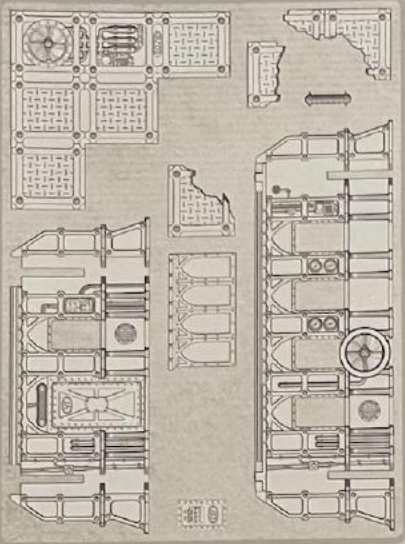

C  
x2

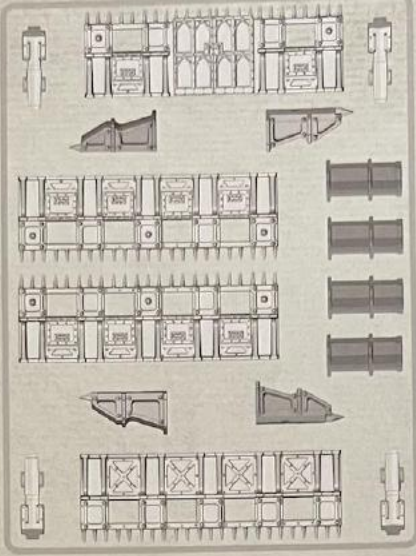

D

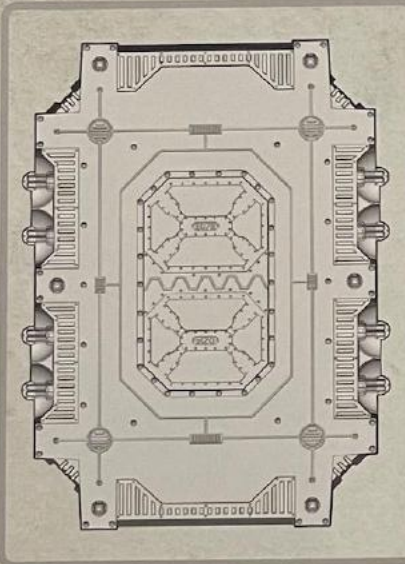

E

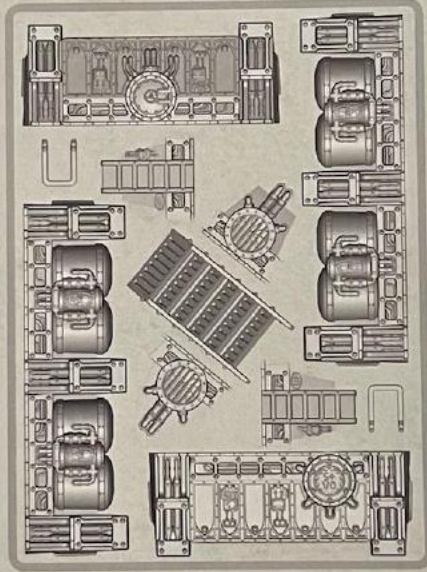

A

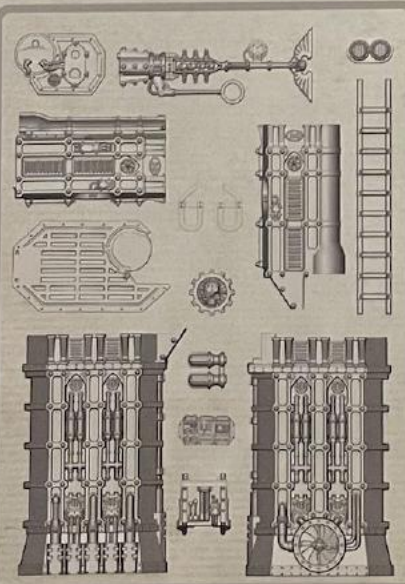

B

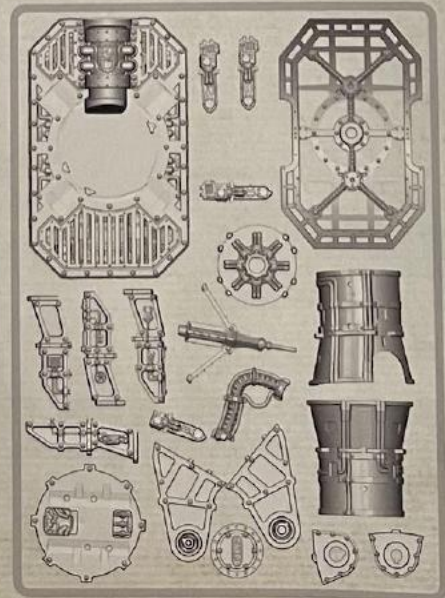

1 STC Hab-Bunker | SCS d'Hab-bunker | Bunker de PCE | STK-Habbunker | SPM Bunker Abitativo | STC居住バンカー | 标准建造模版 生存堡

1 a x2

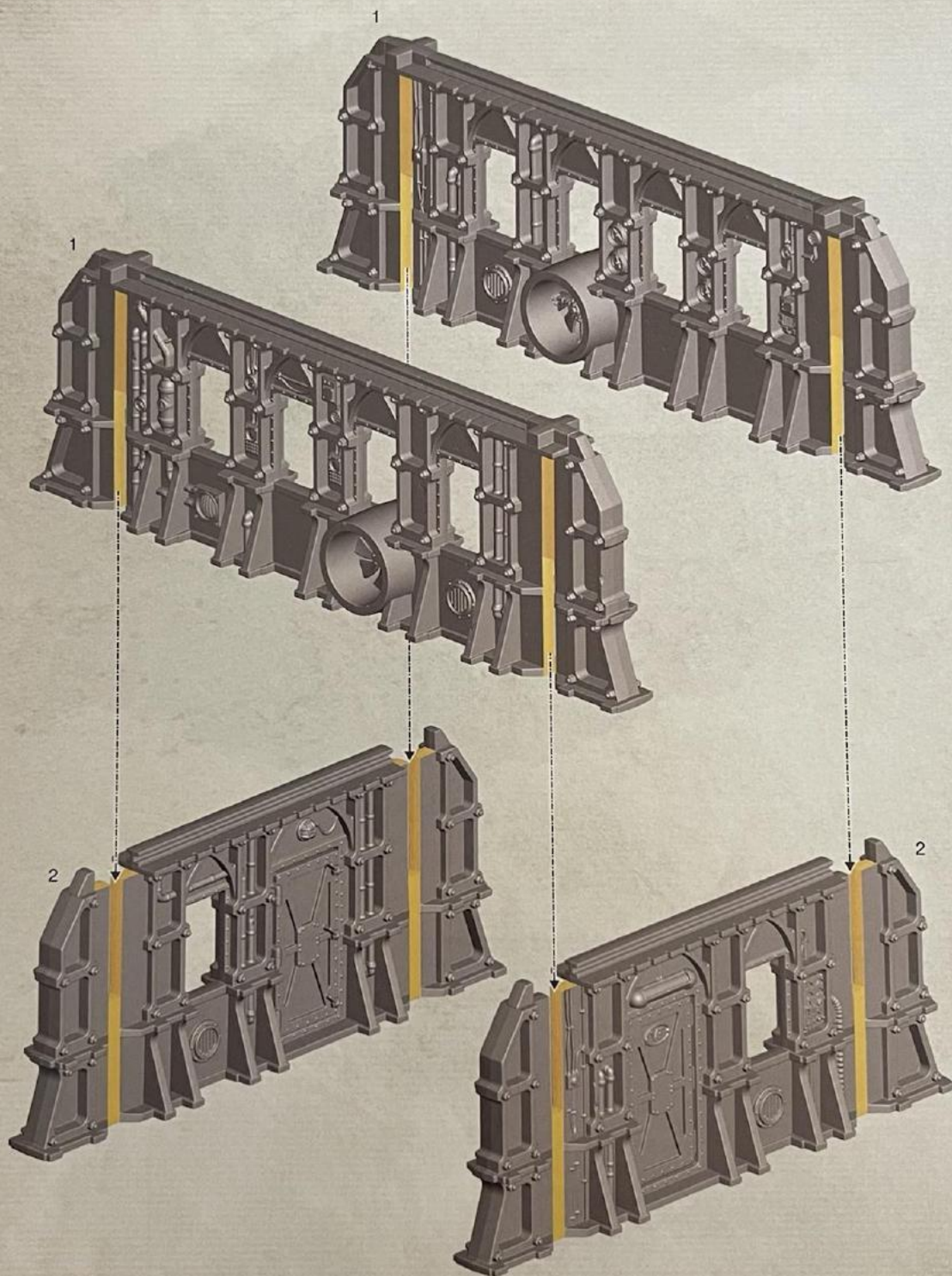

1 b x2

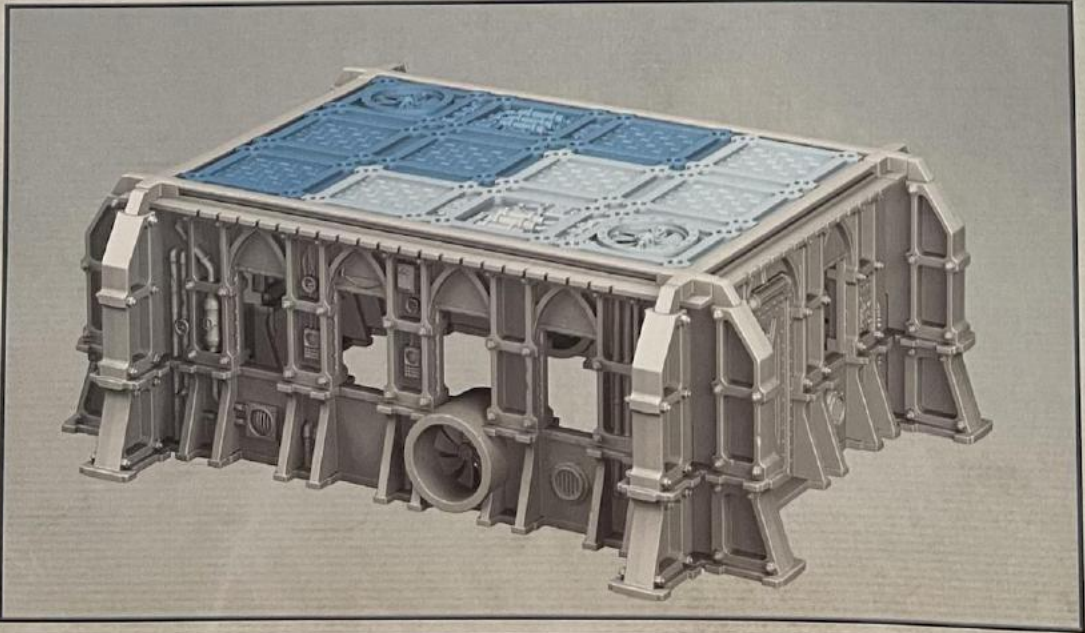
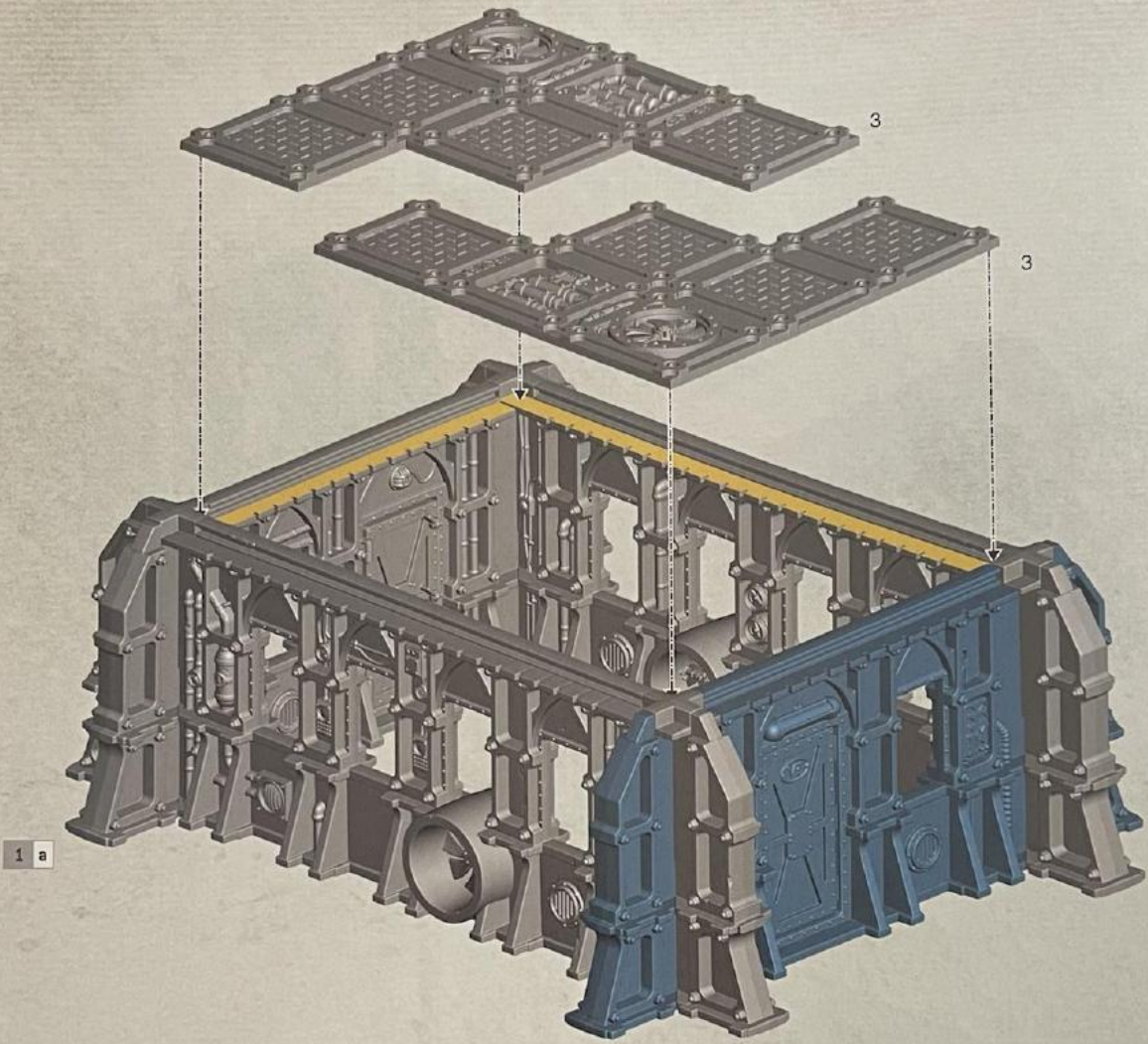

1 c x2

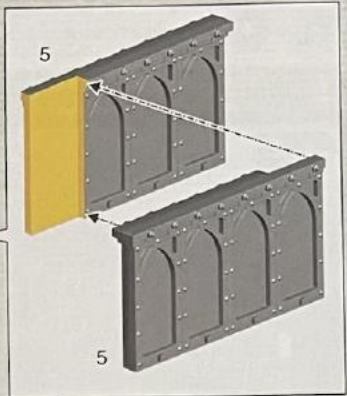
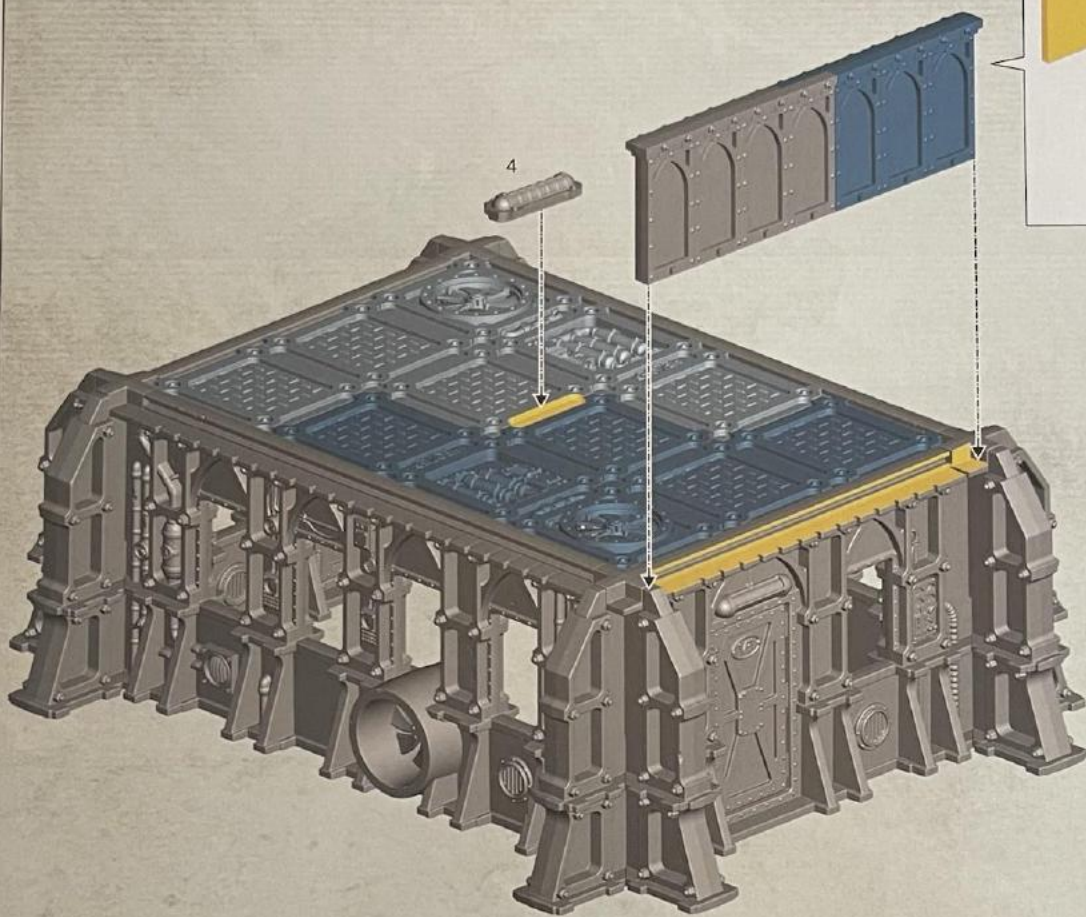

1 b

✓ x2

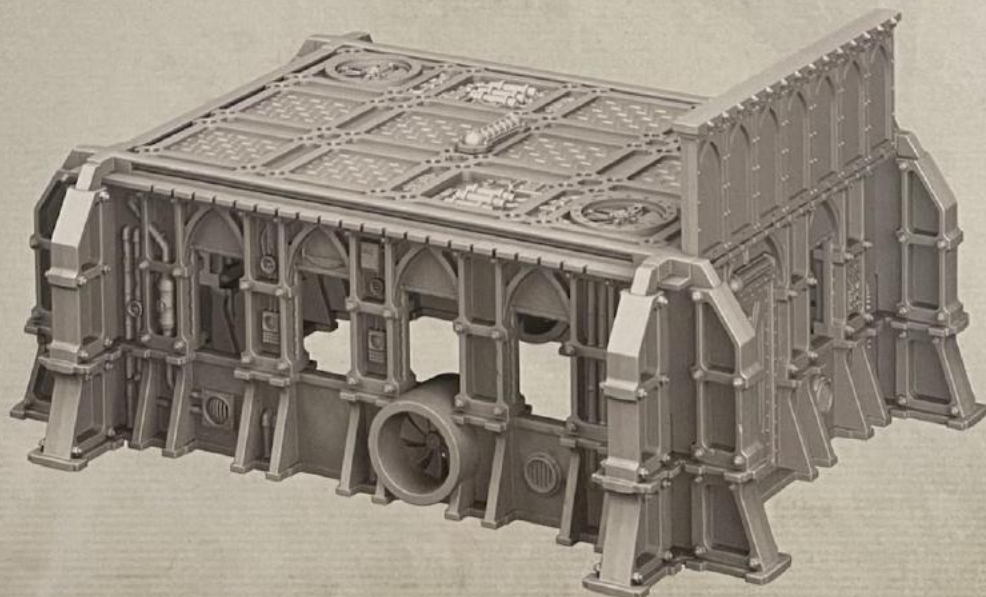

- Choose the variant you want to build
- Choisissez la variante à assembler
- Elige qué versión quieres montar
- Wähle die Variante, die du bauen möchtest
- Scegli la variante che vuoi assemblare
- 組み立てバリエーションの選択
- 选择你喜欢的拼装方式

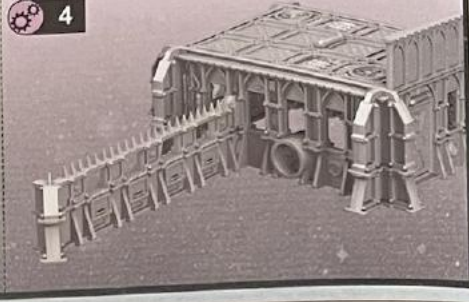
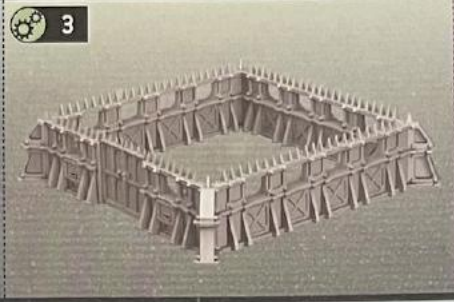
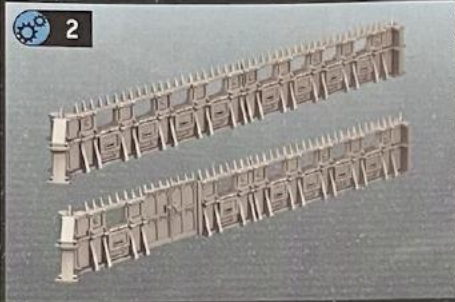

**2 a x8**

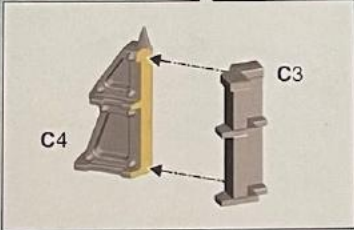
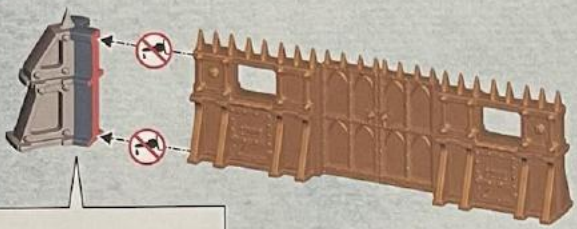

**C1 X2**

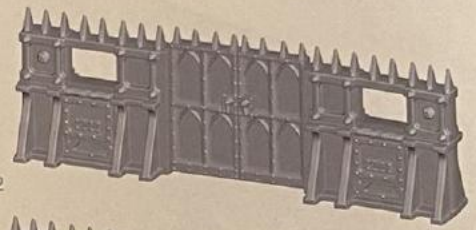

**C2 X6**

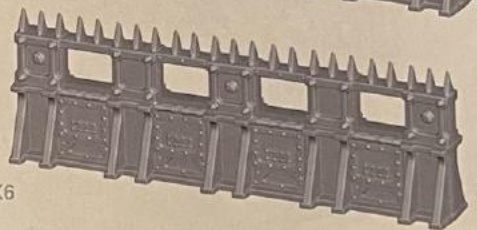

**2 b x4**

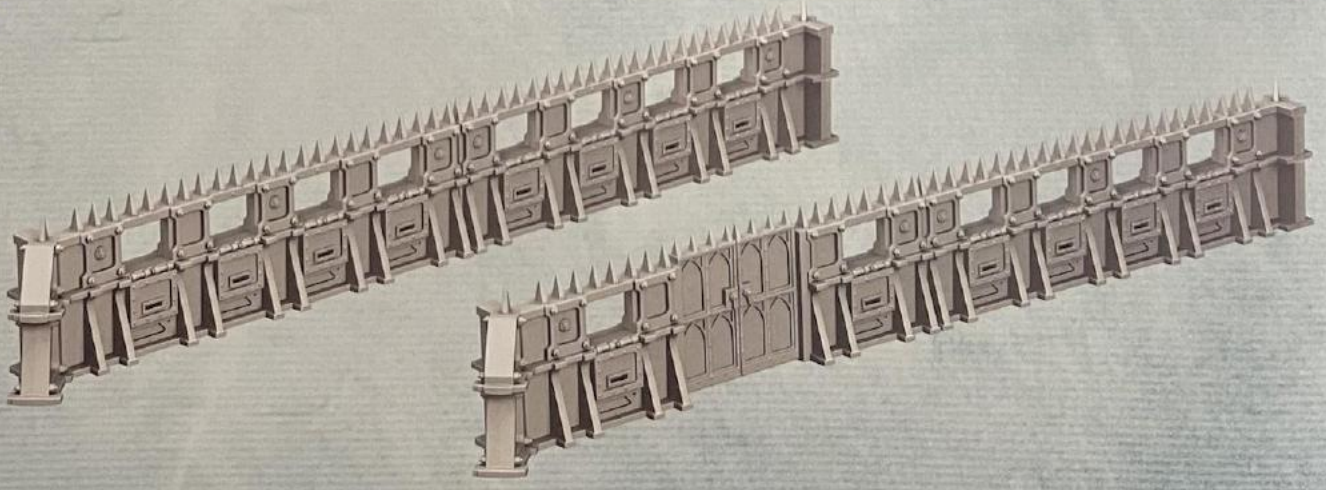

3 a x8

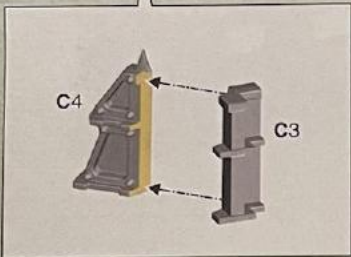
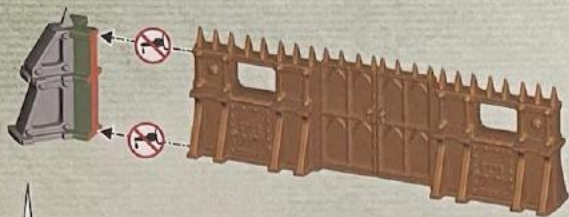

C1 X2

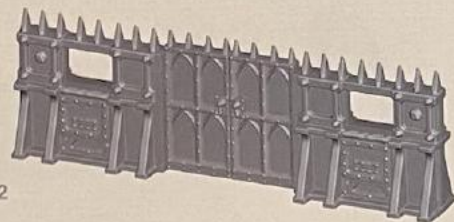

C2 X6

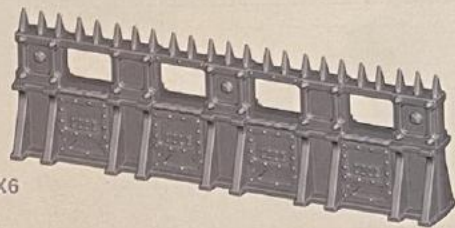

3 b x2

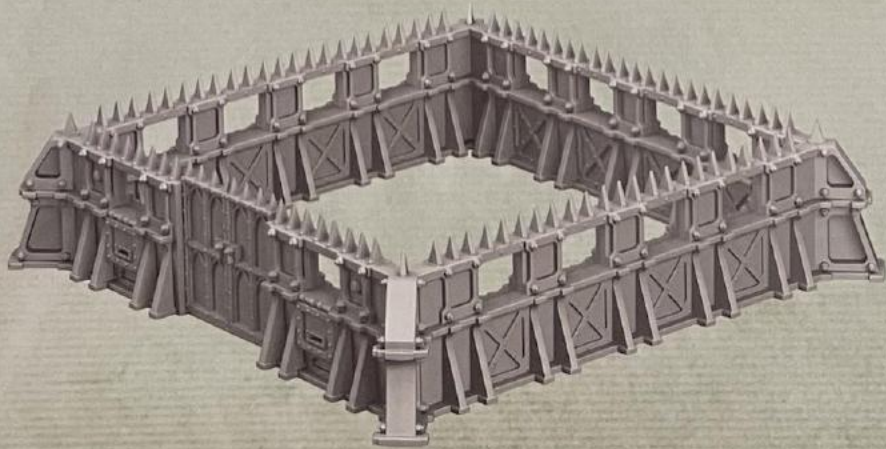
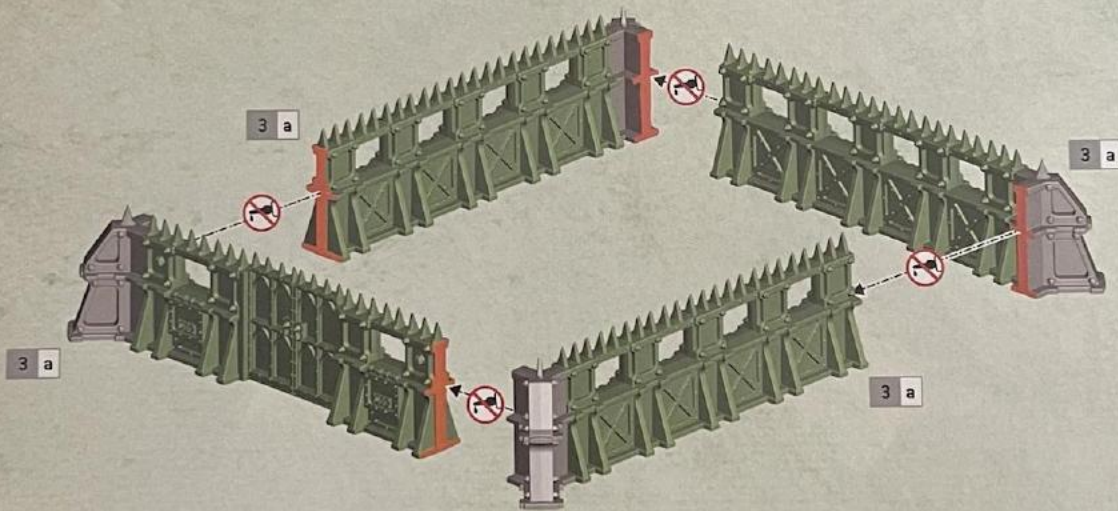



4 a

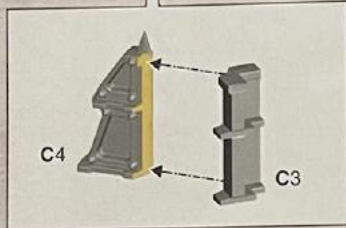

C1 X2

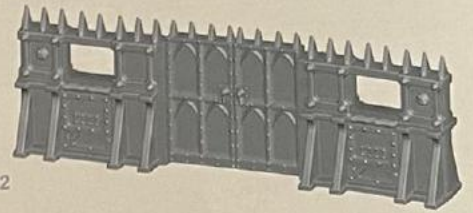

C2 X6

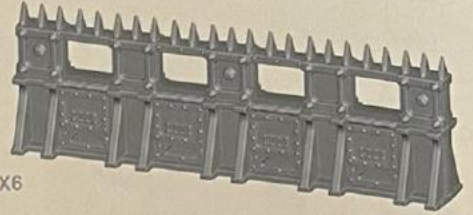

4 b

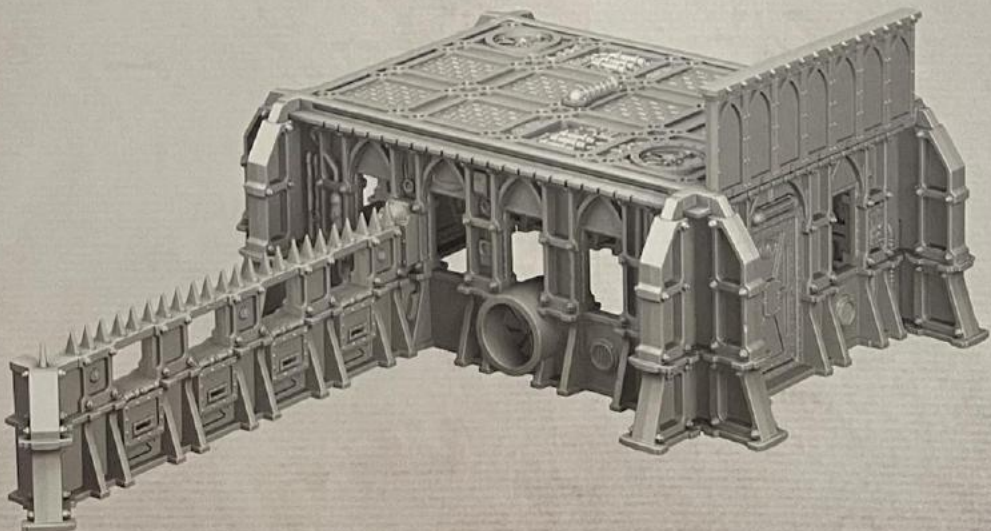
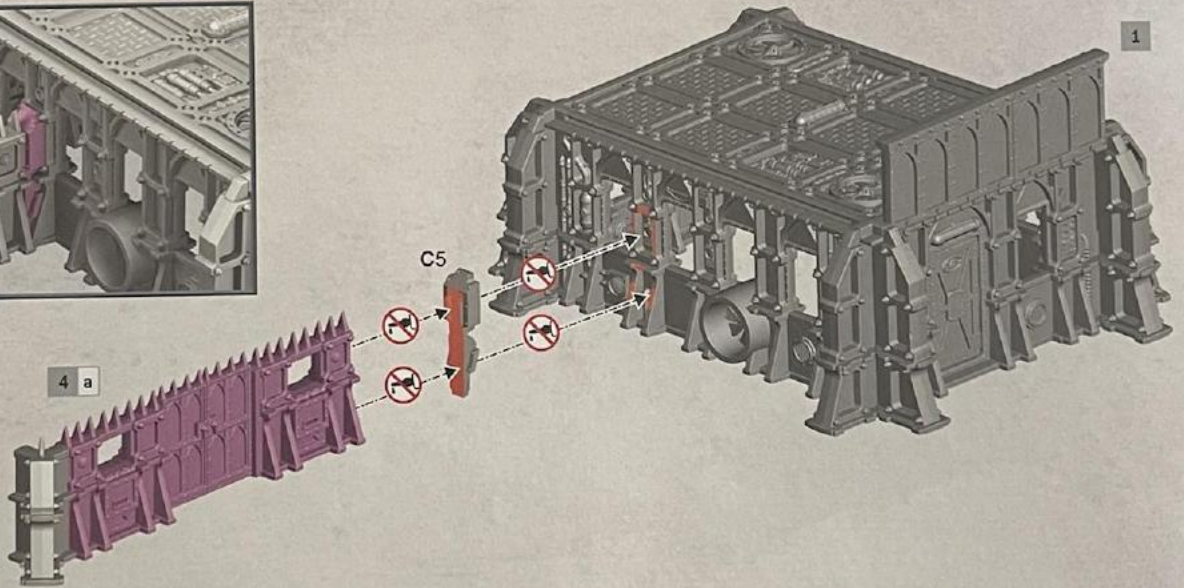
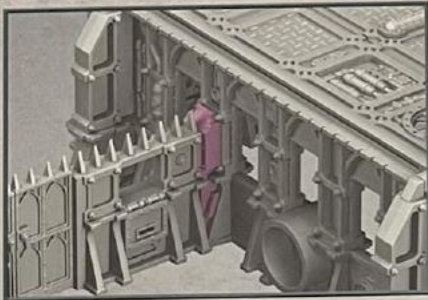

5 a

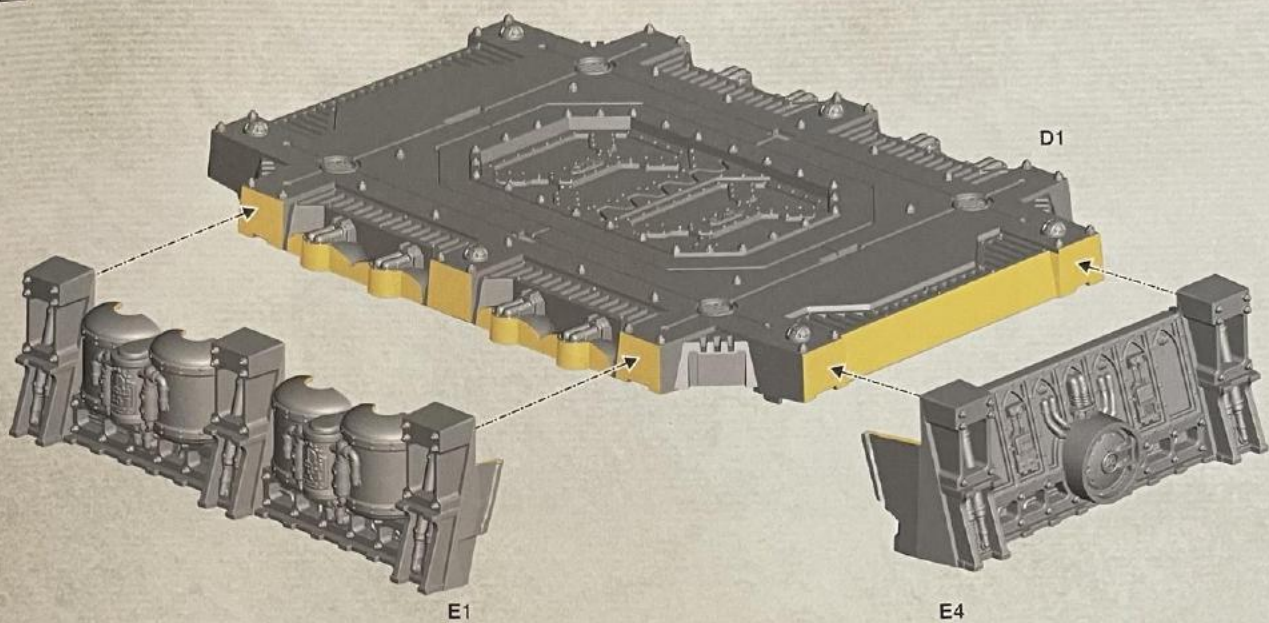

5 b

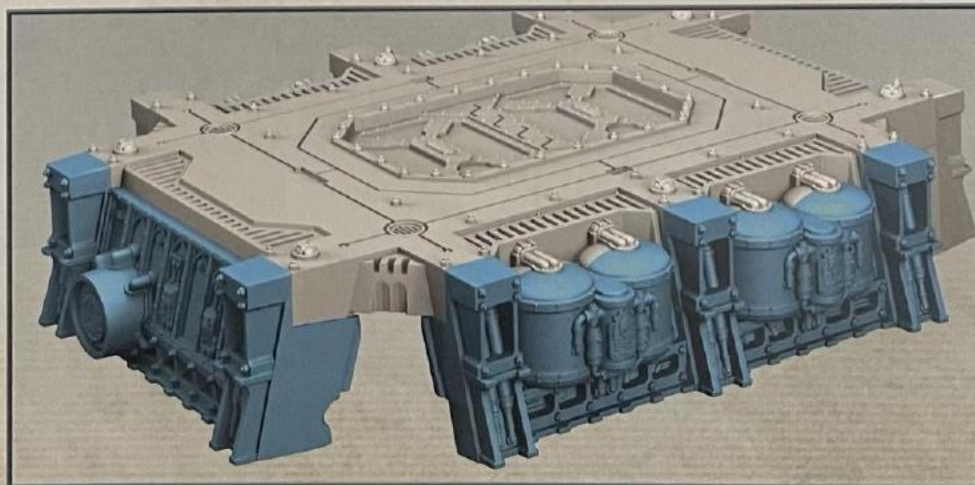
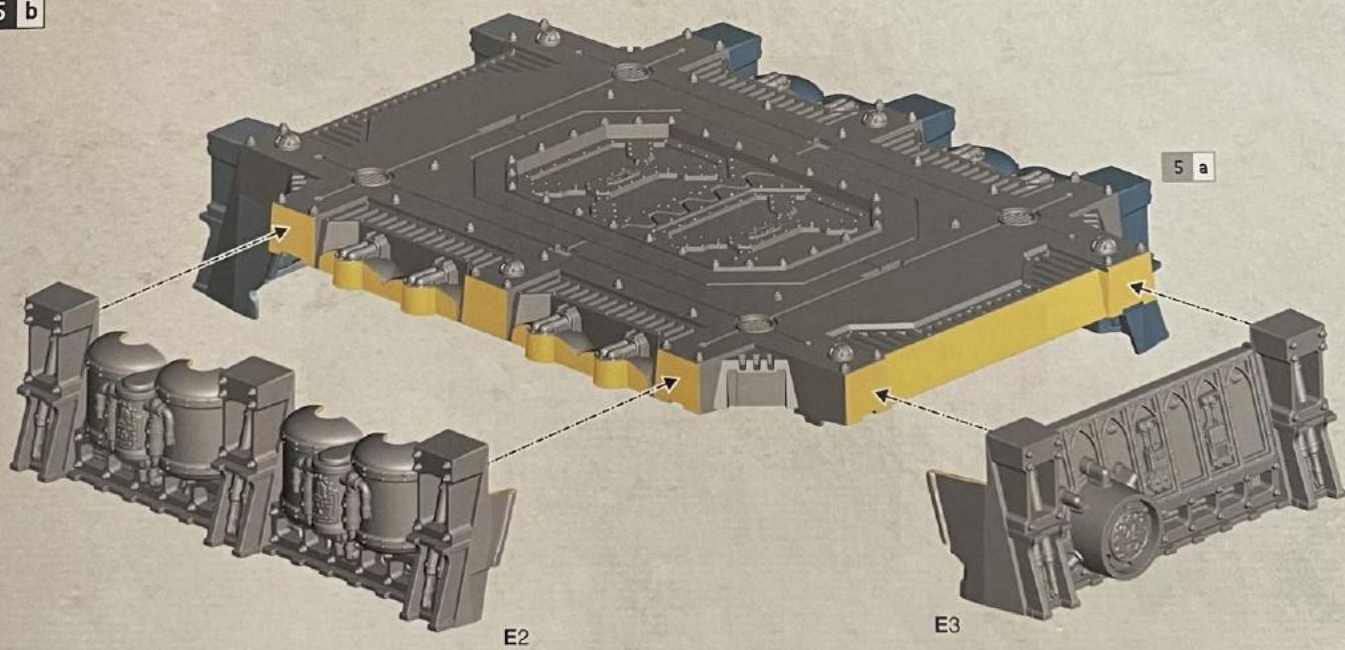

5 c

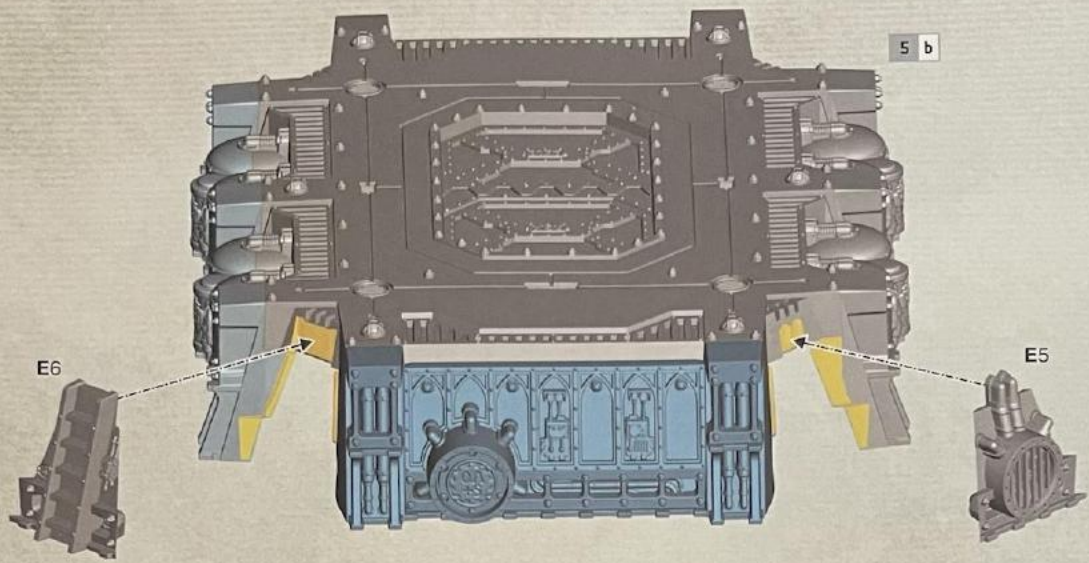

5 d

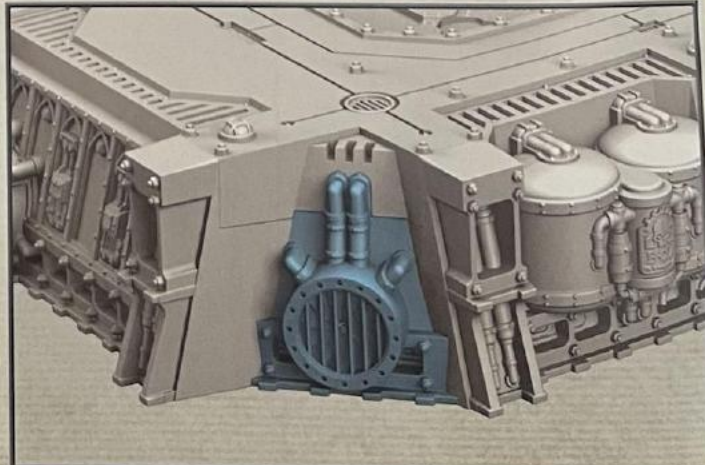
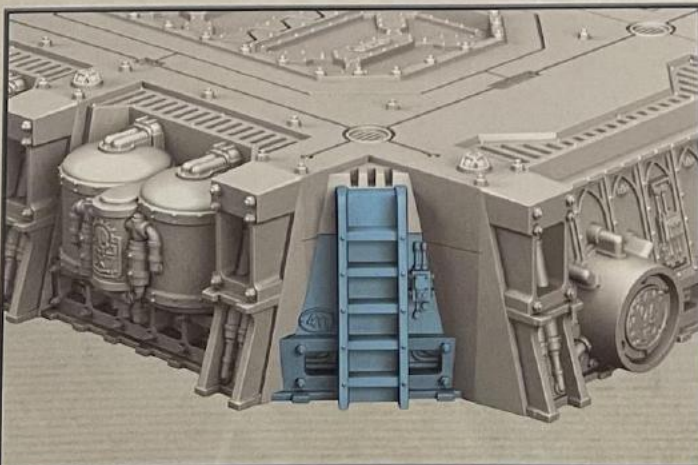
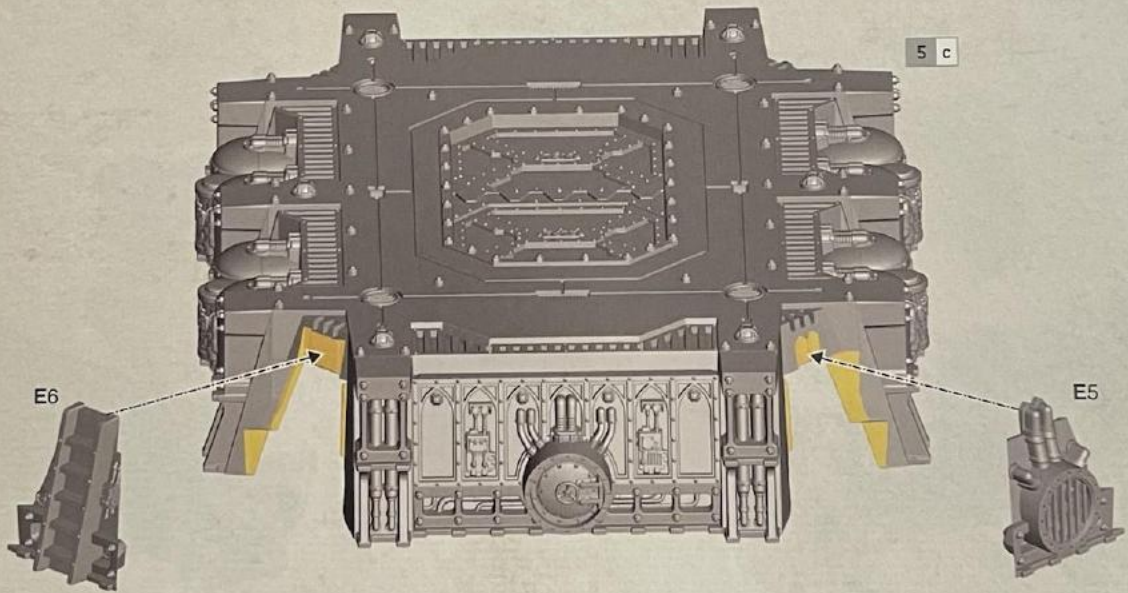

5 e

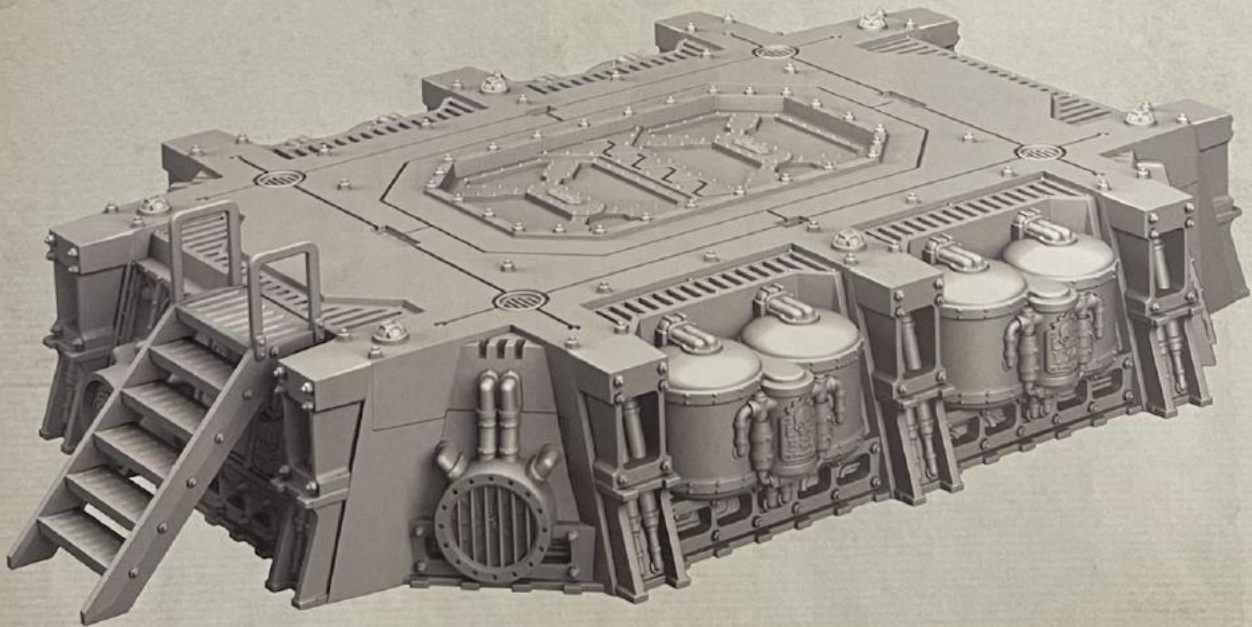
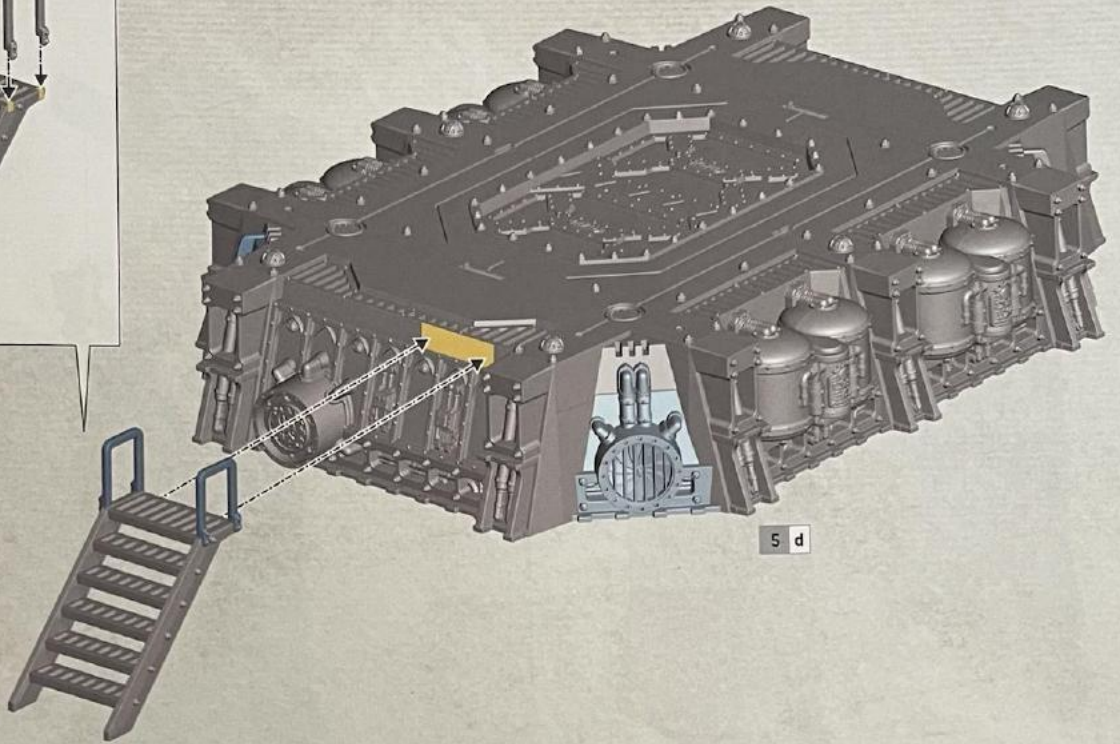
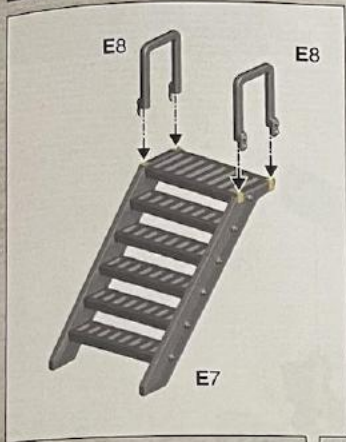

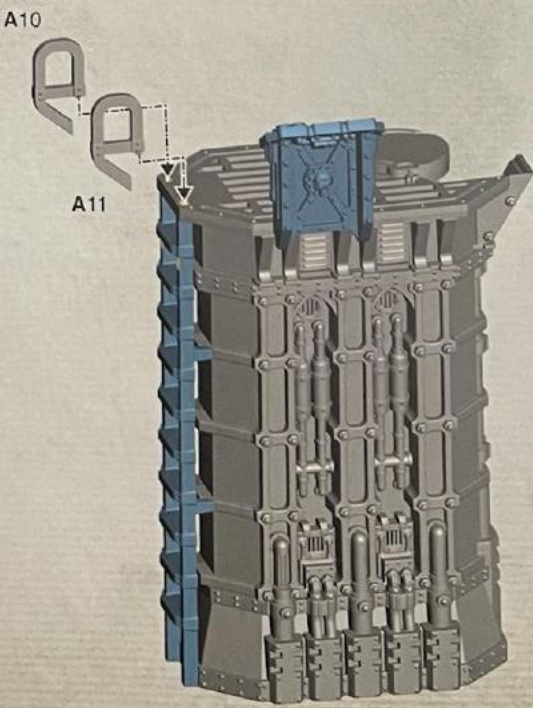
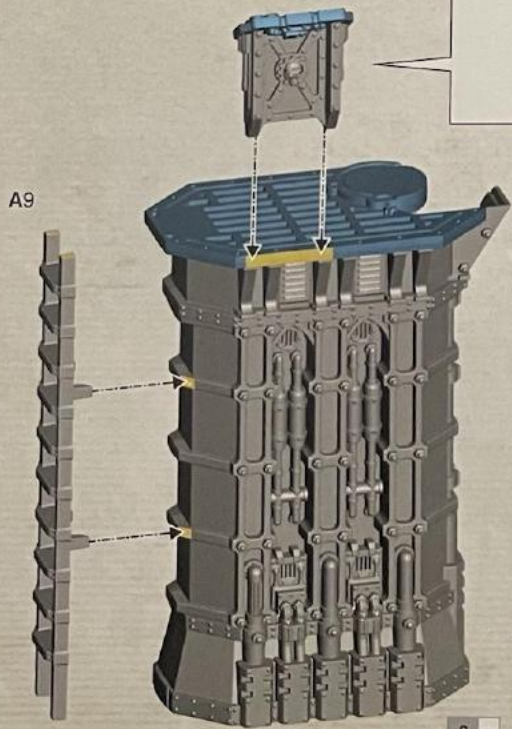
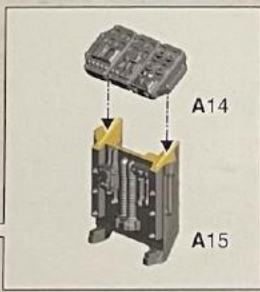
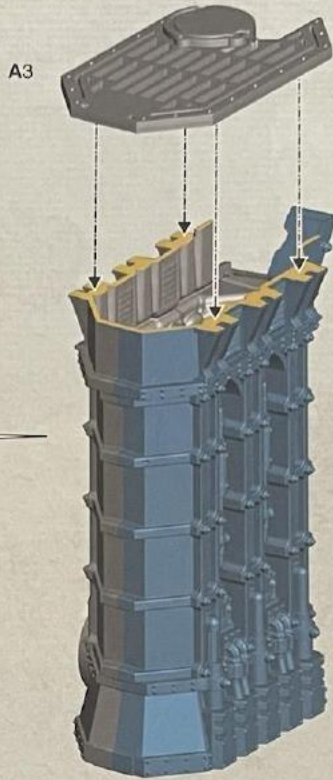
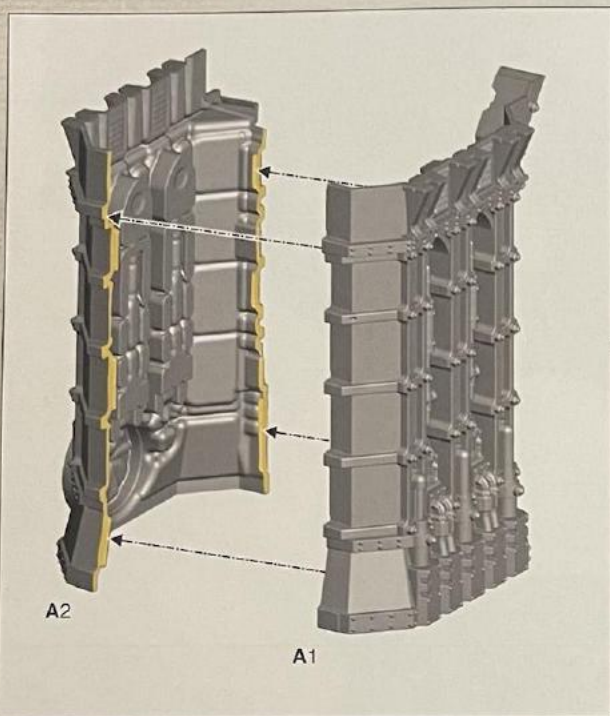

7

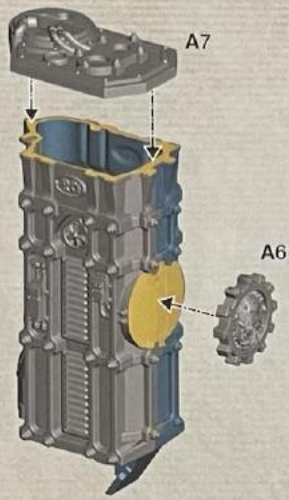
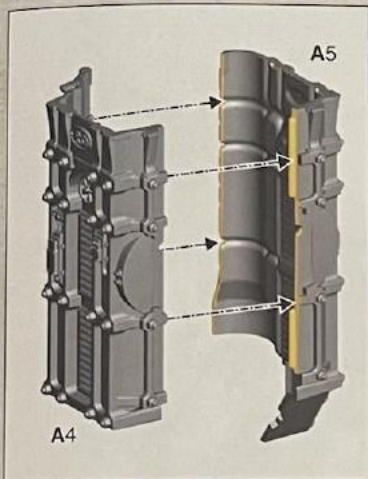

A13

A12



8

6

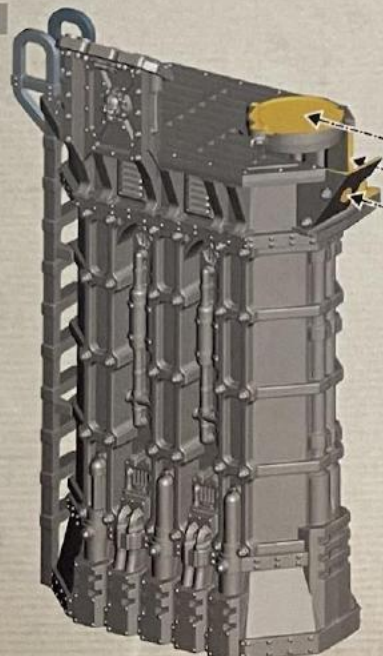

7

A8

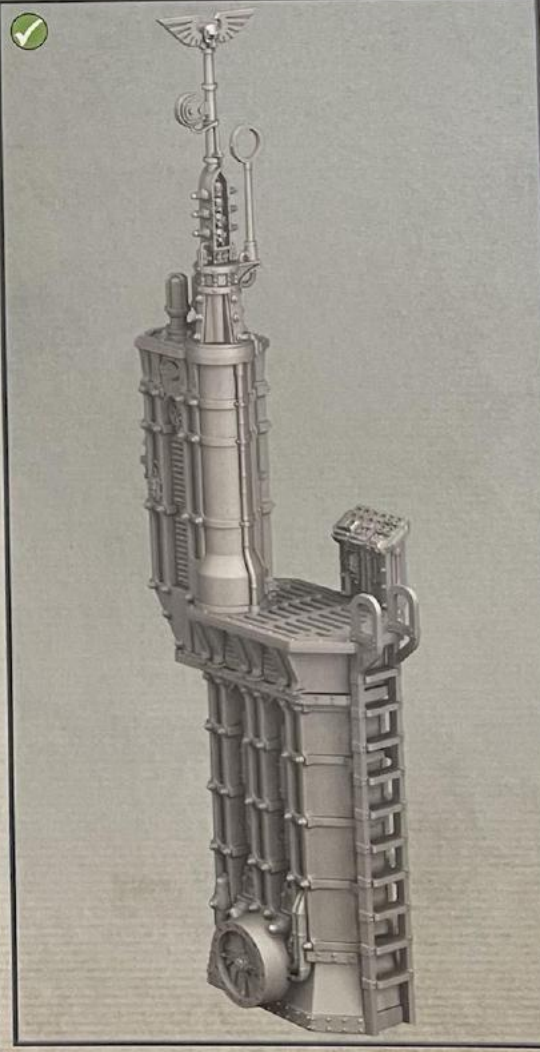
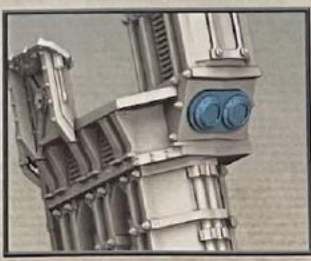

9 a

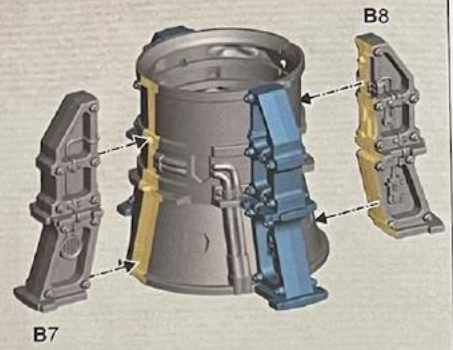
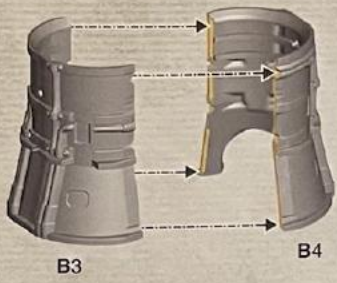

9 b

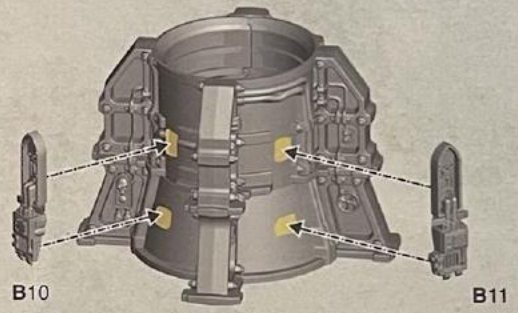
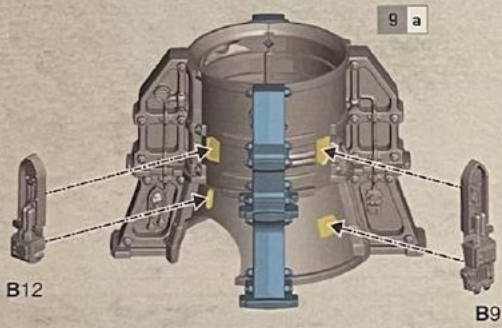

9 c

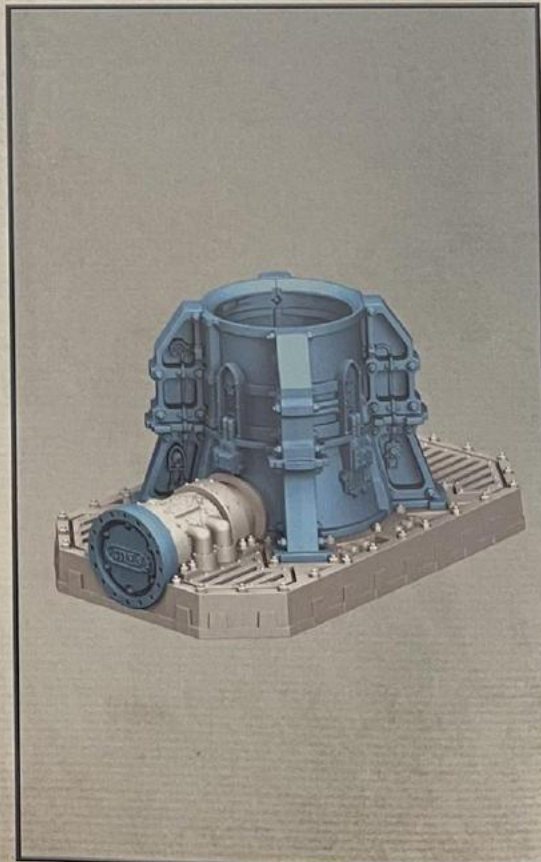
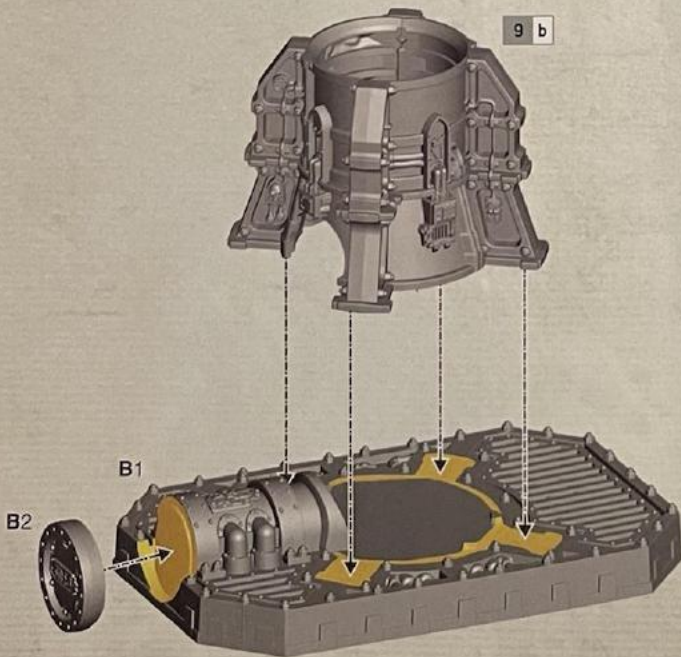

B15

B16

B17

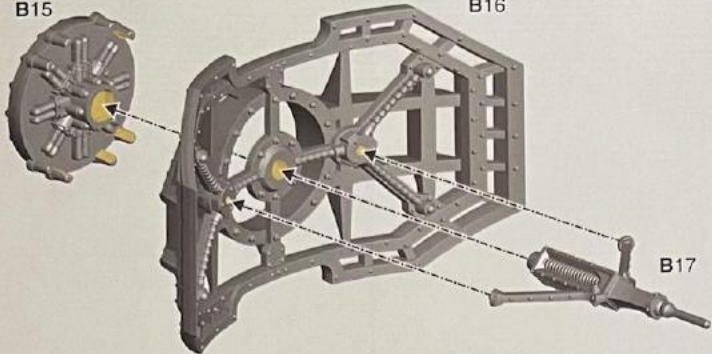

B14

B13



B18

B19

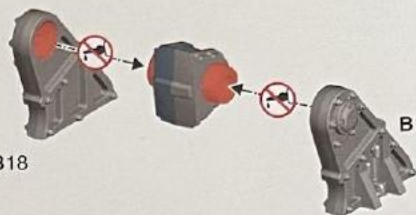

B21

B20





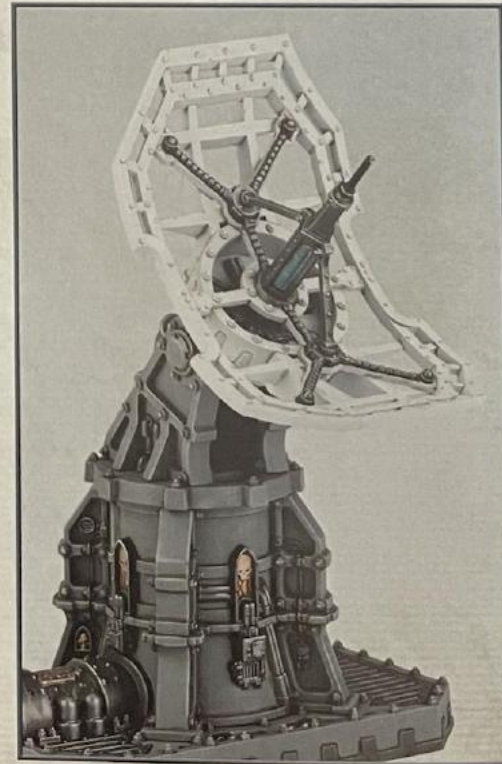
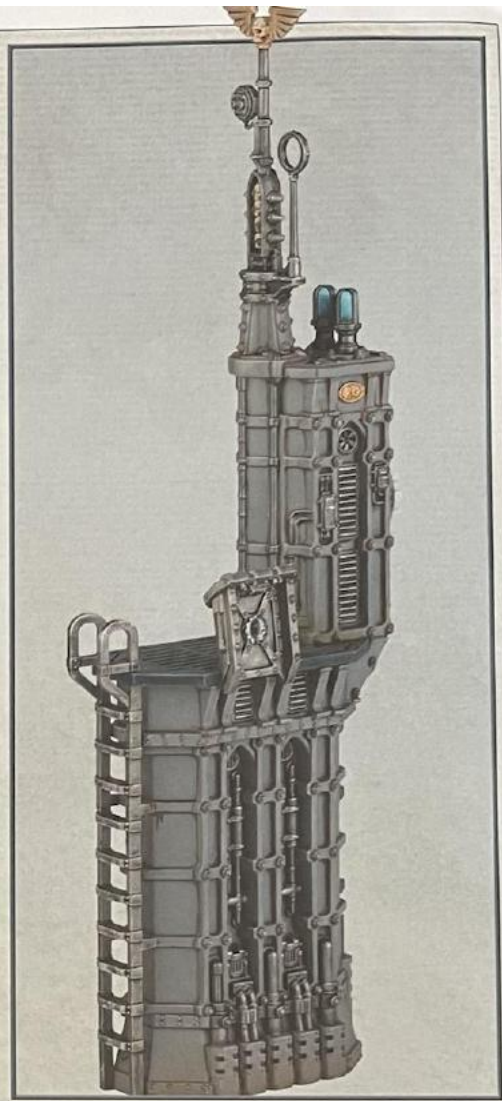
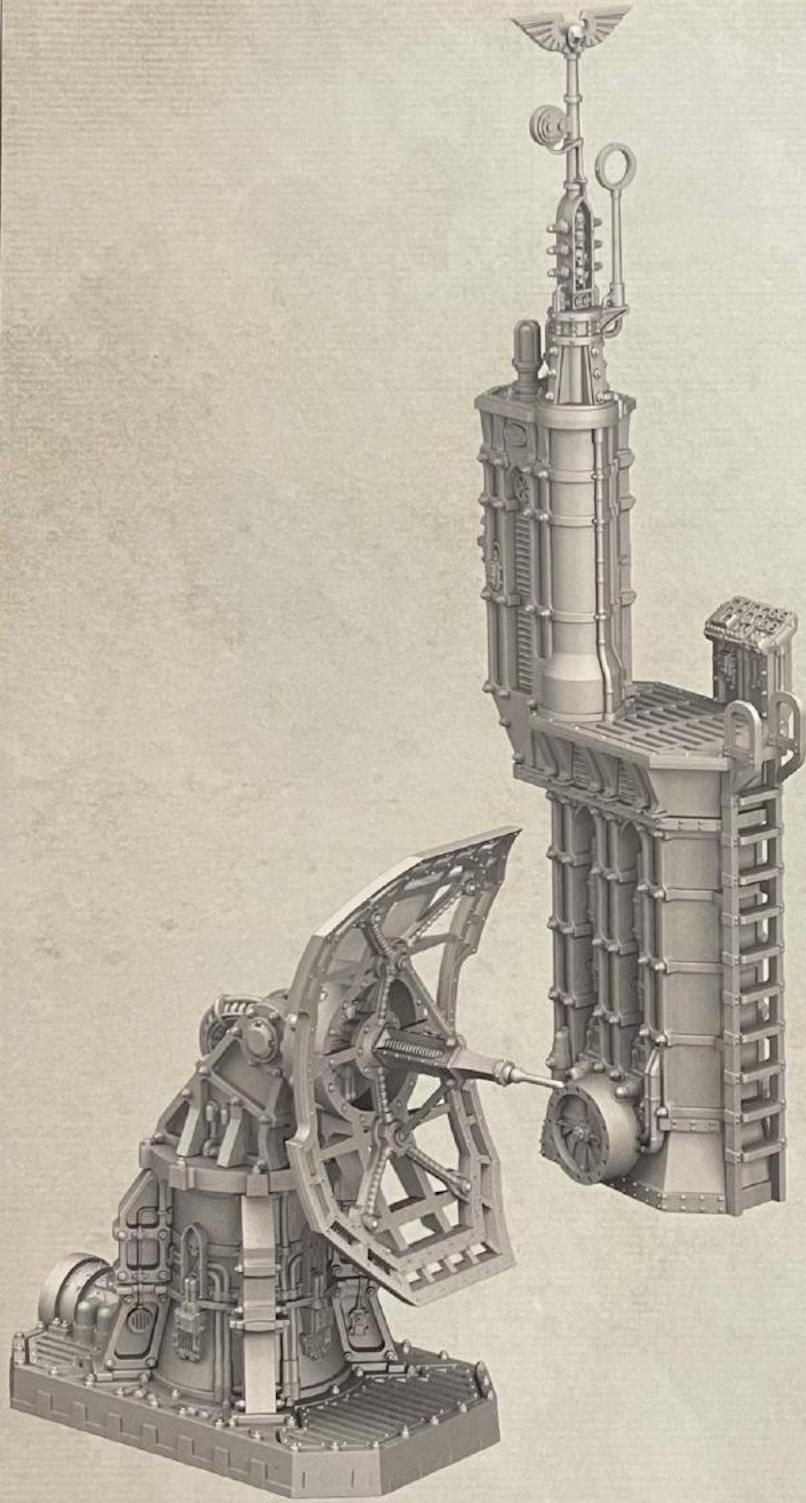

DESIGNED  
IN THE UK  
MADE IN CHINA

[warhammer.com](http://warhammer.com)

Games Workshop Limited, Willow Road, Nottingham, NG7 2WS, UK  
© Copyright Games Workshop Limited 2022.

