

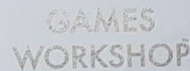







Free Downloads of Build Instructions,
Assembly Booklets & How To Guides

BuildInstructions.com

THE LORD OF THE RINGS

BATTLE OF OSGILIATH™ CONSTRUCTION BOOKLET DIE SCHLACHT UM OSGILIATH™ BAUANLEITUNG



- 
READ THIS FIRST: Before assembling your model kit, please read through the instructions in this booklet carefully. A pair of plastic cutters is required to remove the plastic components in this kit from their frame. We advise using a mouldline scraping tool to clean up the parts. To assemble your model, you will need plastic glue. Games Workshop sells Citadel Fine Detail Cutters, Citadel Mouldline Removers and Citadel Plastic Glue, but does not recommend these products for use by children under the age of 16 without adult supervision.
- 
À LIRE EN PREMIER : Avant de vous lancer dans l'assemblage de ce kit, veuillez lire attentivement les instructions de ce livret. Une pince coupante est requise pour détacher chaque élément de sa grappe. Nous vous recommandons l'utilisation d'un grattoir pour ébarber les éléments. Pour l'assemblage, vous aurez également besoin de colle plastique. Games Workshop commercialise les Pinces de Précision Citadel, l'Ébarboir Citadel et la Colle Plastique Citadel, mais n'en recommande pas l'utilisation pour des enfants de moins de 16 ans sans la supervision d'un adulte.
- 
LEER ANTES DE MONTAR: Antes de montar el contenido de este kit, lee estas instrucciones cuidadosamente. Te harán falta unas tenazas para plástico a fin de separar las piezas de la matriz. También aconsejamos una herramienta para rebabas a fin de limpiar cada pieza. Para montar la miniatura necesitarás pegamento para plástico. Games Workshop vende Tenazas Citadel, Herramientas para rebabas Citadel y Pegamento para plástico Citadel, pero no recomienda estos productos a menores de 16 años sin la supervisión de un adulto.
- 
LIES DIES ZUERST: Lies diese Anleitung sorgfältig, bevor du mit dem Zusammenbau deines Modells beginnst. Du benötigst einen Kunststoffseitenschneider, um die Kunststoffbauteile aus dem Gussrahmen herauszutrennen, und Kunststoffkleber, um die Miniatur zusammenzubauen. Außerdem empfehlen wir, die Bauteile vorher mit einem Gussgratentferner zu säubern. Games Workshop bietet Präzisions-Kunststoffseitenschneider von Citadel sowie Citadel-Kunststoffkleber an, empfiehlt aber, dass Kinder unter 16 Jahren diese nur unter Aufsicht eines Erwachsenen benutzen.
- 
LEGGI PRIMA QUESTO: prima di assemblare il tuo modello, leggi le istruzioni di questo libretto con attenzione. Sono necessarie un paio di tronchesine per plastica per staccare i componenti dal loro sprue. Consigliamo di usare un attrezzo apposito per pulire i componenti. Per assemblare il modello avrai bisogno di colla per plastica. Games Workshop vende Tronchesine di precisione Citadel, Attrezzo per ripulire Citadel e Colla per plastica Citadel, ma non consiglia questi prodotti ad un pubblico minore di 16 anni senza la supervisione di un adulto.
- 
优先阅读: 组装模型前, 请先仔细阅读本手册中的说明。需要用模型剪钳将塑料部件从板上剪下。我们推荐使用合模线清理工具来清理零件。用塑料粘胶来组装模型。Games Workshop 销售 Citadel 精密剪钳、Citadel 合模线刮刀和 Citadel 塑料粘胶, 但不建议未满 16 岁的儿童在没有成人的监护下使用此类产品。
- 
最初にお読みください: ミニチュアを組み立てる前に、この冊子の説明をよくお読みください。本セット内フレームからプラスチックパーツを切り取るためにプラスチック用ニッパーが必要となります。その後パーツを滑らかにするため、モールドラインを削るためのツールの使用を推奨します。モデルの組み立てには、プラスチック接着剤が必要となります。ゲームワークショップでは「シタデルファイナディテールニッパー」「シタデルモールドラインリムーバー」「シタデルプラスチック接着剤」を販売していますが、これらは保護者の監督なしでの16歳以下のお子様の使用を推奨しません。



Citadel Plastic Glue
Colle plastique liquide Citadel
Pegamento para plástico fluido
Citadel-Kunststoffkleber
Colla per plastica fluida Citadel
Citadel 塑料灌缝粘胶
シタデルプラスチック接着剤直し込みタイプ







Citadel Fine Detail Cutters
Pinces de précision Citadel
Tenazas Citadel
Citadel-Seitenschneider
Tronchesine di precisione Citadel
Citadel 精密剪钳
シタデルファイナディテールニッパー



Citadel Mouldline Remover
Ébarboir Citadel
Herramienta para rebabas Citadel
Gussgratentferner
Attrezzo per ripulire Citadel
Citadel 合模线刮刀
シタデルモールドラインリムーバー

**EXPLANATION OF SYMBOLS • EXPLICATION DES SYMBOLES
EXPLICACIÓN DE SIMBOLOS • ERLÄUTERUNG DER SYMBOLE
LEGENDA DEI SIMBOLI • 符号说明 • 記号の説明**

 <p>Choice of parts Choix d'éléments Modelos de componentes Auswahl an Teilen Scelta di componenti 零件选择 パーツ選択</p>	 <p>Variant assembly Variante d'assemblage Variante de montage Bauvariante Assemblaggio alternativo 多种组装方案 組み立てのバリエーション</p>
 <p>Stage complete Étape terminée Paso completado Schritt abgeschlossen Fase completa 部件组装完成 完了</p>	 <p>Rotate part Faire pivoter Girar la pieza Teil drehen Ruota il componente 旋转部件 向きを変更</p>
 <p>Do not glue the components Ne pas coller les éléments No pegar los componentes Bitte die Teile nicht kleben Non incollare i componenti 请勿粘接 接着しないこと。</p>	

© New Line Productions, Inc. All rights reserved. MIDDLE-EARTH, THE LORD OF THE RINGS: THE FELLOWSHIP OF THE RING; THE LORD OF THE RINGS: THE TWO TOWERS; THE LORD OF THE RINGS: THE RETURN OF THE KING and the names of the characters, items, events and places therein are ™ of The Saul Zaentz Company d/b/a Middle-earth Enterprises under license to New Line Productions, Inc. (s22)



© Copyright Games Workshop Limited 2022. Citadel and Games Workshop are ® and all associated logos are either ® or TM and/or © Games Workshop Limited.



Madril, Captain of Ithilien • Madril, Hauptmann von Ithilien

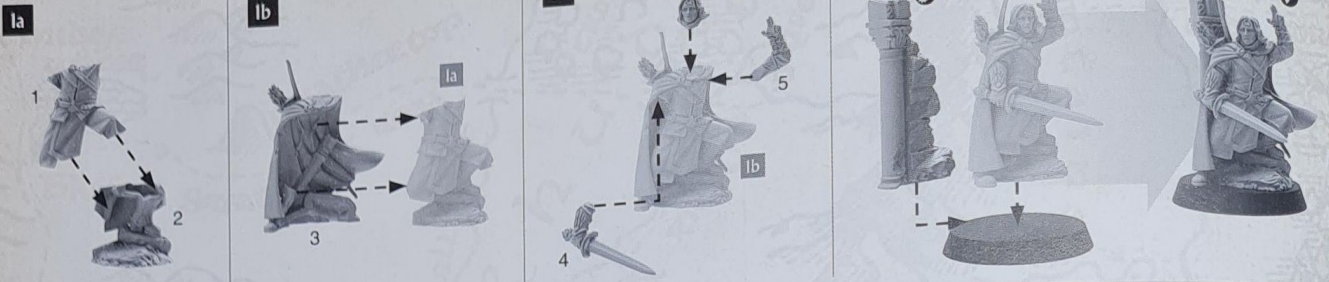

Faramir, Captain of Gondor • Faramir, Hauptmann von Gondor

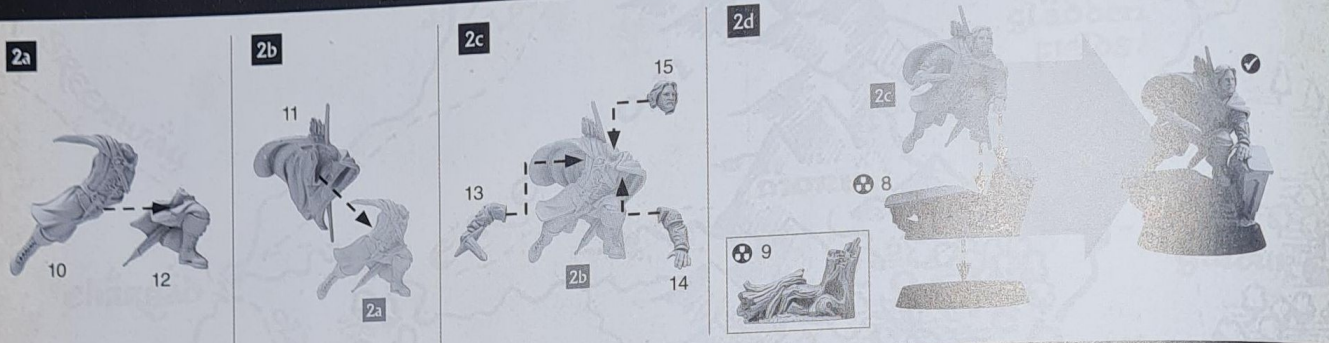

Damrod, Ranger of Ithilien • Damrod, Waldläufer von Ithilien

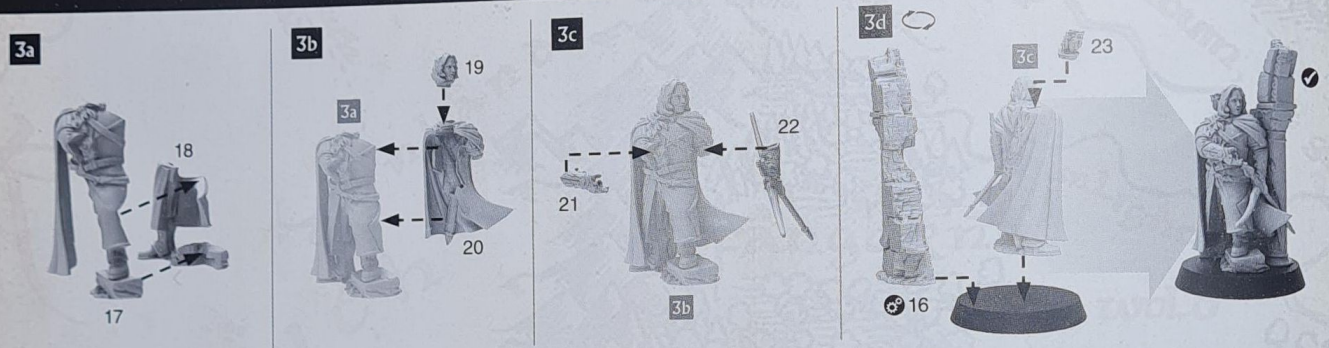

Gothmog, Lieutenant of Sauron on Foot • Gothmog, Saurons Statthalter zu Fuß

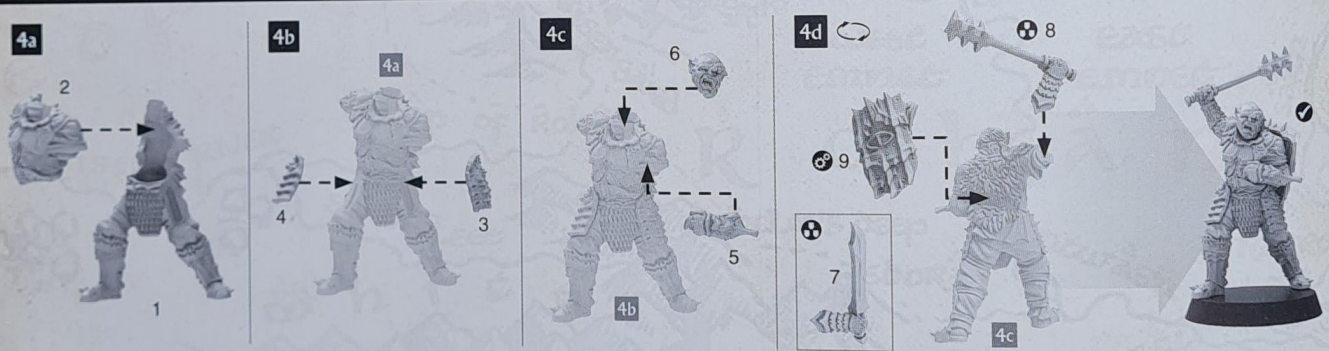

Gothmog, Lieutenant of Sauron Mounted • Gothmog, Saurons Statthalter beritten

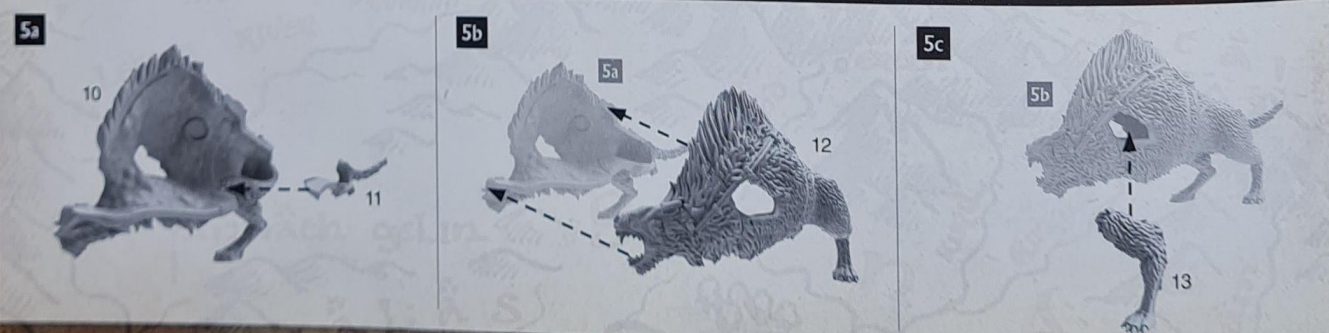

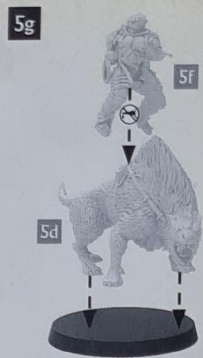
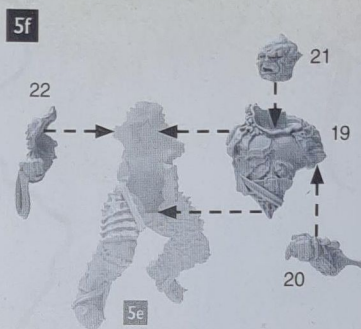
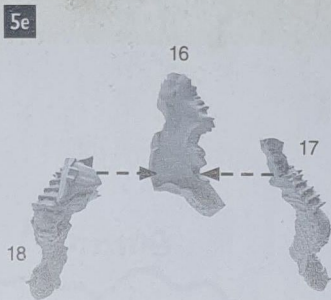

! Note: For the purposes of game balance, we recommend not attaching the separate shield to Gothmog when playing through the Scenarios contained in the *Battle of Osgiliath Scenarios & Profiles* booklet. Of course, you can add it if you wish, or, once you've played through the Scenarios, add it to your model later.

Mordor Troll • Mordor-Troll

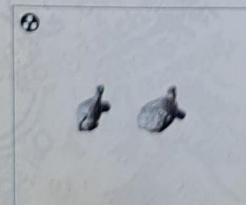
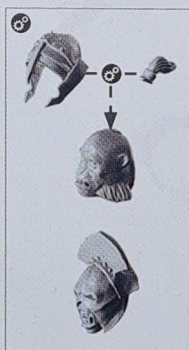
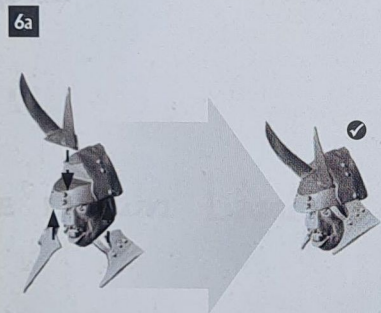

! Note: If you are planning on playing through the Scenarios contained in the *Battle of Osgiliath Scenarios & Profiles* booklet, we recommend building your Mordor Troll with a hammer. Of course, you can build it however you wish if you do not plan on playing through the Scenarios.

7



8



! Note: For the purposes of game balance, we recommend not attaching the separate shields to your Morannon Orcs when playing through the Scenarios contained in the *Battle of Osgiliath Scenarios & Profiles* booklet. Of course, you can add them if you wish, or, once you've played through the Scenarios, add them to your models later.

Gondor Ruin A • Ruine von Gondor A

9a

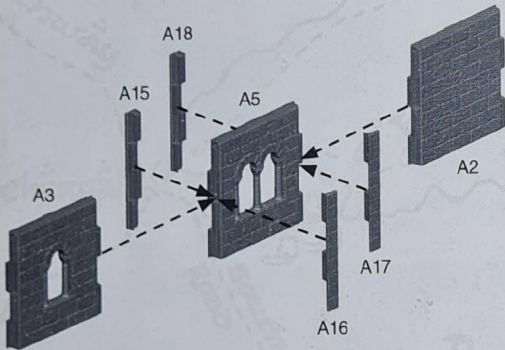

9b

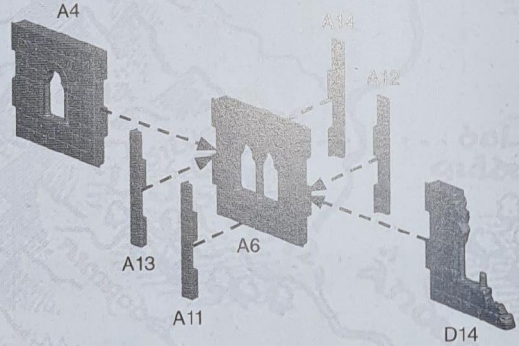

9c

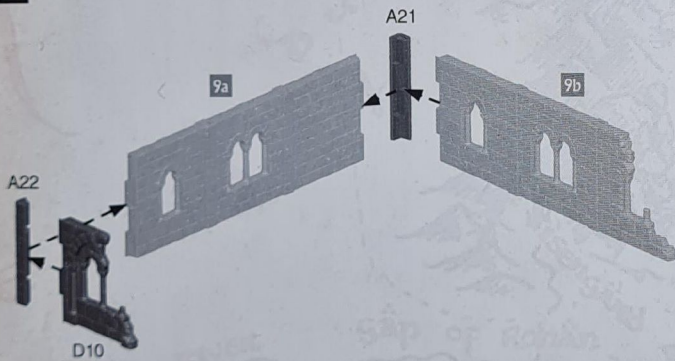

9d

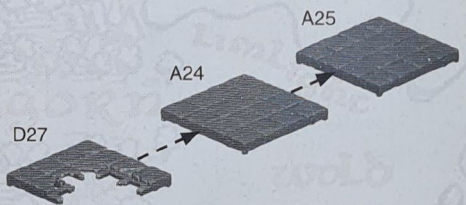

9e

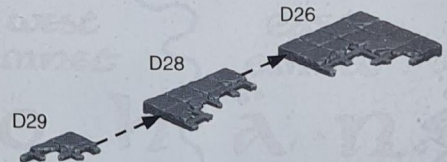

9f



9g

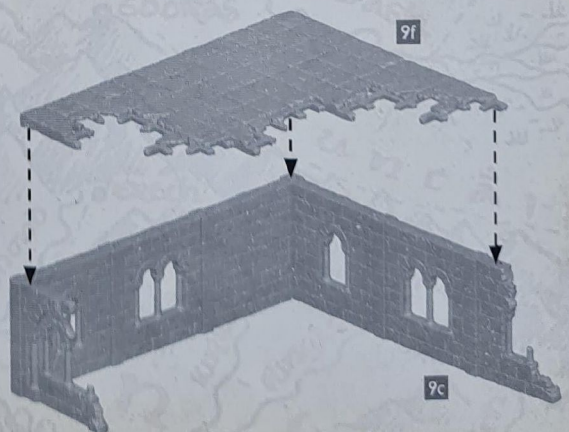

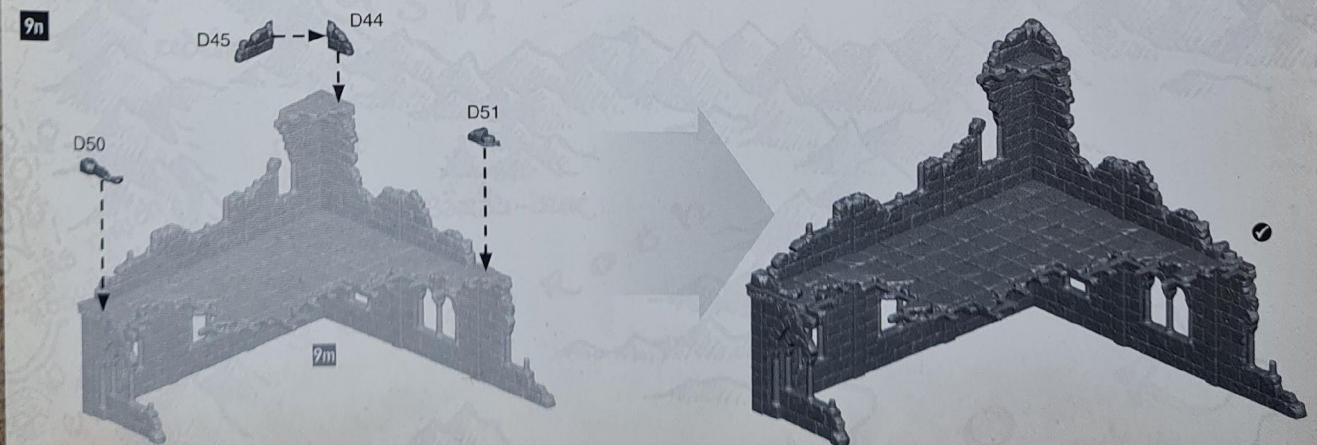
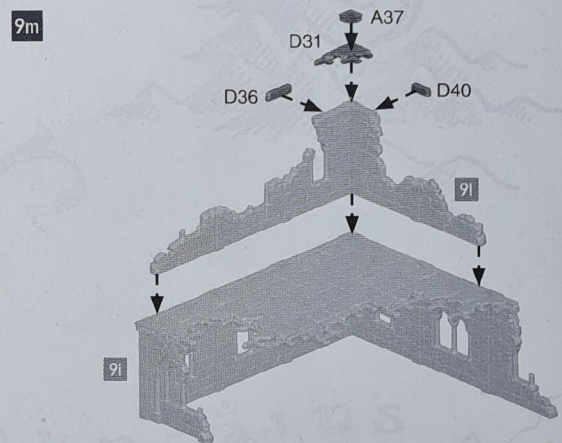
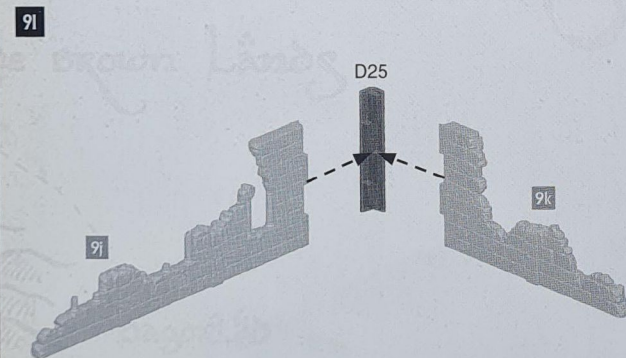
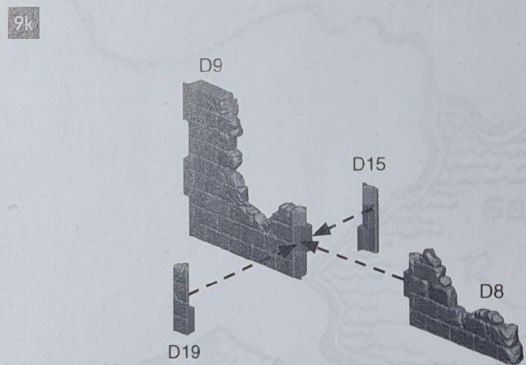
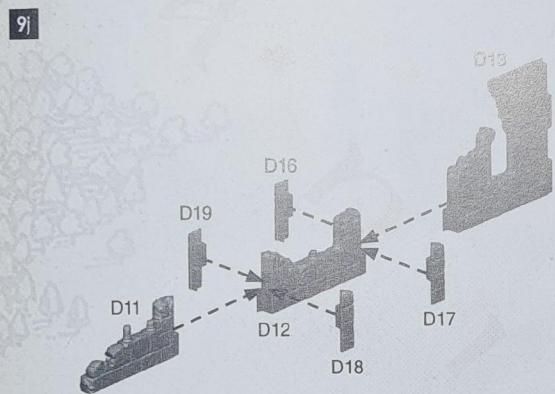
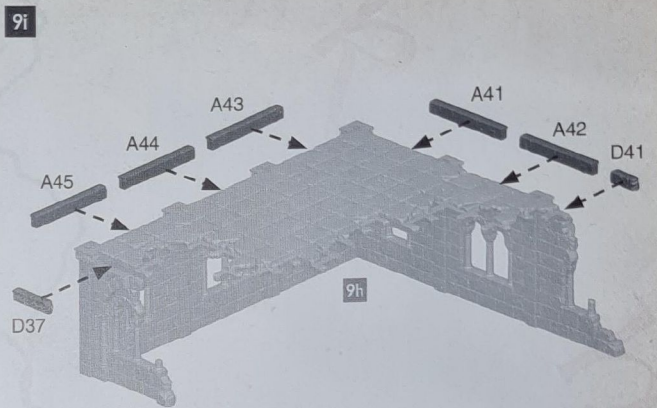
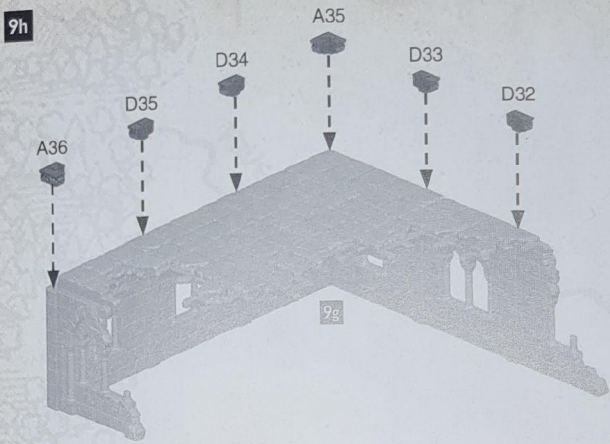

10a

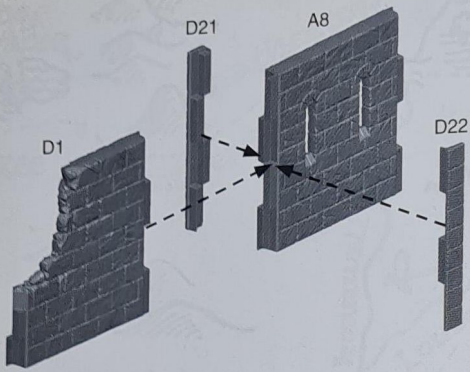

10b

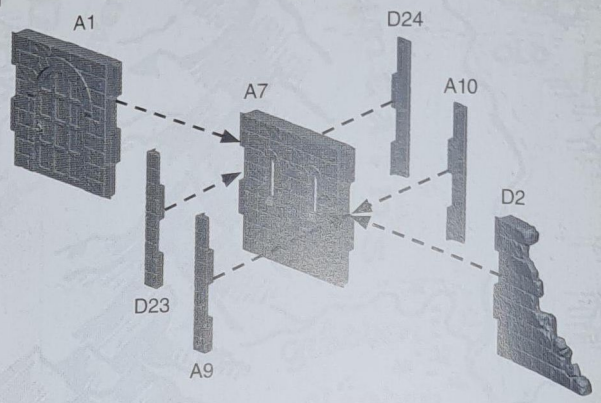

10c

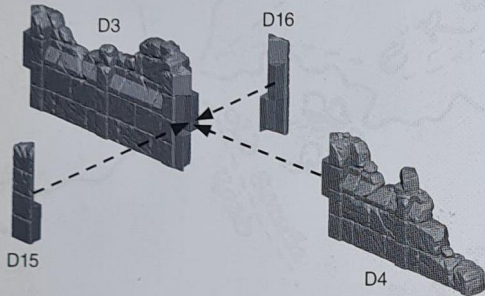

10d

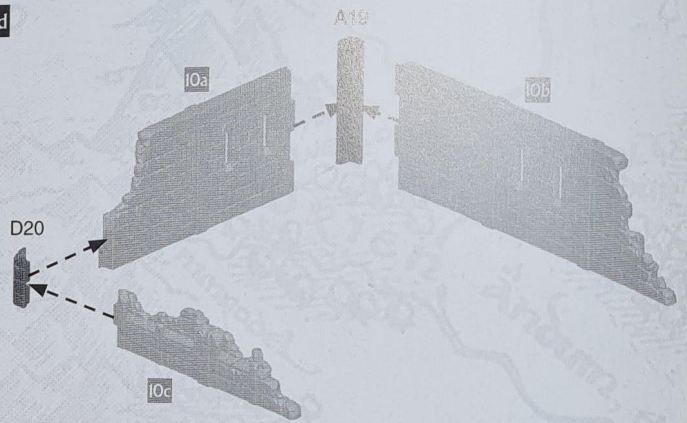

10e

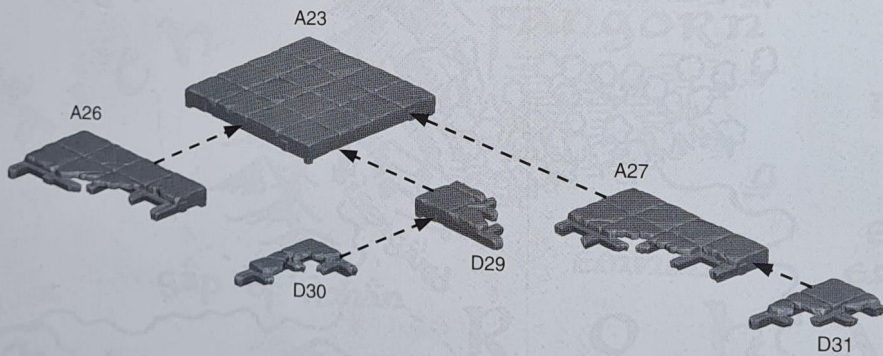

10f

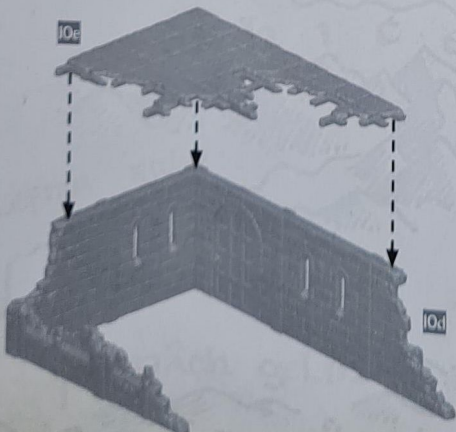

10g

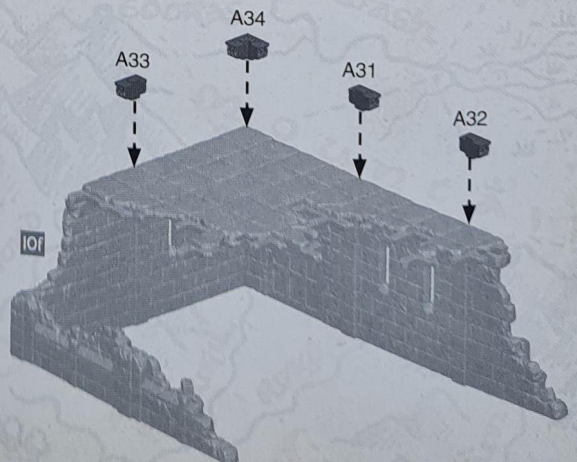

10h

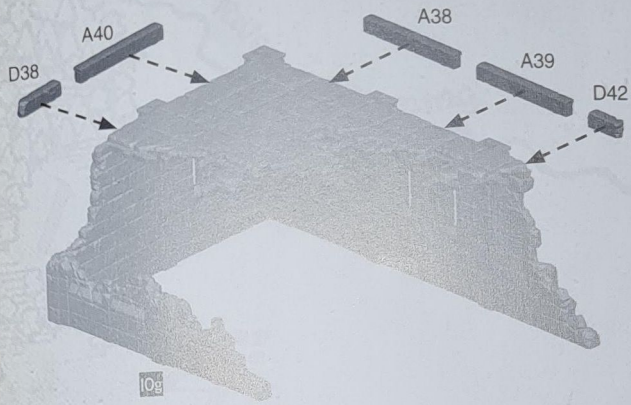

10g

10i

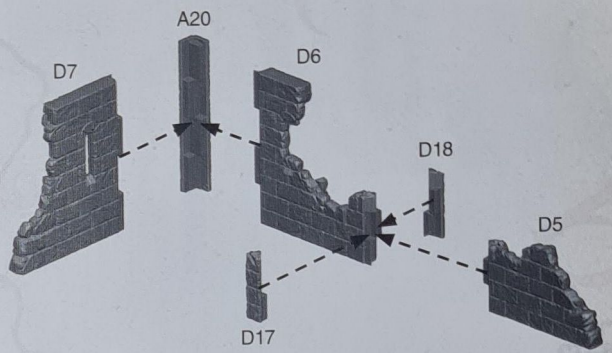

10j

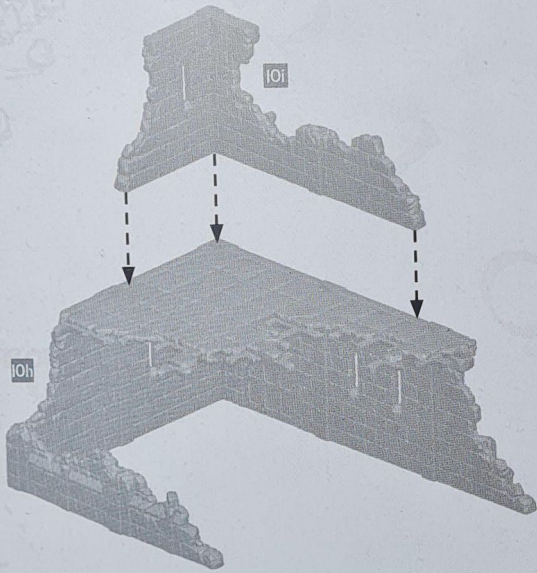

10h

10k

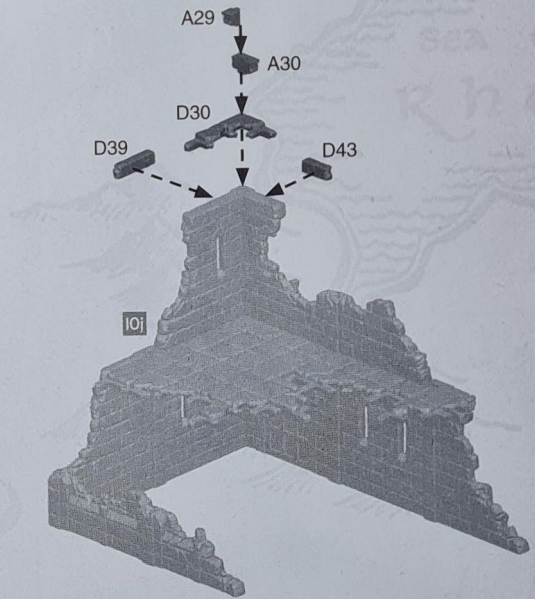

10j

10l

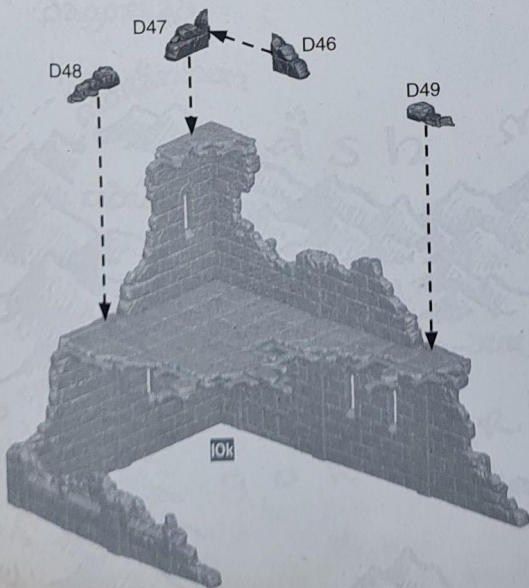

10k

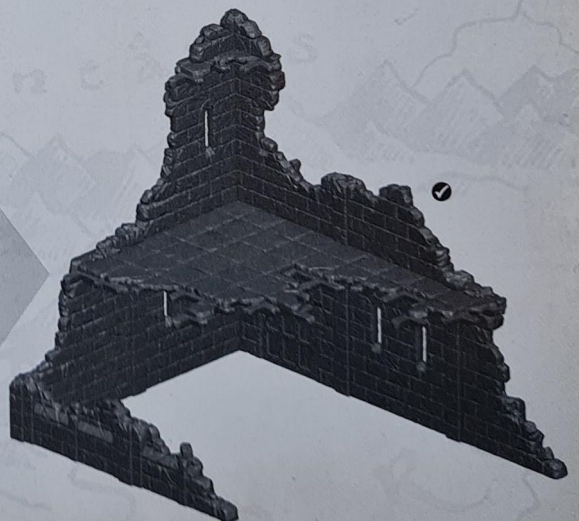

IIa

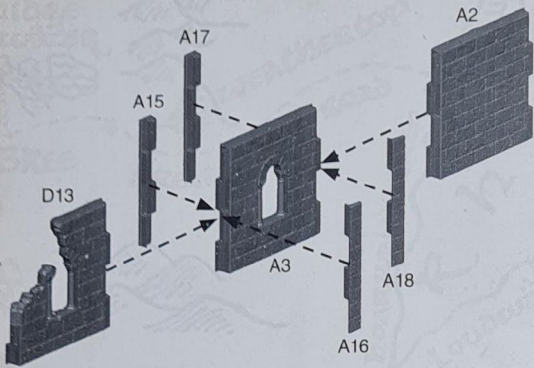

IIb

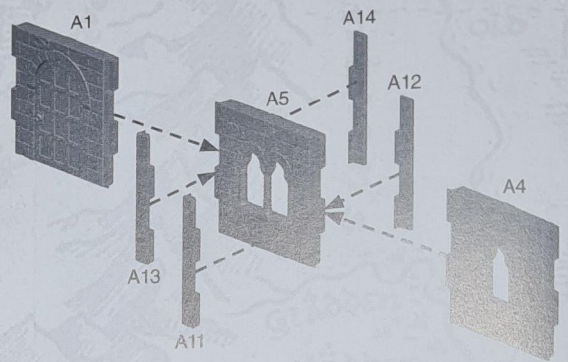

IIc

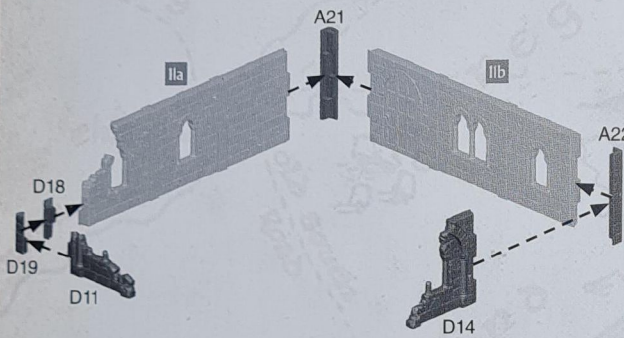

IIId

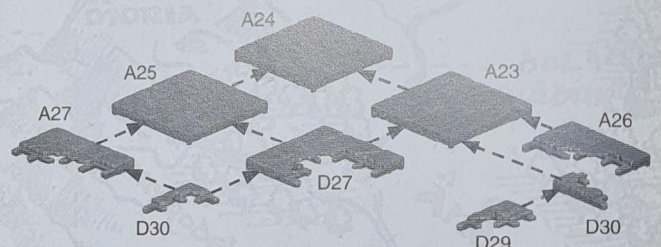

IIe

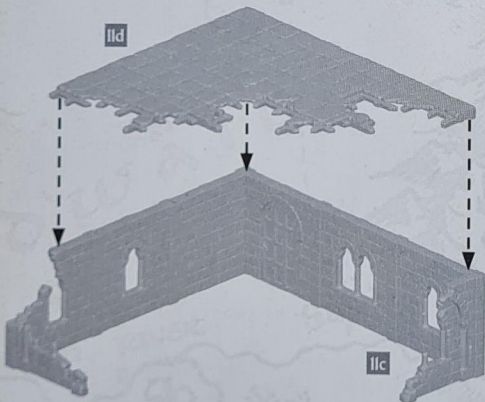

IIIf

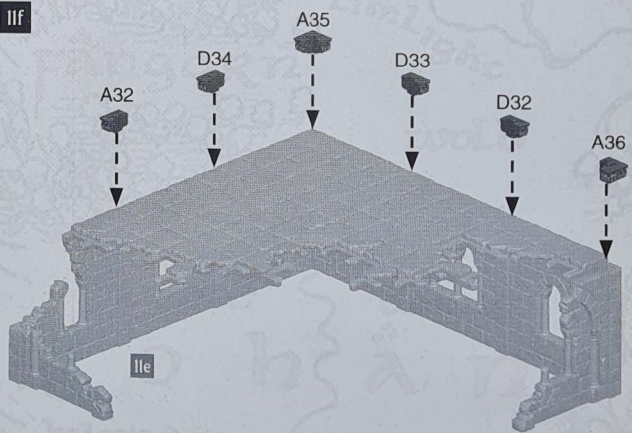

IIg

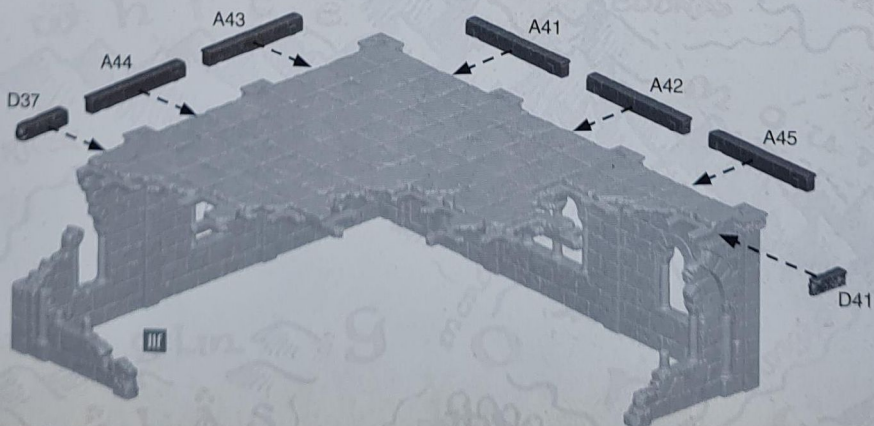

11h

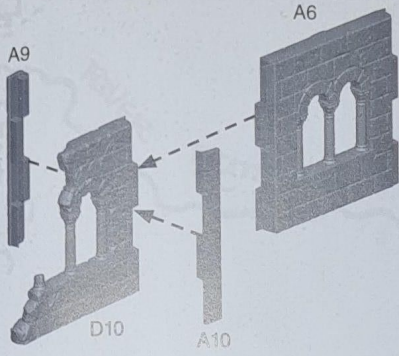

11i

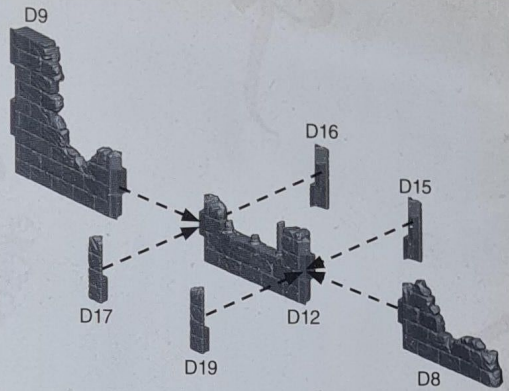

11j



11k

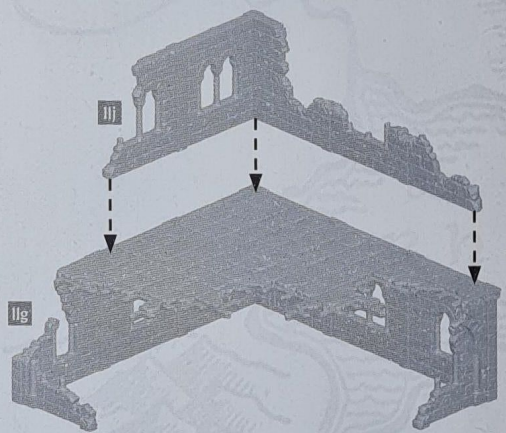

11l

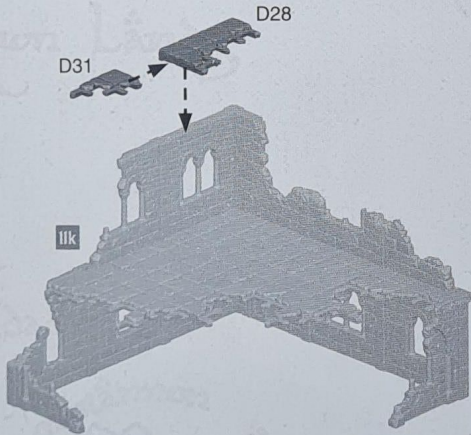

11m

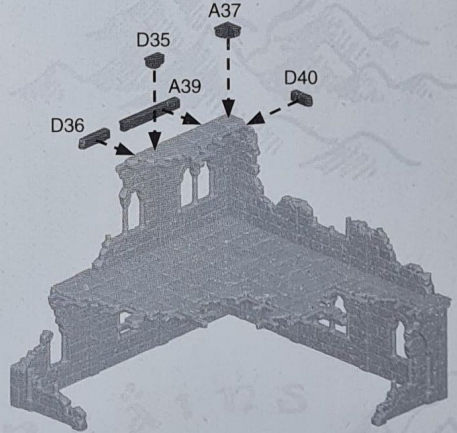

11n

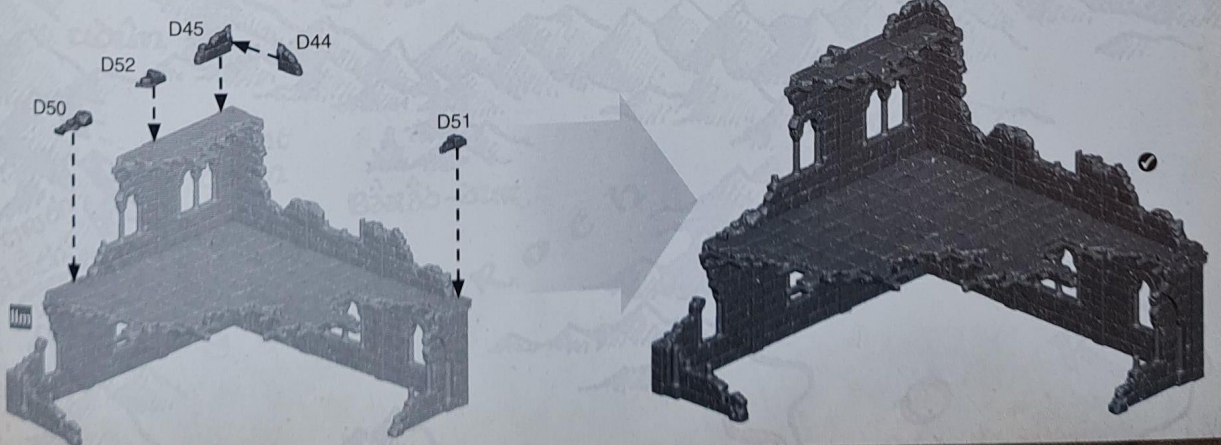

12a

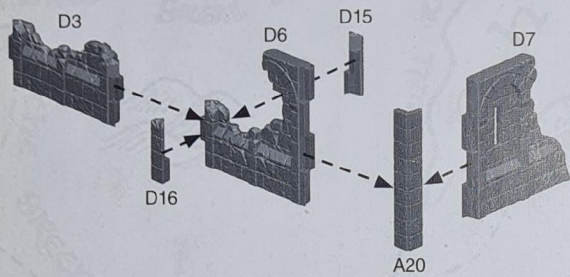

12b

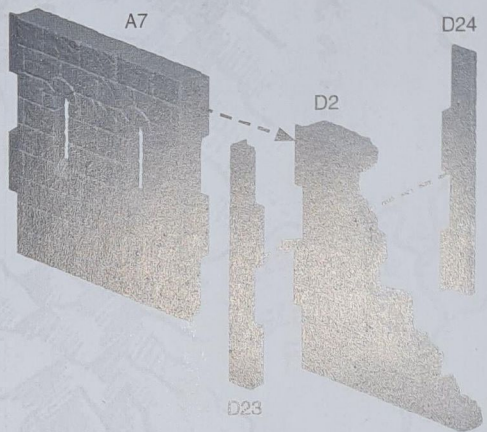

12c

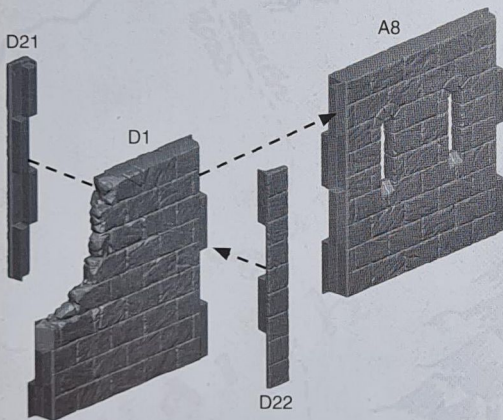

12d

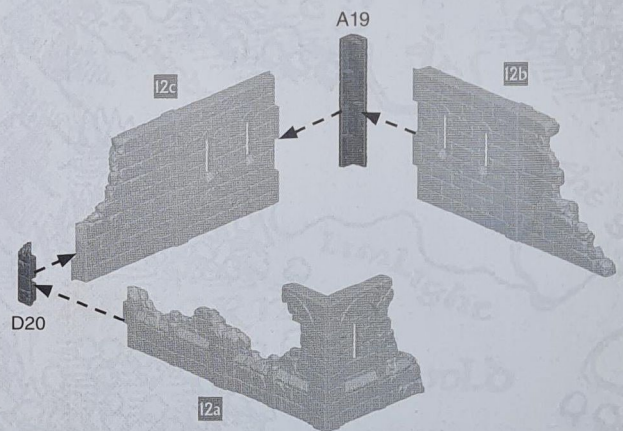

12e

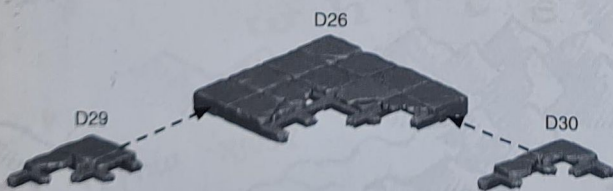

12f

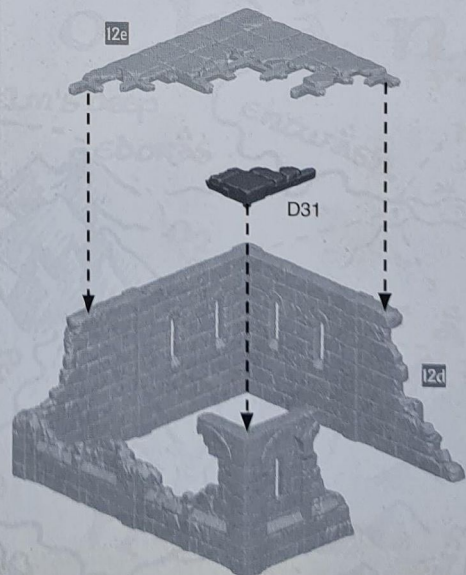

12g

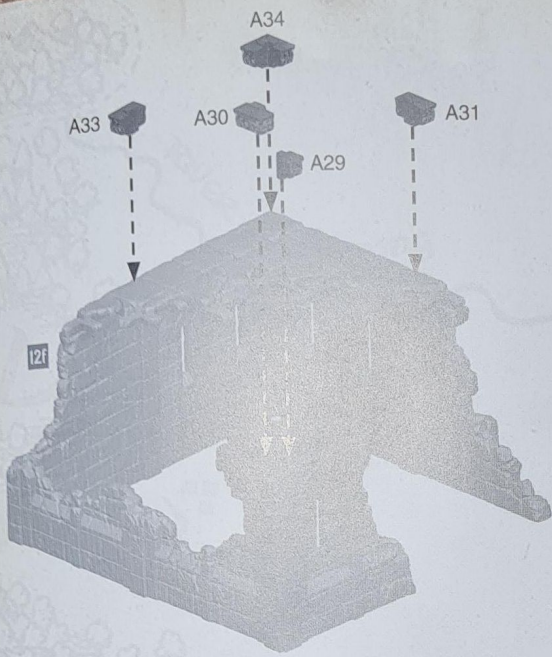

12f

12h

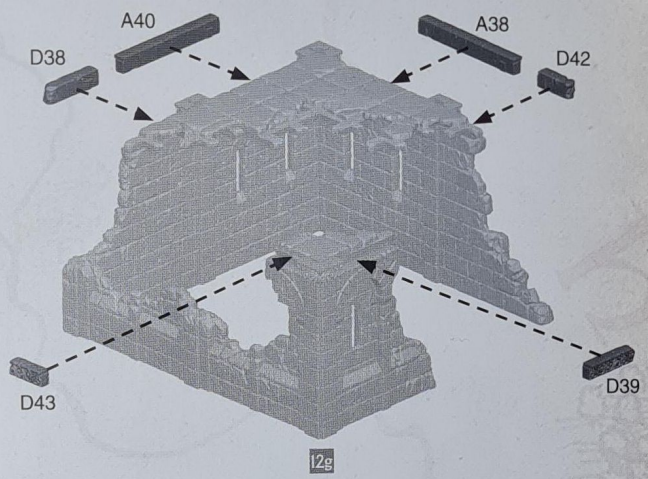

12g

12i

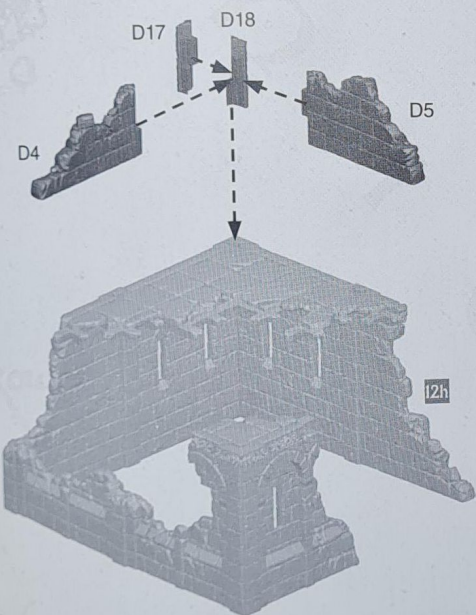

12h

12j

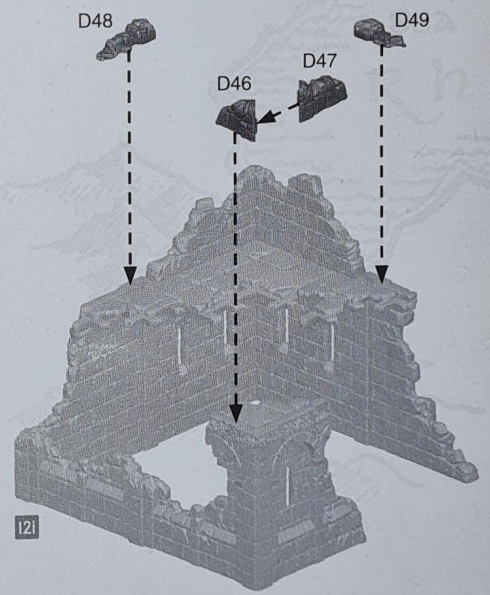

12i

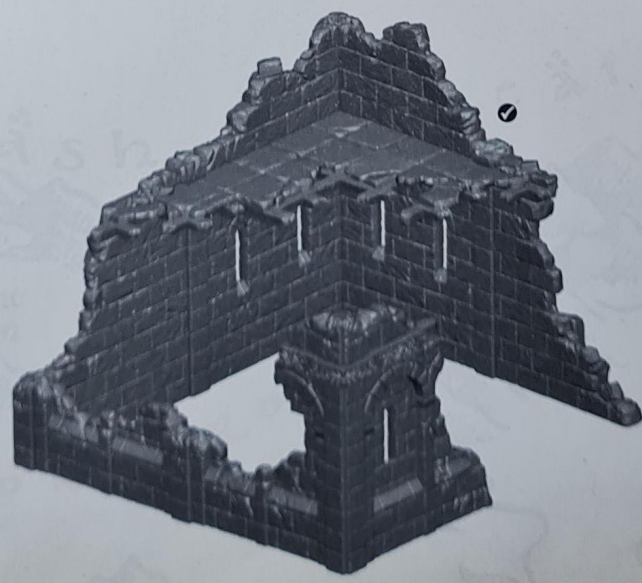

MODEL SHOWCASE



Faramir, Captain of Gondor



Damrod, Ranger of Ithilien



Madril, Captain of Ithilien



Ranger of Gondor



Warrior of Minas Tirith



Gothmog, Lieutenant of Sauron



Morannon Orcs



Mordor Troll

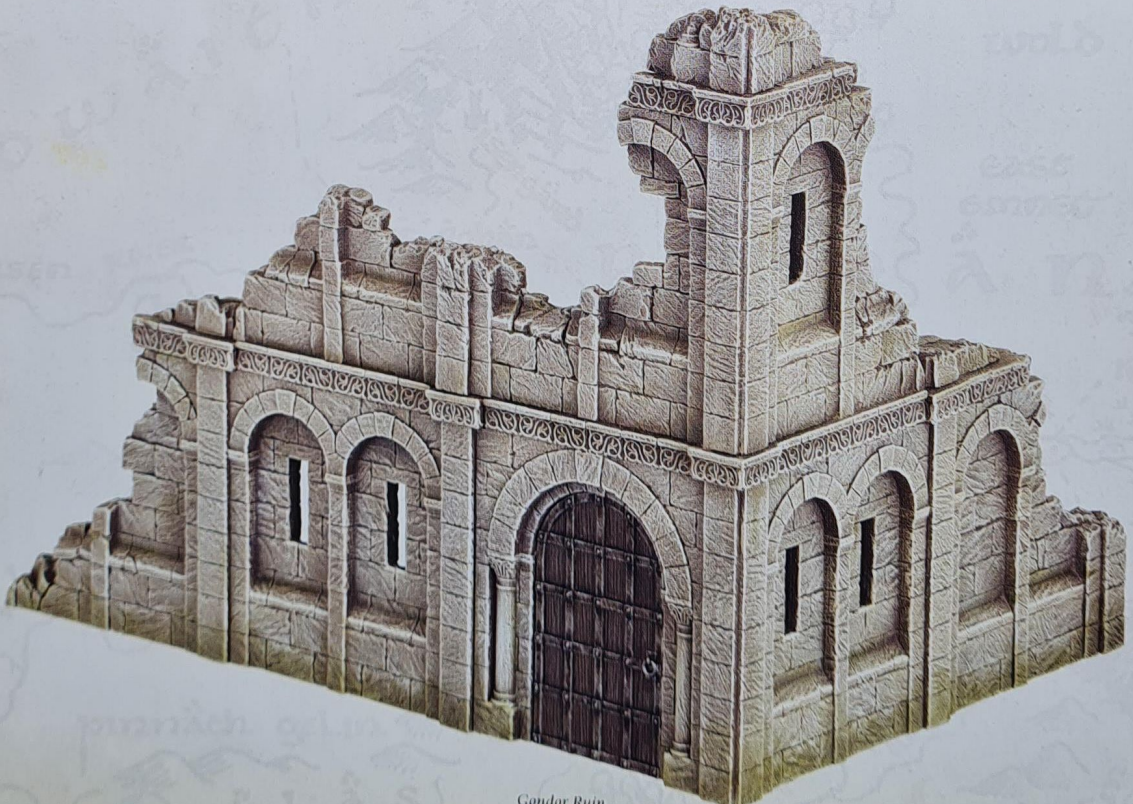

Gondor Ruin