



Free Downloads of Build Instructions,
Assembly Booklets & How To Guides

BuildInstructions.com

ADEPTUS TITANICUS

WARLORD-SINISTER PSI-TITAN

A weapon of hidden terror and secrecy, dark rumours speak of the Warlord-Sinister as a 'Psi-Titan', a macabre variant of the more conventional Warlord battle Titan. Bound through arcane technologies to enslaved alpha-grade psykers, the esoteric machinery of the Titan's Ciricrux Anima is capable of channelling the power of the Empyrean through the Sinistramanus Tenebrae, a weapon of nightmarishly destructive force which is able to shatter reality itself, dragging its victims into the Warp.

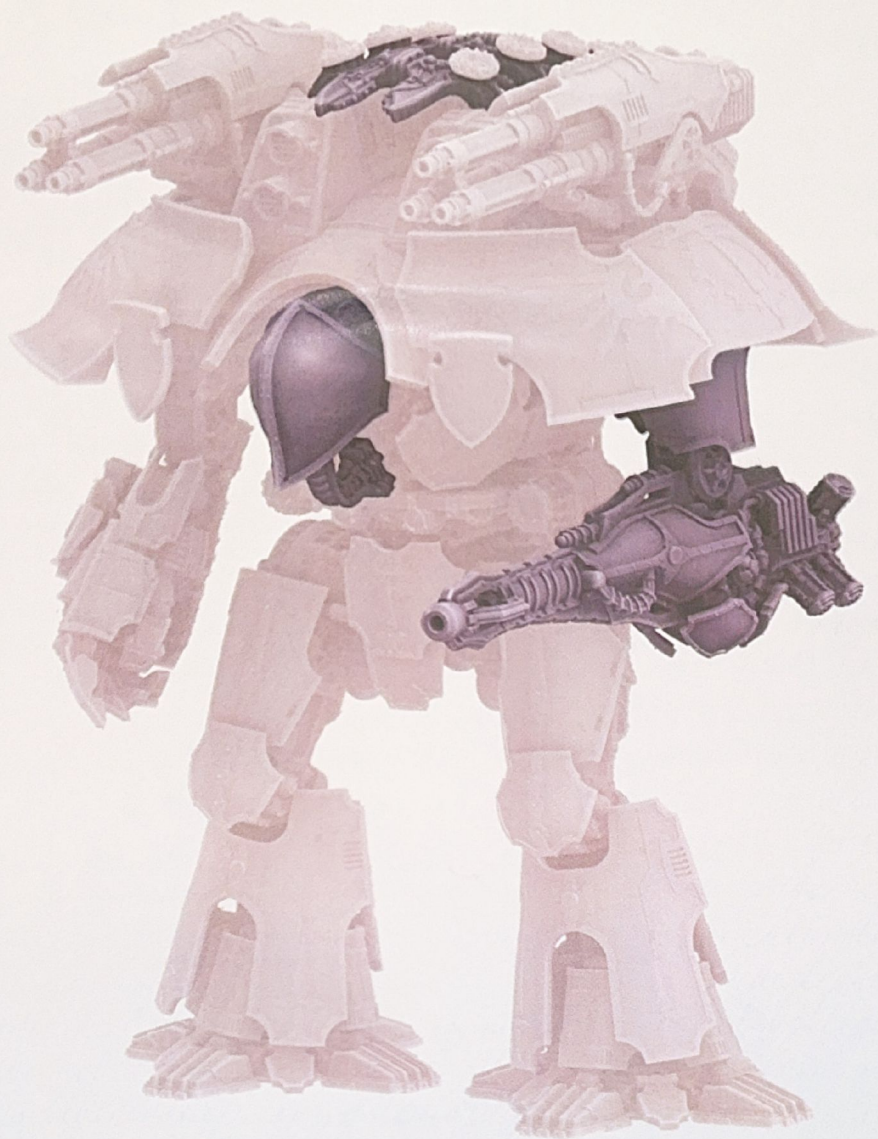

THIS IS NOT A TOY

Not suitable for children under 15 years of age.

WARNING: Resin dust can be harmful if inhaled. Always wear a dust mask or respirator when sanding or sawing resin parts.



993203990042

Forge World®



1

CIRICRUX ANIMA CONSTRUCTION

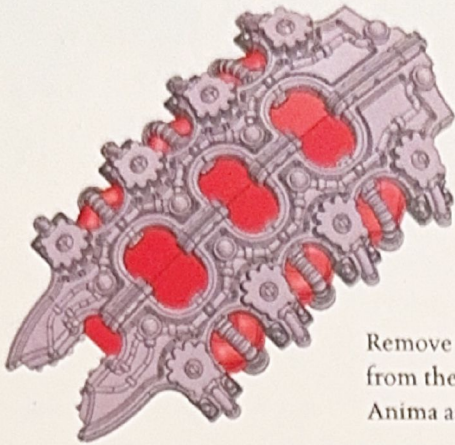

Remove the shims from the Ciricrux Anima as indicated.

2

Void Shield Projectors (Plastic Components)

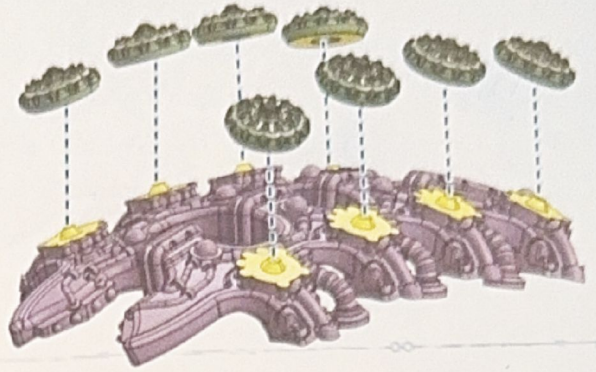

3

Ciricrux Anima Assembly

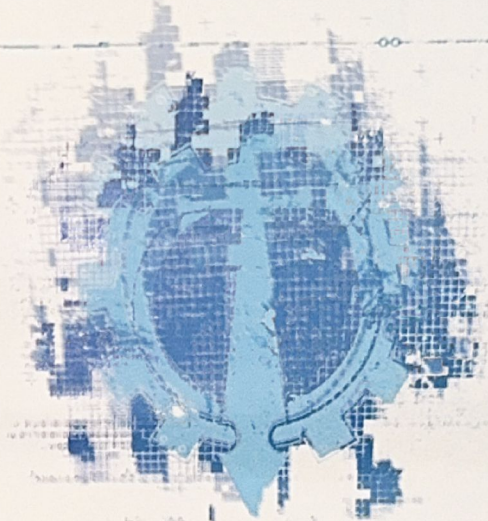
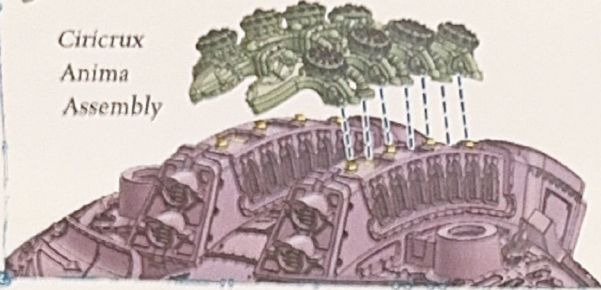

4

SINISTRAMANUS TENEBRAE CONSTRUCTION

Remove the shims from the Sinistramanus Tenebrae as indicated.

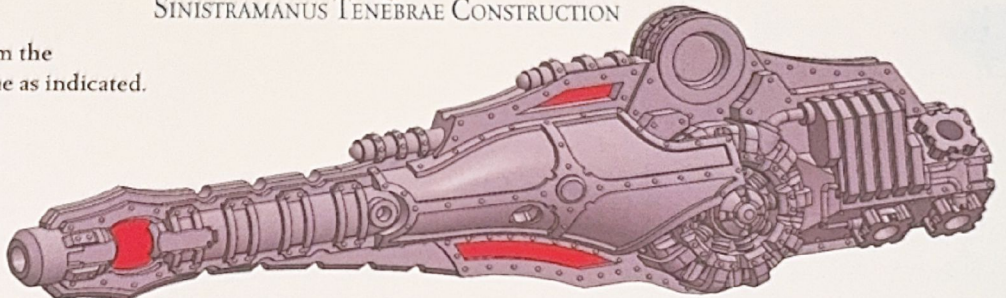

5

Barrel Vane

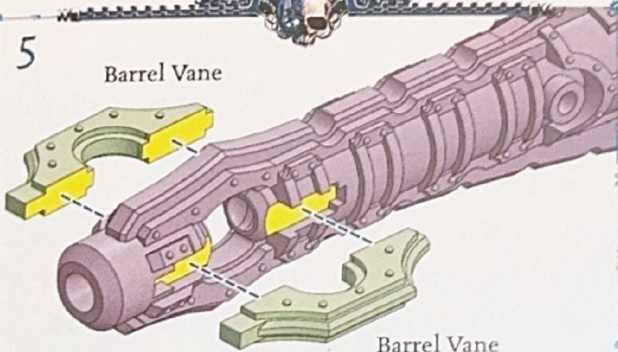

Barrel Vane

6

Warp Field Stabiliser

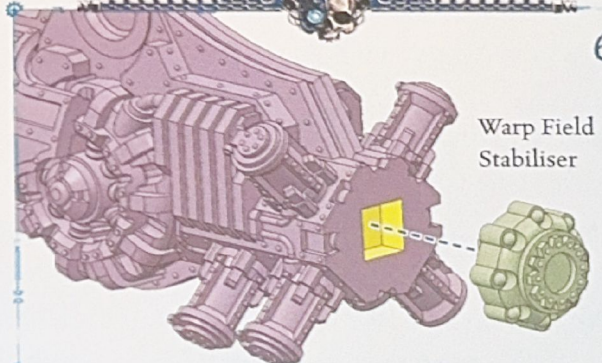

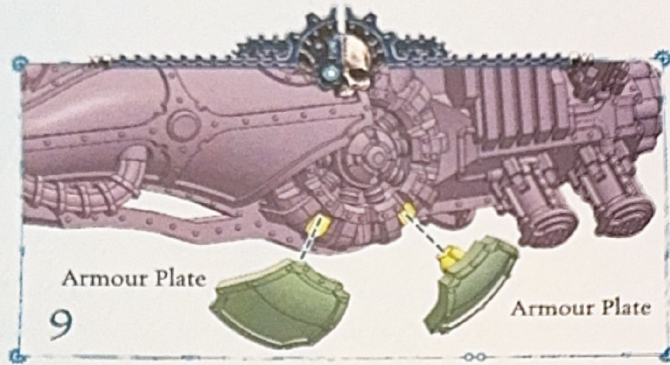
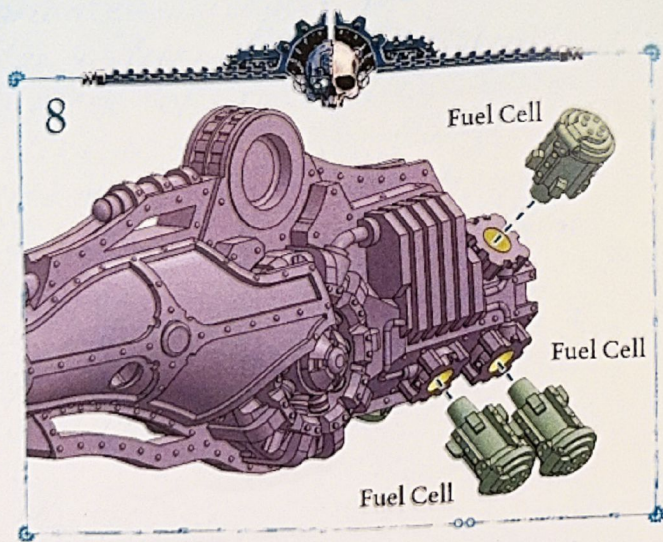
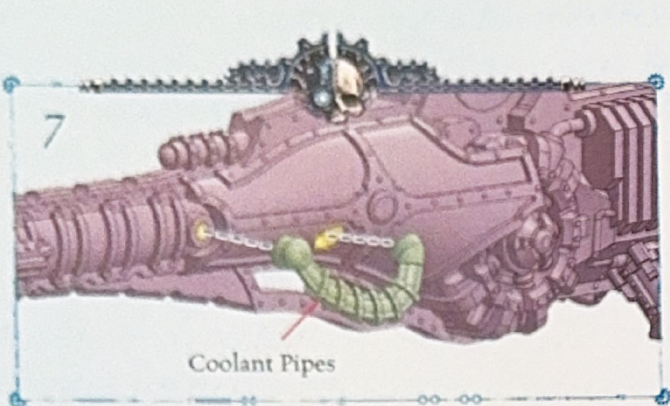

Repeat stages 7 - 9 for the Coolant Pipes, Fuel Cells and Armour Plates on the right side of the Sinistramanus Tenebrae

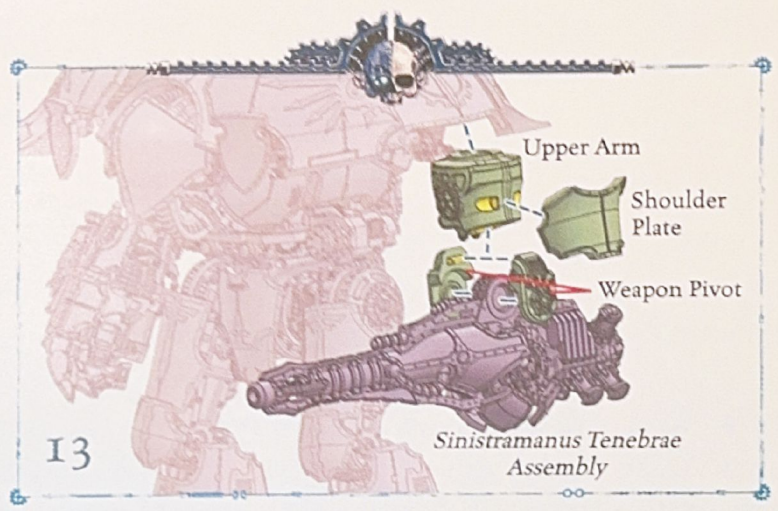
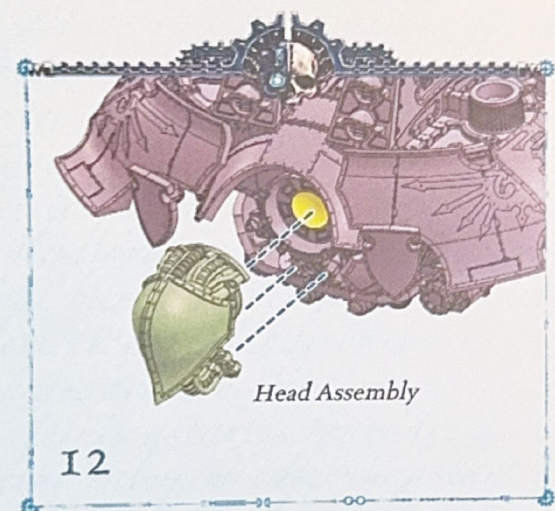
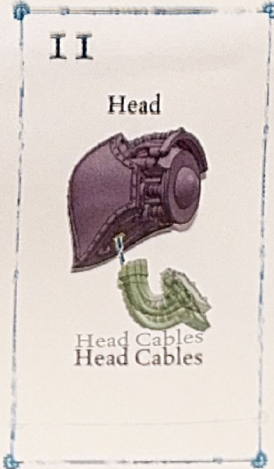
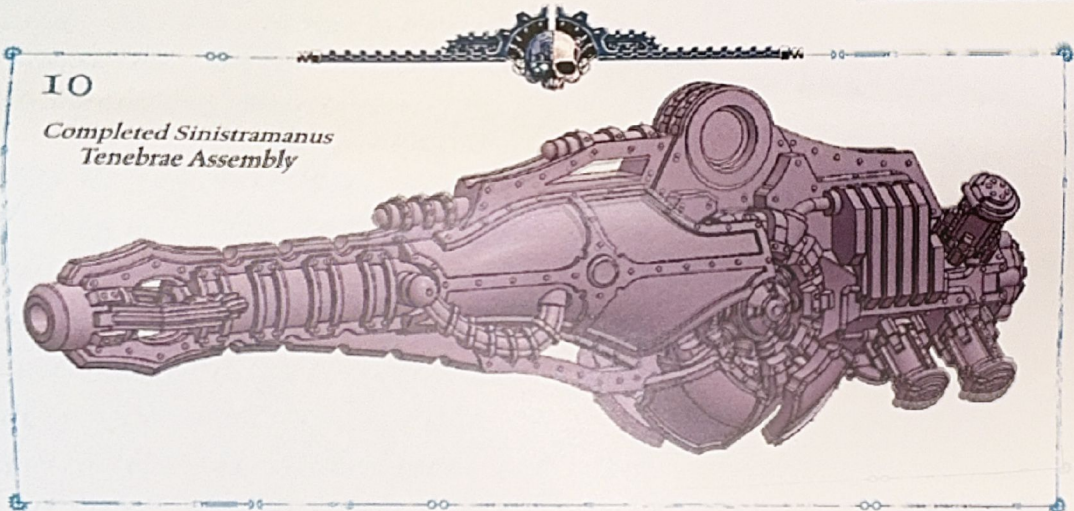



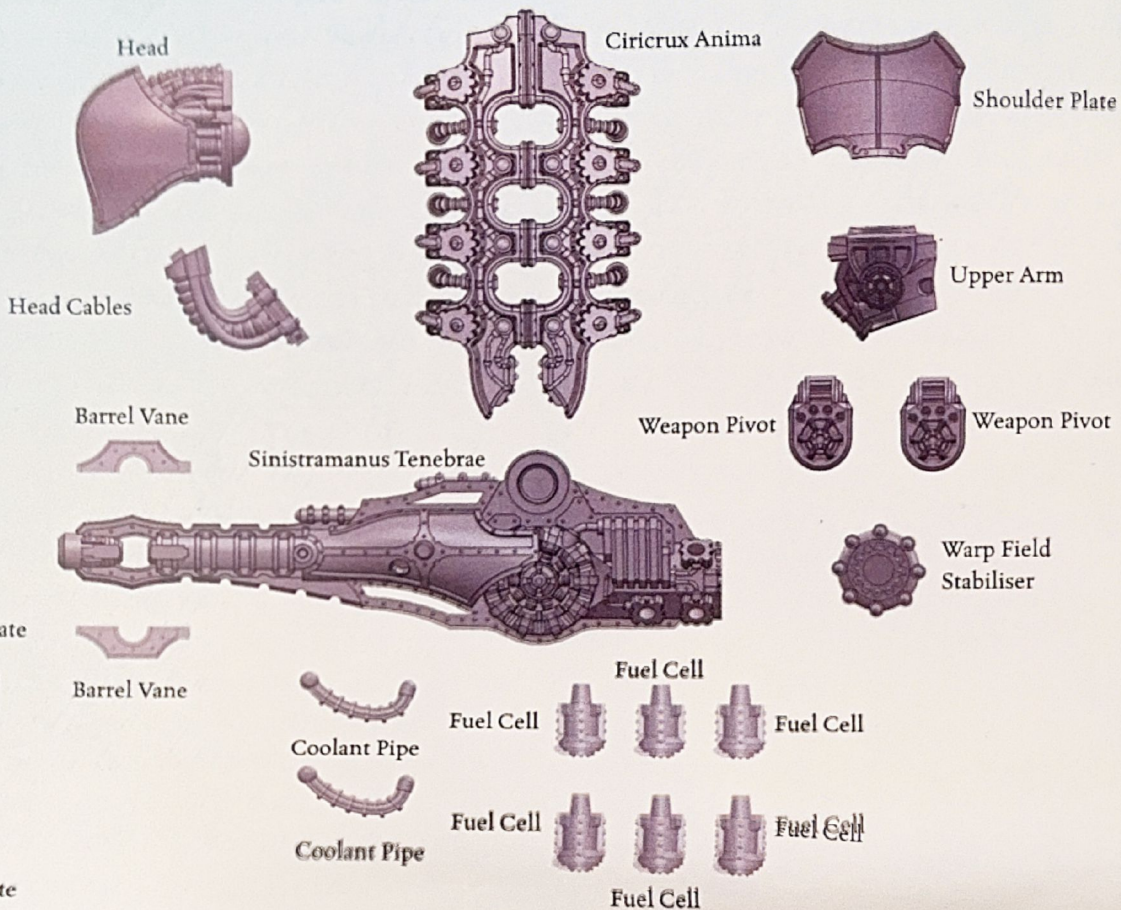

Components

Before assembly, check that none of the components are missing.

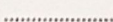

Assembly Legend

Parts for Assembly	
Glue Contact Area	
Shim for Removal	
Insert	
Component Highlight	

Preparing the Model for Assembly

Before assembling the model, wash each part thoroughly with an abrasive brush, such as a toothbrush, to remove any model release agent that may still be on the surface of the parts. Then, remove any excess resin such as mould lines, casting gates, vents and shims. For a more detailed guide to working with resin models, go to the Downloads section of the Forge World website.

This kit contains all the pieces required to construct a Warlord Sinister Psi-Titan. To glue the resin pieces together, use Citadel Super Glue.

NOTE: We have cast this kit using the most advanced techniques and the best quality resin, but due to the nature of the casting process, your model may contain small air bubbles. These can be filled with model filler or super glue. Any slight warpage of thin parts can easily be corrected by immersing the part in hot water for about 1 minute, then carefully bending it back into shape.

If you need to contact the Forge World Customer Service team regarding this model, you can get in touch via email – forgeworld@gwplc.com – or call:
 0115 900 4995 within the UK
 011 44 115 900 4995 from the USA and Canada
 0011 44 115 900 4995 from Australia
 011 44 115 900 4995 from Europe and the rest of the world.