

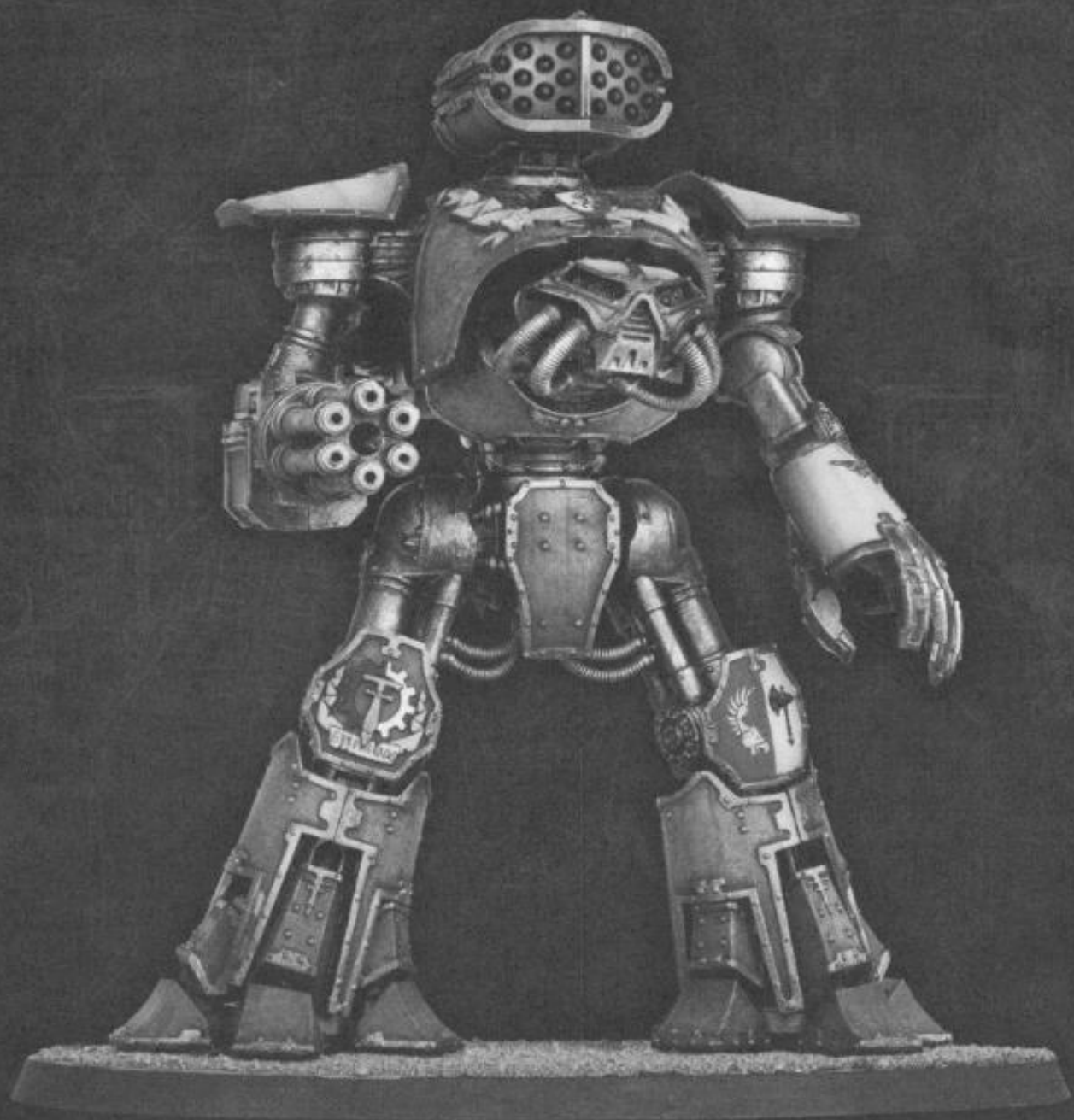

Free Downloads of Build Instructions,
Assembly Booklets & How To Guides

BuildInstructions.com

ADEPTUS TITANICUS™



REAVER BATTLE TITAN

CITADEL

© Copyright 2018, Games Workshop Ltd. All rights reserved.



993203990028

ADEPTUS TITANICUS™

REAVER BATTLE TITAN

EXPLANATION OF SYMBOLS • EXPLICATION DES SYMBOLES • EXPLICACIÓN DE SIMBOLOS • ERLÄUTERUNG DER SYMBOLE • LEGENDA DEI SIMBOLI • 符号説明 • 記号の説明



Special instruction - Please read
 Instructions spéciales - Lire attentivement
 Instrucción especial - Por favor, lea
 Besondere Anweisung - Bitte lesen
 Istruzioni speciali - Legga attentamente
 特別説明 - 請認真閱讀
 特別な指示 - 必ずお読みください



Stage complete
 Étape terminée
 Paso completado
 Schritt abgeschlossen
 Fase completa
 部件组装完成
 完了



Dry fit stage before gluing
 Tester avant de coller
 Comprobar el encaje antes de pegar
 Positionierung erst ohne Klebstoff ausprobieren
 Prova a secco prima di incollare
 使用胶水粘接前进行假组
 接着前に組み合わせる



Variant assembly
 Variante d'assemblage
 Variante de montage
 Bauvariante
 Assemblaggio alternativo
 多种组装方案
 組み立てのバリエーション



Repeat process
 Répéter l'étape
 Repetir pasos
 Vorgang wiederholen
 Ripeti il processo
 重复步骤
 手順を繰り返す



READ THIS FIRST: Before assembling your model kit, please read through the instructions in this booklet carefully. A pair of plastic cutters is required to remove the plastic components in this kit from their frame. We advise using a mouldline scraping tool to clean up the parts. To assemble your model, you will need plastic glue. Games Workshop sells Citadel Fine Detail Cutters, Citadel Mouldline Remover and Citadel Plastic Glue, but does not recommend these products for use by children under the age of 16 without adult supervision.

À LIRE EN PREMIER : Avant de vous lancer dans l'assemblage de ce kit, veuillez lire attentivement les instructions de ce livret. Une pince coupante est requise pour détacher chaque élément de sa grappe. Nous vous recommandons l'utilisation d'un grattoir pour ébarber les éléments. Pour l'assemblage, vous aurez également besoin de colle plastique. Games Workshop commercialise les Pinces de Précision Citadel, l'Ébarboir Citadel et la Colle Plastique Citadel, mais n'en recommande pas l'utilisation pour des enfants de moins de 16 ans sans la supervision d'un adulte.

LEER ANTES DE MONTAR: Antes de montar el contenido de este kit, lee estas instrucciones cuidadosamente. Te harán falta unas tenazas para plástico a fin de separar las piezas de la matriz. También aconsejamos una herramienta para rebabas a fin de limpiar cada pieza. Para montar la miniatura necesitarás pegamento para plástico. Games Workshop vende Tenazas Citadel, Herramientas para rebabas Citadel y Pegamento para plástico Citadel, pero no recomienda estos productos a menores de 16 años sin la supervisión de un adulto.

LIES DIES ZUERST: Bitte lies diese Anleitung sorgfältig, bevor du mit dem Zusammenbau deines Modells beginnst. Du benötigst einen Kunststoffseitenschneider, um die Kunststoffbauteile aus dem Gussrahmen herauszutrennen, und Kunststoffkleber, um die Miniatur zusammenzubauen. Außerdem empfehlen wir, die Bauteile vorher mit einem Gussgratentferner zu säubern. Games Workshop bietet Präzisions-Kunststoffseitenschneider von Citadel sowie Citadel-Kunststoffkleber an, empfiehlt aber, dass Kinder unter 16 Jahren diese nur unter Aufsicht eines Erwachsenen benutzen.

LEGGI PRIMA QUESTO: prima di assemblare il tuo modello, leggi le istruzioni di questo libretto con attenzione. Sono necessarie un paio di tronchesine per plastica per staccare i componenti dal loro sprus. Consigliamo di usare un attrezzo apposito per pulire i componenti. Per assemblare il modello avrai bisogno di colla per plastica. Games Workshop vende Tronchesine di precisione Citadel, Attrezzo per ripulire Citadel e Colla per plastica Citadel, ma non consiglia questi prodotti ad un pubblico minore di 16 anni senza la supervisione di un adulto.

优先阅读: 组装模型前, 请先仔细阅读本手册中的说明。需要用到模型剪钳将塑料部件从板件上取下。我们推荐使用合模线清理工具来清理零件。用塑料粘接剂来组装模型。Games Workshop 销售 Citadel 精密剪钳、Citadel 合模线刮刀和 Citadel 塑料粘接剂, 但不建议未满 16 岁的儿童在没有成人的监护下使用此类产品。

最初にお読みください: ミニチュアを組み立てる前に、この冊子の説明をよくお読みください。本セット内フレームからプラスチックパーツを切り取るためにプラスチック用ニッパーが必要となります。その後パーツを整形するため、モールドラインを削るためのツールの使用を推奨します。モデルの組み立てには、プラスチック接着剤が必要となります。ゲームワークショップでは「シタデルファインディテールニッパー」「シタデルモールドラインリムーバー」「シタデルプラスチック接着剤」を販売していますが、これらは保護者の監督なしでの16歳以下のお子様の使用を推奨しません。

16+



- Citadel plastic glue
- Colle plastique Citadel
- Pegamento para plástico
- Citadel-Kunststoffkleber
- Colla per plastica Citadel
- Citadel 塑料粘接剂
- シタデルプラスチック接着剤汎用しみみタイプ



- Citadel fine detail cutters
- Pinces de précision Citadel
- Tenazas Citadel
- Citadel-Seitenschneider
- Tronchesine di precisione Citadel
- Citadel 精密剪钳
- シタデルファインディテールニッパー



- Citadel mouldline remover
- Ébarboir Citadel
- Herramienta para rebabas Citadel
- Gussgratentferner
- Attrezzo per ripulire Citadel
- Citadel 合模线刮刀
- シタデルモールドラインリムーバー

- This kit can be assembled in a variety of ways. The angle at which the Titan's limbs can be posed is increased if you leave off the cables numbered A12, A13, C26, C28, C1, C35, C44, C2.
- Ce kit peut être assemblé de diverses façons. L'angle dans lequel les membres du Titan peuvent être positionnés sera augmenté si vous retirez les câbles A12, A13, C26, C28, C1, C35, C44, C2.
- Esta miniatura puede montarse de diferentes maneras. No usar los cables (piezas A12, A13, C26, C28, C1, C35, C44 y C2) facilita una mayor variedad de poses de las extremidades.
- Dieser Bausatz kann auf verschiedene Weisen zusammengebaut werden. Für größeren Spielraum bei der Positionierung der Gliedmaßen kannst du die Kabel mit den Nummern A12, A13, C26, C28, C1, C35, C44, C2 weglassen.
- Questo kit può essere assemblato in diversi modi. Per avere più varietà di posizionamento degli arti non incollare i cavi A12, A13, C26, C28, C1, C35, C44, C2.
- 本套件有多种组装方式。如果不使用编号为 A12、A13、C26、C28、C1、C35、C44、C2 的线缆，泰坦手臂的开会角度将更大。
- このキットは、さまざまな方法で組み立てることができます。A12、A13、C26、C28、C1、C35、C44、C2という番号のケーブルを接着せずに組み立てると、タイタンが四肢を広げた姿勢にできます。

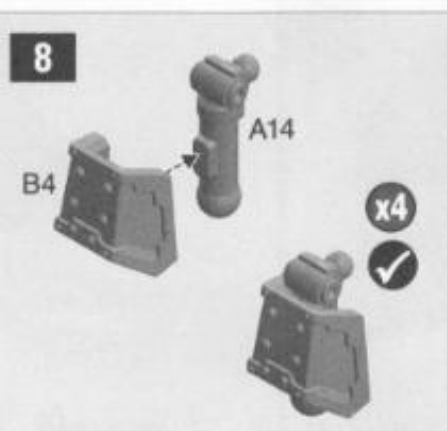
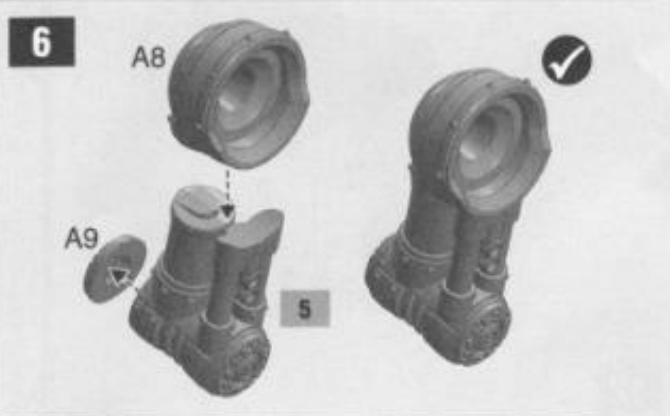
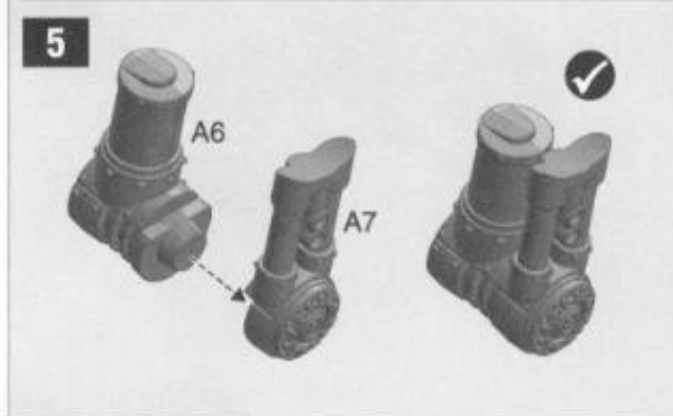
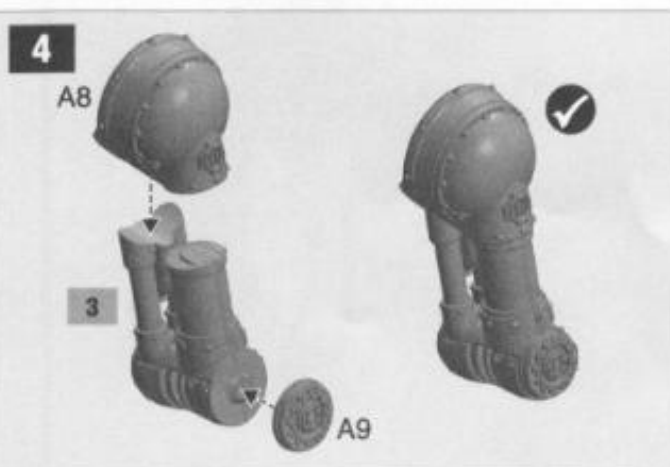
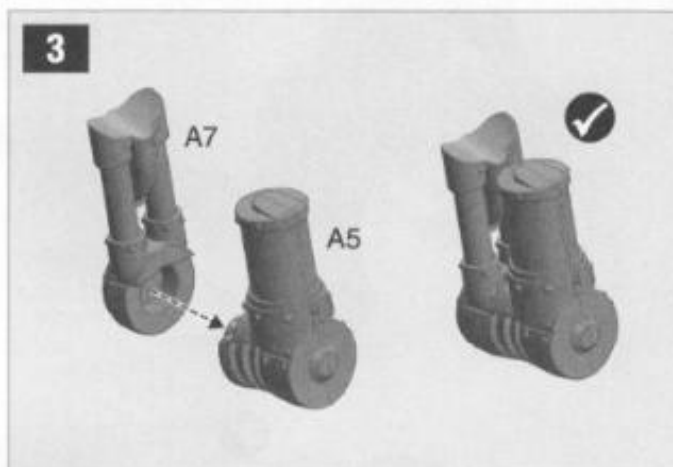
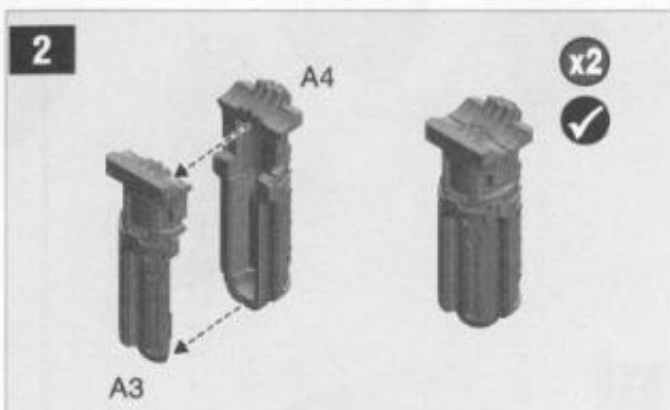
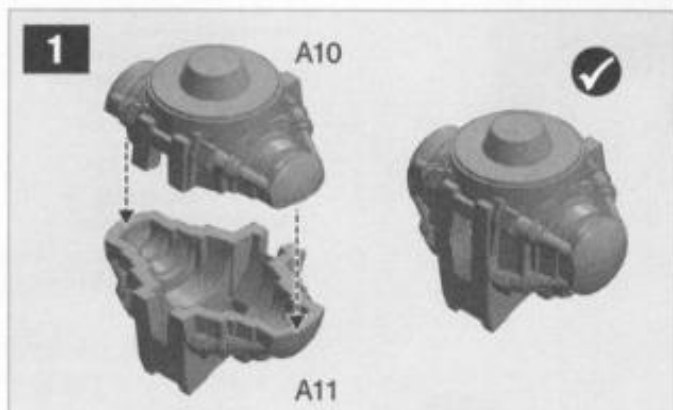

10

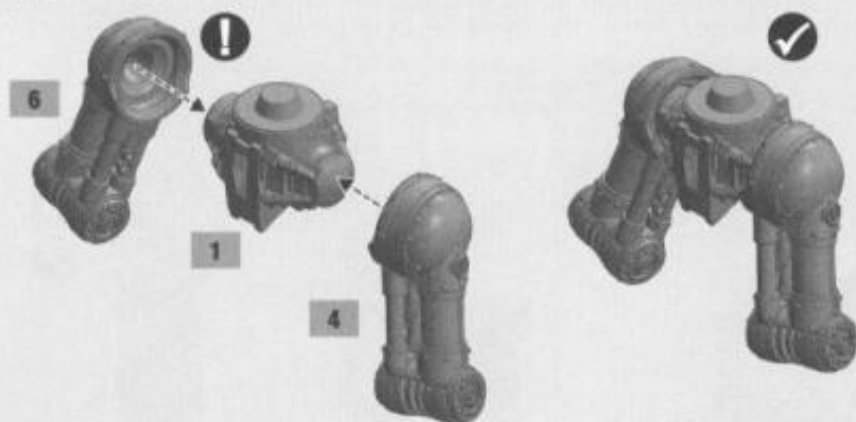

! You may choose to build the legs first, to allow for easier posing.

- Vous pouvez choisir d'assembler les jambes en premier, pour plus de latitude de poses.
- Puedes montar las piernas primero para crear la pose que deseas más fácilmente.
- Zur einfacheren Positionierung können die Beine zuerst gebaut werden.
- Puoi scegliere di assemblare prima le gambe, per posizionarlo meglio.
- 您可以选择先组装腿部，从而轻松摆出造型。
- 足を最初に組み立てると、ポーズをつけるのが簡単になります。

11

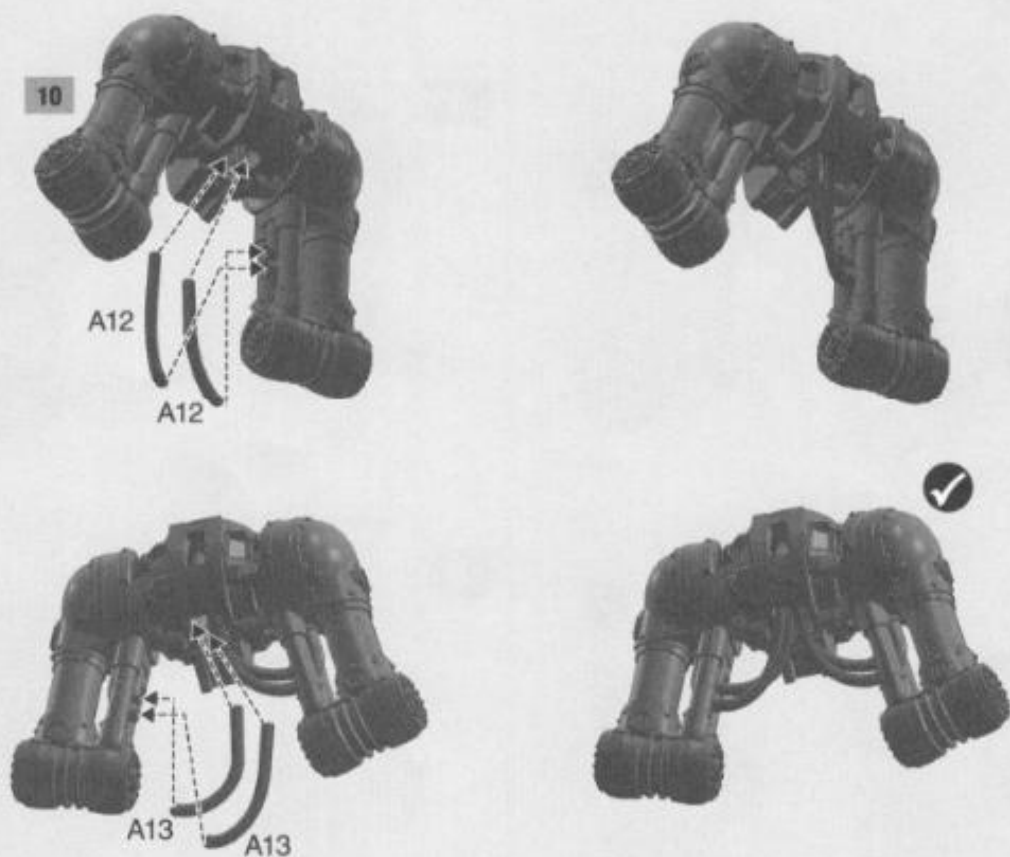

12

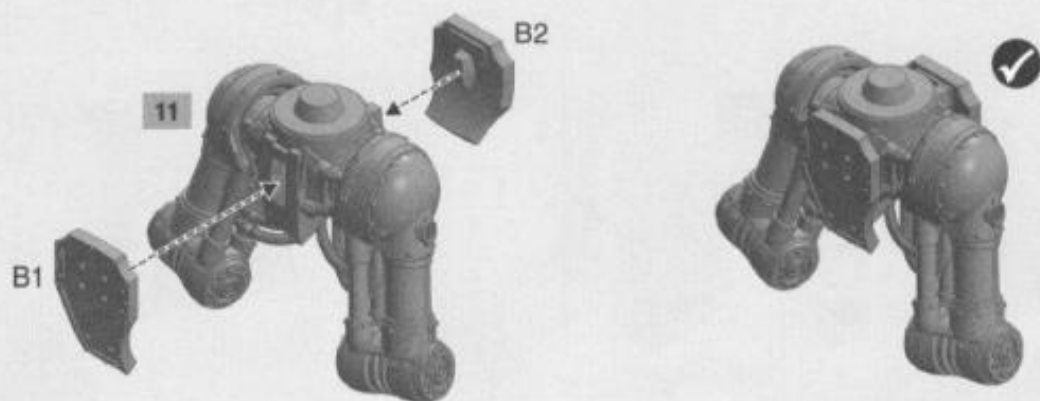

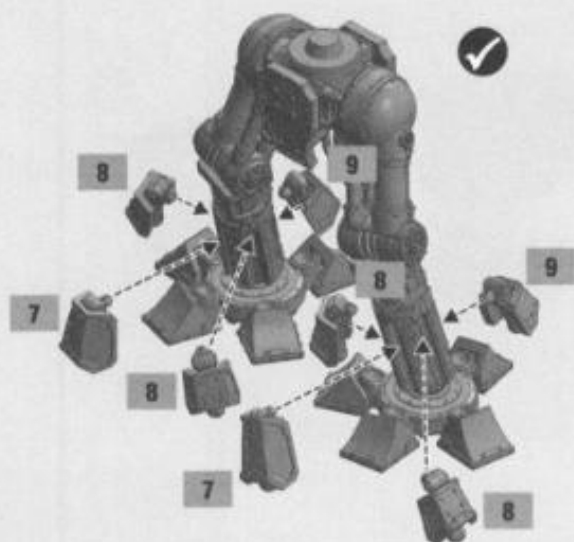
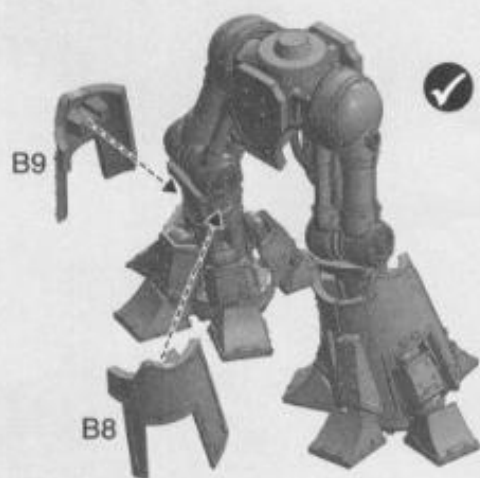
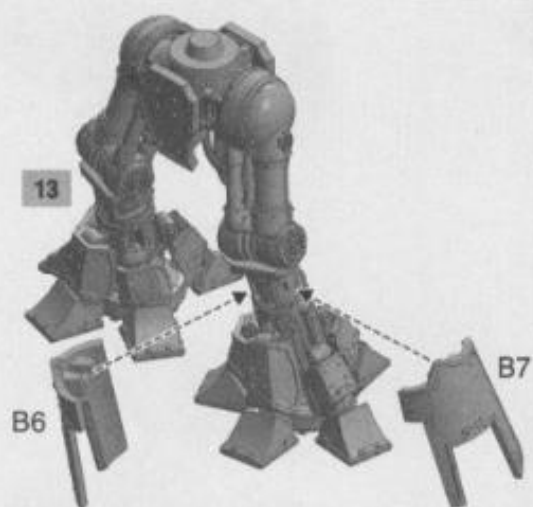
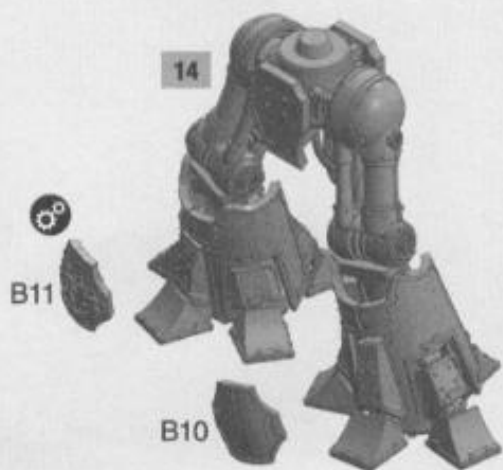
13**14****15**

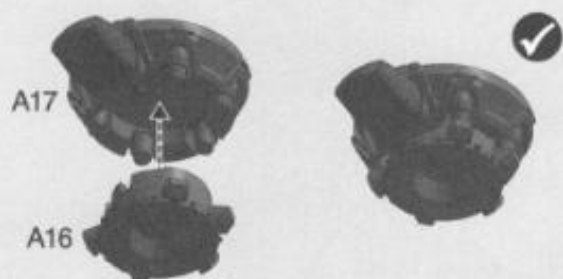
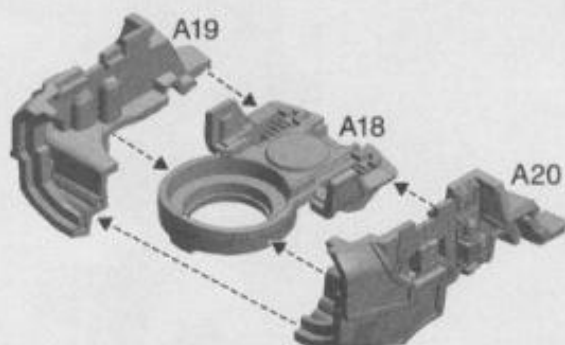
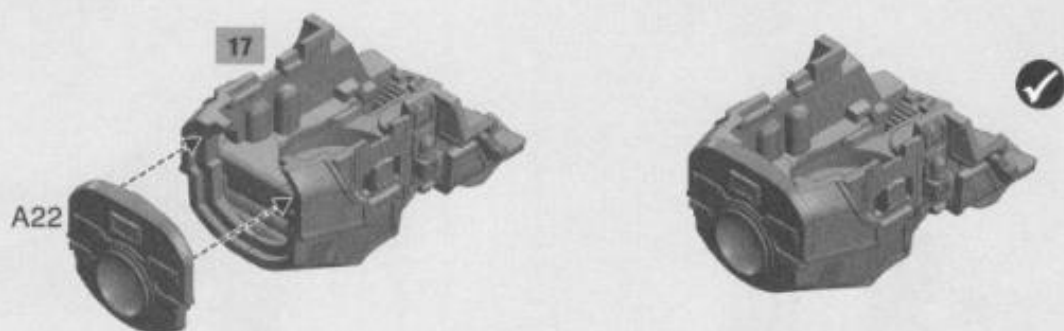
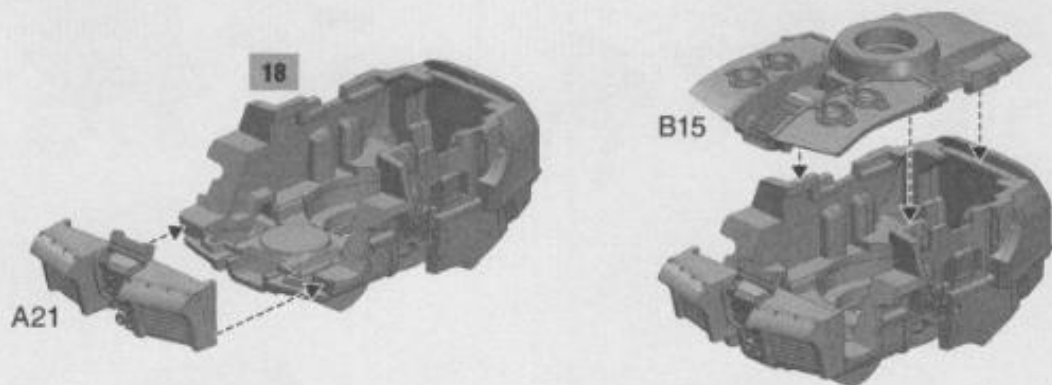
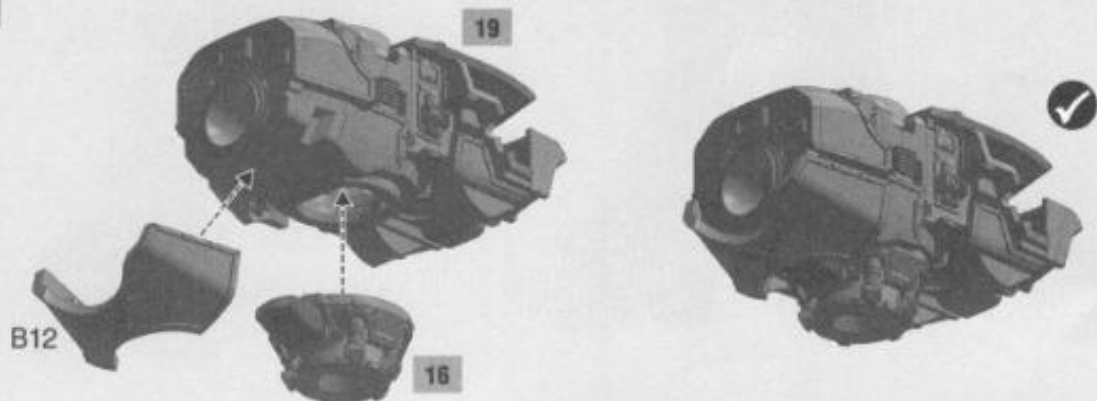
16**17****18****19****20**

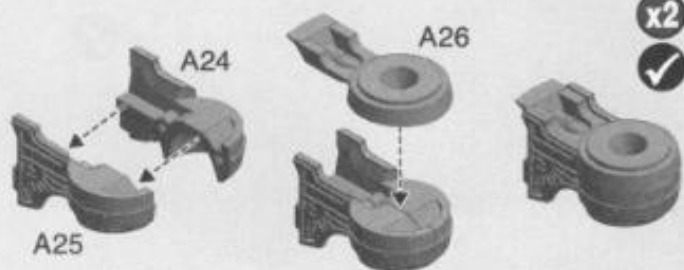
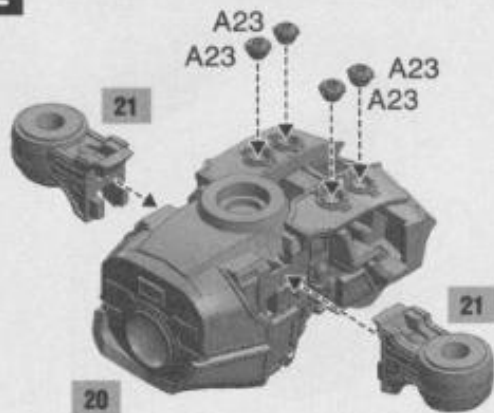
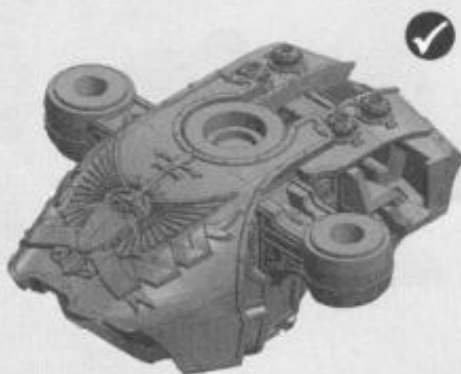
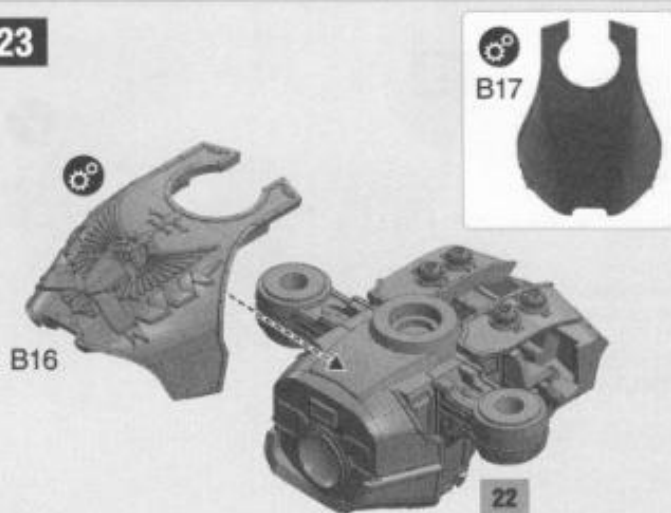
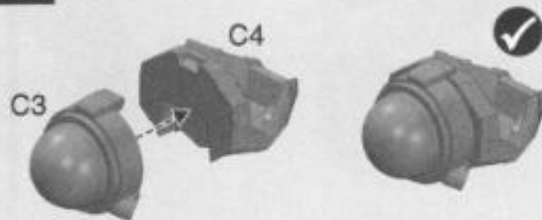
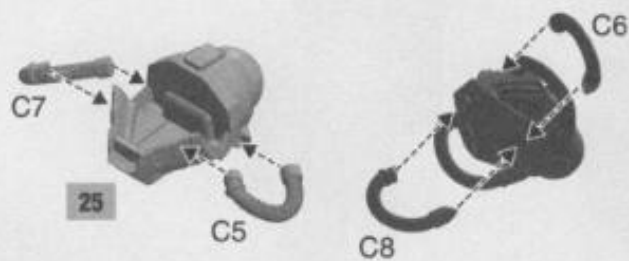
21**22****23****24****25****26**

27 APOCALYPSE MISSILE LAUNCHER



28 REAVER TITAN POWER FIST



- ! • See step 47-50 for alternative assembly.
 • Voir les étapes 47-50 pour un assemblage différent.
 • Consulta los pasos 47-50 para una variante de montaje.
 • Alternativer Zusammenbau siehe Schritt 47-50.
 • Vedi passi 47-50 per un assemblaggio alternativo.
 • 参见第 47-50 步了解备选的组装方案。
 • 別の組み立て方については、ステップ47-50を参照してください。

29

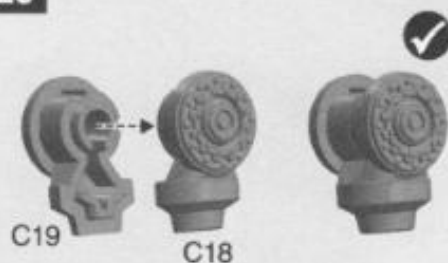

30

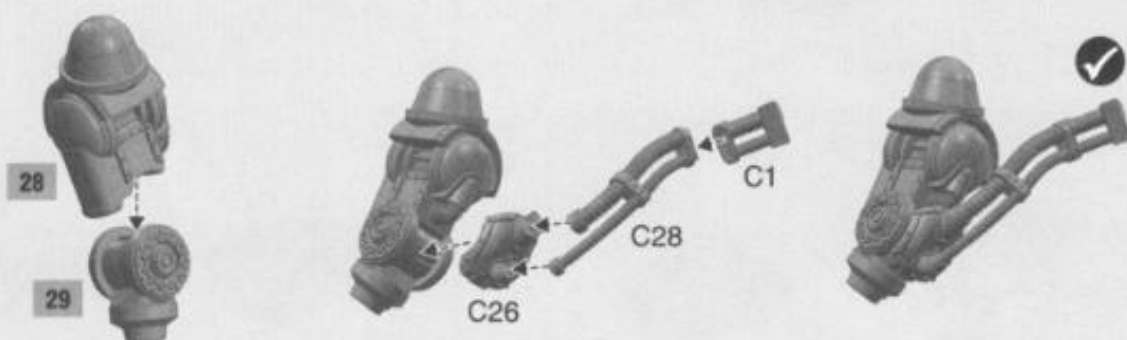

31

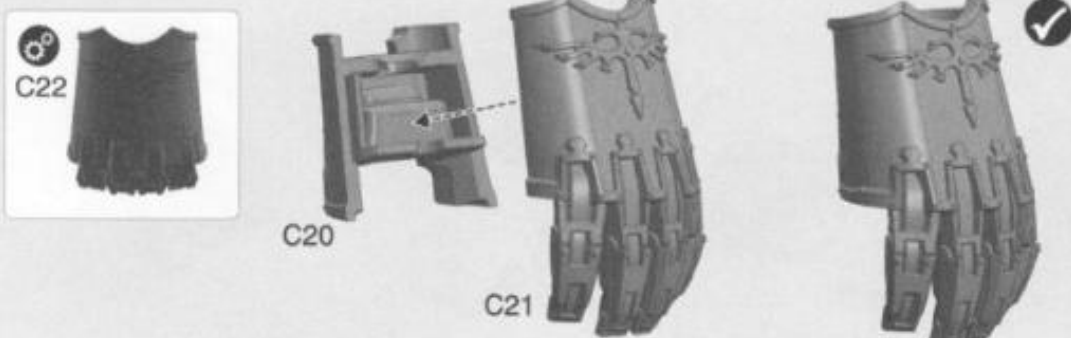

32

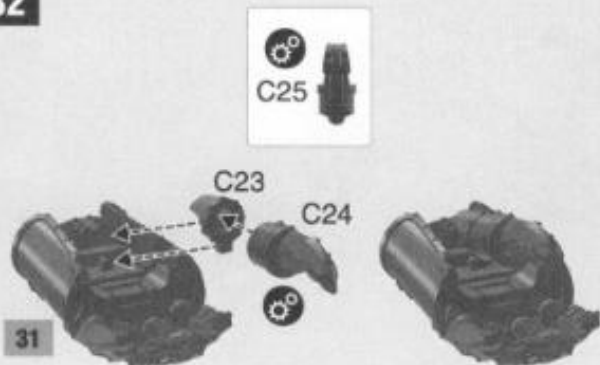

33

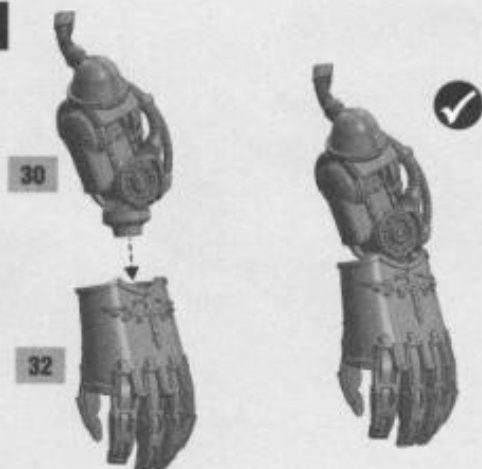

34 GATLING BLASTER

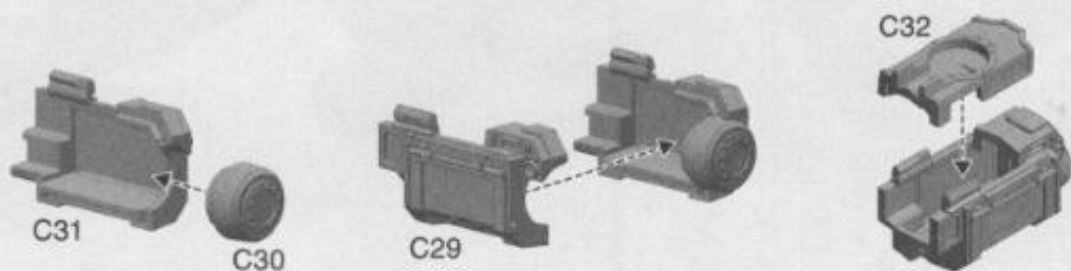

35

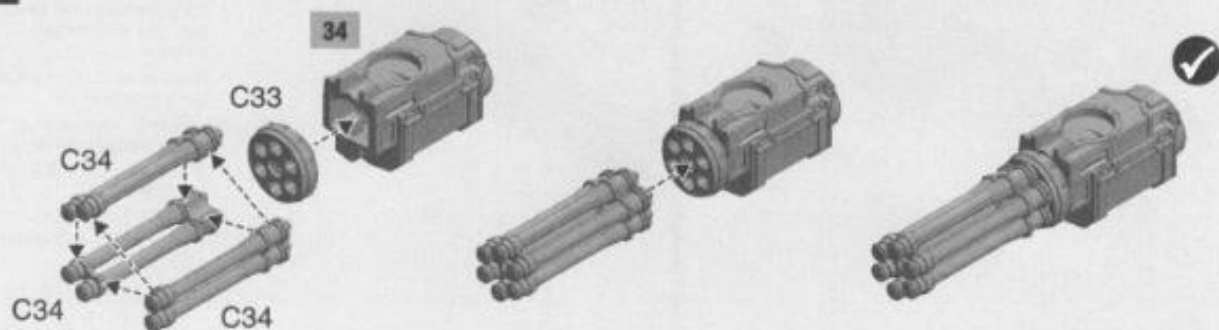

36

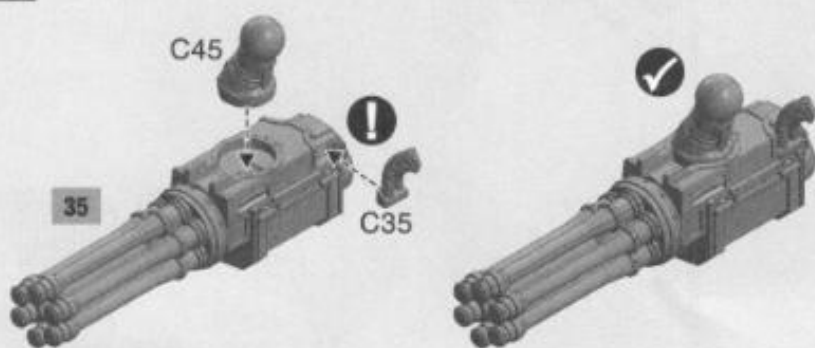

- I** • See step 44-46 for alternative assembly.
 • Voir les étapes 44-46 pour un assemblage différent.
- Consulta los pasos 44-46 para una variante de montaje.
 - Alternativer Zusammenbau siehe Schritt 44-46.
 - Vedi passi 44-46 per un assemblaggio alternativo.
 - 参见第 44-46 步了解备选的组装方案。
 - 別の組み立て方については、ステップ44-46を参照してください。

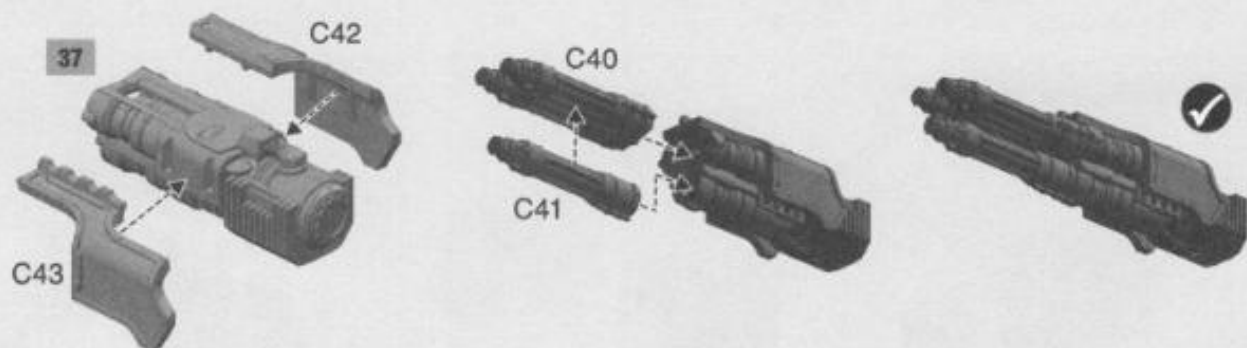
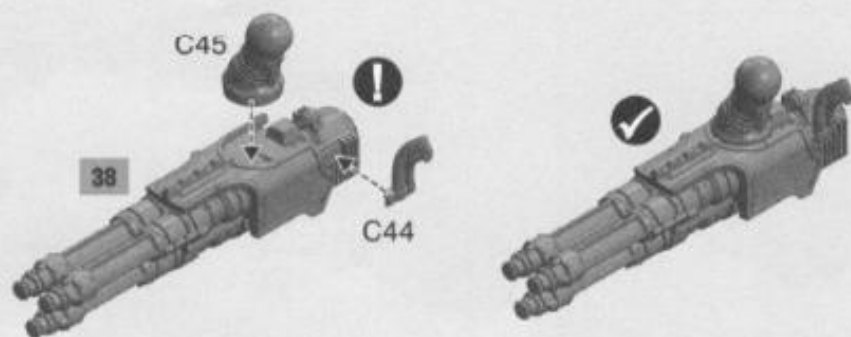
37 LASER BLASTER**38****39**

- !** • See step 44-46 for alternative assembly.
 • Voir les étapes 44-46 pour un assemblage différent.
 • Consulta los pasos 44-46 para una variante de montaje.
 • Alternativer Zusammenbau siehe Schritt 44-46.
 • Vedi passi 44-46 per un assemblaggio alternativo.
 • 参见第 44-46 步了解备选的组装方案。
 • 別の組み立て方については、ステップ44-46を参照してください。

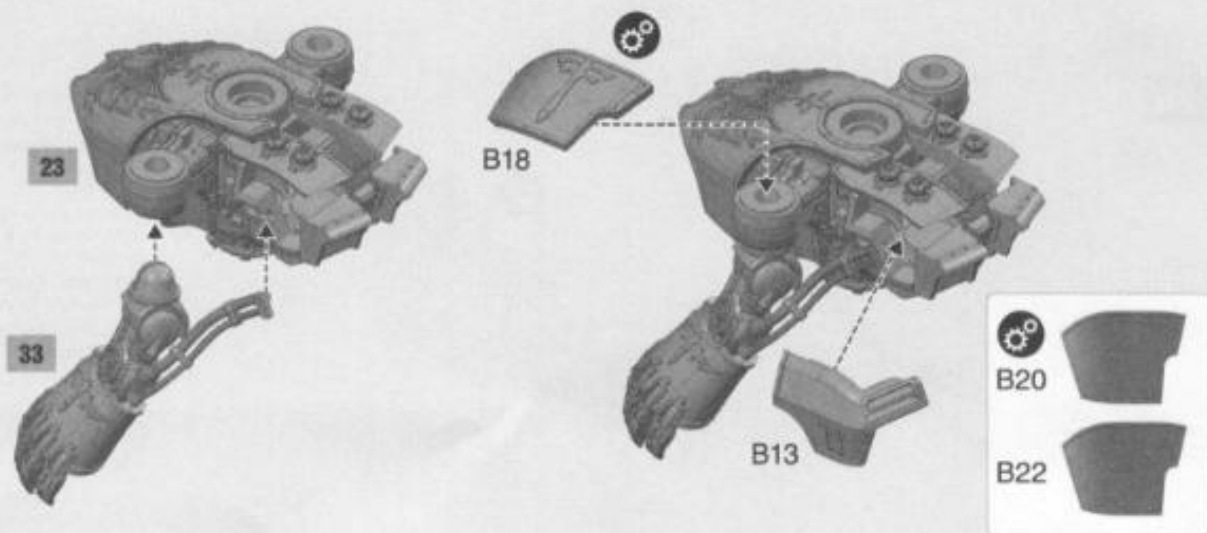
40

41

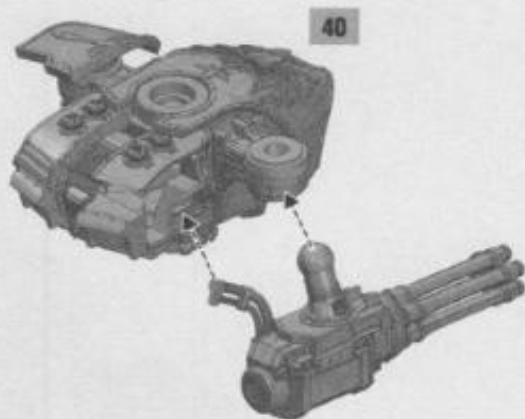

42

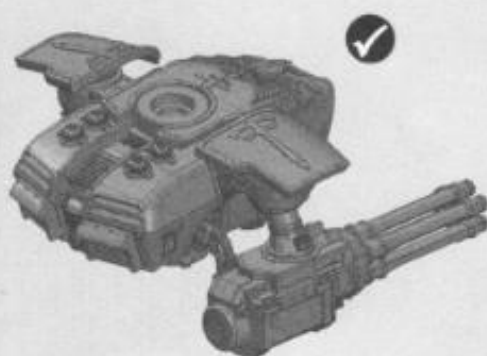
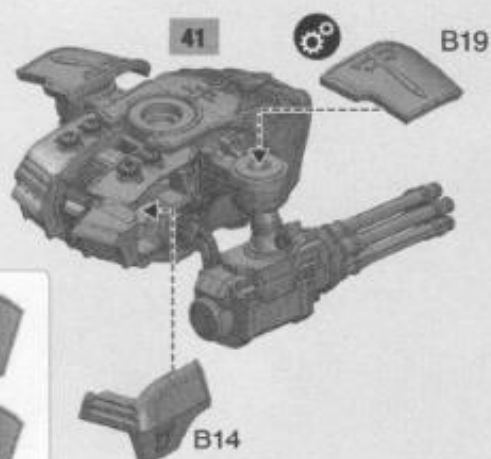

43

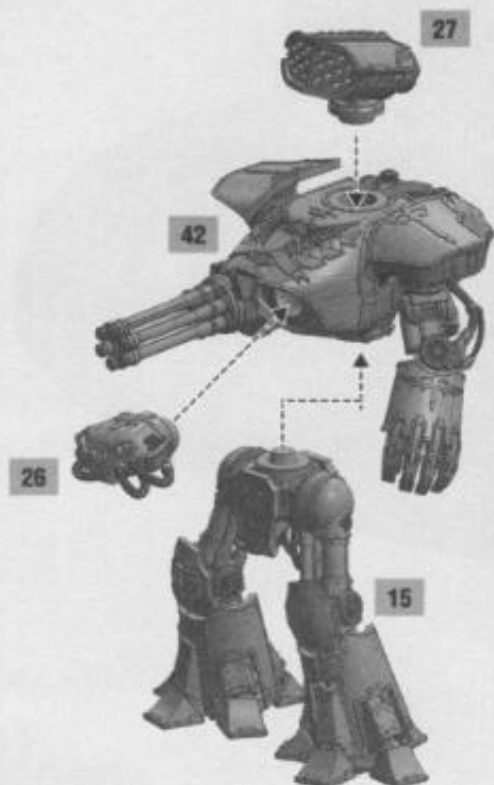

! The following steps provide optional assemblies for the Reaver's arms and weapon options. Using these steps will allow for alternative poses and weapon loadouts.

Les étapes suivantes permettent d'autres assemblages pour les bras et l'armement du Reaver. Suivre ces étapes vous autorisera des poses et un armement différents.

Los pasos siguientes muestran variantes de montaje de los brazos y de opciones de armas del Reaver. Síguelas si deseas crear diversas poses y configuraciones de armamento.

Die folgenden Schritte beschreiben Alternativen beim Zusammenbau der Arme und Waffenoptionen des Reavers, die weitere Posen und Waffenkombinationen ermöglichen.

I seguenti passi forniscono assemblaggi opzionali per le braccia e le scelte d'arma del Reaver. Seguendo questi passi potrai ottenere posizioni e configurazioni d'arma alternative.

下列步骤为掠夺者手臂和武器的备选组装方案。根据这些步骤，您可以搭配多种造型和武器配备。

次のステップでは、Reaverの腕と武器オプションの組み立て方を説明します。このステップ通りの組み立て手順を使用すると、違ったポーズと武器への変更が可能になります。

44



- !** Carefully remove highlighted parts.
- Retirer soigneusement les éléments surlignés.
- Corta cuidadosamente las partes señaladas.
- Hervorgehobene Teile sorgfältig entfernen.
- Rimuovi con cura i componenti evidenziati.
- 小心移除高亮的部件。
- ハイライトされた部分を注意深くカットします。

45

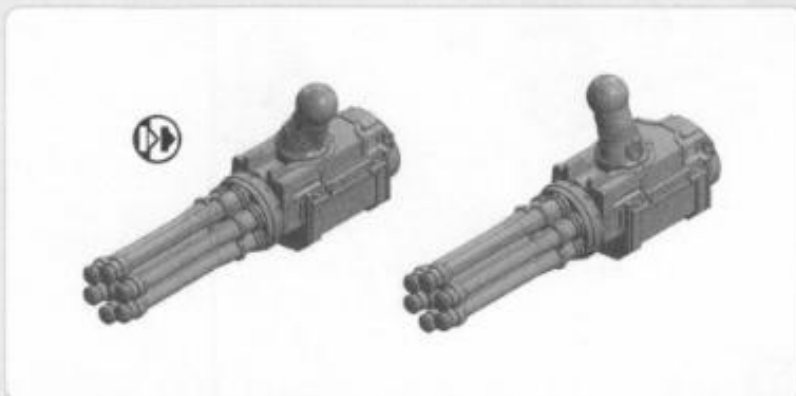

46

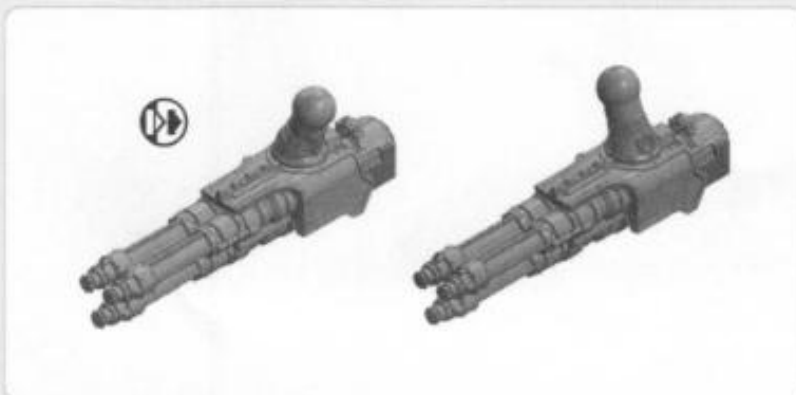

47

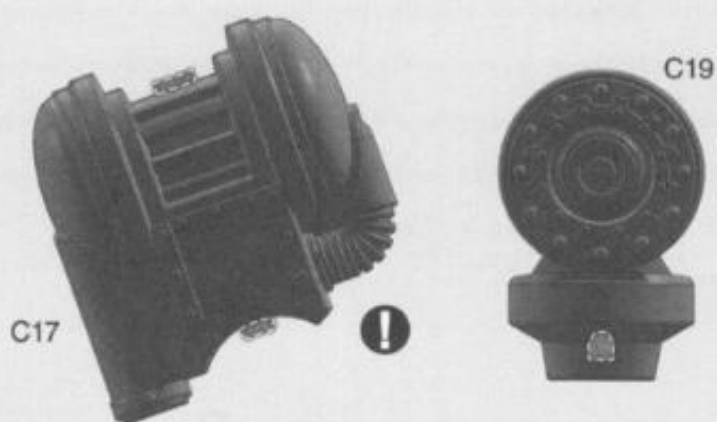

- !** Carefully remove highlighted parts.
- Retirer soigneusement les éléments surlignés.
- Corta cuidadosamente las partes señaladas.
 - Hervorgehobene Teile sorgfältig entfernen.
 - Rimuovi con cura i componenti evidenziati.
 - 小心移除高亮的部分。
 - ハイライトされた部分を注意深くカットします。

48

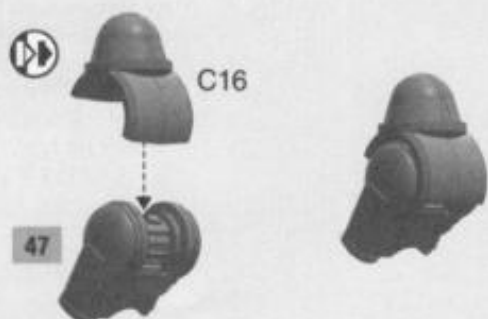

49

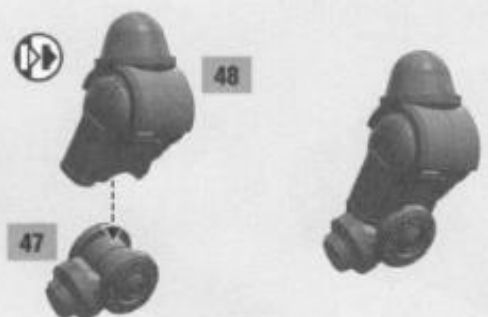

50

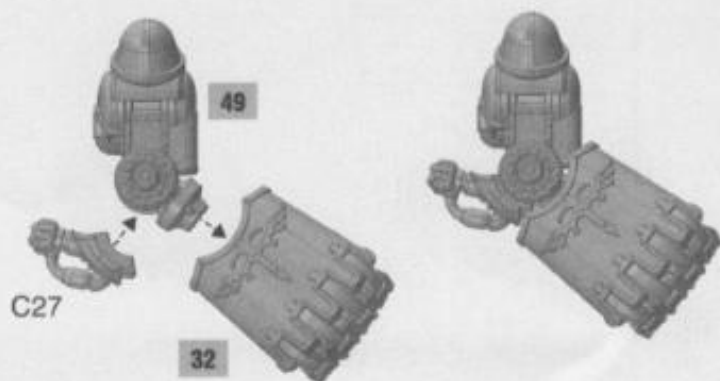





ADEPTUS TITANICUS™

