



Free Downloads of Build Instructions,
Assembly Booklets & How To Guides

BuildInstructions.com

ADEPTUS TITANICUS™



IMPERIAL CERASTUS KNIGHTS

CITADEL

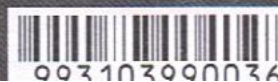

003103090034

ADEPTUS TITANICUS™

IMPERIAL CERASTUS KNIGHTS

EXPLANATION OF SYMBOLS • EXPLICATION DES SYMBOLES • EXPLICACIÓN DE SIMBOLOS • ERLÄUTERUNG DER SYMBOLE • LEGENDA DEI SIMBOLI • 符号说明 • 記号の説明

- | | | | | |
|---|---|---|---|---|
| <p>! Special instruction – Please read Instructions spéciales – Lire attentivement Instrucción especial – Por favor, lea Besondere Anweisung – Bitte lesen Istruzioni speciali – Leggi attentamente 特別说明 – 请认真阅读 特別な指示 – 必ずお読みください</p> | <p>✓ Stage complete Étape terminée Paso completado Schritt abgeschlossen Fase completa 部件组装完成 完了</p> | <p>▶ Dry fit stage before gluing Tester avant de coller Comprobar el encaje antes de pegar Positionierung erst ohne Klebeloff ausprobieren Prova a secco prima di incollare 使用胶水粘接前进行假组 接合前にフィット</p> | <p>⚙️ Variant assembly Variante d'assemblage Variante de montaje Bauvarianten Assemblaggio alternativo 多种组装方案 組み立てのバリエーション</p> | <p>x2 Repeat process Répéter l'étape Répéter pasos Vorgang wiederholen Ripeti il processo 重复步骤 プロセスを繰り返す</p> |
|---|---|---|---|---|

! **READ THIS FIRST:** Before assembling your model kit, please read through the instructions in this booklet carefully. A pair of plastic cutters is required to remove the plastic components in this kit from their frame. We advise using a mouldline scraping tool to clean up the parts. To assemble your model, you will need plastic glue. Games Workshop sells Citadel Fine Detail Cutters, Citadel Mouldline Remover and Citadel Plastic Glue, but does not recommend these products for use by children under the age of 16 without adult supervision.

À LIRE EN PREMIER : Avant de vous lancer dans l'assemblage de ce kit, veuillez lire attentivement les instructions de ce livret. Une pince coupante est requise pour détacher chaque élément de sa grappe. Nous vous recommandons l'utilisation d'un grattoir pour ébarber les éléments. Pour l'assemblage, vous aurez également besoin de colle plastique. Games Workshop commercialise les Pinces de Précision Citadel, l'Ébarboir Citadel et la Colle Plastique Citadel, mais n'en recommande pas l'utilisation pour des enfants de moins de 16 ans sans la supervision d'un adulte.

LEER ANTES DE MONTAR: Antes de montar el contenido de este kit, lee estas instrucciones cuidadosamente. Te harán falta unas tenazas para plástico a fin de separar las piezas de la matriz. También aconsejamos una herramienta para rebabas a fin de limpiar cada pieza. Para montar la miniatura necesitarás pegamento para plástico. Games Workshop vende Tenazas Citadel, Herramientas para rebabas Citadel y Pegamento para plástico Citadel, pero no recomienda estos productos a menores de 16 años sin la supervisión de un adulto.

LIES DIES ZUERST: Bitte lies diese Anleitung sorgfältig, bevor du mit dem Zusammenbau deines Modells beginnst. Du benötigst einen Kunststoffseitenschneider, um die Kunststoffbauteile aus dem Gussrahmen herauszutrennen, und Kunststoffkëber, um die Miniatur zusammenzubauen. Außerdem empfehlen wir, die Bauteile vorher mit einem Gussgratentferner zu säubern. Games Workshop bietet Präzisions-Kunststoffseitenschneider von Citadel sowie Citadel-Kunststoffkleber an, empfiehlt aber, dass Kinder unter 16 Jahren diese nur unter Aufsicht eines Erwachsenen benutzen.

LEGGI PRIMA QUESTO: prima di assemblare il tuo modello, leggi le istruzioni di questo libretto con attenzione. Sono necessarie un paio di tronchesine per plastica per staccare i componenti dai loro sprue. Consigliamo di usare un attrezzo apposito per pulire i componenti. Per assemblare il modello avrai bisogno di colla per plastica. Games Workshop vende Tronchesine di precisione Citadel, Attrezzo per ripulire Citadel e Colla per plastica Citadel, ma non consiglia questi prodotti ad un pubblico minore di 16 anni senza la supervisione di un adulto.

优先阅读：组装模型前，请先仔细阅读本手册中的说明。需要用模型剪钳将塑料部件从板件上剪下。我们推荐使用合模线清理工具来清理零件。用塑料粘接剂来组装模型。Games Workshop 销售 Citadel 精密剪钳、Citadel 合模线刮刀和 Citadel 塑料粘接剂，但不建议未满 16 岁的儿童在没有成人的监护下使用此类产品。

最初にお読みください：ミニチュアを組み立てる前に、この冊子の説明をよくお読みください。本セット内フレームからプラスチックパーツを切り取るためにプラスチック用ニッパーが必要となります。その後パーツを滑らかにするため、モールドラインを削るためのツールの使用を推奨します。モデルの組み立てには、プラスチック接着剤が必要となります。ゲームズワークショップでは『シタデルファインディテールニッパー』『シタデルモールドラインリムーバー』『シタデルプラスチック接着剤』を販売していますが、これらは保護者の監督なしでの16歳以下のお子様の使用を推奨しません。

16+



- Citadel plastic glue
- Colle plastique Citadel
- Pegamento para plástico
- Citadel-Kunststoffkleber
- Colla per plastica Citadel
- Citadel 塑料粘接剂
- シタデルプラスチック接着剤 流し込みタイプ



- Citadel fine detail cutters
- Pinces de précision Citadel
- Tenazas Citadel
- Citadel-Seitenschneider
- Tronchesine di precisione Citadel
- Citadel 精密剪钳
- シタデルファインディテールニッパー

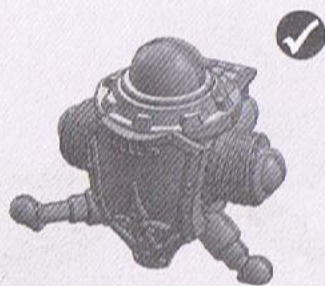
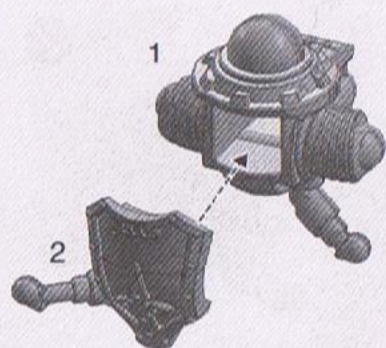
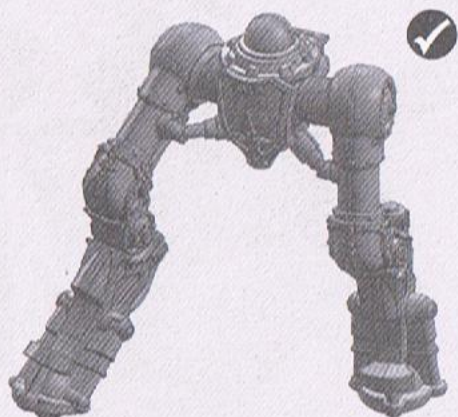
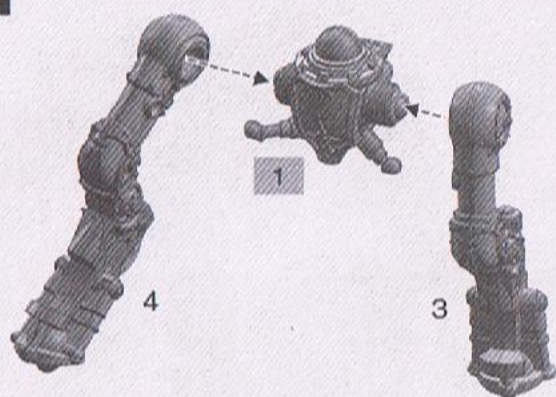
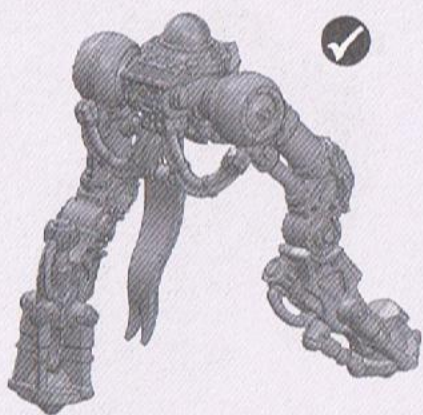
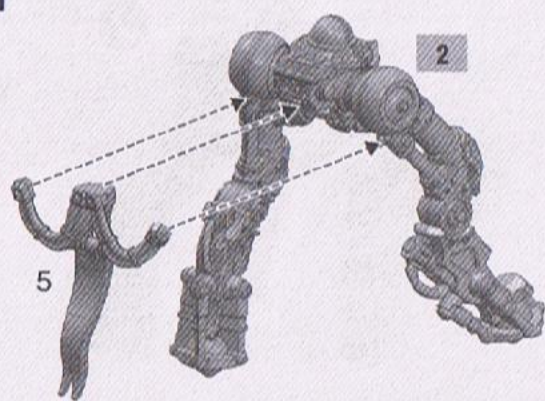
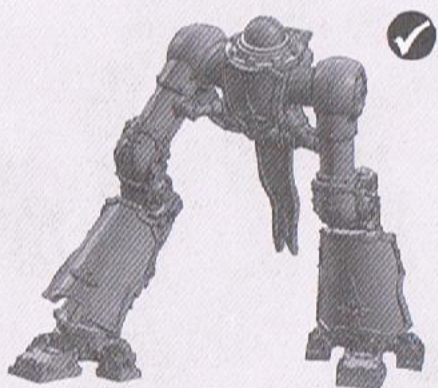
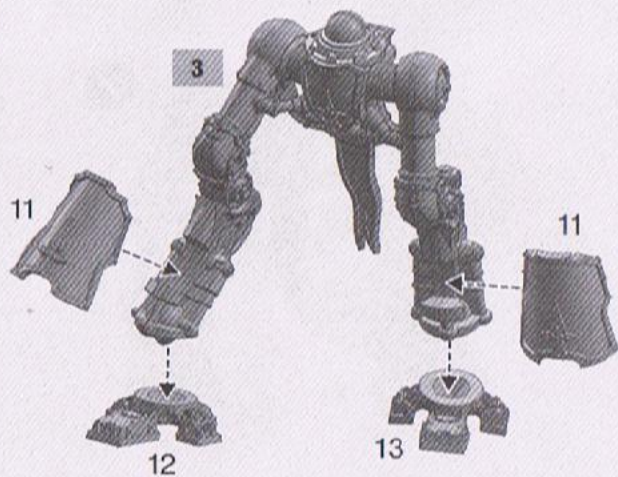

- Citadel mouldline remover
- Ébarboir Citadel
- Herramienta para rebabas Citadel
- Gussgratentferner
- Attrezzo per ripulire Citadel
- Citadel 合模线刮刀
- シタデルモールドラインリムーバー

1**2****3****4**

5

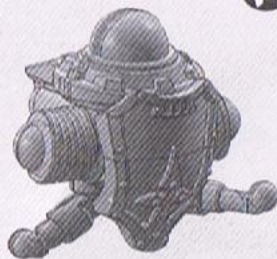
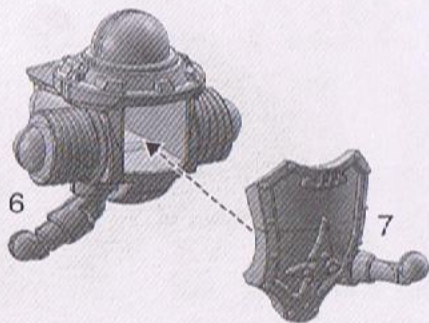

6

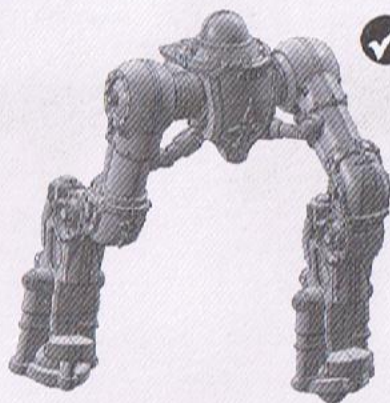
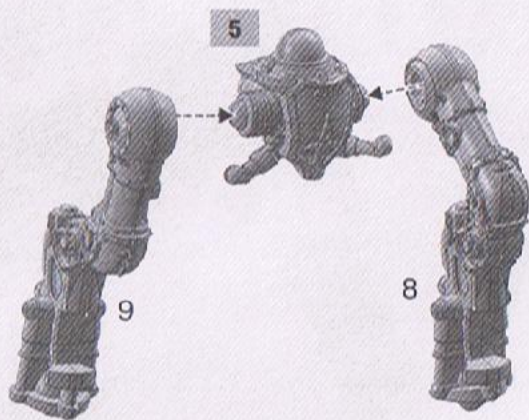

7

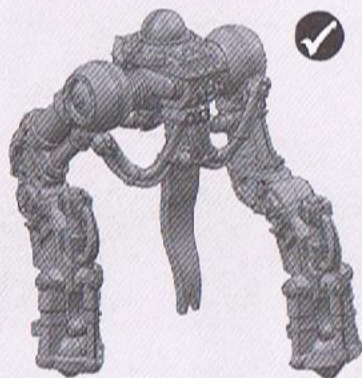
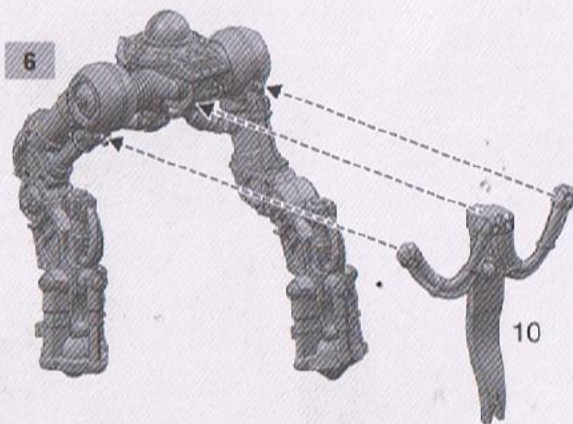

8

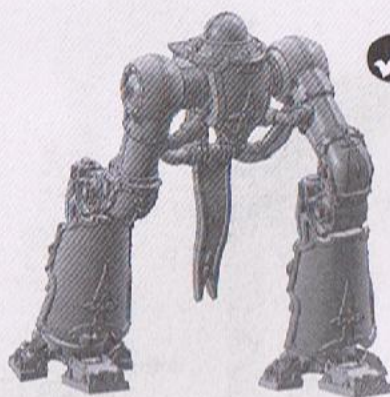
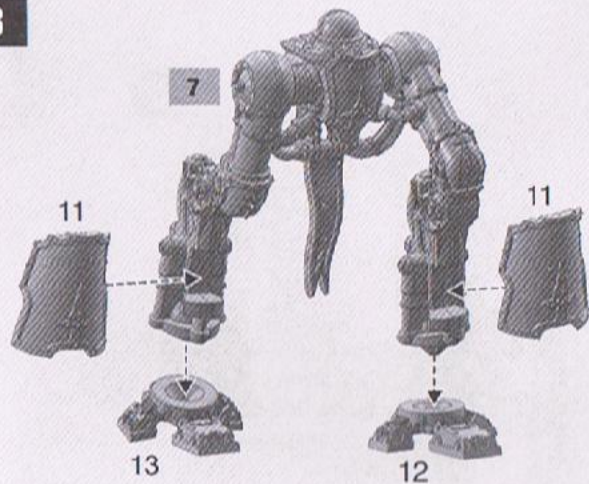

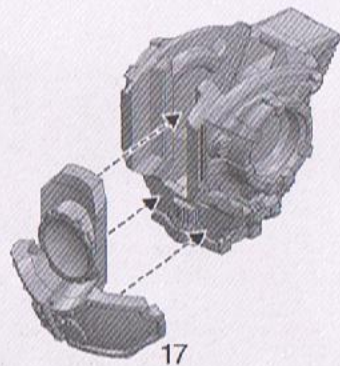
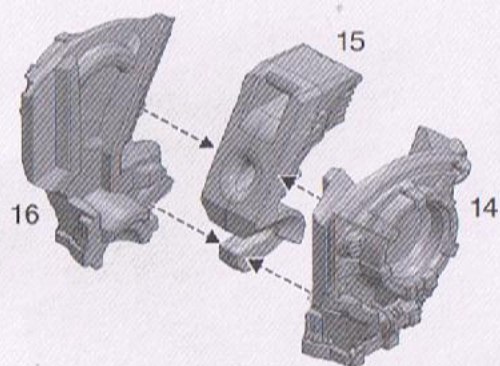
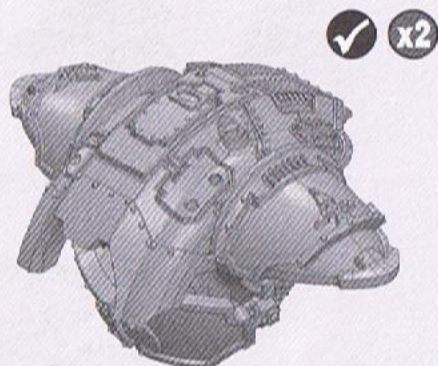
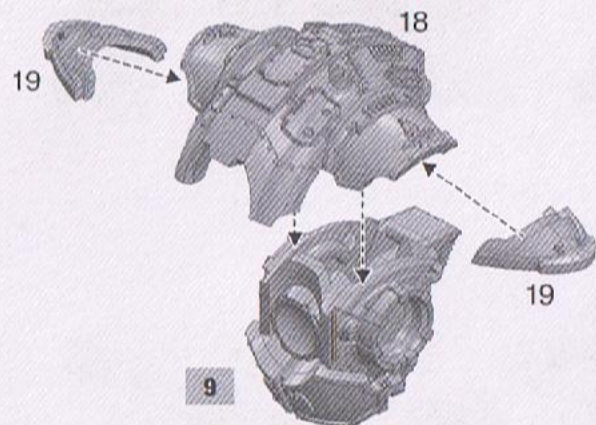
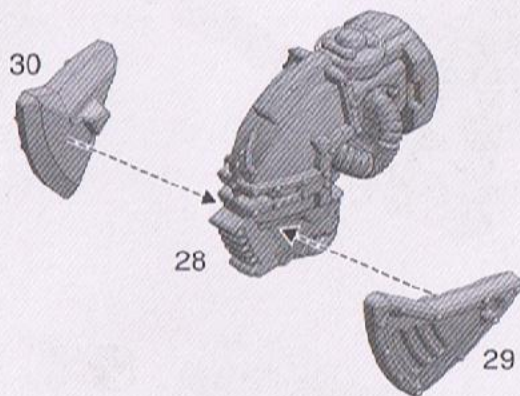
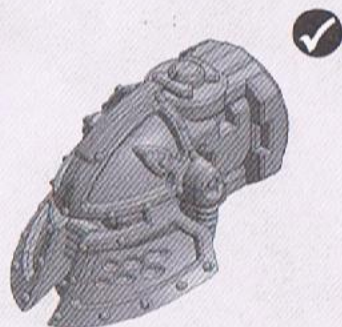
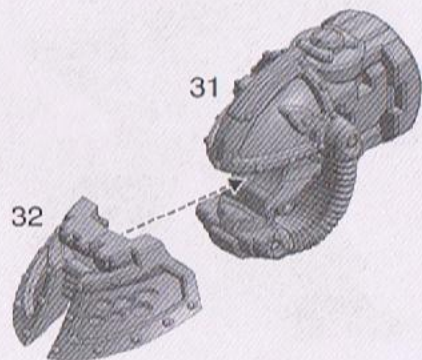
9**10****11****12**

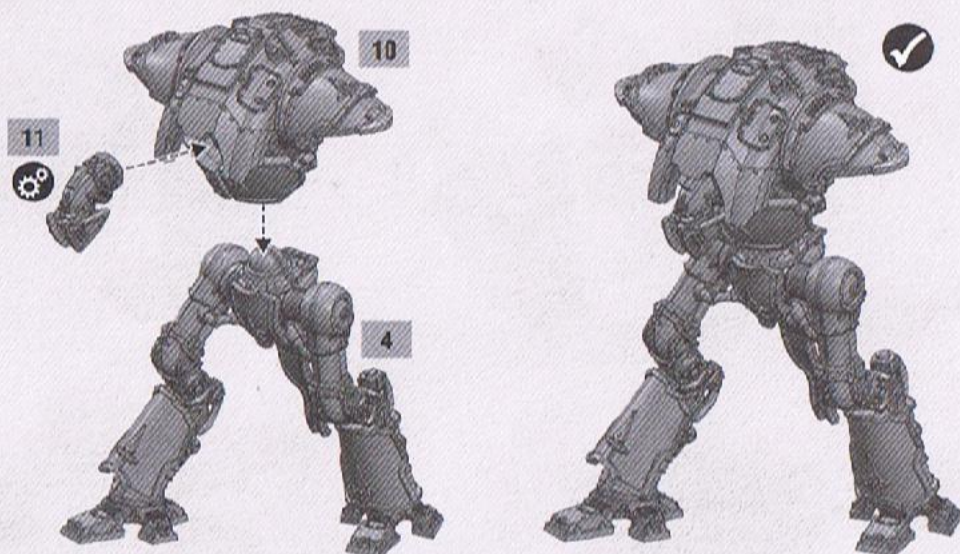
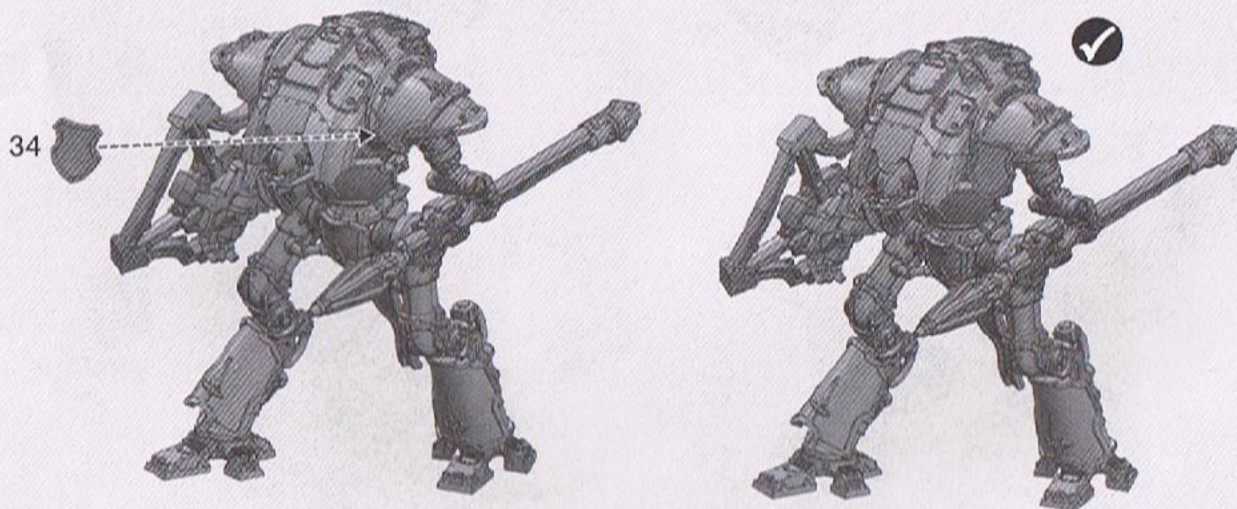
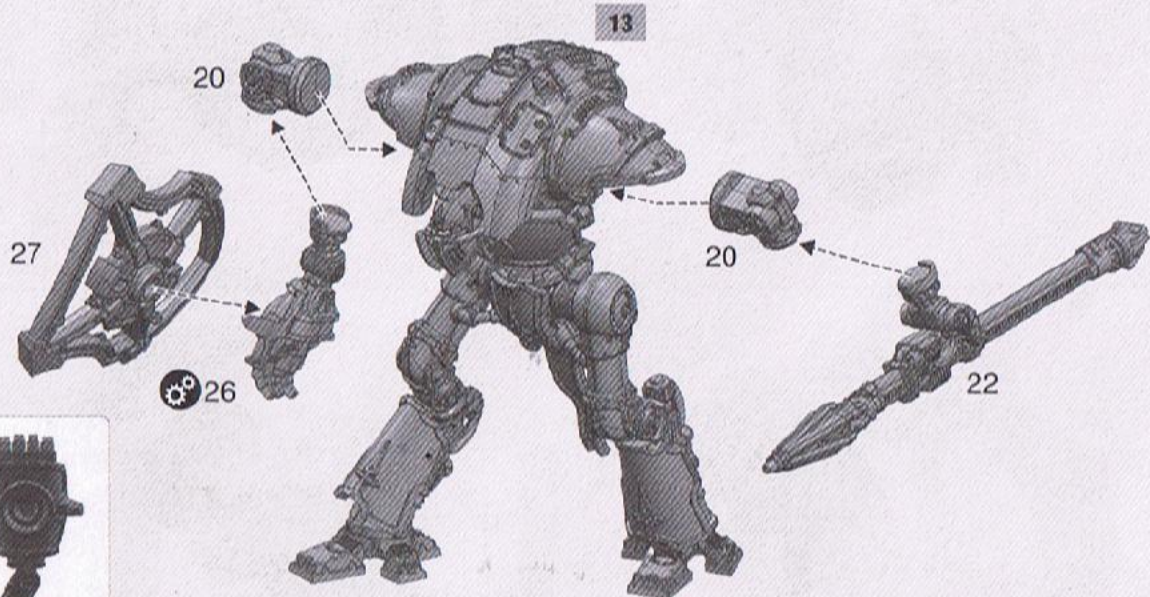
13**14**

15

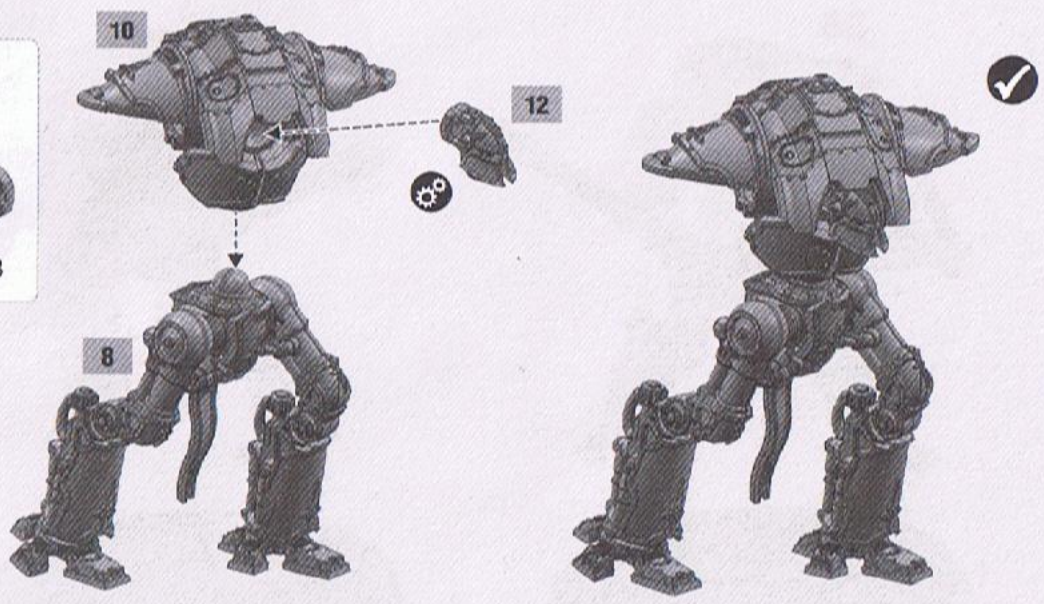

16

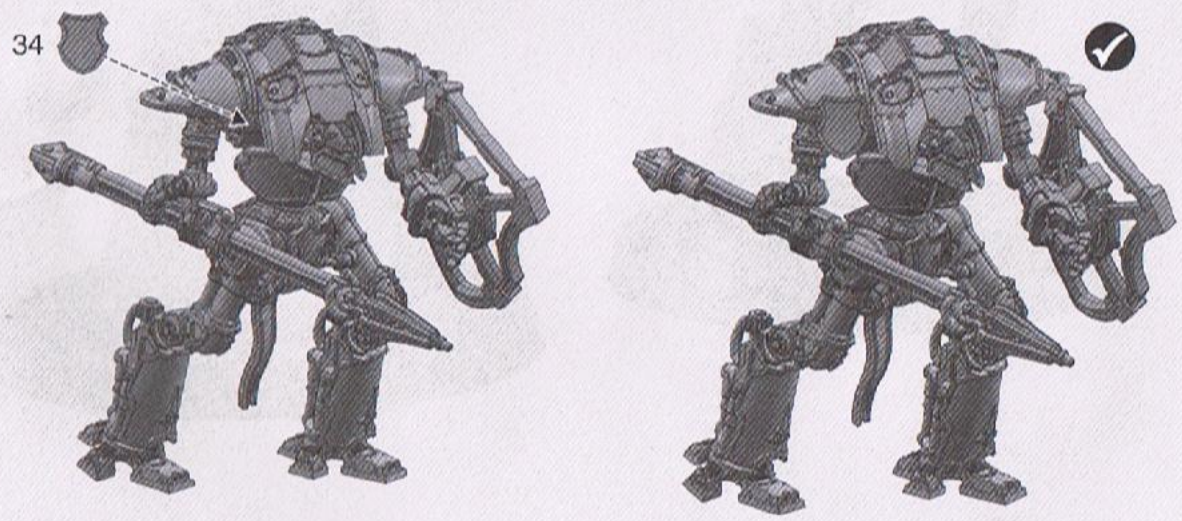
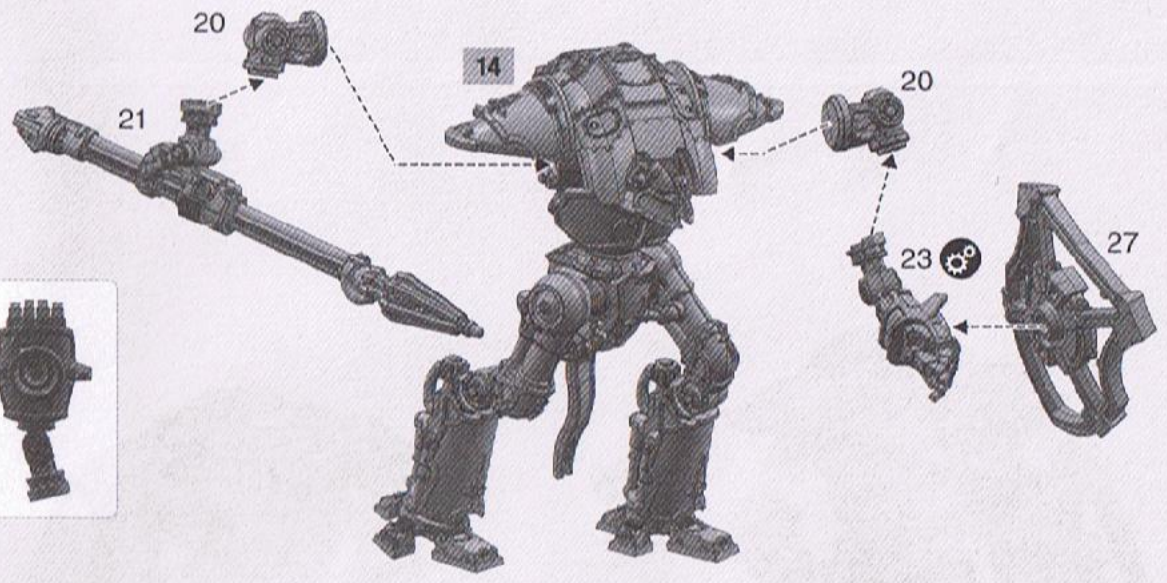

14

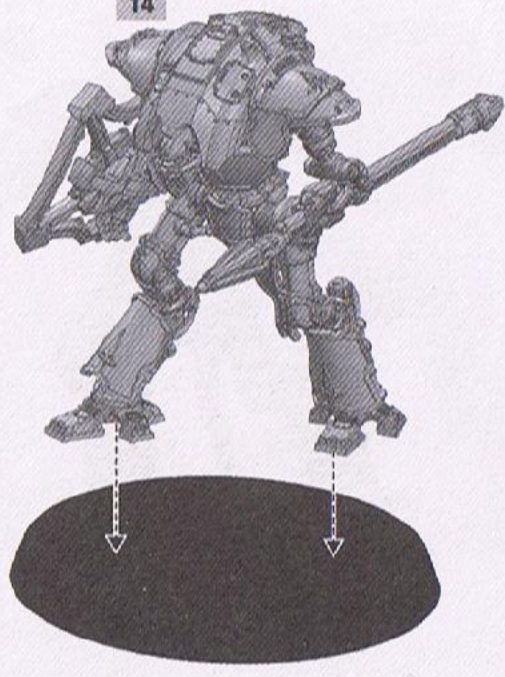

16

