



Free Downloads of Build Instructions,
Assembly Booklets & How To Guides

BuildInstructions.com

WARHAMMER 40,000

RETRIBUTOR SQUAD

ESCOUADRE RETRIBUTOR | ESCUADRA DE VENGADORAS | RETRIBUTORTRUPP
SQUADRA CASTIGANTI | リトリビューター・スカッド | 仇天使小队



! READ THIS FIRST | À LIRE EN PRIORITÉ | BITTE BEACHT E | LEE ESTO PRIMERO | LEGGI PRIMA QUESTO
最初にお読みください。 | 请优先阅读

ENG BEFORE ASSEMBLING YOUR MINIATURES, PLEASE READ THROUGH THE INSTRUCTIONS IN THIS BOOKLET CAREFULLY. A pair of plastic cutters is required to remove the plastic components in this kit from their frame. We advise using a mouldline scraping tool to clean up the parts. To assemble your model you will need plastic glue. Games Workshop sells Citadel Fine Detail Cutters, Citadel Mouldline Remover and Citadel Plastic Glue, but does not recommend these products for use by children under the age of 16 without adult supervision.





FRE AVANT D'ASSEMBLER VOS FIGURINES, VEUILLEZ LIRE ATTENTIVEMENT LES INSTRUCTIONS DE CE LIVRET. Une pince coupante est requise pour détacher chaque élément de sa grappe. Nous vous recommandons l'utilisation d'un grattoir pour ébarber les éléments. Pour l'assemblage, vous aurez également besoin de colle plastique. Games Workshop commercialise les Pinces de Précision Citadel, l'Ébarboir Citadel et la Colle Plastique Citadel, mais n'en recommande pas l'utilisation pour des enfants de moins de 16 ans sans la supervision d'un adulte.

ESP POR FAVOR, LEE CUIDADOSAMENTE ESTE LIBRETO DE INSTRUCCIONES ANTES DE EMPEZAR A MONTAR LAS MINIATURAS. Te harán falta unas tenazas para plástico a fin de separar las piezas de la matriz. También aconsejamos una herramienta para rebabas a fin de limpiar cada pieza. Para montar la miniatura necesitarás pegamento para plástico. Games Workshop vende Tenazas Citadel, Herramientas para rebabas Citadel y Pegamento para plástico Citadel, pero no recomienda estos productos a menores de 16 años sin la supervisión de un adulto.

GER VOR DEM ZUSAMMENBAU DER MINIATUREN BITTE DIE ANWEISUNGEN IN DIESER ANLEITUNG AUFMERKSAM DURCHLESEN. Du benötigst einen Kunststoffseitenschneider, um die Kunststoffbauteile aus dem Gussrahmen herauszutrennen, und Kunststoffkleber, um die Miniatur zusammenzubauen. Außerdem empfehlen wir, die Bauteile vorher mit einem Gussgratentferner zu säubern. Games Workshop bietet Präzisions-Kunststoffseitenschneider von Citadel sowie Citadel-Kunststoffkleber an, empfiehlt aber, dass Kinder unter 16 Jahren diese nur unter Aufsicht eines Erwachsenen benutzen.

ITA PRIMA DI ASSEMBLARE LE TUE MINIATURE LEGGI ATTENTAMENTE TUTTE LE ISTRUZIONI DI QUESTO LIBRETTO. Sono necessarie un paio di tronchesine per plastica per staccare i componenti dai loro sprue. Consigliamo di usare un attrezzo apposito per pulire i componenti. Per assemblare il modello avrai bisogno di colla per plastica. Games Workshop vende Tronchesine di precisione Citadel, Attrezzo per ripulire Citadel e Colla per plastica Citadel, ma non consiglia questi prodotti ad un pubblico minore di 16 anni senza la supervisione di un adulto.

日本語 本キット内のフレームからプラスチックパーツを切り離すためには、ニッパーが必要です。パーツのモールドを平らにするには、専用ツールの使用をお勧めいたします。本キットの組み立てには、プラ用接着剤が必要です。ゲームワークショップはシタデル・ニッパー、プラ用接着剤、シタデル・モールドラインリムーバーを販売しておりますが、16歳以下の子供が大人の監督なしに使用するべきではありません。

- | | | |
|--|---|---|
| <ul style="list-style-type: none">  • Variant assembly • Variante d'assemblage • Variante de montaje • Bauvariante • Assemblaggio alternativo • 組み立てバリエーション • 多种组装方式 | <ul style="list-style-type: none">  • Choice of parts • Choix d'éléments • Modelos de componentes • Auswahl an Teilen • Scelta di componenti • パーツの選択 • 选择部件 | <ul style="list-style-type: none">  x2 • Repeat process • Répéter l'étape • Repetir pasos • Vorgang wiederholen • Ripeti il processo • 同じ作業を繰り返すこと • 重复步骤 |
| <ul style="list-style-type: none">  • Special instruction - Please read • Instructions spéciales - Lire attentivement • Instrucción especial: Por favor, léela • Besondere Anweisung - Bitte lesen • Istruzioni speciali - Leggi attentamente • 特記事項 - 必ずお読みください • 特殊说明 - 请详阅 | <ul style="list-style-type: none">  • Stage complete • Étape terminée • Paso completado • Schritt abgeschlossen • Fase completa • このステージの完成 • 完成 | |

CONTENTS | CONTENU | CONTENIDO | INHALT | CONTENUTO | コンテンツ | 内含板件

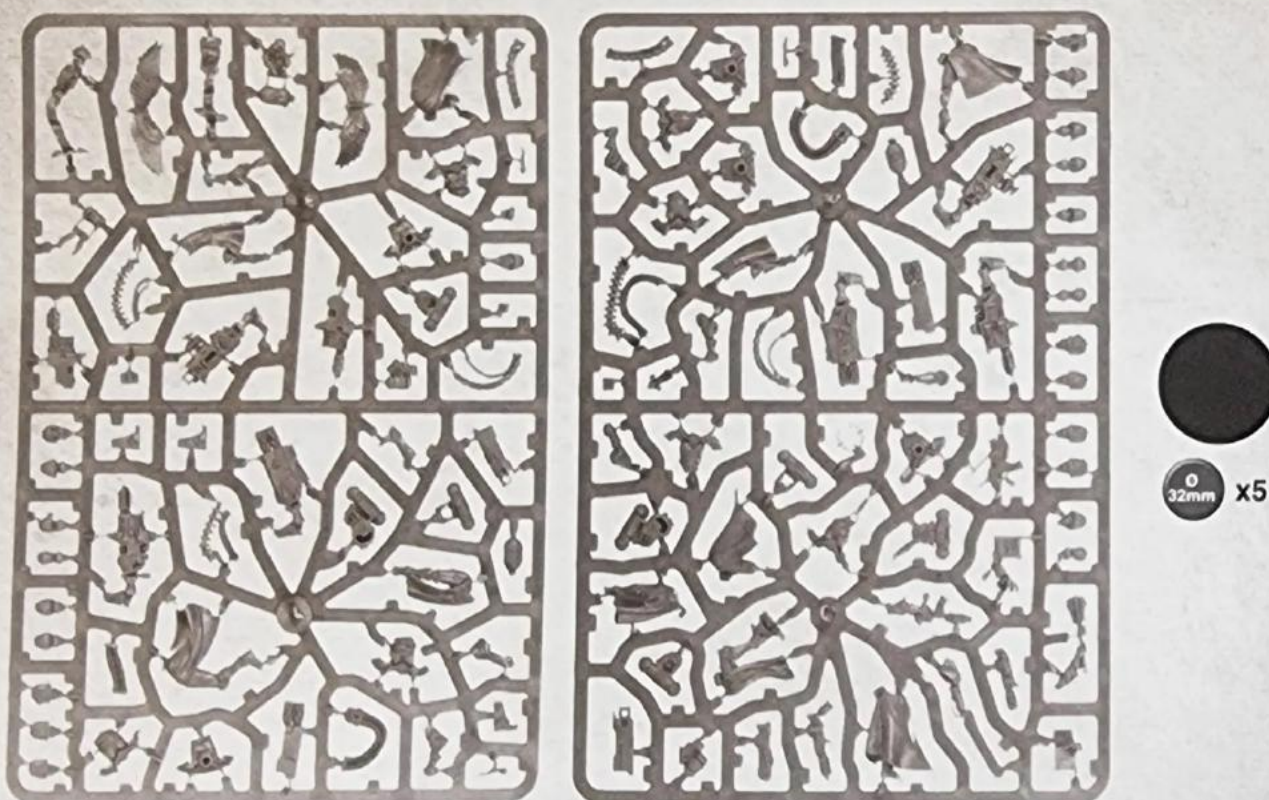

 BUILD VARIANTS | VARIANTES D'ASSEMBLAGE | VARIANTES DE MONTAJE | BAUVARIANTEN
 VARIANTI D'ASSEMBLAGGIO | バリエーション | 变体版

-  • Assemblies for build variants are colour coded.
- Les assemblages de variantes ont un code couleur.
- Las instrucciones para montajes alternativos se indican con un color diferente.
- Optionen für Bauvarianten sind farblich markiert.
- Le diverse varianti d'assemblaggio sono divise per colore.
- バリエーション違いの組み立ては色分けされている。
- 变体版拼装部件有颜色区分。



1 a



1 b



1 c



1 b



88



1 c



91

92

93

90

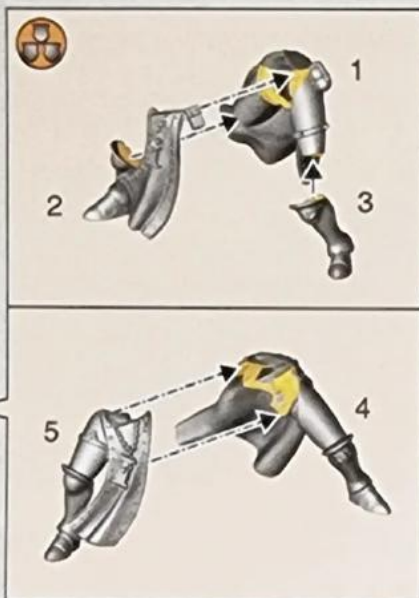
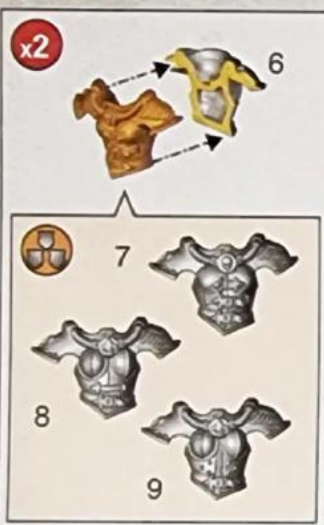
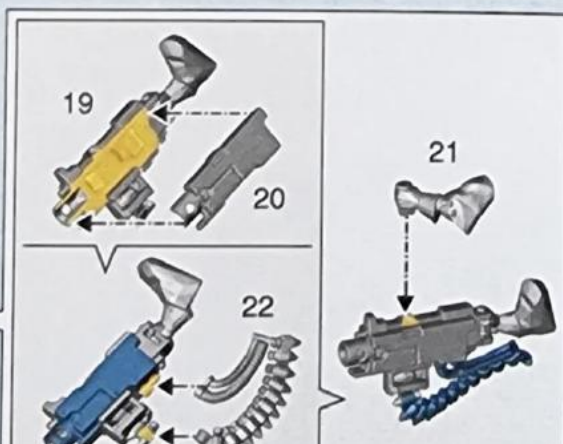
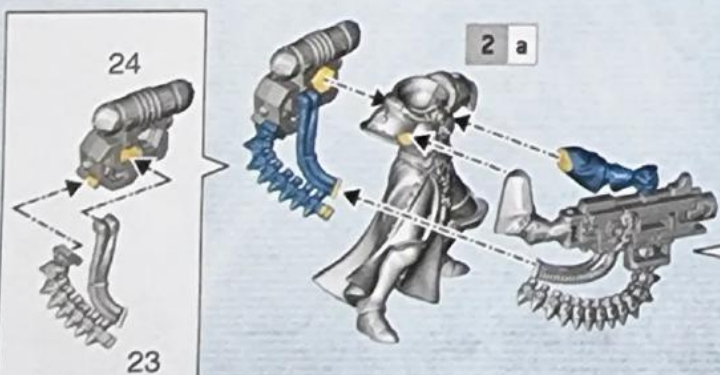

1 d**2 - 6****RETRIBUTOR SQUAD**ESCUADE RETRIBUTOR
SQUADRA CASTIGANTIESCUADRA DE VENGADORAS
リトリビューター・スカッドRETRIBUTORTRUPP
仇天使小队**2 a****2 b****2 c****2 d****2 b**

2 c

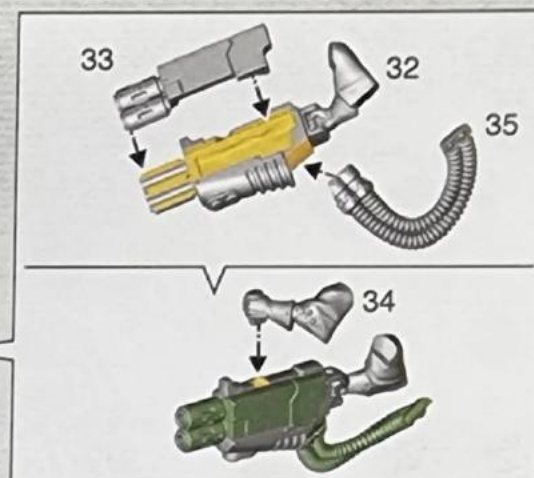
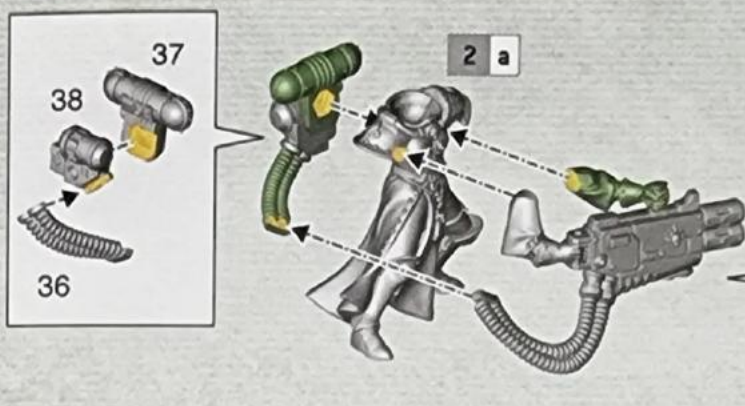

2 d

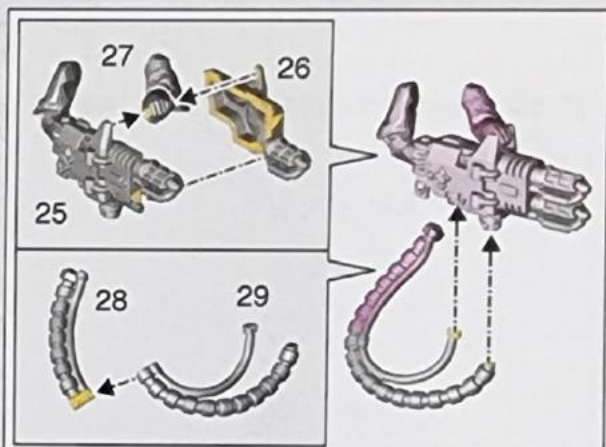
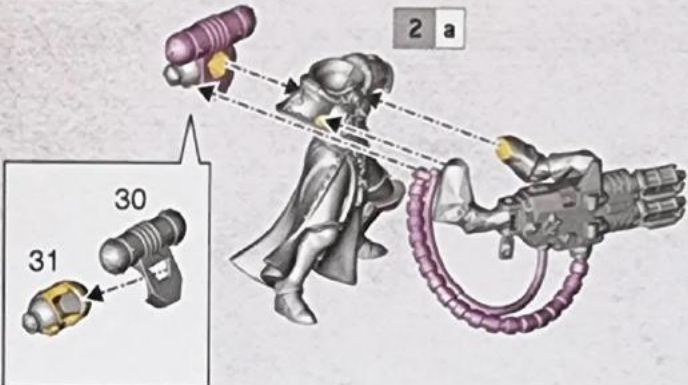

2 e

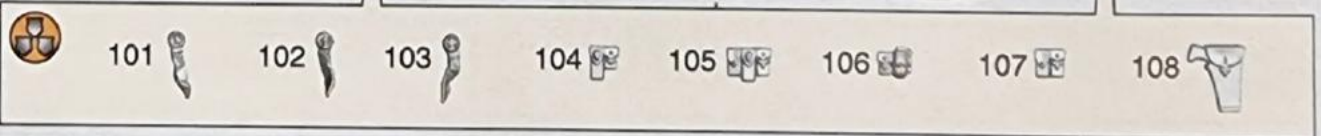

3 a



3 b

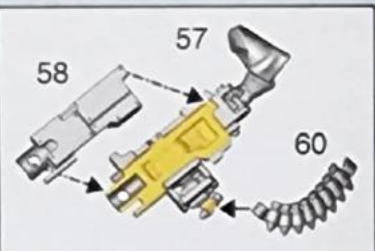
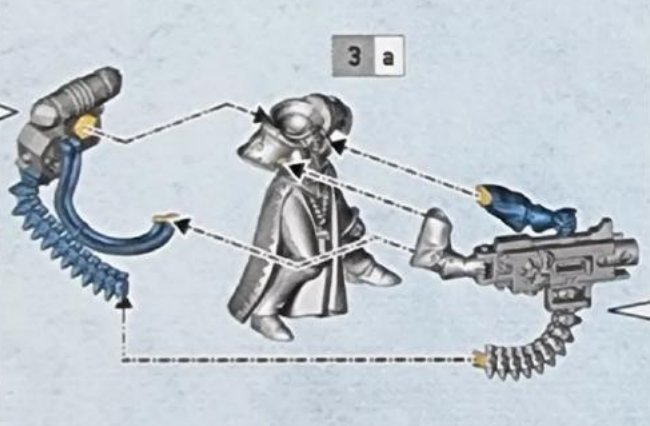

3 c

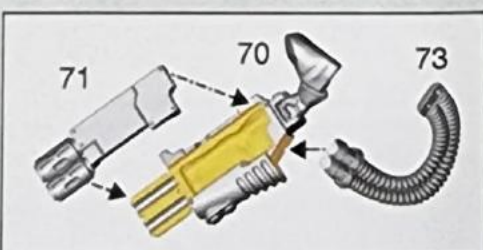
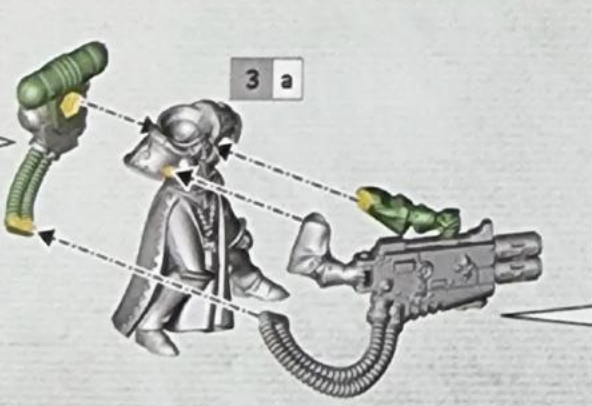
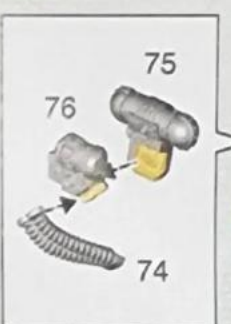

3 d

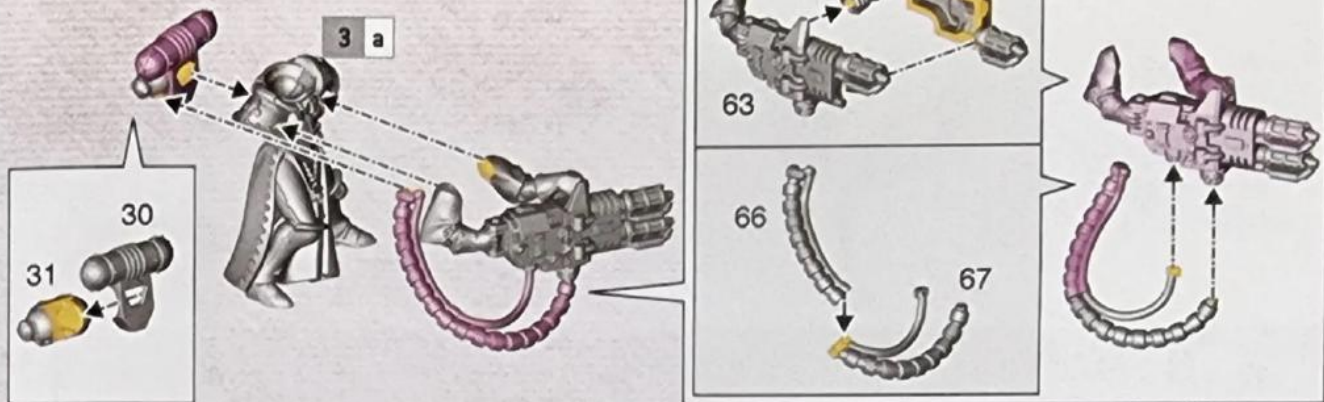

3 e

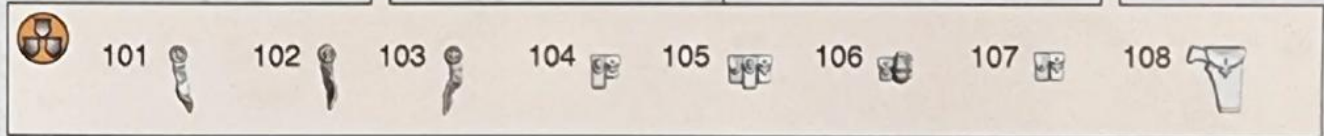
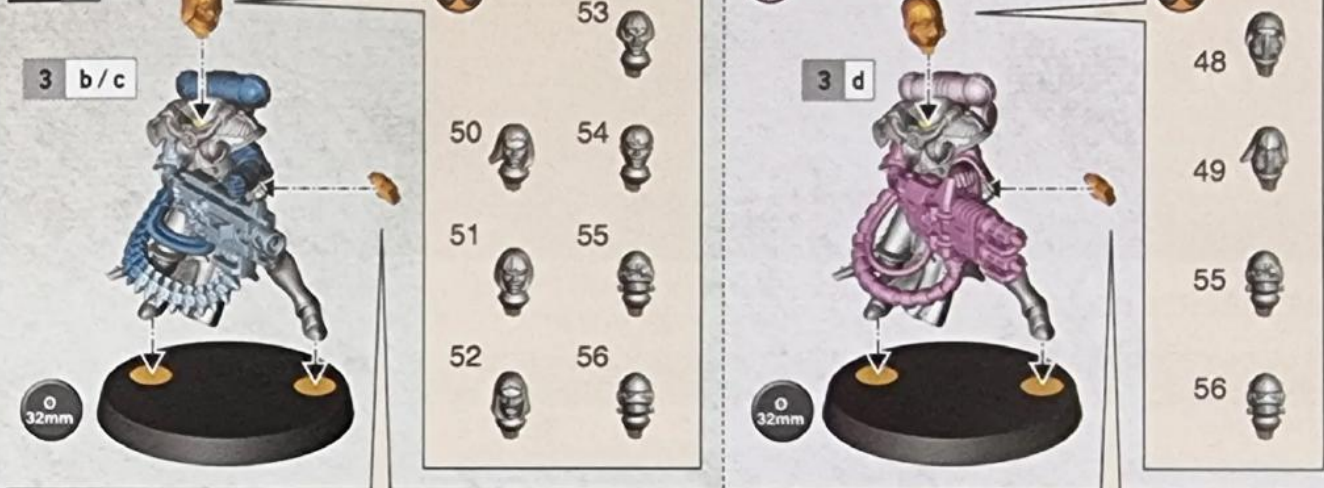

4

